



**ATTP 3-11.36  
MCRP 10-10E.1  
(Formerly MCRP 3-37B)  
NTTP 3-11.34  
AFTTP(I) 3-20.70**

---

**MULTI-SERVICE TACTICS, TECHNIQUES, AND  
PROCEDURES FOR CHEMICAL, BIOLOGICAL,  
RADIOLOGICAL, AND NUCLEAR ASPECTS OF  
COMMAND AND CONTROL**

---

**July 2010**

**DISTRIBUTION RESTRICTION A:** Approved for public release; distribution is unlimited.

CD&I (C 116)

2 May 2016

ERRATUM

to

MCRP 3-37B

MULTI-SERVICE TACTICS, TECHNIQUES, AND  
PROCEDURES FOR CHEMICAL, BIOLOGICAL, RADIOLOGICAL,  
AND NUCLEAR ASPECTS OF COMMAND AND CONTROL

1. Change all instances of MCRP 3-37B, *Multi-Service Tactics, Techniques, and Procedures for Chemical, Biological, Radiological, and Nuclear Aspects of Command and Control*, to MCRP 10-10E.1, *Multi-Service Tactics, Techniques, and Procedures for Chemical, Biological, Radiological, and Nuclear Aspects of Command and Control*.

2. File this transmittal sheet in the front of this publication.

PCN 144 000127 80

## Foreword

This publication has been prepared under our direction for use by our respective commands and other commands as appropriate.



**LESLIE C. SMITH**  
Brigadier General, USA  
Commandant  
U.S. Army Chemical, Biological, Radiological,  
and Nuclear School



**GEORGE J. FLYNN**  
Lieutenant General, USMC  
Deputy Commandant for  
Combat Development and Integration



**WENDI B. CARPENTER**  
Rear Admiral, USN  
Commander  
Navy Warfare Development Command



**MAX E. KIRSCHBAUM**  
Colonel, USAF  
Commander  
Headquarters Air Force Civil Engineer  
Support Agency

This publication is available through U.S. Army Web sites at Army Knowledge Online <[www.us.army.mil](http://www.us.army.mil)> and General Dennis J. Reimer Training and Doctrine Digital Library <[www.train.army.mil](http://www.train.army.mil)>; U.S. Marine Corps Web site at <<https://www.doctrine.usmc.mil>>; U.S. Navy Web sites at <<https://ndls.nwdc.navy.mil>> and <<https://ndls.nwdc.navy.smil.mil>>; and U.S. Air Force Web site at <[www.e-publishing.af.mil](http://www.e-publishing.af.mil)>.

**\*ATTP 3-11.36**  
**MCRP 3-37B**  
**NTTP 3-11.34**  
**AFTTP(I) 3-20.70**

Army Tactics, Techniques, and Procedures  
No. 3-11.6

Headquarters, Department of the Army  
Washington, DC

Marine Corps Reference Publication  
No. 3-37B

Marine Corps Combat Development Command  
Quantico, VA

Navy Tactics, Techniques, and Procedures  
3-11.34

Navy Warfare Development Command  
Newport, RI

Air Force Tactics, Techniques, and Procedures  
(Instruction)  
3-20.70

Headquarters, Air Force Civil Engineer Support Agency  
Tyndall Air Force Base, FL

**12 July 2010**

# **Multi-Service Tactics, Techniques, and Procedures for Chemical, Biological, Radiological, and Nuclear Aspects of Command and Control**

## **Contents**

	<b>Page</b>
	<b>PREFACE.....vi</b>
<b>Chapter 1</b>	<b>FUNDAMENTALS OF CHEMICAL, BIOLOGICAL, RADIOLOGICAL, AND NUCLEAR COMMAND AND CONTROL ..... 1-1</b>
	Functions ..... 1-1
	Support ..... 1-2
	Shape Function ..... 1-3
	Operations Process ..... 1-4
<b>Chapter 2</b>	<b>CHEMICAL, BIOLOGICAL, RADIOLOGICAL, AND NUCLEAR ASSESSMENT ACTIVITIES ..... 2-1</b>
	Functions ..... 2-1
	Threat ..... 2-2
	Operational Environment..... 2-3

---

**Distribution Restriction:** Approved for public release; distribution is unlimited.

**\*This publication supersedes FM 3-6/AFM 105-7/FM 7-11-H, 3 November 1986, and rescinds  
FM 3-11.14/MCWP 3-37.1A/NTTP 3-11.28/AFTTP(I) 3-2.54, 28 December 2004.**

	Capability .....	2-4
	Vulnerability Assessment .....	2-5
<b>Chapter 3</b>	<b>CHEMICAL, BIOLOGICAL, RADIOLOGICAL, AND NUCLEAR PLANNING ACTIVITIES .....</b>	<b>3-1</b>
	Planning Processes .....	3-1
	Assessment Activities .....	3-3
	Automated Planning Tools .....	3-5
	Intelligence, Surveillance, and Reconnaissance Planning .....	3-6
	Targeting Process .....	3-6
	Health Service Support .....	3-7
<b>Chapter 4</b>	<b>CHEMICAL, BIOLOGICAL, RADIOLOGICAL, AND NUCLEAR PREPARATION ACTIVITIES .....</b>	<b>4-1</b>
	Intelligence, Surveillance, and Reconnaissance Operations .....	4-2
	Threat Assessment .....	4-2
	Operational Environment Assessment .....	4-2
	Capability Assessment .....	4-3
	Vulnerability Assessments .....	4-3
	Task Organization .....	4-3
	Movement .....	4-4
	Coordination and Liaison .....	4-4
	Logistics .....	4-5
	Education .....	4-5
	Training .....	4-5
	Rehearsals .....	4-6
	Exercises .....	4-6
	Health Service Support .....	4-7
<b>Chapter 5</b>	<b>CHEMICAL, BIOLOGICAL, RADIOLOGICAL, AND NUCLEAR EXECUTION ACTIVITIES .....</b>	<b>5-1</b>
	Intelligence, Surveillance, and Reconnaissance Integration .....	5-1
	Incident Management .....	5-3
	Warning and Reporting Systems .....	5-5
	Hazard Prediction and Modeling .....	5-6
	Casualty and Fatality Management .....	5-7
	Restoration Operations .....	5-7
<b>Appendix A</b>	<b>METRIC CONVERSION CHART .....</b>	<b>A-1</b>
<b>Appendix B</b>	<b>CHEMICAL, BIOLOGICAL, RADIOLOGICAL, AND NUCLEAR VULNERABILITY ASSESSMENTS .....</b>	<b>B-1</b>
<b>Appendix C</b>	<b>PLANNING PROCESSES .....</b>	<b>C-1</b>
<b>Appendix D</b>	<b>THREAT ASSESSMENTS .....</b>	<b>D-1</b>
<b>Appendix E</b>	<b>OPERATIONAL ENVIRONMENT .....</b>	<b>E-1</b>
<b>Appendix F</b>	<b>AUTOMATED CHEMICAL, BIOLOGICAL, RADIOLOGICAL, AND NUCLEAR INFORMATION MANAGEMENT SYSTEMS .....</b>	<b>F-1</b>
<b>Appendix G</b>	<b>PREPARATION ACTIVITIES .....</b>	<b>G-1</b>
<b>Appendix H</b>	<b>TECHNICAL REACHBACK AND OTHER CAPABILITIES .....</b>	<b>H-1</b>

**Appendix I U.S. ARMY CHEMICAL, BIOLOGICAL, RADIOLOGICAL, AND NUCLEAR CAPABILITIES AND EMPLOYMENT ..... I-1**

**Appendix J U.S. AIR FORCE CHEMICAL, BIOLOGICAL, RADIOLOGICAL, AND NUCLEAR CAPABILITIES AND EMPLOYMENT..... J-1**

**Appendix K U.S. MARINE CORPS CHEMICAL, BIOLOGICAL, RADIOLOGICAL, AND NUCLEAR CAPABILITIES AND EMPLOYMENT..... K-1**

**Appendix L U.S. NAVY CHEMICAL, BIOLOGICAL, RADIOLOGICAL, AND NUCLEAR CAPABILITIES AND EMPLOYMENT ..... L-1**

**Appendix M EXECUTION ACTIVITIES..... M-1**

**GLOSSARY ..... Glossary-1**

**REFERENCES .....References-1**

**INDEX..... Index-1**

## Figures

Figure 1-1. CBRN aspects of C2 ..... 1-2

Figure 1-2. CBRN operations process ..... 1-4

Figure 2-1. Vulnerability assessment process..... 2-5

Figure 3-1. Comparison of the MDMP and MCPP ..... 3-2

Figure B-1. CBRN vulnerability assessment process.....B-3

Figure B-2. Sample CBRN vulnerability analysis matrix .....B-4

Figure C-1. Mission receipt..... C-7

Figure C-2. Mission analysis ..... C-8

Figure C-3. COA comparison ..... C-16

Figure C-4. Sample CBRN annex ..... C-17

Figure D-1. Sample collection plan ..... D-5

Figure D-2. Chemical-agent, probability-of-use estimation ..... D-8

Figure D-3. Biological-agent, probability-of-use estimation..... D-9

Figure D-4. Nuclear-weapon, probability-of-use estimation ..... D-10

Figure D-5. Radiological-weapon, probability-of-use estimation..... D-11

Figure D-6. Sample CBRN threat assessment summary..... D-12

Figure D-7. Sample CBRN incident data collection worksheet..... D-15

Figure I-1. Major force capabilities ..... I-2

Figure I-2. USA Chemical Corps CBRN operational units ..... I-3

Figure I-3. CBRN reconnaissance platoon (ICBT) (TOE 77406G100) ..... I-4

Figure I-4. CBRN reconnaissance platoon (HBCT) (TOE 87306G300)..... I-5

Figure I-5. CBRN reconnaissance platoon (SBCT) (TOE 34117F300)..... I-6

Figure I-6. CBRN reconnaissance platoon (armored) (TOE 03599FG00)..... I-7

Figure I-7. CBRN reconnaissance platoon (light) (TOE 03599FN00)..... I-8

Figure I-8. CBRN decontamination platoon (heavy) (TOE 03599FI00) ..... I-9

Figure I-9. CBRN decontamination platoon (light) (TOE 03599FH00)..... I-10

Figure I-10. CBRN platoon (biological) (TOE 03599FL00).....	I-12
Figure I-11. CBRN platoon (obscuration) (mechanized) (TOE 03599FJ00).....	I-13
Figure I-12. CBRN platoon (obscuration) (wheeled) (TOE 03599FK00).....	I-14
Figure I-13. CBRN company (MANSPT) (TOE 03410F000).....	I-15
Figure I-14. CBRN company (area support) (TOE 03420F300).....	I-16
Figure I-15. CBRN company (obscuration) (mechanized) (TOE 03440F100).....	I-17
Figure I-16. CBRN company (obscuration) (wheeled) (TOE 03440F200).....	I-18
Figure I-17. CBRN company (biological) (TOE 03470F000).....	I-19
Figure I-18. CBRN company (Armored Cavalry Regiment) (TOE 03377L200).....	I-20
Figure I-19. CBRN battalion (TOE 03496F000).....	I-21
Figure I-20. CBRN brigade headquarters (TOE 03492F000).....	I-22
Figure I-21. CBRNE battalion and company (technical escort) (TOE 03636G000 and TOE 03537GA00).....	I-23
Figure I-22. CBRN-CE .....	I-28
Figure J-1. USAF national CBRN reporting chain of command.....	J-4
Figure K-1. MAGTF CBRN organization.....	K-2
Figure K-2. MAGTF CBRN operational units.....	K-3
Figure K-3. CBRN reconnaissance platoon (MAGTF CBRN consequence set).....	K-7
Figure K-4. Future mobile CBRN reconnaissance platoon.....	K-8
Figure K-5. CBRN decontamination platoon.....	K-9
Figure K-6. CBRNCC.....	K-18
Figure K-7. CBRNCC coordination within the Marine expeditionary force.....	K-22
Figure K-8. CBRN reconnaissance coordination within the Marine expeditionary force.....	K-23
Figure K-9. CBRN decontamination coordination within the Marine expeditionary force.....	K-24
Figure L-1. Navy emergency management command structure .....	L-3
Figure M-1. Commander’s role .....	M-1

## Tables

Table 3-1. Operations process assessment tasks.....	3-5
Table 3-2. Sample target folder content.....	3-7
Table A-1. Metric conversion chart .....	A-1
Table C-1. Process comparison.....	C-18
Table D-1. CBRN threat assessment and conditions matrix .....	D-6
Table D-2. Information accuracy questions .....	D-15
Table D-3. CBRN threat assessment checklist questions .....	D-16
Table D-4. Crime/banditry threat.....	D-19
Table D-5. Indirect CBRN threat.....	D-20
Table D-6. Direct CBRN threat .....	D-21
Table D-7. Additional enemy indicators .....	D-22
Table E-1. Functional staff interfaces .....	E-4

Table E-2. Physical-environment variables .....	E-7
Table E-3. Weather effects on aerosol chemical agents.....	E-10
Table E-4. Weather effects on biological-agent dissemination .....	E-13
Table H-1. Technical reachback contact information .....	H-1
Table I-1. CBRN section core functions .....	I-24
Table K-1. CBIRF tactical data.....	K-4
Table K-2. CBRN reconnaissance platoon (NBC reconnaissance system).....	K-6
Table K-3. Subordinate command reconnaissance members .....	K-8
Table K-4. MSC decontamination teams.....	K-10
Table K-5. MSC decontamination team members .....	K-10
Table K-6. CBRN special staff responsibilities .....	K-15
Table K-7. MAGTF command element CBRNCC .....	K-19
Table K-8. MSC CBRNCC.....	K-20



# Preface

## SCOPE

This multi-Service publication represents a significant revision of the November 1986 publication. The scope of the previous publication was limited to the effect that weather and terrain have on nuclear, biological, and chemical (NBC) operations and obscuration operations. This publication expands that scope to include the doctrinal employment of chemical, biological, radiological, and nuclear (CBRN) capabilities (organizations, personnel, technology, and information) to characterize CBRN threats and hazards, including toxic industrial material (TIM), to the commander and the force. It is designed to provide commanders and staffs at the operational and tactical levels with capability employment planning data and considerations to shape military operations involving CBRN threats and hazards (CBRN shape) and a better understanding of where and when to expect CBRN hazards by applying information management (IM) to the military decisionmaking process (MDMP)/Marine Corps planning process (MCP). This publication incorporates the characteristics of CBRN shape as addressed in joint concepts and in doctrine; and it provides doctrine and tactics, techniques, and procedures (TTP) for managing CBRN threats and hazards in the larger context of multi-Service military operations. The chapters present a doctrinal foundation, and specific TTP are included in appendixes. This manual also incorporates the joint doctrine elements for combating weapons of mass destruction (WMD), to include the passive defense capabilities of CBRN shape, CBRN sense, CBRN shield, and CBRN sustain. During military operations, this publication is subordinate to current joint publications (JPs) addressing this topic. This document incorporates the following key guidance—

- National strategy to combat WMD.
- National military strategy to combat WMD.
- Department of Defense (DOD) protection joint functional concept.
- Joint enabling concept for CBRN defense.
- JP 3-40.

## PURPOSE

The purpose of this publication is to provide commanders, staffs, key agencies, and Service members with a key reference for understanding, characterizing, and managing CBRN threats and hazards in a particular operational environment (OE). This manual bridges the gap between Service and joint doctrine. It contains TTP for commanders and staff to use for characterizing and managing CBRN threats and hazards while conducting multi-Service military operations. This manual addresses concepts, principles, fundamentals, planning, operational considerations, and training and support functions. It serves as the foundation for developing Service manuals and refining existing training support packages, mission training plans, training center and unit exercises, and Service school curricula. It drives the examination of organizations and materiel developments applicable to military support of CBRN aspects of command and control (C2).

## APPLICATION

This publication is designed for use at the operational and tactical levels but has implications at the strategic level in the implementation of CBRN supporting strategic objectives. The manual will support command staffs, CBRN staff officers, CBRN noncommissioned officers (NCOs), non-CBRN personnel performing collateral duties as additional-duty CBRN officers or NCOs, and employees of civilian agencies in the assessment, planning, preparation, and execution of CBRN C2 functions. This publication is intended to provide multi-Service C2 concepts and considerations for planning for, responding to, and recovering from CBRN events. It is not stand-alone guidance for United States (U.S.) Air Force (USAF) CBRN actions and activities. It is applicable to USAF units and USAF teams only in conjunction with appropriate USAF-specific publications, installation plans, supporting checklists, and other appropriate guidance.

## IMPLEMENTATION PLAN

Participating Service command offices of primary responsibility will review this publication, validate the information, and reference and incorporate it into Service and command manuals, regulations, and curricula as follows:

- **Army.** The U.S. Army (USA) will incorporate the procedures in this publication in USA training and doctrinal publications as directed by the commander, U.S. Army Training and Doctrine Command (TRADOC). Distribution is according to the Department of the Army (DA) Form 12-99-R (Initial Distribution Requirements for Publications).
- **Marine Corps.** The U.S. Marine Corps (USMC) will incorporate the procedures in this publication in training and doctrinal publications as directed by the Commanding General, Marine Corps Combat Development Command. Distribution is according to the USMC Publications Distribution System.
- **Navy.** The U.S. Navy (USN) will incorporate the procedures in this publication in training and doctrinal publications as directed by the Commander, Navy Warfare Development Command. Distribution is according to the military standard requisitioning and issue procedure desk guide.
- **Air Force.** The USAF will incorporate the procedures in this publication in USAF training and doctrinal publications as directed by the Air Staff. Distribution is according to the Department of the USAF Publications Distribution System.

## PROGRAM PARTICIPANTS

The following commands and agencies participated in the development of this publication:

- **Joint.** Joint Requirements Office—Chemical, Biological, Radiological, and Nuclear Defense, 401 MANSCEM Loop, Suite 1309, Fort Leonard Wood, Missouri 65473.
- **Army.** TRADOC, Fort Monroe, Virginia, 23651.
- **Marine Corps.**
  - USMC, Combat Development Command, 3300 Russell Road, Suite 204, Quantico, Virginia 22134-5021.
  - USMC, CBRN Defense Test and Evaluation Coordination Office/School, 1273 Iowa Ave, Fort Leonard Wood, Missouri 65473.
- **Navy.** Navy Warfare Development Command, Newport, Rhode Island 02841-1207.
- **Air Force.** Headquarters Air Force Civil Engineer Support Agency, Tyndall Air Force Base, Florida 32403-5319.

## USER INFORMATION

A brief description of each chapter and appendix follows:

- Chapter 1 introduces Service commanders and their staffs at the tactical level to the important aspects of the joint and Service C2 functions. It does not cover staffs of units at echelons above corps and joint level.
- Chapter 2 provides an overview of the OE. It introduces the joint OE variables of political, military, economic, social information, and infrastructure, with two added variables used by the USA—physical environment and time—as translated into concepts for use by CBRN staffs, units, and individuals at the tactical level.
- Chapter 3 provides an overview of CBRN tactical planning considerations for the MDMP/MCPP. This section is not intended to replace Service guidance, but to highlight some CBRN-related considerations of the planning process that apply to staffs, units, and sections during operations.
- Chapter 4 examines the importance of preparedness activities, including key education, training, rehearsal, exercise, and health service support (HSS) considerations. Preparation requires the steady infusion of new tactical TTP, concept of operations (CONOPS), and standardized leadership protocols.

- Chapter 5 provides an overview of execution activities and describes how the fusion of these capabilities with decision support tools enables forces to recognize CBRN threats and hazards. This chapter also provides CBRN IM processes, activities, and capabilities.
- Appendix A is a metric conversion chart that is included according to Army Regulation (AR) 25-30.
- Appendix B provides tools for determining risks associated with vulnerabilities to a CBRN attack. It also provides the user with suggested TTP to mitigate and reduce these vulnerabilities.
- Appendix C provides tools to assist in moving the MDMP/MCPP process from concept to execution.
- Appendix D provides TTP for conducting threat assessments by CBRN staffs, units, and individuals at the tactical level.
- Appendix E describes the vertical linkages for use by CBRN staffs, units, and individuals at the tactical level. Political, military, economic, social, information, infrastructure–physical environment and time (PMESII-PT) is translated into mission, enemy, terrain and weather, troops and support available, time available, and civil considerations (METT-TC).

---

*Note.* The USMC mission, enemy, terrain and weather, troops and support available, and time available (METT-T). Civilian considerations are inherently measured within the context of this acronym.

---

- Appendix F identifies programs and emerging capabilities of the Joint Program Executive Officer for Chemical and Biological Defense (JPEO-CBD) and the Joint Program Manager for Information Systems (JPM-IS).
- Appendix G provides tools to ensure that controls are converted into clear, simple execution orders that are understood at all levels. The CBRN staff officer must manage knowledge and store, retrieve, filter, fuse, and display information from a variety of sources in context to ensure that the right information reaches the right decisionmaker in an actionable format to support superior decisionmaking.
- Appendix H provides an overview of the subject matter expert (SME) capabilities available when a technical issue exceeds the tactical unit or CBRN staff capability.
- Appendix I provides an overview of the capabilities that USA CBRN units and staffs provide to the commander.
- Appendix J provides an overview of the capabilities that USAF CBRN units and staffs provide to the commander.
- Appendix K provides an overview of the capabilities that USMC CBRN units and staffs provide to the commander.
- Appendix L provides an overview of the capabilities that USN chemical, biological, and radiological (CBR) units and staffs provide to the commander.
- Appendix M provides an overview of execution activities which support the CBRN information transfer technologies that develop the CBRN common operational picture (COP) and IM with timely, accurate, and evaluated information on contamination from CBRN attacks and incidents.

This publication applies to the Active Army, the Army National Guard (ARNG)/Army National Guard of the United States (ARNGUS), and the United States Army Reserve (USAR) unless otherwise stated.

The U.S. Army Chemical, Biological, Radiological, and Nuclear School (USACBRNS) developed this publication with the joint participation of the approving Service commands.

We encourage recommended changes for improving this publication. Please reference changes by specific page and paragraph, and provide a rationale for each recommendation. Send Army comments and recommendations on DA Form 2028 (*Recommended Changes to Publications and Blank Forms*) directly to—

- **Army**  
Commandant  
U.S. Army Chemical, Biological, Radiological, and Nuclear School  
ATTN: ATSN-CM-DD  
401 MANSCEN Loop, Suite 2617  
Fort Leonard Wood, MO 65473-8926  
Commercial (573) 596-0131, extension 3-7364  
DSN 676-7364  
Web site: <<https://www.us.army.mil/>>

Send other military branch comments and recommendations directly to—

- **Marine Corps**  
Deputy Commandant for Combat Development and Integration  
ATTN: MCCDC CDD MID DCB C116  
3300 Russell Road, Suite 204  
Quantico, VA 22134-5021  
DSN 278-6233; Commercial (703) 784-6233  
Web site: <<https://www.doctrine.usmc.mil/>>
- **Navy**  
Commander  
Navy Warfare Development Command  
ATTN: N5  
686 Cushing Road  
Newport, RI 02841-1207  
DSN 948-4201; Commercial (401) 841-4201  
Web site: <<https://www.nko.navy.mil/>>
- **Air Force**  
Headquarters Air Force Civil Engineer Support Agency  
ATTN: CEXR  
139 Barnes Drive, Suite 1  
Tyndall Air Force Base, FL 32403-5319  
DSN 523-6173; Commercial (850) 283-6173  
Web site: <<http://afpubs.hq.af.mil/>>

Unless this publication states otherwise, masculine nouns and pronouns do not refer exclusively to men.

**This page intentionally left blank.**

## Chapter 1

# Fundamentals of Chemical, Biological, Radiological, and Nuclear Command and Control

State and nonstate actors have long sought to acquire and use CBRN weapons against the United States and its allies. The threat is increasingly serious and complex as these weapons are now more readily available and harder to detect. The U.S. military must be diligent in protecting its assets from the effects of CBRN incidents. Effective C2 requires the integration with hazards planning, preparation, and execution—along with continuous assessment activities—to prevent CBRN incidents from occurring; to protect personnel, equipment, and information during a CBRN incident response; and to mitigate/recover from a CBRN incident that involves casualties and/or contamination.

## FUNCTIONS

1-1. C2 is the exercise of authority and direction by a properly designated commander over assigned and attached forces in the accomplishment of the mission:

- **Command.** Command is the authority that a commander in the armed forces lawfully exercises over subordinates by virtue of rank or assignment. Command includes the authority and responsibility for effectively using available resources and for planning the employment of, organizing, directing, coordinating, and controlling military forces for the accomplishment of assigned missions. It also includes responsibility for health, welfare, morale, and discipline of assigned personnel.
- **Control.** Control is the regulation of forces and functions to accomplish the mission according to the commander's intent. It includes collecting, processing, displaying, storing, and disseminating relevant information for creating the COP and using information—primarily by the staff—to synchronize operations through a process. Control allows commanders to disseminate their intent, execute decisions, and adjust their operations to reflect changing reality and enemy actions. It allows commanders to modify their visualization to account for changing circumstances. Control also allows commanders to identify times and points requiring new decisions (decision points) during preparation and execution.

1-2. The CBRN C2 function encompasses the related tasks and systems that support commanders in exercising authority and direction in CBRN environments. It includes those tasks associated with acquiring friendly and adversarial CBRN capabilities information, managing relevant information, and directing and leading subordinates. (See figure 1-1, page 1-2, for an illustration of the CBRN aspects of C2.)

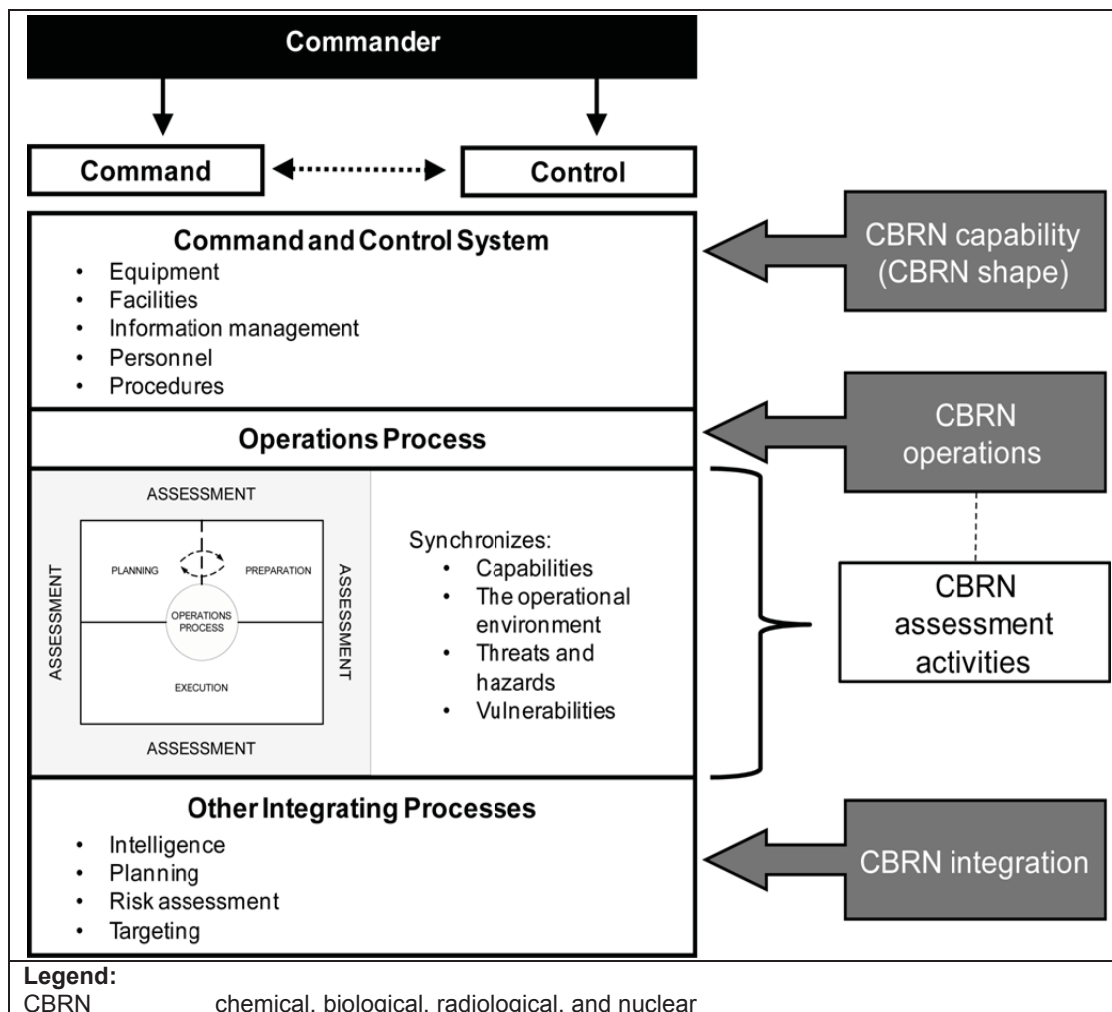

Figure 1-1. CBRN aspects of C2

## SUPPORT

1-3. C2 has two components: the commander and the C2 system. CBRN information systems include communications systems, prediction and modeling systems, and integrated detection networks; and they support the commander's overall C2 system. CBRN information systems contribute to the prevention of a CBRN incident and the protection of the commander's assets and capabilities. CBRN staffs collaborate with the commander and other staff sections supporting the commander's intent to direct units and control resource allocations. They are alert for enemy or friendly situations that require command decisions and advise commanders concerning them.

1-4. The C2 information system provides the commander a secure, real-time/near-real-time COP of the CBRN hazard environment within the context of the OE. This capability fuses information from the integrated early warning, hazard analysis, and other supporting sources, to include meteorological, terrain, intelligence, coalition allies, and civil support information. This capability supports timely decisionmaking related to situational awareness (SA); protection; the restoration of operating tempo; and casualty treatment, care, and evacuation.



## SHAPE FUNCTION

1-5. The CBRN shape function is fundamental to C2, and supports CBRN passive defense capabilities through the integration of CBRN sense, CBRN shield, and CBRN sustain functions. CBRN incident characterization enhances situational understanding by enabling commanders to develop a clear understanding of the current and predicted CBRN hazard situation and visualize the sequence of events that move an installation or deployed force from its current state to the desired end state. It allows commanders to make informed decisions regarding the use of counterproliferation components of interdiction operations, offensive operations, active defense operations, elimination operations, and passive defense operations to characterize CBRN threats and hazards while conducting multi-Service military operations.

1-6. Significant capabilities of the CBRN shape function are—

- **Intelligence.** This capability provides multidisciplined, all-source, fused intelligence tools for assessing the enemy situation, environment, and civil considerations. The objective is to develop a clear definition, understanding, and appreciation of potential CBRN threats and hazards, to including disease surveillance and injuries.
- **Assessment.** This capability provides an all-hazards approach that ensures interoperability; promotes the effective use of resources; and protects critical operations, personnel, assets, and the environment.
- **Integrated detection networks.** This capability provides a networked technological infrastructure/collaborative environment for sharing CBRN-related information. It consists of software segments operating on the information systems and hardware elements that provide the physical substrate for sensor connectivity and the architecture for a wired or wireless connection to the host C2 platforms.
- **Information management.** CBRN IM implements warning and reporting measures. This capability provides quality information to the right person at the right time in a usable form to facilitate understanding and decisionmaking. IM entails collecting and analyzing data from assessments within the CBRN sense, CBRN shield, and CBRN sustain functions to support CBRN counterproliferation passive defense preparations based on plans, the commander's intent, and the operational context and situation. For example, the Joint Warning and Reporting Network (JWARN) is used primarily by CBRN centers to provide joint forces and, in the future, DOD incident commanders with a single standardized CBRN defense monitoring, analysis, and response capability. JWARN provides the operational capability to collect, analyze, identify, locate, report, and disseminate information on CBRN incidents and environmental hazards.
- **Capability employment and management.** The consideration of how CBRN threats and hazards shape military operations imparts an understanding of where and when to expect CBRN hazards by applying IM to planning activities. This allows the commander to make informed use of counterproliferation components of interdiction operations, offensive operations, active defense operations, elimination operations, and passive defense operations to optimize our capability to operate in a CBRN environment.
- **Health surveillance.** This capability provides medical SA and decision support to theater commanders in support of ongoing threat assessments and medical decisionmaking and planning. Health surveillance includes the capability to—
  - Rapidly identify, report, and document CBRN agent threats through laboratory analysis in theater.
  - Conduct medical surveillance for health outcomes of operational importance and to conduct epidemiological analysis of medical events and patterns.
  - Execute preventive medicine support to food and water safety and occupational and environmental health surveillance missions in a CBRN hazard environment.
  - Conduct surveillance of indigenous animal populations to identify diseases of operational importance and information pertaining to ongoing threat assessments.
- **CBRN incident response.** This capability provides measures or actions taken to save lives, protect property, and establish control following a CBRN incident.



- **CBRN incident mitigation.** This capability provides measures or actions taken during response operations to reduce the harmful effects of the CBRN incident, decrease risks of damage, and finish restoring mission capability and essential public and government services interrupted by an event.
- **Casualty management.** This capability allows the planning, preparing, coordinating, and providing effective care and management of CBRN casualties to maximize force effectiveness by eliminating or reducing the effects of CBRN threats and hazards.

## OPERATIONS PROCESS

1-7. The CBRN operations process is continuous and consists of the major C2 activities that are performed concurrently during operations in CBRN environments. Those activities are planning, preparation, execution, and continuous assessment. (See figure 1-2 for an illustration of the CBRN operations process and chapters 2 through 5 for a thorough discussion of each key activity.)

- 1-8. The CBRN operations process serves two important functions for commanders. It—
- Provides a framework that describes the exercise of CBRN aspects of C2.
  - Provides a framework for organizing related CBRN information systems and using them to conduct operations in CBRN environments.

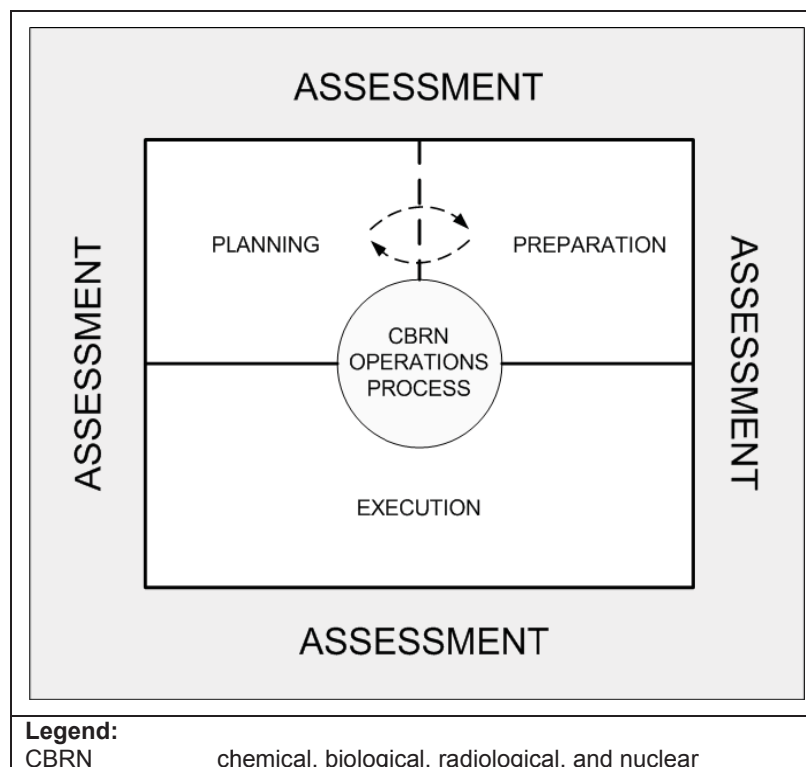

**Figure 1-2. CBRN operations process**

1-9. Commanders and staffs conduct CBRN assessments throughout planning, preparation, and execution. Commanders synchronize military operations by continuously assessing CBRN threats and hazards, the OE, CBRN capabilities, and friendly vulnerabilities.

## THREAT ASSESSMENT

1-10. The potential for U.S. forces to encounter a CBRN incident in the OE remains a serious challenge. This threat can come from nation states and nonstate actors alike, sometimes simultaneously, and may occur in a variety of forms. These include deliberate attacks or accidental releases.

## **OPERATIONAL ENVIRONMENT ASSESSMENT**

1-11. The OE includes system variables and mission variables, PMESII, and to these variables USA doctrine adds two more: physical environment and time (PMESII-PT). Each set is useful to the Services at different echelons of command. These variables affect the manner in which multi-Service forces combine, sequence, and conduct military operations. Commanders tailor forces, employ diverse capabilities, and support different missions to succeed in this complex OE. (For a more in-depth discussion of the OE variables, see Field Manual [FM] 3-0.)

## **CAPABILITY ASSESSMENT**

1-12. Capability assessment is a process used to help identify and control resources and determine when and where to employ various CBRN capabilities across the full spectrum of missions, functions, operations, and activities.

## **VULNERABILITY ASSESSMENT**

1-13. Vulnerabilities are characteristics of an installation, unit, activity, port, ship, residence, facility, or other site requiring consideration for improvement to withstand, mitigate, or deter against CBRN threats and hazards. When improvements are not made, a risk-based approach to defense and protection activities must be undertaken. The primary focus is to identify threats and hazards critical to the success of the mission. (See chapter 2 for CBRN assessment activities.)

1-14. Planning is based on initial CBRN assessments and enables the commander and battle staff to identify minimum standards for training, organizing, equipping, and protecting resources. (See chapter 3 for CBRN planning activities.) Collaborative planning for CBRN actions ensures the preparedness and readiness of forces, adequate CBRN force allocation, and timely response and mitigation. The plan drives preparation and facilitates CBRN defense operations. Collaborative planning includes—

- Ensuring that planners and staffs have access to planning tools, data repositories, and automated resources necessary to perform planning functions.
- Planning for far-term contingencies, future and current operations, exercises, and training.

1-15. Preparation implements the approved plan and relevant agreements to increase readiness through training, exercises, and certification. The initiation of the CBRN intelligence, surveillance, and reconnaissance (ISR) plan is a key preparation activity to support the commander's critical information requirements (CCIR). Other key activities include implementing vulnerability reduction measures, conducting necessary movement, and conducting rehearsals. Interoperability is a key component of the integration and connectivity of preparation activities and includes ensuring access to or availability of the appropriate CBRN-related information technology. (See chapter 4 for CBRN preparation activities.)

1-16. CBRN execution activities should focus the commander and battle staff on continued CCIR and allow the collection of relevant information and intelligence to support decisions. (See chapter 5 for CBRN execution activities.) Decision support systems used must be interoperable, flexible, responsive, mobile, disciplined, survivable, and sustainable. CBRN execution activities may include CBRN—

- Active and passive protection (incident prevention).
- Incident response.
- Hazard prediction, modeling, warning, and reporting.
- Incident mitigation.
- Resource allocation, to include—
  - Reconnaissance.
  - Surveillance.
  - Protection.
  - Decontamination.
  - Casualty processing.

1-17. Commanders and CBRN staffs contribute to C2 through CBRN information systems. The CBRN shape function is representative of the CBRN aspects of C2 for all echelons among the Services.

1-18. Commanders and CBRN staffs synchronize the CBRN assessment activities—threat, operational environment, capabilities, and vulnerabilities—through the CBRN operations process. The key activities of the CBRN operations process, as shown in figure 1-2, page 1-4, are—

- Continuous assessment.
- Planning.
- Preparation.
- Execution.

## Chapter 2

# Chemical, Biological, Radiological, and Nuclear Assessment Activities

This chapter addresses key CBRN assessment activities that commanders use to measure warfighter progress toward mission accomplishment and compare the results to their initial vision and commander's intent.

## FUNCTIONS

2-1. CBRN C2 functions have a defined set of passive defense capabilities—CBRN shape, CBRN sense, CBRN shield, and CBRN sustain—that frame the discussion, assessment, and management of CBRN defense operations. Their definitions are as follows:

- **CBRN shape.** The ability to—
  - Characterize the CBRN hazard to the force commander.
  - Develop a clear understanding of the current and predicted CBRN situation.
  - Collect and assimilate information from sensors, intelligence, health, and surveillance in near real time to inform personnel.
  - Provide actual and potential impacts of CBRN threats and hazards.
  - Envision critical CBRN sense, CBRN shield, and CBRN sustain end states (preparation for operations).
  - Visualize the sequence of events that moves the force from its current state to those end states.
- **CBRN sense.** The capability to continually provide information about the CBRN situation at a time and place by detecting, identifying, and quantifying CBRN hazards in air, in water, and on land, personnel, equipment, and facilities. This capability includes detecting, identifying, and quantifying those CBRN hazards in all physical states (solid, liquid, and gas).
- **CBRN shield.** The capability to shield the force from harm caused by CBRN hazards by preventing or reducing individual and collective exposures, applying prophylaxes to prevent or mitigate negative physiological effects, and protecting critical equipment.
- **CBRN sustain.** The ability to conduct decontamination and medical actions that enable the quick restoration of combat power, maintain/recover essential functions that are free from the effects of CBRN hazards, and facilitate the return to preincident operational capability as soon as possible.

2-2. CBRN assessment, as a shape capability, is the continuous monitoring and evaluation of the current situation and the progress of an operation. CBRN assessments involve deliberately comparing actual events to forecasted outcomes to determine the overall effectiveness of force employment. Commanders and staffs monitor the situation and evaluate operation progress to determine if the current order is still valid or if there are better ways to achieve the end state. Assessments form the foundation of staff running estimates and assist commanders in maintaining an accurate situational understanding of their specific area of operations (AO) and revising their visualization as needed. The key assessments are—

- Threat assessment (intelligence preparation of the operational environment [IPOE] and intelligence preparation of the battlefield [IPB]).
- OE assessment (PMESII-PT/PMESII and METT-TC/METT-T).
- Capability assessment (personnel, units, equipment, networks, and logistics).
- Vulnerability assessment (analysis and reduction).

## THREAT

2-3. When designing operations, commanders and staffs analyze the CBRN threat to gain an in-depth understanding that considers more than just enemy military capabilities, order of battle, and tactics. CBRN threats and hazards can range from adversarial actions to man-made incidents or accidents to natural disasters. Target accessibility and vulnerability are additional variables in terms of the adversary's perceived net payoff and assessment of target opportunities and outcomes. During threat assessment, the CBRN staff assesses the enemy—

- Type and composition (CBRN-capable units) in the AO and area of interest (AOI).
- Disposition (C2 posts and threat training status).
- Capabilities (ranges and effectiveness of CBRN delivery systems, types of CBRN weapons available, and CBRN protective and detection equipment available).
- Intent (national policy and CBRN employment doctrine).

---

*Note.* This assessment will estimate how threat forces prefer to conduct operations under ideal conditions. A nuclear-capable threat may base employment on the weapon type, yield, and delivery systems available. How the enemy employs biological weapons will also depend on similar factors—usually, the type of agent and delivery system available. Enemy chemical employment can also be identified by the type of agent and delivery system. However, the use of chemical, nuclear, or radiological weapons could also be classified into three groups: terrain-oriented, force-oriented, or a combination of the two. (A terrain-oriented threat will attempt to use these agents to restrict terrain or shape the OE, and a force-oriented threat directly targets personnel concentrations. Biological agents would likely be used against personnel.)

---

2-4. The threat assessment should address the types of agents and hazards within an area of responsibility (AOR). Additionally, the unit should expect to receive information on potential storage or production facilities in the vicinity and methods that could be used to deliver CBRN agents or materials. Estimates may also be furnished on when, where, and how agents or materials may be used. Based on that type of input, the unit can consider relevant factors (terrain, weather). Higher headquarters guidance may also provide information on previous incidents and the current threat level as established in the AOR. Threat assessments are required if a deliberate adversarial capability, opportunity, or intent exist.

## ADVERSARIAL CAPABILITY

2-5. An adversary's capability to carry out a specific type of threat activity is assessed based on their capability to design, develop, or deliver the resources (weapon systems) used in that activity. Assessment information can come from intelligence sources on CBRN threats and hazards within the AOI. For example, a vast array of TIM facilities may exist in the AO or near the AO. Further, assessment of an adversary capability involves several factors that require more specifics and may generate an intelligence collection plan. Risk is measured when conducting assessments of the possibility of third-power intervention with CBRN weapons on the behalf of an adversary or the weaponization of a CBR agent or material, which could occur on a very rudimentary basis with an improvised dissemination device (handheld spray devices).

## ADVERSARIAL OPPORTUNITY

2-6. An adversary's opportunity to carry out an attack is assessed against particular targets and the type of weapons or systems required for effective use against a target. Planners consider the weather, terrain, installation boundaries, defensive posture, and other factors to assess when or where an adversary may attack. An assessment of how an adversary will attack considers the objective and means of delivery. An adversary may attack using overt or covert systems against operational-level targets:

- Overt systems include aircraft, cruise missiles, unmanned aircraft systems/remotely piloted vehicles, tactical ballistic missiles, and small boats.
- Covert releases include various aerosol-releasing devices, contamination of drinking water, and improvised CBRN devices.

## **ADVERSARIAL INTENT**

2-7. An adversary's goals, purpose, or aims, including the decisions required and means to achieve those goals, are assessed in terms of desired targets and effects. Planners conduct an assessment of adversary intent to use CBRN weapons or TIM. Adversary intent may be to cause casualties, contamination, degradation, or panic or to demonstrate its ability to attack anywhere at any time.

2-8. Thorough threat assessments allow commanders to tailor their CBRN intelligence capabilities to fit mission requirements. Success in these operations requires multidisciplined, all-source, fused intelligence because a single-source approach cannot support all CBRN intelligence requirements. Thorough mission analysis allows commanders to tailor their CBRN intelligence capabilities to fit mission requirements. Commanders adapt tactically to select the intelligence capabilities needed. They often use human intelligence and counterintelligence.

2-9. In each phase of the intelligence process, CBRN considerations must be handled in ways that do not fit neatly into the patterns used for other forms of intelligence support. The tactical employment of military forces examines the arrangement of the forces and efforts in time, space, and purpose (prioritizing the deployment of resources and ensuring the presence of a required infrastructure). Based on the IPOE/IPB, the CBRN staffs anticipate what may occur within the AO and conduct coordination, as required.

2-10. IPOE/IPB is a key tool for assessing the enemy situation, physical environment, and civil considerations. It begins during planning and continues during operations process activities. The continuous IPOE/IPB process must account for confirmed and plausible, adversary capabilities, plans, and actions. Adversary CBRN capabilities may result from research and development or the acquisition of readily usable CBRN capabilities from other countries or nonstate actors. Commanders must take into account these potential adversaries' CBRN capabilities in assessments, estimates, and plans.

2-11. The IPOE/IPB process must address the capabilities and limitations of adversary CBRN weapons and delivery systems; their command, control, and release procedures; the indicators of intent to employ CBRN weapons; and the possibility of direct or accidental release of TIM. IPOE/IPB remains the same for all types of military operations; however, its focus may change depending on the predominant type of operation or primary unit focus. Products required to portray the information may also change based on the type of operation. For example, threat and situation templates used to portray conventional threats differ from those used to portray asymmetric threats. In addition, civil considerations have assumed an importance on a par with the enemy and other conditions of the OE for all types of operations. IPOE/IPB products must provide enough detail for commanders and staffs to make informed decisions.

2-12. The intelligence staff officer's IPOE/IPB should focus on more than military capabilities and include information and analysis of OE variables. IPOE/IPB is designed to reduce the commander's uncertainties concerning weather, enemy, and terrain for a specific geographic area. It analyzes the intelligence database in detail to determine the impact of enemy, weather, and terrain on the operation and presents this information in graphic format. The IPOE/IPB enables the commander to see the battlefield—where friendly and enemy forces can move, shoot, and communicate; where critical areas lie; and where enemy forces (and his/her own) are most vulnerable. IPOE/IPB guides the intelligence staff officer (S-2) in determining where and when to employ collection assets to detect or deny enemy activities. These assets, working collectively, fulfill intelligence requirements and answer the priority intelligence requirements. IPOE/IPB is the key for preparing for battle. It is a continuous process that supports planning and execution for operations.

## **OPERATIONAL ENVIRONMENT**

2-13. Command staffs strive to provide a perspective of the interrelated variables that make up their specific OE. An OE is a composite of the conditions, circumstances, and influences that affect the employment of capabilities and bear on the decisions of the commander. A thorough assessment of the OE includes a detailed analysis of the various CBRN threats and hazards. However, for purposes of this publication, the threat assessment is addressed separately due to its complex nature and criticality to the CBRN operations process.

2-14. CBRN threats and hazards consist of complex, evolving, and adaptive systems that extend beyond the domain of historical operations. Joint doctrine defines a system as a functionally, physically, and/or behaviorally related group of regularly interacting or interdependent elements—that group of elements forming a unified whole. While Service forces may not adopt the joint systems analysis of the OE, commanders and staffs must understand this aspect of joint doctrine when participating in joint operation planning or assessment.

2-15. Commander estimates, staff estimates, and collaborative information sharing help commanders continue to refine and deepen their situational understanding of the OE. Estimates may require a constant reexamination of the OE that adopts a broader perspective of the situation, problems, and local challenges within the unit AO. In multi-Service doctrine, major variables that commanders and staffs at all levels should consider using for estimating and analyzing OE information are PMESII/PMESII-PT. During mission analysis at the tactical level, commanders and staffs can draw most of the relevant information needed for mission analysis from the more comprehensive PMESII/PMESII-PT analysis of their OE, using the factors of METT-TC (USA) or METT-T (USMC).

2-16. Commanders and staffs continuously analyze their OE and the progress of operations, comparing them to the commander's initial vision and intent. Understanding these variables, their interaction with each other, and how relationships among the variables change over time helps commanders and staffs realize how the effects of CBRN threats and hazards on one or more variables can affect their OE. Assessing the specific OE consists of—

- Monitoring the current situation and the progress of operations.
- Evaluating the operation against criteria for success.

## **CAPABILITY**

2-17. Commanders conduct the CBRN capability assessment continuously during the operations cycle in determining how to employ forces and equipment in a CBRN environment. The capability assessment is a comparison of current unit CBRN abilities, to include the proficiency of individual CBRN staff officers, command posts, cells, and elements, with the proficiency and resources required to support the commander during full spectrum operations. It involves the continuous assessment of unit plans, organization, manpower, equipment, logistics, training, leadership, infrastructure, and facilities, and readiness.

2-18. The following list provides a representative sampling of various CBRN-related capabilities that require continuous assessment:

- CBRN units.
- CBRN staffs.
- CBRN equipment.
- CBRN reconnaissance and surveillance (*Multiservice Tactics, Techniques, and Procedures for Nuclear, Biological, and Chemical Reconnaissance*).
- Collective protection (*Multiservice Tactics, Techniques, and Procedures for Nuclear, Biological, and Chemical [NBC] Protection*).
- Decontamination.
- Automated warning and reporting (JWARN).
- Hazard prediction and modeling (JWARN/Joint effects model [JEM]).
- Preventive medicine (FM 4-02.7).
- Casualty management (FM 4-02.7).
- Laboratories (FM 4-02.7).
- Technical escort (FM 3-11.20).
- Incident/hazard risks.



## VULNERABILITY ASSESSMENT

2-19. CBRN vulnerability assessments are essential to force protection (FP) planning. They provide the commander a tool to determine the potential vulnerability of an installation, unit, activity, port, ship, residence, facility, or other site against CBRN threats and hazards. The CBRN vulnerability assessment identifies functions or activities that are vulnerable to threats and require attention from C2 authorities to address improvement to withstand, mitigate, or deter against the threat. When improvements cannot be made, a risk-based approach to defense and protection activities must be undertaken.

2-20. The CBRN vulnerability assessment compiles the other types of assessments discussed into an overall snapshot of unit ability to support or conduct an operation given the specific OE and unit capabilities. (See figure 2-1 for an illustration of the vulnerability assessment process.)



**Figure 2-1. Vulnerability assessment process**

2-21. The CBRN vulnerability assessment will—

- Indicate what the vulnerabilities are.
- Determine the likelihood that CBRN threats or hazards will exploit a given vulnerability based on knowledge, technologies, resources, probability of detection, and payoff.
- Predict the potential impact to the AO if the vulnerability is exploited.

2-22. CBRN vulnerability assessments require a comparison of the threat with unit vulnerabilities to determine the efforts necessary to safely meet incident requirements. A vulnerability assessment also includes the integration of the commander's guidance through a risk management process to prioritize the implementation of vulnerability reduction measures.

2-23. Given the factors in the risk equation and the cost of implementing countermeasures, a determination may be made that the risk potential of a given vulnerability is not worth the cost of correcting or implementing a CBRN defensive countermeasure. (See appendix B for CBRN vulnerability assessments.)



**This page intentionally left blank.**

## Chapter 3

# Chemical, Biological, Radiological, and Nuclear Planning Activities

Planning is the process by which commanders (and staff, if available) translate the commander's visualization into a specific course of action (COA) for preparation and execution, focusing on the expected results. Planning begins with the analysis and assessment of the situation to comprehend the relationship of the factors of METT-TC/METT-T. It involves understanding and framing the problem and envisioning the set of conditions that represent the desired end state. Based on the commander's guidance, planning includes formulating one or more supportable COAs to accomplish the mission. The basic planning process for CBRN operations remains the same across the full spectrum of military operations and should ensure the integration of CBRN considerations into the decisionmaking processes. At the tactical level, CBRN planning takes plans and estimates at the strategic and operational levels into account. One of the key facets of plans for CBRN operations, given the large variety of potential agents and weapons, is to limit the agents and weapons under consideration to those most likely to be employed during the time period being addressed. Planning must—

- Involve a detailed, systematic analysis to produce an optimal COA; or conversely, planning may be a rapid process that reaches an acceptable COA quickly by considering only critical aspects of the problem.
- Facilitate establishing or maintaining the tempo that the commander desires.
- Help to ensure the proper placement of CBRN assets in-theater before a crisis or conflict and in the time-phased force and deployment sequence prepared to support movement to the theater. In particular, the commander should be cognizant of significant shortfalls in the capability or availability of CBRN assets.
- Focus on ensuring that commanders can accomplish their mission-essential tasks in CBRN environments.

## PLANNING PROCESSES

3-1. The commander, CBRN staff officer, unit leader, or section leader must provide specific CBRN threat and hazard information during a deliberate planning process. The purpose of this guidance is not to replace Service guidance, but to highlight some CBRN-related considerations of the planning process that apply to staffs, units, and sections during operations.

3-2. Planning is a process that integrates the activities of the commander, staff, and subordinate commanders in developing a series of products that are needed to execute the CBRN operation. These products include updated staff estimates, intelligence products, and control measures. The application of planning processes matures CBRN vulnerability assessments and casualty estimates into decision briefings and published CBRN action plans.

3-3. The planning process establishes appropriate command, planning, and operational relationships and ensures that vulnerabilities do not compromise U.S. forces or missions. Whether done at the strategic, operational, or tactical level, the key functions of planning are to—

- Direct and coordinate active and passive CBRN actions.
- Develop a shared SA of the AO.

- Generate common expectations about how action evolves and how it will affect the desired outcome.
- Support the exercise of initiative.
- Shape the thinking of planners.
- Identify, assess, and estimate adversary CBRN capabilities, intentions, and most likely COAs based on the situation.
- Provide recommendations for the commander’s planning guidance to help ensure that forces and facilities are prepared to operate in CBRN environments.

3-4. CBRN planning involves conducting assessments of the OE, CBRN threats and hazards, CBRN vulnerabilities, CBRN capabilities, and risk. Additionally, the IPOE/IPB, targeting, and ISR processes are integrated into the decisionmaking process. The unit uses the method its Service normally uses to plan missions. Two of these methods are the MDMP and the MCPP. (See figure 3-1 for a comparative depiction of the planning processes.)

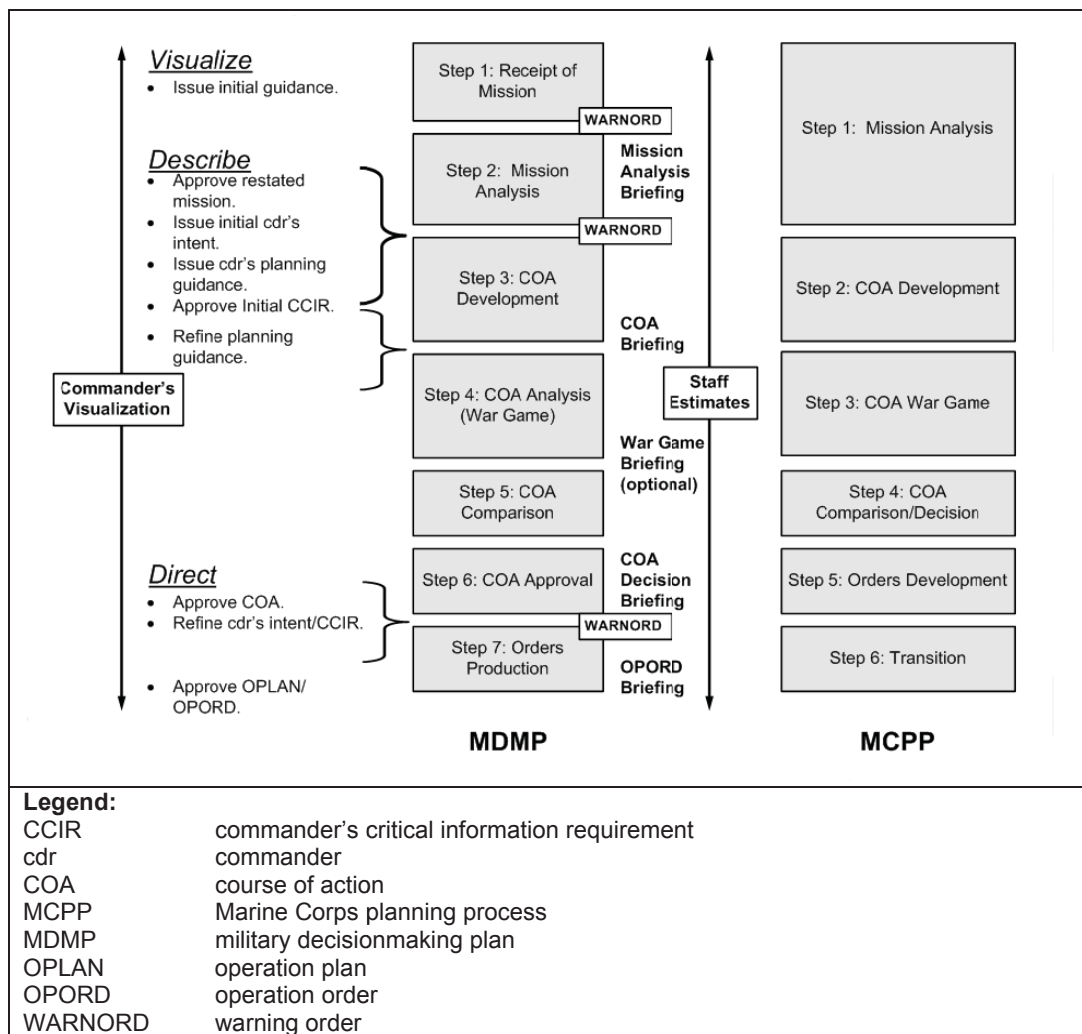

Figure 3-1. Comparison of the MDMP and MCPP

3-5. Planning CBRN and support actions are integral components of full spectrum operations. Commanders direct operations and synchronize the warfighting functions through plans and orders. Planners should always—

- Focus on the threat.
- Identify the phases or steps required to achieve the vision.

- Assign objectives and CBRN vulnerability reduction measures to each phase.
- Identify the main and supporting CBRN vulnerability reduction measures in each phase.
- Assign resource priorities in each phase.
- Identify indicators of success to monitor the progress of the commander's planning guidance.
- Assess the readiness to respond to CBRN events.

3-6. Commanders must provide sufficient planning guidance for their staffs to develop estimates and feasible COAs as they relate to and support CBRN operations. To make the guidance more meaningful, the commander should also provide his/her vision of the operation to the staff. The following elements must be included:

- Threat COAs.
- Friendly COAs.
- Restated mission.
- Commander's intent.
- Deception objective.
- Priorities.
- Time plan (produced from the analyses of available time conducted by the commander and staff).
- Type of order to issue.
- Type of rehearsal to conduct.

3-7. Regardless of the amount of commander's guidance provided, the CBRN staff must be prepared to receive and retain the details. A common mistake made by commanders is assuming that the CBRN staff understands their planning guidance when, in fact, they do not.

3-8. The commander's planning guidance should consider the entire AO, and it should address ways to enhance the protection of friendly forces and maximize combat power. (See appendix C for planning process considerations as they relate to CBRN operations.)

## **ASSESSMENT ACTIVITIES**

3-9. CBRN planning support to decisionmaking is dynamic and continuous. However, it must also be preplanned in the sense that extensive CBRN threat, OE, capability, and vulnerability assessments must be completed early enough to be factored into the commander's decisionmaking effort. The goal of the assessment process is to achieve the level of protection sought through the implementation of mitigation measures. (See appendix D for threat assessment checklists.)

3-10. During the planning phase of the operations process, the CBRN threat or hazard is identified, defined, and quantified to provide information for ISR planning and potential target nominations. The CBRN staff should gather information about adversary capabilities, opportunities, and intent and begin coordination with the intelligence section to—

- Identify CBRN-related intelligence gaps and initiate actions to fill them (use the previously developed knowledge base and begin new intelligence collection operations).
- Determine CBRN-related gaps in the priority intelligence requirements, and add them to the collection plan.
- Update threat models with the CBRN-related data that has been collected.
- Convert threat doctrine into a doctrinal template.
- Describe the threat CBRN-related tactics and options.
- Identify high-value targets that may be targeted by CBRN weapons.
- Identify threat CBRN capabilities.

3-11. IPOE/IPB provides a systematic, continuous process for analyzing the threat and other conditions of the OE, which include terrain, weather, and civil considerations. IPOE/IPB supports the commander's visualization, staff estimates, and the planning process. It takes a well-trained staff to successfully perform IPOE/IPB. During the planning phase, IPOE/IPB—

- Defines the OE.
- Describes the OE effects.
- Produces an evaluation of the threat.
- Develops possible enemy COAs.

3-12. An OE assessment provides the unit commander with information on the major CBRN systems, friendly and adversary CBRN capabilities, vulnerabilities, threats, and physical characteristics and the political environment. The CBRN staff addresses the effects of weather and terrain on CBRN operations in the AO/AOI (soil type, surface drainage, vegetation type and distribution, precipitation, wind patterns, temperature, humidity, cloud cover, topography). These variables affect agent and radiation persistency and effectiveness and the extent of possible contamination areas. The CBRN staff must also consider these variables for hazard prediction and reduction measures (decontamination). Most of this information can be determined through a map analysis supplemented by reconnaissance (chemical, aerial, military intelligence, or scout assets), a chemical downwind message, effective downwind message, and supporting weather elements.

3-13. During the planning phase, the consideration of operational variables can lead to the identification of key CBRN-related nodes, links, and vulnerabilities. When the adversary is a state actor, the variables will be present, with many of them possessing tangible infrastructure that is easily identified by ISR. When the adversary is a nonstate actor, these same variables will be present to varying degrees. Nonstate actors are organized in a fundamentally different way than states actor, and they manifest themselves in completely different ways. However, the PMESII/PMESII-PT framework for analysis applies to OEs involving state actors, nonstate actors, or both. (See appendix E for CBRN considerations as they relate to PMESII/PMESII-PT.)

3-14. Drawing from the variables of PMESII/PMESII-PT, the factors of METT-TC/METT-T serve as a standard format for the identification of CBRN threats and hazards at the tactical level. The variables of METT-TC are used because they are institutionalized in the USA through its professional military education and initial-entry training systems. The USMC and joint doctrine use the term METT-T; civil considerations are inherently measured within the context of this acronym. METT-TC/METT-T is primarily used as part of the USA MDMP and USMC MCPP for tactical missions. However, the same thought process is equally effective when considering nontactical operations and the off-duty environment. (See appendix E for CBRN considerations as they relate to the factors of METT-TC and METT-T.)

3-15. Friendly force organizations, manpower, equipment, logistics, training, leadership, infrastructure, facilities, and readiness are continuously monitored and updated based on the CBRN threat and OE assessments. During the planning phase, the commander and CBRN staff consider the following:

- Equipment adequacy and the training of nonmilitary and non-U.S. logistics personnel to survive and operate in an environment containing CBRN threats and hazards.
- Whether forces and facilities are prepared to operate in CBRN environments, taking due account of the civilian population and key host nation (HN) AOIs.
- CONOPS and procedures associated with operating on fixed installations (aerial ports of debarkation [APODs], seaports of debarkation [SPODs]).
- Whether critical logistics throughput and transportation facilities receive adequate protection.
- Whether plans, training, and equipment are in place for the rapid restoration of operations after an attack.
- Coordination actions to ensure that adequately integrated relationships are established between separate organizations located in the same area.

---

*Note.* See appendix C for planning processes.

---

3-16. The commander establishes and implements a deliberate process for assessing the vulnerability of manpower, facilities, and materiel to a CBRN attack. This process will integrate offensive and defensive capabilities to reduce the threat of CBRN use and sustain operations if attacks occur. The process will also include executing mitigation and restoration plans to reduce the operational impact of CBRN contamination.

3-17. Assessment tasks take different forms during planning, preparation, and execution. During planning, assessments allow commanders and CBRN staffs to establish initial criteria for evaluating success, assess the situation in terms of expectations developed during the COA analysis, and evaluate the progress of the plan throughout the operations cycle. Throughout the process, IPOE/IPB and continuous updates are key tools for assessing the enemy situation and the AO. This means that assessment measures and collection means have to be understood. (See table 3-1 for more information on operations process assessment tasks.)

**Table 3-1. Operations process assessment tasks**

<i>Plan</i>	<i>Prepare</i>	<i>Execute</i>
<ul style="list-style-type: none"> <li>• TLP and MDMP</li> <li>• Orders and plans</li> </ul>	<ul style="list-style-type: none"> <li>• Reconnaissance</li> <li>• Security</li> <li>• FP</li> <li>• Revision and refinement of plan</li> <li>• Coordination and liaison</li> <li>• Rehearsals</li> <li>• Task organization</li> <li>• Training</li> <li>• Movement</li> <li>• Precombat checks and inspections</li> <li>• Logistics preparations</li> <li>• Integration of new Soldiers and units</li> </ul>	<ul style="list-style-type: none"> <li>• Decide                             <ul style="list-style-type: none"> <li>▪ Execution</li> <li>▪ Adjustment</li> </ul> </li> <li>• Direct                             <ul style="list-style-type: none"> <li>▪ Apply combat power</li> <li>▪ Synchronize</li> <li>▪ Maintain continuity</li> </ul> </li> </ul>
<i>Assessment</i>		
<ul style="list-style-type: none"> <li>• Monitor the situation.</li> <li>• Monitor criteria of success.</li> <li>• Evaluate COAs.</li> </ul>	<ul style="list-style-type: none"> <li>• Monitor preparations.</li> <li>• Evaluate preparations.</li> </ul>	<ul style="list-style-type: none"> <li>• Monitor operations.</li> <li>• Evaluate progress.</li> </ul>
<i>Continuous Assessment</i>		
<ul style="list-style-type: none"> <li>• Situational understanding (sources, solutions)</li> <li>• Monitoring (situation, operations, criteria of success)</li> <li>• Evaluating (forecasting, seizing, retaining, and exploiting the initiative; variances)</li> </ul>		
<b>Legend:</b> COA            course of action FP             force protection MDMP        military decisionmaking process TLP            troop-leading procedure		

3-18. Unit staff and CBRN personnel work together to ensure that analyses are fully integrated into deliberate and crisis action planning. They accomplish this by war-gaming friendly versus adversary COAs and jointly developing products designed to assist Service components and multinational partners and facilitate the decisionmaking processes.

## **AUTOMATED PLANNING TOOLS**

3-19. Automated planning tools use tactical unit level and installation resources to obtain and assess environmental background data (including climatology) for potential CBRN implications. These capabilities facilitate warning and alarming personnel potentially affected by the CBRN threats and hazards in time to assume protective posture. (See appendix F for automated planning tools.)

3-20. The warfighter needs planning and early warning intelligence for tactical planning and response to incoming threats. JWARN and JEM (which is an emerging capability to begin fielding in fiscal year 2009), when used as planning capabilities, provide commanders and their CBRN staff with preincident and predictive modeling.

3-21. JWARN will reside in C2 centers at the echelon levels defined by the Services and enable CBRN defense specialists and other designated personnel to update the COP with CBRN-related information. JWARN operators will develop likely CBRN attack scenarios reflecting the capabilities of adversary forces. Analyzing these scenarios in JWARN as part of current operation (near-term) planning will allow the JWARN operator to recommend the positioning of CBRN sensors, pre-positioning of CBRN equipment and consumables, and modification of JEM templates so that high-fidelity hazard predictions better reflect the potential capabilities of adversary forces.

3-22. Information from the JWARN analysis of likely CBRN scenarios will support decisionmaking at the tactical level of warfare by increasing the timeliness and accuracy of CBRN warning and reporting. Increased SA will allow the commander to identify and warn units at risk, identify where CBRN units and equipment should move, deploy CBRN reconnaissance teams, and provide CBRN route information to friendly forces. (See appendix F for Service-specific CONOPS for JWARN.)

## **INTELLIGENCE, SURVEILLANCE, AND RECONNAISSANCE PLANNING**

3-23. ISR is an integral part of the warfighting mission. The commander and staff deploy reconnaissance assets early in the planning process to facilitate early collection. The information collected is analyzed and incorporated into the planning process. The ISR plan is not a military intelligence specific product and is often the most important source for information and intelligence that contributes to answering CBRN-specific CCIRs.

3-24. The ISR plan is the fusion point for synchronizing intelligence collection to produce information requirements related to the AO and CBRN threats and hazards. Making the most effective use of available information and collection assets requires managing these requirements. The intelligence synchronization process ensures that the CBRN staff section or collection asset is tasked to collect the required information. It also ensures that the optimal collector is tasked and the highest priorities are satisfied first.

3-25. Commanders integrate CBRN reconnaissance missions and surveillance means to contribute to an integrated ISR plan that capitalizes on their different capabilities. Reconnaissance is often the most important part of this activity, providing data that contributes to answering the CCIRs. As such, commanders conduct it with the same care as any other operation. They normally initiate reconnaissance operations before completing the plan. In fact, information on which the final plan is based is often gathered during reconnaissance operations.

3-26. It is critical that the reconnaissance unit leaders ensure that available assets are integrated into the reconnaissance and surveillance plan. In addition, they must ensure that the reconnaissance plan is synchronized with their sustainment, communications, and medical evacuation plans.

3-27. The quality of available information and intelligence significantly influences the ability to produce a viable CBRN action plan. The more intelligence available, the better the commander and staff can plan. Less information means that the commander has a greater chance of making a poor decision. (See *Multiservice Tactics, Techniques, and Procedures for Nuclear, Biological, and Chemical Reconnaissance*.)

## **TARGETING PROCESS**

3-28. The targeting process has CBRN implications when units conduct deliberate target assessments as part of IPOE/IPB and prepare “target folders” for each site assessed. Pertinent information collected by the units for each target is maintained in the target folder for use in a future response. Information could include floor plans, site maps, routes in and out, potential staging areas, and a determination of prevailing winds to produce downwind hazard predictions. Commanders and CBRN staffs use these target folders to facilitate the development of response plans and CBRN vulnerability reduction measures and war-game



how they would respond if a WMD-sensitive site was discovered or if a CBRN-related incident occurred. (See table 3-2 for suggested target folder content [there is no standard format for these folders].)

**Table 3-2. Sample target folder content**

<i>Target Folder</i>	
Threat overview	Site description
Site overview	Site significance
Site history	Environmental hazards as a result of accidental release
CBRN agent presence	Terrain
Simulation analysis	Collection strategies
Agent data	Additional site exploitation
Background information	Command guidance
Graphics	Transportation
Drawings	Roads
Maps	Analyst comments
Photos	Projects and agents
Building plans	

3-29. According to JP 1-02, a target is an entity or object considered for possible engagement or other action. Targets also include the wide array of mobile and stationary forces, equipment, capabilities, and functions that an enemy commander can use to conduct operations. Target development, also called *targeting*, is the process of selecting targets and matching the appropriate response to them on the basis of operational requirements, capabilities, and limitations.

3-30. The targeting process supports offensive operations and WMD elimination mission sets for combating WMD—the emphasis of targeting is to identify resources (targets) that the enemy can least afford to lose or that provide the greatest advantage and then identify the subset of those targets that must be acquired and attacked to achieve friendly success. Denying these resources to the enemy makes him/her vulnerable to friendly battle plans. These resources constitute critical enemy vulnerabilities. Successful targeting enables the commander to synchronize intelligence, maneuver, fire support systems, and special operations forces by attacking the right target with the best system and munitions at the right time.

3-31. Targeting is an integral part of the planning and decisionmaking processes. The operational-level commander relies on his/her tactical-level commanders to effectively orchestrate the targeting process. The operational commander best influences the outcome of future tactical battles by setting the conditions for those battles and allocating resources to Service components. The targeting process is accomplished by the components applying Service-developed TTP within a joint framework established by the commander.

## HEALTH SERVICE SUPPORT

3-32. The medical planner is responsible for planning and coordinating HSS. The complexity of medical planning and execution requires full-time attention from a qualified medical planner. Medical considerations can adversely affect operational and tactical operations because of unique mission requirements and the environment that CBRN threats and hazards create. Nonmedical staffs cannot provide the commander with the same support as a dedicated medical planner. (See Department of Defense Instruction (DODI) 6200.03 for details on the assignment of public health emergency officers for DOD installations.)

3-33. The medical planner should understand the capabilities and limitations of the medical assets when planning HSS throughout the AO. Without collective protection, medical assets will be unable to treat casualties in chemically contaminated environments and may suffer operational degradation in radiological or biological environments.



3-34. When a CBRN attack occurs on or near the AOR, the medical planner must be prepared to quickly and efficiently transition from planning for conventional casualty operations to conducting contaminated casualty operations. For this information to be obtained quickly, a medical planner must be located in the unit tactical operations center. He/she must monitor the unit internal command radio net and/or the administration/logistics radio net.

3-35. Successful CBRN attacks may produce mass casualty events. When medical CONOPS are developed, planners must consider the risk of CBRN threats and hazards and the increased burden on medical infrastructure. The medical laydown and CONOPS for CBRN threats and hazards should be seamless and consistent with non-CBRN CONOPS to the extent possible. The same building block approach should be used, where medical CBRN-specific assets are laid over conventional medical assets. The flow of these assets into the theater must be driven by the mission needs of the joint force commander and relative health threats.

3-36. The joint tool approved for calculating medical requirements is the joint medical analysis tool. Currently, the joint medical analysis tool does not include the capability to generate medical requirements for CBRN casualties. However, the Defense Medical Standardization Board is developing task, time, and treater files for use with the joint medical analysis tool for various CBRN casualty profiles. These files can be used to determine Class VIII equipment and supply requirements. The Services are responsible for generating casualty estimates and tracking casualty rates for contingency operations.

## Chapter 4

# Chemical, Biological, Radiological, and Nuclear Preparation Activities

This chapter examines CBRN preparation measures and stresses the importance of key logistics, education, training, rehearsal, exercise, and HSS considerations. Preparation requires the steady infusion of new operational TTP, CONOPS, and standardized leadership protocols. CBRN preparation includes those activities undertaken by the unit before execution to improve its ability to conduct the operation. Preparation includes plan refinement, rehearsals, reconnaissance, coordination, inspections, and movement. When not executing CBRN operations, commanders prepare their forces for CBRN operations. These preparations include training and maintaining personnel and CBRN equipment. Preparation for a specific operation starts with the receipt of a warning order and ends when execution begins. CBRN staffs focus on monitoring and determining changes in friendly forces' CBRN readiness status and their ability to execute the operation. Preparation is an ongoing process that overlaps the planning and execution phases. Preparation is evaluated against the commander's criteria for success that is established during planning to determine variances and forecast the significance of those variances to mission success. Estimates begun during planning continue, enabling commanders and staff to understand the factors of METT-T and METT-TC in relation to each other and their impact on the end state. These estimates, usually drawing relevant information from a more comprehensive analysis of the specific OE using the PMESII/PMESII-PT variables, facilitate an accurate understanding of the OE and contribute to updating and refining the plan. New orders are issued to modify subordinates' mission tasks, if necessary, as commanders continue their visualization. During preparation, CBRN staffs continue to update and refine products developed during planning. IPOE/IPB focuses on providing an updated picture of the OE and the CBRN threats and hazards based on new information gathered through collection and friendly reporting. Staffs also ensure that these products are available and disseminated to subordinate units, which often do not have the resources available to higher headquarters. CBRN preparation consists of the following activities, which involve actions by commanders, staffs, units, and Service members:

- ISR operations.
- Assessments.
- Task organization.
- Movement.
- Coordination and liaison.
- Logistics.
- Education.
- Training.
- Rehearsals.
- Exercises.
- HSS.

## **INTELLIGENCE, SURVEILLANCE, AND RECONNAISSANCE OPERATIONS**

4-1. ISR operations commence simultaneously with other preparation activities so that the commander can improve situational understanding about an adversary and other conditions of the AO and apply vulnerability reduction measures before executing major operations. Commanders typically employ CBRN reconnaissance and surveillance capabilities in advance of other capabilities to provide warning and protect personnel, equipment, and other key assets from the adverse effects of CBRN hazards. CBRN reconnaissance and surveillance operations continue concurrently with other preparation and execution activities according to the collection plan.

4-2. CBRN reconnaissance and surveillance constitute intelligence collection efforts to answer CCIR and set the conditions to execute military operations while preventing adverse effects from CBRN hazards. Adverse effects are prevented by preventing the employment/release of CBRN material or avoiding contamination if a CBRN incident occurs. Contamination can be avoided by determining the extent of contamination and/or establishing a bypass route through the contaminated area. This collection effort supports commanders' decision points throughout an operation. Timely and accurate intelligence of CBRN threats and hazards encourages audacity and facilitates actions that may negate enemy superiority in personnel and materiel.

4-3. CBRN reconnaissance and surveillance are not static, single efforts that accomplish a task and stop. As reconnaissance forces collect information, the staff modifies the collection plan to account for new information and redirect ISR efforts. Commanders and staffs continuously review intelligence products and synchronize their CBRN reconnaissance and surveillance efforts within the overall ISR plan. They focus on the most critical vulnerabilities, emphasizing the established or revised CCIRs. Commanders balance the following factors against their need for relevant information:

- The ability of CBRN reconnaissance and surveillance capabilities to gather the information.
- The acceptable risk to these assets during the collection of information and samples.
- The ability to sustain the CBRN reconnaissance and surveillance effort over time.
- The requirement to have CBRN reconnaissance and surveillance assets available at critical times and places.

4-4. The result of the above is a continuous feed of relevant information that facilitates the commander's situational understanding and, ultimately, supports his/her key decision points for the overall operation.

## **THREAT ASSESSMENT**

4-5. During the preparation phase of the operations process, the CBRN threat or hazard is already identified, defined, and quantified. The threat includes those aggressors (people or groups) that are known to exist and have the capability and a history or expressed intention of using hostile actions against potential targets that are identified in the plan. The threat also includes aggressors who are, according to current credible intelligence information, conducting targeting activity (surveillance of potential targets) or preparing for intentional acts. The CBRN staff should evaluate whether adversary capabilities, opportunities, or intent have changed or remain the same. Checklists for continuously evaluating and updating threat assessments are key tools in the preparation phase. (See appendix D for threat assessment checklists.)

## **OPERATIONAL ENVIRONMENT ASSESSMENT**

4-6. An updated picture of the OE and CBRN threats and hazards is developed based on new information gathered through continuous collection and friendly reporting during IPOE/IPB. This ongoing assessment during the preparation phase helps refine and deepen the commander's situational understanding of the OE and the perspective of the situation, problems, and local challenges within the unit AO.

## **CAPABILITY ASSESSMENT**

4-7. The capabilities and histories of friendly force organizations, manpower, equipment, logistics, training, leadership, infrastructure, facilities, and readiness are continuously monitored and updated based on the CBRN threat and OE assessments. During the preparation or preexecution phase, precombat checks and inspections are conducted. (See appendix G for preparation checklists that provide force readiness information.)

## **VULNERABILITY ASSESSMENTS**

4-8. A vulnerability assessment evaluates the potential vulnerability of critical assets against a broad range of identified CBRN threats and hazards. The vulnerability assessment provides a basis for determining mitigation measures for the protection of critical assets. These measures may reduce risk by deterring, detecting, denying, or devaluing the potential threat element before or during the execution of an enemy attack. The vulnerability assessment is the bridge in the methodology between the CBRN threat and/or hazard, OE, and capability and the resultant level of risk. Based on the commander's risk-based guidance, vulnerability reduction and mitigation measures are implemented during the preparation phase. Vulnerability reduction measures occur as part of a commander's CBRN protection strategy, to include corresponding CBRN protection measures. Passive defense is the focus of the vulnerability reduction measures discussed in this chapter.

4-9. The highest priorities for passive defense are force survivability and successful mission accomplishment. Passive defense operations include measures to minimize or negate the vulnerability to, and minimize the effects of, CBRN use; this includes protecting assets, sustaining mission operations, and minimizing casualties. Passive defense vulnerability planning is supported by higher commands that provide available information on enemy capabilities and technical reachback capability. (See appendix H for technical reachback capabilities.)

4-10. Preattack vulnerability reduction actions are critical because they increase the unit survivability to the greatest possible extent. These actions include selecting the right and collective protection, fortifying shelters, establishing procedures for warning and reporting, and protecting vital equipment to increase survivability.

4-11. Additionally, whenever the tactical situation permits, units prepare defensive positions that vary from individual fighting positions to improved critical infrastructures at installations and fixed sites. These actions and prior planning protect against CBRN effects. The primary concern should be shielding personnel from CBRN threats and hazards. (See appendix E for vulnerability reduction measures.)

## **TASK ORGANIZATION**

4-12. The way that CBRN assets go to war is not always the way they execute operations. CBRN forces can be cross-attached or reorganized to meet mission requirements, and they are managed in a way that maintains the quality and overall health of our expeditionary force. CBRN forces are unique, flexible, and tailored for joint mission requirements—to provide defense support to civil authorities or to surge and conduct major combat operations when required. (See appendix I for USA capabilities and employment, appendix J for USAF, appendix K for USMC, and appendix L for USN.)

4-13. Task organizing is the act of designing an operating force, support staff, or logistics package of specific size and composition to meet a unique task or mission. Characteristics to examine when task-organizing the force include—but are not limited to—training, experience, equipment, sustainability, OE, enemy threat, and mobility. Today's OE of continuous operations renders the old paradigm of tiered readiness obsolete. Tiered readiness created "have" and "have-not" units by allocating resources according to unit placement in the deployment sequence for contingency war plans. Tiered readiness also cascaded equipment modernization by units. Commanders and staffs must align CBRN units against future missions as early as possible and task-organize modular expeditionary forces that are tailored to meet joint mission requirements.

4-14. Task organizing CBRN forces yields a significant number of advantages, which include—

- A steady-state supply of trained and ready warfighters with enablers.
- Stabilized personnel who train, deploy, and fight together in the same unit.
- Deployment planning goals to identify high-demand, low-density units.
- The opportunity to synchronize a broad range of force-generating processes.

## MOVEMENT

4-15. If necessary, the early movement of CBRN units, personnel, and equipment to support mission requirements will occur during the preparation phase.

4-16. Movement includes planning, routing, scheduling, and controlling personnel and materiel movements into, within, and out of an AO. Maintaining movement control, keeping lines of communication open, managing reception and transshipment points, and obtaining HN support are critical to CBRN operations.

4-17. The analysis of terrain and weather helps commanders and staffs find tactical advantages by analyzing and comparing the limitations of the physical environment on friendly, enemy, and neutral forces. Terrain includes operating surfaces and man-made features (cities, airfields, bridges, railroads, ports). The type of surface will be integral to determining the persistency, off-gassing, adsorbance, absorbance, and reactivity of agents and materials.

4-18. Weather and terrain also have pronounced effects on maneuver capabilities, precision munitions, air support, and CBRN operations. The nature of CBRN operations extends the analysis of the natural environment (weather and terrain) into the context of the physical environment of a contaminated AO. Terrain directly affects the selection of objectives and the location, movement, and control of forces.

4-19. CBRN staffs should coordinate with commanders of fixed installations (APODs, SPODs) and understand the CONOPS and procedures associated with operating on a fixed installation. (See *Multiservice Tactics, Techniques, and Procedures for Installation Chemical, Biological, Radiological, and Nuclear Defense* for more guidance.)

## COORDINATION AND LIAISON

4-20. The commander will publish the appropriate guidance required to establish CBRN defense roles and responsibilities for separate organizations/Services located in the same area.

4-21. Coordination is the action necessary to ensure that adequately integrated relationships are established between separate organizations located in the same area. (See *Operational Terms and Graphics* for more information.) The coordination of CBRN forces may include decontamination support, reconnaissance AORs, deconfliction of CONOPS and standing operating procedures (SOPs) in the same location with differing Services and nations (APOD/SPOD), obscuration measures, and area reconnaissance.

4-22. Coordination takes place continuously throughout operations. Commands do not operate in isolation; they synchronize their actions with those of others. Coordination is essential to this synchronization. The objectives of coordination include, but are not limited to—

- Ensuring a thorough understanding of the commander's intent and subordinate and supporting force roles.
- Ensuring that affected and interested personnel have been consulted or informed, as time allows, so that they may respond as desired or adjust their plans and actions.
- Ensuring that commanders and staffs consider as many relevant factors as time permits and effectively employ available assets.
- Ensuring appropriate liaison with affected and potentially supportive civilian HSS facilities and conducting an assessment of the capabilities and limitations of those facilities.
- Communicating with HSS for health services (medical surveillance).
- Avoiding conflict and the duplication of effort among units and reducing fratricide and resource expenditures.

## LOGISTICS

4-23. Pre-positioning, maintaining, and issuing CBRN defense equipment and supplies occur during preparation. Other possible logistics activities include identifying water supply points, identifying medical treatment facilities, ensuring the availability of system level contracted logistics support, and identifying resources available in the area and making arrangements to acquire them. Commanders direct operations security measures to conceal preparations and friendly intentions.

4-24. Medical treatment personnel and medical treatment facilities may have a limited stock of antidotes, immunizations, pretreatments, and other Class VIII supplies on hand. However, resupply must be readily available for continuous response to the incident. (See FM 4-02.1 and JP 4-02.)

## EDUCATION

4-25. Professional military education is comprised of progressive levels of military education that prepare military officers and NCOs for leadership. It includes various basic level courses for new and junior officers; command and staff colleges for mid-level officers; war colleges for senior officers; primary, basic, and advanced leadership courses for enlisted personnel and junior and senior staff level NCOs; and the sergeants major academy for senior NCOs.

4-26. Professional military education can develop much of the CBRN-specific knowledge and many of the specialized skills that commanders require. Developing leadership qualities and practicing leadership skills are necessary for subordinates to make effective decisions and act decisively during operations.

## TRAINING

4-27. CBRN-specific training is necessary to ensure that forces are prepared to accomplish assigned missions and manage CBRN threats and hazards in the OE. A CBRN training program will significantly reduce the overall vulnerability of a unit to CBRN threats and hazards and provide immediate payback to overall readiness by increasing awareness and reinforcing critical individual and collective skills. Areas that require training include the capability to—

- Designate proposed decontamination sites.
- Assess the CBRN threat, potential risk, and likelihood of attack; and accomplish vulnerability assessments.
- Implement coordinated CBRN plans.
- Prepare to provide care for casualties.
- Determine and implement the mission-oriented protective posture (MOPP) level.
- Minimize skin exposure.
- Continue good hygiene and sanitation practices.
- Deploy and activate detectors.
- Execute environmental sampling operations.
- Designate and prepare shelters.
- Watch for attack indicators.
- Cover or conceal unprotected, mission-essential equipment.
- Conduct meteorological monitoring.
- Integrate available alarm and chemical, biological, radiological, and nuclear warning and reporting systems (CBRNWRSs).
- Ensure that pretreatments, chemoprophylaxis, immunizations, insect repellents, and barrier creams are available and in use, as appropriate.
- Use collective protection.
- Use emergency response (fire and rescue, hazardous materials, and explosive ordnance disposal [EOD]) capabilities.
- Conduct medical surveillance.
- Establish baseline medical surveillance.



- Coordinate health risk assessments for the population at risk.
- Coordinate CBRN and medical capabilities.
- Establish procedures for tracking, raising, and lowering MOPP levels.
- Place and deploy active defense units.

4-28. Training provides the means to practice, develop, and validate—within constraints—the practical application of multi-Service doctrine. Equally important, it provides the only peacetime basis for the firsthand experience essential to commanders and staffs in exercising C2.

4-29. Commanders aggressively train to overcome institutional obstacles to mission command (frequent deployments of organizations comprised of units that have not trained together, personnel turbulence caused by operational commitments, constrained financial resources). In particular, commanders use training events to create common experiences that increase trust, foster teamwork and confidence, and allow commands to acquire competence in mutual understanding. Well-trained teams are able to communicate explicitly and implicitly, conduct decentralized operations, and achieve unity of effort in uncertain situations by operating within the commander's intent.

## REHEARSALS

4-30. A rehearsal is a session that occurs during preparation in which a unit or staff practices expected actions to improve performance during execution. They are the commander's tools used to ensure that staffs and subordinates understand the commander's intent and CONOPS. Rehearsals also synchronize operations at times and places critical to successful mission accomplishment. The extent of rehearsals depends on the time available and allows participants in an operation to become familiar with the plan. Rehearsals translate the plan into a visual impression that orients units, staffs, and individuals to their OE and to other units that will execute the operation. Finally, effective rehearsals further imprint a mental picture of the sequence of key actions within the operation and provide a coordination forum for subordinate and supporting leaders and units.

4-31. Rehearsals focused on CBRN-related, incident-response actions and linkages to C2 contribute to external and internal coordination. They accomplish the following:

- Reveal unidentified external coordination requirements.
- Help synchronize the operation at key points by identifying times and locations requiring coordination and solutions for coordinating actions.
- Support internal coordination by identifying tasks needed to accomplish external coordination.
- Update internal coordination techniques (synchronization matrix, decision-support template).
- Practice essential tasks (improve performance).
- Reveal weaknesses or problems in the CBRN plan.
- Coordinate the actions of subordinate CBRN support elements.
- Improve the warfighter's understanding of the CONOPS (foster confidence in warfighters).

4-32. At the tactical level, rehearsals include subordinate leaders briefing their planned actions sequence to the leader, and the leader briefing the higher headquarters command hierarchy.

## EXERCISES

4-33. The CBRN unit commander or staff can use major training events (situational training exercises, external evaluations, deployment exercises) to provide feedback and assist commanders in assessing the effectiveness of their leader, individual warfighter, unit adaptiveness, and maintenance training programs. Exercises enable units and individuals to—

- Establish and sustain their tactical and technical training proficiency by learning how to solve tactical problems and give appropriate and meaningful orders.
- Receive feedback on the quality of their decisions and obtain an understanding of the impact that the frictions of the OE have on their decisions.

4-34. Exercises produce adaptive leaders who are tactically and technically competent, are confident in their abilities, and routinely demonstrate initiative within the framework of the commander's intent.

## **HEALTH SERVICE SUPPORT**

4-35. According to FM 4-02.7, HSS is integrated into the preparation process to support unit readiness. Key elements include casualty estimation, prophylaxis (including immunizations), active medical surveillance, preventive medicine, diagnostics, mass casualty management, evacuation, and patient decontamination requirements for HSS operations. Unit plans should recognize that CBRN attacks have the potential to create mass casualties and that the treatment and evacuation of CBRN casualties will be difficult and hazardous to the patients, medical personnel, and facilities.

4-36. HSS may include support to evaluate CBRN exposure/contamination information and characterize effects and associated operational risk levels. This may also include the provisions of health risk assessments and exposure guidelines. The analysis of health and medical services should determine how well a unit can provide adequate health and medical care at the CBRN attack site and within the medical system.

4-37. The use of CBRN weapons or systems may create large numbers of casualties in short periods, compromise the quality and quantity of health care, pose a serious contamination threat to medical personnel, constrain mobility and evacuation, and potentially contaminate the logistical supply base. These factors have the potential of severely degrading health care delivery, and they require detailed planning. HSS analysis should observe preattack and postattack medical planning, to include how well a unit—

- Conducts prior coordination with subordinate, adjacent, and higher headquarters; HN, state, and local medical facilities; and aeromedical evacuation units.
- Trains medical teams in the identification, treatment, and handling of contaminated casualties.
- Detects contamination, supervises patient decontamination, and treats patients.
- Designates areas in medical facilities to segregate and treat contaminated patients.
- Assesses and identifies suspicious illnesses and diseases.
- Provides, stockpiles, and develops a plan for the distribution of antidotes, pretreatments, and prophylaxes for potential agents (including agents or antidotes from commercial or industrial sources) based on the existing threat.
- Conducts medical evacuation and incorporates contaminated patient transport and contamination control into litter and ambulance operations.



**This page intentionally left blank.**

## Chapter 5

# Chemical, Biological, Radiological, and Nuclear Execution Activities

This chapter provides an overview of CBRN execution activities that support C2 functions throughout the operations cycle. The CBRN shape function is predominantly composed of processes for the collection, processing, correlation, compilation, analysis, decisionmaking, and dissemination of CBRN data and information. This allows the commander to make the educated use of information to optimize the capability of U.S. forces and operate in a CBRN environment. The fusion of data, coupled with visualization and decisioning tools, provides the commander and CBRN staff tactical-level with capability employment planning data and considerations for how CBRN threats and hazards shape military operations; it imparts an understanding of where and when to expect CBRN hazards by applying CBRNWRS. During the execution phase, assessment activities occur during the preincident and postincident phases of operations. (See appendix M for execution activities.)

## INTELLIGENCE, SURVEILLANCE, AND RECONNAISSANCE INTEGRATION

- 5-1. ISR are preincident activities that facilitate the assessment of CBRN threats and hazards; they are key enablers that provide a visualization of the CBRN environment to the commander and CBRN staff. Visualization helps to develop a clear understanding of the current and predicted CBRN situation, envision the end state (mission accomplishment without CBRN casualties or operating tempo degradation), and anticipate the sequence of events that moves the force from its current state to the desired end state.
- 5-2. During execution, staffs continuously collect, assess, and evaluate CBRN-related information received from ISR collection requirements and friendly reports; and they use this information to update IPOE/IPB products, which contribute to the commander's situational understanding. IPOE/IPB produces an integrated picture of the OE, including operating surfaces and terrain, to support the production of predictive and dynamic (near-real-time) intelligence.
- 5-3. The intelligence cell evaluates the ongoing operation against the current picture produced by IPOE/IPB. It forecasts what, when, where, and how changes in the AO will occur based on this evaluation.
- 5-4. The current operations cell integrates the IPOE/IPB products, including forecasts of change and implications for future operations, with other relevant information into the operations staff estimate.
- 5-5. Commanders use the IPOE/IPB and other staff estimates to refine their visualization, assess the situation, and direct adjustments. Significant or forecasted changes in the CBRN environment or threat may result in changes to the order (adjustments).

5-6. The CBRN cell in the unit staff translates source information into an understanding of the CBRN threat and the AO for CBRN actions. This process includes tracking the status and allocation of CBRN resources and conducting activities to ensure the readiness and preparedness for the sustained effective performance of CBRN tasks within a CBRN environment. This process requires—

- Timely action to assess vulnerability.
- Specific COAs for reducing vulnerability and countering specific threats.
- CBRN warning and reporting on potential and actual CBRN attacks to facilitate risk assessments.
- Actions to minimize the short- and long-term health effects of toxic exposures.

5-7. Decisionmaking must take advantage of information available to plan, prepare, rehearse, and execute operations in a CBRN environment. Commanders and CBRN staffs must determine which inputs will affect a given decision point and the effectiveness of these inputs. They must also analyze execution requirements for typical decision points with relevance to CBRN contamination avoidance, CBRN protection, and CBRN decontamination. The application of these principles helps to minimize vulnerabilities, protect friendly forces, and maintain the force operating tempo to achieve tactical objectives while complicating adversary targeting.

5-8. The ability to recognize the presence or absence of CBRN threats and hazards in the AO through ISR TTPs is essential to CBRN contamination avoidance, FP, survival, and restoration. Actionable ISR inputs—

- Support the commander's execution decisions by fusing information from various sources.
- Establish requirements for other avoidance measures (sounding alarms, marking hazards, warning forces).
- Guide essential implementation measures designed to avoid or limit exposure (increased shelter use during CBRN employment windows).
- Provide key information for movement before, during, and after CBRN attacks.

5-9. Fundamentally, CBRN protection consists of those actions taken to prevent or mitigate hostile actions against personnel, resources, facilities, and critical information. These actions conserve force fighting potential for decisive application. Offensive and defensive measures are coordinated and synchronized to enable the effective employment of the force while degrading opportunities for the adversary. CBRN protection conserves the force by providing individual and collective-protection capabilities. In CBRN environments, the commander's COA must take into account a number of unique considerations that have a significant effect on FP. These include—

- Interdiction.
- Collateral damage planning and assessments.
- Early and sustained operations to disrupt or destroy CBRN capabilities.
- Multilayered defenses against CBRN weapons delivery.

5-10. After a CBRN attack, commanders and CBRN staffs must prioritize requirements to restore forces and operations to a near-normal capability. Decontamination operations are labor-intensive, and decisions will depend on—

- Agent type.
- Weather and terrain conditions.
- Extent of contamination.
- Enemy situation.
- Mission.
- Decontamination assets available.
- Level of contamination/exposure and associated degree of health and operational risk.
- Time and resources available to mitigate risk to lower levels.

---

*Note.* *Multiservice Tactics, Techniques, and Procedures for Chemical, Biological, Radiological, and Nuclear Contamination Avoidance; Multiservice Tactics Techniques, and Procedures for Nuclear, Biological, and Chemical (NBC) Protection; and Multiservice Tactics, Techniques, and Procedures for Chemical, Biological, Radiological, and Nuclear (CBRN) Decontamination* provide detailed TTP for the technical aspects of contamination avoidance, individual and collective protection, and decontamination.

---

## INCIDENT MANAGEMENT

5-11. Commanders must be provided with timely, accurate, and evaluated information on contamination from CBRN incidents (intentional or accidental). These incidents can have a significant effect on military operations, plans, and decisions. Prior planning and preparation processes (to include ISR operations and targeting) presume success, but there is always the chance that a CBRN incident will occur. CBRN incident management involves the response to a CBRN threat or hazard with known or unknown factors activated by trigger events (decision points). Trigger events help determine when the response to a CBRN incident begins and may prompt immediate or delayed response actions.

5-12. A CBRN incident is characterized on the basis of the intent, opportunity, and capability of the occurrence. There are three basic reasons why a CBRN incident happens, regardless of the type and nature—intentional, accidental, and natural—and the distinguishing difference between the three is the intent. Intentional releases against U.S. forces will normally be the only incident type that commanders will be required to respond to or support. Response to accidental and natural CBRN incidents is normally accomplished by local, state, and federal response units. Commanders whose units are exposed to accidental or natural CBRN hazards are responsible for the safety of their personnel. Terrorist acts involving CBRN are considered CBRN consequence management incidents. DOD support of a CBRN consequence management incident is limited to a few specially trained CBRN consequence management units. (See *Multiservice Tactics, Techniques, and Procedures for Chemical, Biological, Radiological, and Nuclear Consequence Management Operations*.)

5-13. An intentional CBRN incident is normally the result of an enemy's use of CBRN weapons, but may include the release of TIM from, an industrial facility. An intentional CBRN incident is the primary concern for commanders. Protecting assets from, and mitigating the effects of, intentional CBRN agent use by a hostile state or nonstate actor against U.S. forces is a function of the combating CBRN passive defense mission area.

5-14. An accidental CBRN incident is an event caused by human error or natural or technological reasons (spills, accidental releases, leakages). These accidental incidents are usually referred to as hazardous materials accidents.

5-15. A natural CBRN incident includes outbreaks of infectious diseases (severe acute respiratory syndrome, pandemic influenza).

---

*Note.* Other CBRN incidents that impact the agricultural and economic structure occur through livestock, crops, and contaminated foods. These types of incidents may occur accidentally or intentionally.

---

5-16. Monitoring and knowing when a trigger has occurred helps shape the ability of the force to respond. An effective response will drive more effective restoration operations, limit the severity of the CBRN event on operations, and reduce the overall number of casualties. Notification, warning, and reporting will trigger protective actions to prevent the exposure of resources. Most preincident activities occur during the planning and preparation phases, and they are predominantly functions of CBRN sense and CBRN shield. (For a more detailed discussion of preincident activities, see applicable Service doctrine.)

5-17. The impact of a CBRN incident can affect more than one command; therefore, each command affected requires relevant information on the CBRN attack (when, where, impact). Executing effective incident communications, IM, and information and intelligence sharing are critical aspects of C2 during postincident activities.

5-18. Establishing and maintaining a COP and ensuring accessibility and interoperability across the AO are principal goals of communications and incident management and key activities during postincident operations. The COP is a unique display of information that is accurate, timely, usable, complete, precise, reliable, and shared by more than one command.

5-19. CBRN-related information contributes to the COP and automated CBRNWRS/Health Plan Management System interoperability, providing the framework necessary to—

- Formulate and disseminate CBRN threat and hazard indications, notifications, and warnings.
- Formulate, execute, and communicate operational decisions at an operational area and between operational headquarters across the AO.
- Prepare for potential requirements and requests supporting CBRN capabilities.
- Develop and maintain SA.

5-20. CBRN shape functions, or monitoring designated elements of the COP that are tied to the commander's criteria for success, require special attention from staff officers during postincident operations. The focus of the CBRN staff is on collecting the critical information that the commander needs to mitigate the effects of the incident.

5-21. Postincident awareness is achieved by the information provided, but it takes an understanding of the information to make prompt, correct decisions (changing a route to avoid contamination, adjusting the MOPP level).

5-22. The COP also allows leaders to understand current CBRN logistics postures and supports the ability to respond to known requirements. Leaders at the tactical level will use the COP to analyze and share assessments through a collaborative planning process enabled by information technologies. This is made possible through a real-time, web-based information system that provides accurate, actionable visibility as part of a common logistics operating environment, effectively linking the operator and the logistician across joint forces and from the foxhole to the national level.

5-23. Leaders must be able to conduct rapid, tactical decisionmaking and commander action-centric operations, from physical rehearsals to virtual training and from static counterproliferations to battle command on the move. Terrain and weather form the foundation of the COP, the summation of critical combat information within the AO. The ability of the command to achieve information superiority; conduct precision strikes; and execute rapid, violent, decisive engagements will hinge on the quality, fidelity, and freshness of the COP. Accurate terrain and weather products, with great spatial and temporal details, are necessary to support network sensing, mission analysis, and the MDMP/MCPP.

5-24. As necessary, the CBRN staff recommends adjustment decisions to the commander based on its ongoing assessment and running estimate, in which the CBRNWRS plays a pivotal role. Maintaining the COP with manual or automated data inputs ensures that U.S. forces can make informed CBRN-related decisions. CBRNWRS input may include the following:

- Friendly CBRN air, maritime, and ground force tracks/locations within the operational area.
- Enemy air, maritime, and ground-force CBRN capabilities within the operational area.
- CBRN operational overlays.
- Meteorological and terrain overlays.
- CBRN-related nongovernmental organization products.
- Other information or graphic displays required.

---

**Note.** Common warfighting symbology standardization is provided by Military Standard (MIL-STD)-2525C. *Operational Terms and Graphics* sets forth doctrine for the USA and USMC in the use of land-based warfighting symbology.

---

5-25. Technical reachback is the ability to contact SMEs when a technical issue following a CBRN incident exceeds command and staff capability. During postincident activities, commanders and staffs maintain technical links with appropriate joint, federal, and state CBRN asset, and research, development, and technical communities to assure CBRN response success. Reachback should be conducted using established unit protocols.

## WARNING AND REPORTING SYSTEMS

5-26. During execution activities, CBRN warning and reporting is an IM function that entails collecting and analyzing data from assessments within CBRN functional areas (CBRN shape, CBRN sense, CBRN shield, and CBRN sustain) to support CBRN preparations based on plans, the commander's intent, and the operational context and situation. The CBRNWRS is being gradually developed to automate the process of providing relevant, precise, accurate, timely, usable, and complete CBRN defense-related information to the warfighter. The CBRNWRS must be tailored to fit the unique capabilities, needs, and operating procedures of specific AORs.

5-27. The CBRNWRS is the primary means of warning units of an actual or predicted CBRN hazard and provides the information needed to develop the COP and support the CBRN C2 process. It provides quality information to the right person, at the right time, and in a usable form to facilitate understanding and decisionmaking, allowing commanders and CBRN staffs to determine required protective measures and plan operations accordingly.

---

*Note.* The North Atlantic Treaty Organization (NATO) conducts CBRNWRS activities according to Standardization Agreement (STANAG) 2103/Allied Tactical Publication (ATP)-45(C), and U.S. forces have implemented this agreement in *Multiservice Tactics, Techniques, and Procedures for Chemical, Biological, Radiological, and Nuclear Contamination Avoidance*.

---

5-28. CBRNWRS capabilities include manual and automated processes in the creation, collection, and control; dissemination; and storage and retrieval of information obtained from affected forces, coalition partners, and appropriate nongovernmental organizations and indigenous agencies. Capabilities may range from detectors and alarms that are not integrated to fully integrated sensors at selected locations, allowing the commander and CBRN staffs to anticipate future conditions and accurately assess risks. The vertical and horizontal exchange of CBRN-related information relayed through the CBRNWRS keeps different commands, agencies, coalition partners, and functional/staff personnel informed. The CBRN staff determines the need for specific types of CBRN information (the "when" and "where" of the CBRN attack).

5-29. Currently, many CBRN agent detector and alarm arrays operate as independent units; therefore, when a CBRN attack is detected, only those personnel in the immediate vicinity hear the alarm. Adjacent units need to be notified by radio, wire communications, audible means, or verbal means. In contrast, other CBRN agent detectors may not be physically connected and may appear to be operating independently, but in actuality, they are operating as a network. For example, while a shipboard detector may not directly communicate with another detector on a vessel 40 miles away, the two ships are connected via data links and other communication networks. The ships are similarly connected to higher authority via the same means; therefore, each single ship's detector is not independent. CBRN calculations in support of CBRN hazard prediction are often done manually. (For a detailed explanation of the manual method, see existing doctrinal publications.)

5-30. The information received from an integrated detection network helps provide an assessment of the current situation by detecting/identifying CBRN threats and hazards in air, on water, or on land. The sensor network detects and identifies CBRN threats and hazards that are affecting personnel, equipment, or facilities and identifies the physical state of such hazards (gas, liquid, or solid). An automated CBRNWRS is also known as a CBRN IM system.

5-31. IM supports execution activities based on plans, preparation, the commander's intent, and the operational context and situation.

5-32. CBRN IM systems focus on implementing warning and reporting measures and providing a CBRN COP, which are displays of relevant CBRN information that facilitate collaborative planning and the assessment of the effect of a CBRN incident on operations.

5-33. CBRN IM systems—

- Provide a CBRN information-centric database, including facilities for information retrieval, linking CBRN sensors to C2 information systems and databases.
- Facilitate the fusion of sensor data to provide automatic alerts and inputs to hazard prediction.



- Generate CBRN information that is dynamic by the phase of operation, level in command, role, and function.
- Produce CBRN hazard templates and plume predictions overlaid on a digital map.

5-34. To assist commanders and improve and automate the information-gathering and -sharing process, several government and commercial off-the-shelf systems have been developed and are in use throughout the U.S. military.

---

*Note.* An automated version of the CBRNWRS (JWARN) is currently being integrated into existing information systems to collect, process, store, protect, display, and disseminate CBRN information.

---

5-35. As a postincident automated warning and reporting tool, JWARN provides an operational capability to employ CBRN warning technology for collecting, analyzing, reporting, identifying, locating, and disseminating CBRN, environmental, and TIM information. This information is an integral element of information technology systems, using near-real-time information.

5-36. JWARN functionality can be used at individual warfighter to strategic-level authorities to provide a means of informing friendly units about possible contamination. JWARN provides the capability to conduct analyses of CBRN incidents, ensuring that SA provides minimal risks to friendly forces. After a CBRN incident, tactical-level CBRN units (reconnaissance, surveillance, decontamination, and obscuration) conduct operations and use the JWARN capability to notify personnel and distribute gathered information to higher headquarters. Operations conducted include route decontamination; reconnaissance survey; contamination crossing, obscuration, MOPP, and heat stress analyses; and flame field expedient plans.

5-37. For JWARN to be an effective tool in CBRNWRS, users must understand how it works, the importance of the different messages, and their use at each echelon. The JWARN program is based on STANAG 2103/ATP-45C and specific, standardized NBC report formats. These standardized reports include:

- Observer's data.
- Evaluated data.
- Immediate warning data of predicted contamination and hazard.
- Reconnaissance, monitoring, and survey results.
- Areas of actual contamination.
- Detailed information.

---

*Note.* Each report has a specific use at different levels within the tactical and operational environments. See *Multiservice Tactics, Techniques, and Procedures for Chemical, Biological, Radiological, and Nuclear Contamination Avoidance.*

---

## HAZARD PREDICTION AND MODELING

5-38. To provide commanders with an analysis of CBRN hazards, predictions, and effects in their AO, CBRN staffs and CBRN reconnaissance units may use advanced CBRN modeling scenarios, in conjunction with JWARN, as a CBRN shape tool during execution activities. JWARN provides the ability to compute the transport and dispersion of chemical and biological (CB) agents and simulate hazards in a variety of scenarios. (See appendix F for JWARN capabilities.)

5-39. During the execution phase of the CBRN operations process, CBRN hazard and prediction modeling is capable of near-real-time COA analyses and predictive evaluations under CBRN situations and provides CBRN staff planners with the analytical capability to determine and assess the impact of a CBRN incident on military operations. (See appendix F for Service-specific CONOPS, programs of record, and emerging CBRN hazard and prediction modeling capabilities.)

## CASUALTY AND FATALITY MANAGEMENT

5-40. Tactical plans should recognize that CBRN attacks may produce mass casualties and mass fatalities. With the employment of CBRN weapons/agents, a mass casualty and/or a mass fatality situation can present itself at anytime and at any role of care.

5-41. The treatment for mass casualties is often limited to life- or limb-saving care, and triage must be conducted within strict guidelines. Medical staffs conducting triage should know the differences in triage priorities that occur, depending on which CBRN agent is suspected. For example, while it is important that patients be decontaminated before they are admitted to an uncontaminated area, radiation-contaminated casualties usually pose a low risk to health care workers, so treatment may be started before decontamination.

5-42. Mass fatalities from CBRN attacks require that contaminated remains be processed through the mortuary affairs decontamination collection point. In general, an appropriate medical authority (the theater mortuary affairs officer, medical examiner), possibly in coordination with the joint security coordinator, will determine the degree of hazard and appropriate disposition of human remains.

5-43. The movement of patients and human remains is normally a Service responsibility using organic assets (personnel, surface vehicles, and aircraft). This movement is complicated when the patients or human remains are contaminated. Personnel who are loading/unloading or moving contaminated patients and remains should be in appropriate personal protective equipment. The combatant commander (CCDR), with advice from the command surgeon and/or theater mortuary affairs officer, is responsible for moving casualties and human remains within theater and deciding the extent to which evacuation assets will be committed to contaminated areas. Evacuation/transportation assets should be designated as “dirty” after hauling contaminated patients or remains. Every effort should be made to limit the number of evacuation assets that are contaminated. (See FM 4-02.7 and JP 4-06.)

## RESTORATION OPERATIONS

5-44. Restoration operations are those actions taken by a military force immediately after a CBRN attack; it is the operational employment of forces to restore their combat capability to full operational readiness. Restoration operations provide a critical foundation for postconflict planning to eliminate adversary capabilities, restore forces and infrastructures to normal capability, and establish effective monitoring and other controls.

5-45. Timely restoration is essential. Restoration operations after a CBRN attack must include actions to—

- Reduce MOPP.
- Effectively treat CBRN-affected personnel.
- Decontaminate affected equipment.
- Conduct CBRN vulnerability and capability assessments.

5-46. Restoration operations include immediate measures for initial support response and measures taken thereafter to reestablish combat readiness and organizational functions. The execution of CBRN activities for the force and its components are continuously conducted from preincident to completion of restoration operations to deter or prevent multiple incidents, protect critical infrastructure, and support organizational restoration. Immediate and long-term restoration activities are defined as follows:

- **Immediate.** Command infrastructure has been returned to service and is capable of operations at some level. Activities, policies, or mitigation strategies aimed at restoration are considered achievable in 90 days or less. Immediate restoration activities within the impacted area also provide essential elements of information (EEI) needed by the command to facilitate the restoration of combat capability. Immediate restoration activities include the—
  - Safekeeping of vital resources, facilities, and records.
  - Improvisation or emergency acquisition of vital resources necessary for the performance of missions.
  - Capability to relocate essential personnel and functions to, and sustain performance of operations at, alternate work sites until normal operations can be resumed.



- **Long-term.** Command infrastructure has been returned to preincident condition or has the capacity to operate at preincident levels. Activities, policies, or mitigation strategies aimed at long-term restoration may take longer than 90 days. The capability exists to continue combat operations in a CBRN environment.

5-47. Restoration activities should also be coordinated with vulnerability reduction and mitigation measures as an ongoing assessment process. Failure to perform or sustain these functions would significantly impact the organization's ability to provide vital services or exercise authority, direction, and control.

## Appendix A

# Metric Conversion Chart

This appendix complies with AR 25-30 which states that weights, distances, quantities, and measures contained in Army publications will be expressed in U.S. standard and metric units. (See table A-1 for the metric conversion chart.)

**Table A-1. Metric conversion chart**

<i>U.S. Units</i>	<i>Multiplied By</i>	<i>Equals Metric Units</i>
Fahrenheit	Subtract 32, and multiply by 0.5556	Celsius
Miles	0001.609344000	Kilometers
Miles per hour	0001.609344000	Kilometers per hour
Nautical miles per hour	0001.000000000	Knots
Short tons	0000.001000000	Kilotons
Square feet	0000.836127000	Square meters
Square miles	0002.589988110	Square kilometers
Yards	0000.914400000	Meters
<i>Metric Units</i>	<i>Multiplied By</i>	<i>Equals U.S. Units</i>
Celsius	Multiply by 1.8000, and add 32	Fahrenheit
Kilometers	0000.621371000	Miles
Kilometers per hour	0000.621371192	Miles per hour
Kilotons	1000.000000000	Short tons
Knots	0001.000000000	Nautical miles per hour
Meters	0001.090000000	Yards
Square kilometers	0000.386102159	Square miles
Square meters	0001.195990000	Square yards

**This page intentionally left blank.**

## Appendix B

# Chemical, Biological, Radiological, and Nuclear Vulnerability Assessments

This appendix provides tools for conducting a CBRN vulnerability assessment and determining risks associated with vulnerabilities to a CBRN attack. It also provides the user with suggested TTP to mitigate and reduce these vulnerabilities. CBRN vulnerability assessment is a cyclic preventive-protection process that consists of the following key activities:

- Threat assessment (during planning).
- Vulnerability analysis (during planning).
- Vulnerability reduction (during preparation).

---

*Note.* See appendix D for threat and hazard assessments.

---

## VULNERABILITY

B-1. Once the credible threats are identified, a vulnerability assessment must be performed. The CBRN vulnerability assessment considers the potential impact of loss from a successful attack and the vulnerability of the facility/location to an attack. The impact of loss is the degree to which the mission of the unit is impaired by a successful attack from the given threat. A key component of the vulnerability assessment is properly defining the ratings for the impact of loss and vulnerability.

B-2. CBRN vulnerability assessment provides insight into the ability of the unit to mitigate likely CBRN threat situations and prompts the unit to develop procedures, acquire equipment, and/or take other actions to correct vulnerabilities before the mission is adversely affected and/or people are injured or killed. Knowing the risks and vulnerabilities in a CBRN environment allows commanders to determine the unit situation and provide options to mitigate those vulnerabilities.

B-3. The current and future CBRN threat and hazard is global in nature and ranges from low to high intensity. Terrorists may be encountered at any level of conflict. The proliferation of CBRN-capable nations in contingency regions and the ready availability of toxic CBRN materials increase the likelihood of U.S. forces being direct or inadvertent targets of attack. These attacks may range from limited use in terrorist actions to planned targeting in support of military operations.

B-4. Because CBRN proliferation is increasing, continental United States (CONUS) and outside continental United States (OCONUS) forces must be capable of accurately assessing the CBRN threat and hazard imposed by the opposing force and be capable of addressing unit vulnerability to attack.

B-5. When planning operations, commanders must consider the potential effects of CBRN weapons on personnel and equipment. In conventional operations, the concentration of forces increases the chance for success, but this same concentration increases the effects of CBRN attacks and the likelihood of their occurrence. Commanders consider the timing of force concentration to reduce the effects of a CBRN attack.

B-6. To assess a unit's vulnerability to a CBRN attack, the commander determines how well protected the unit is and the type and size of weapon likely to be used against it. The commander then weighs various COAs and determines which presents an acceptable risk to allow mission accomplishment. This whole process starts with an initial assessment of the CBRN threat during the IPOE/IPB and concludes with the CBRN staff identifying the friendly force, mission-critical vulnerabilities and recommended vulnerability reduction measures.

## LEVELS

B-7. CBRN vulnerability assessment processes have two levels of application: crisis action and deliberate. Time is the basic factor that contributes to the selection of the level of application used.

### CRISIS ACTION

B-8. Crisis action CBRN vulnerability assessment is an “on the run” mental or verbal review of the situation, using the basic CBRN vulnerability assessment process. The crisis action CBRN vulnerability assessment process is employed to consider vulnerabilities and risks while making decisions in a time-compressed situation. This level of CBRN vulnerability assessment is used during the execution phase of training or operations and in planning and execution during crisis responses. It is particularly helpful for choosing the appropriate COA when an unplanned event occurs.

### DELIBERATE

B-9. Deliberate CBRN vulnerability assessment is the application of the complete vulnerability assessment process when time is not critical. Deliberate vulnerability assessments primarily use experience and brainstorming to identify threats/vulnerabilities and develop reduction measures and controls and are, therefore, most effective when done in a group. Examples of deliberate applications include planning upcoming operations, reviewing SOPs, performing maintenance, conducting training, and developing damage control or disaster response plans.

B-10. Whether conducting crisis action or deliberate planning to support CBRN vulnerability assessments at the tactical level, operation plans or operation orders are prepared and coordinated for the support of assigned missions. To support operation plan and OPORD development, COAs are developed within the framework of the assigned objective or mission, forces available, and commander’s intent.

B-11. To develop COAs when confronting a CBRN threat, the CBRN staff must focus on the key information necessary to make decisions.

B-12. A valid COA at the tactical level should be—

- **Suitable.** It must accomplish the mission (even in a CBRN environment) and comply with the supported commander’s guidance.
- **Feasible.** It must accomplish the mission within established time, space, and resource constraints. The commander and staff also assess the potential impact of casualties, contamination, and degradation.
- **Acceptable.** It must balance the cost with the advantage gained by executing a particular COA. The impact of the vulnerability reduction and mitigation measures is considered in this review.
- **Distinguishable.** Each COA must be significantly different from the others.
- **Complete.** It must incorporate major operations and tasks to be accomplished, to include considerations (forces required, employment concept, time estimates, desired end state).

B-13. The COA development and analysis are synchronized within the staff to help ensure the unity of effort and direction.

## FACTORS

B-14. The CBRN vulnerability assessment provides the commander with an estimate of the potential severity of a CBRN attack or release. Threat assessment and vulnerability analysis occur during the planning component of the operations cycle; vulnerability reduction occurs during preparation once the commander provides guidance on the acceptable level of risk. (See figure B-1 for an illustration of the vulnerability assessment process.)

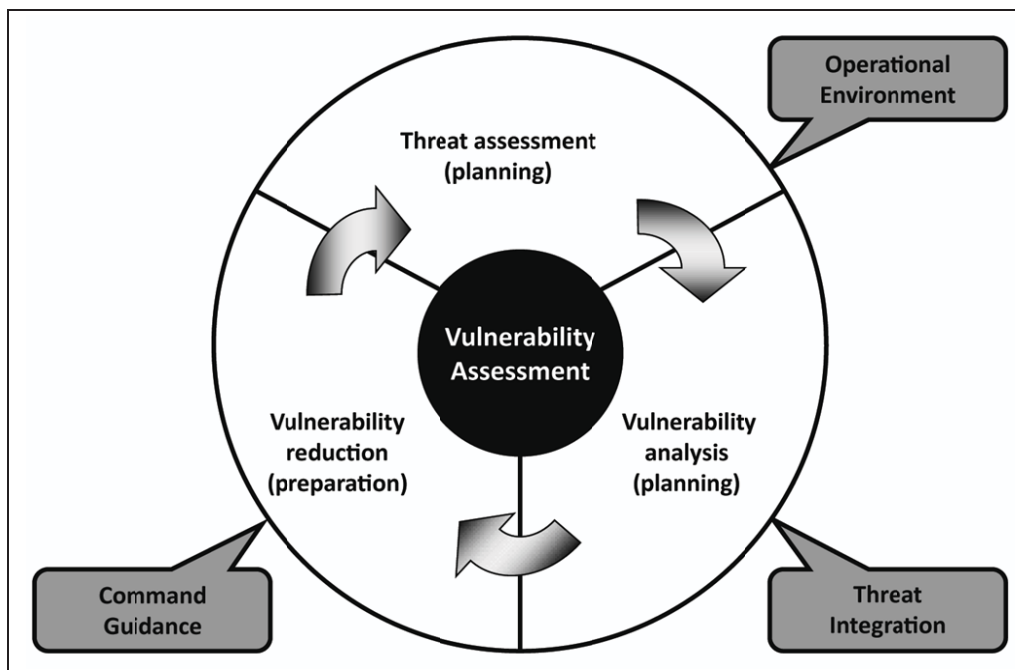

Figure B-1. CBRN vulnerability assessment process

## PRODUCTS AND FUNCTIONS

B-15. The CBRN vulnerability assessment is conducted by integrating the specific threat assessment with the analysis of specific vulnerabilities and identification of potential vulnerability reduction measures or, more specifically, the ability of the force or facility to protect against and/or mitigate the CBRN threat or hazard. The end state during the planning phase of the operations cycle is typically an estimate and recommendation to the commander on the priorities for vulnerability reduction. (See appendix D for threat assessments.)

## THREAT ASSESSMENT

B-16. The assessment process is designed to satisfy the commander's intent and reflect the main effort designation. Information regarding named areas of interest (NAIs) and target areas of interest and their constituent critical elements (C2 facilities, mobility corridors, troop concentrations, assembly areas) will suggest the CBRN threat or hazard. Define the CBRN threat or hazard in terms of the following characteristics:

- **Lethality.** Lethality is the ability of a hazard to cause death without treatment. The lethality of a hazard can be measured by its case fatality rate and the speed of death.
- **Morbidity.** Morbidity is the severity and duration of health effects without treatment.
- **Communicability.** Communicability is the ability of the hazard to cause secondary cases without quarantine or barrier nursing.
- **Persistence.** Persistence is the degree of continuing risk of exposure to individuals related to environmental exposures (air, water, soil, food, vectors, animals, and bodily fluids).

## VULNERABILITY ANALYSIS

B-17. The CBRN vulnerability analysis assesses the strengths and weaknesses of the CBRN protective posture. The adequacy of individual and collective protection, detection, and decontamination resources against possible accidental releases is also considered.

### VULNERABILITY REDUCTION

B-18. The commander and his/her CBRN staff use CBRN vulnerability analysis as an aid in developing vulnerability reduction measures to counter the CBRN threat and improve the command FP. The commander will decide which vulnerability reduction measures to implement (preattack, during attack, or postattack) based on considerations of the OE.

### RECOMMENDATIONS

B-19. The end states of vulnerability assessments are the coordinated CBRN, medical, and intelligence staff recommendations to the commander on vulnerability reduction measures. The recommendations apply the commander’s intent and guidance on acceptable risk and vulnerability reduction measures.

### ANALYSIS

B-20. CBRN vulnerability analysis is a continuous and integrated process of compiling and examining information on the protective posture of a unit or activity. The process assesses multiple factors (antiterrorism [AT], FP, medical surveillance, CBRN defense capabilities [strengths and weaknesses] of a force or activity). The assessment provides the commander with an estimate of the potential severity of a CBRN attack or accidental release. (See figure B-2 for a sample CBRN vulnerability analysis matrix.)

<i>Protective Posture<sup>1</sup></i>		<i>Detection Posture</i>		<i>Immunization (Against Predicted Agents)</i>		<i>Hygiene</i>		<i>Time and Weather</i>	
<i>Relative Value</i>									
Hardened Infrastructure COLPRO MOPP3/4	2	JWARN BIDS Portal Shield IBADS JBPDS	2	Complete (90 percent or greater)	2	Good	2	Unfavorable for CBRN use	2
Semi-Hardened Infrastructure JECF MOPP1/2	4	Less than two of the detection systems above	4	Incomplete (less than 90 percent)	4	Average	4	Marginal	4
Shelter in Place MOPP Ready	6	None	6	None	6	Poor	6	Favorable for CBRN use	6
<b>Relative Values = Subjective Rating</b>						Minimal actions from these ratings are described below.			
8–15		Low							
16–23		Medium							
24–30		High							
<p><b>Low:</b> Maintain the current efforts. Attempt to improve the areas that are weak.</p> <p><b>Medium:</b> Analyze the current actions, and increase the efforts to reduce the rating. Concentrate on the areas where immediate control is possible (protection capabilities, MOPP levels, hygiene, detection assets).</p> <p><b>High:</b></p> <ul style="list-style-type: none"> <li>Analyze the current actions, and immediately increase the efforts to reduce the rating. Concentrate on the areas where immediate control is possible (protection capabilities, MOPP levels, hygiene).</li> <li>Determine the OPCON of the detection assets. If assets are not under OPCON, determine where they are and if the unit is inside the detection “umbrella.”</li> <li>Determine if the assets can be repositioned to cover the operation.</li> <li>Determine if immunization rates are satisfactory for the total force. Typically, contract workers from whatever source require more immunizations than U.S. military personnel. Provide immunizations as soon as medical and political situations allow. Remember that immunizations require time to work effectively.</li> </ul>									

Figure B-2. Sample CBRN vulnerability analysis matrix



<p>Step 1. Begin at the left column, and add the relative values from each column:</p> <ul style="list-style-type: none"> <li>• The unit does not have hardened or semihardened infrastructures.</li> <li>• The unit is currently in MOPPO.</li> <li>• The unit has a biodetection unit attached.</li> <li>• Approximately 30 percent of the unit has been immunized.</li> <li>• The unit practices average hygienic measures.</li> <li>• The weather and time are favorable for enemy CW agent use.</li> </ul> <p>Step 2. Add the values as follows:</p> <ul style="list-style-type: none"> <li>• 6 for protective posture.</li> <li>• 4 for detection posture.</li> <li>• 4 for immunization.</li> <li>• 4 for hygiene.</li> <li>• 6 for time and weather.</li> </ul> <p>Total equals 24 (high vulnerability).</p> <p><sup>1</sup>If the protective capability and posture provide the required protection for the predicted agent, use a value of 2.</p>	
<b>Legend:</b>	
BIDS	Biological Integrated Detection System
CBRN	chemical, biological, radiological, and nuclear
COLPRO	collective protection
IBADS	Instantaneous Bio-Aerosol Detector System
JBPDS	Joint Biological Point Detection System
JCEP	joint expeditionary collective protection
JWARN	Joint Warning and Reporting System
MOPP	mission-oriented protective posture
OPCON	operational control

**Figure B-2. Sample CBRN vulnerability analysis matrix (continued)**

B-21. The CBRN vulnerability analysis represents an ongoing process and is a key first step in developing the CBRN defense plan. The CBRN defense plan is also continually updated to reflect the heightened or lowered defense capabilities of a force. There is no difference in vulnerability analysis procedures among chemical agents, biological toxins, radiological hazards, and nuclear attacks.

B-22. Upon completion of the initial CBRN vulnerability analysis, the staff revises or develops the CBRN defense plan. The CBRN defense plan should provide tiered sets of response actions. The unit, activity, installation, base, ship, or port can then take the appropriate measures commensurate with the estimated severity of the existing CBRN threat level.

B-23. Unit vulnerabilities may change based on—

- IPOE/IPB reassessments of adversary intent.
- Implementation of vulnerability reduction measures.
- Reduction of protective capabilities.
- Change in friendly force capabilities (increased CBRN training, enhanced proficiency).

B-24. The goal of the CBRN vulnerability analysis is to enable accomplishment of the assigned mission with minimal disruption and degradation. CBRN vulnerability analysis is conducted by assessing multiple factors, which may include assessing the mission of the unit/activity, analyzing the critical assets and infrastructure, and analyzing the ability of a unit/activity to respond to a CBRN threat.

**UNIT/ACTIVITY MISSION ASSESSMENT**

B-25. The mission vulnerability analysis assesses the mission of the unit in relation to the CBRN threat. The analysis also assesses the value of vulnerability reduction measures in terms of lost or reduced mission effectiveness. The commander then assesses the tradeoffs and the acceptable risk to units, facilities, and personnel given the potential estimated degradation in mission effectiveness.

## CRITICAL ASSETS AND INFRASTRUCTURE ANALYZATION

B-26. This analysis identifies critical assets and infrastructures (food and water sources) located within, on, and adjacent to the unit, activity, installation, base, ship, or port (high-value targets, lines of communications). It addresses the impact of temporary or permanent loss of critical assets or infrastructures on the ability of the unit, activity, installation, base, ship, or port to perform the mission. The staff determines and prioritizes critical assets. The commander approves the prioritized list. This assessment—

- Selects and prioritizes critical assets.
- Determines whether critical functions can be duplicated under various CBRN attack or accidental-release scenarios.
- Determines the time required to duplicate, recover, or restore critical assets or infrastructure if temporarily or permanently lost.
- Determines the vulnerability of critical assets or infrastructures to CBRN attack or accidental release.
- Determines the priority of response to critical assets and infrastructures in the event of CBRN attacks or accidental releases.

## UNIT/ACTIVITY ABILITY TO RESPOND TO A THREAT

B-27. This analysis determines the ability to plan for and respond to threat CBRN attacks or accidental releases impacting critical assets and infrastructures. The planning and response analysis examines passive defense measures and determines how well they are integrated into representative functional areas. The CBRN training readiness and proficiency must be analyzed when conducting the vulnerability assessment for each functional area outlined below.

### Personnel

B-28. The vulnerability analysis compares the number of personnel and units available to the number required to effectively respond to a CBRN attack or accidental release. Personnel and elements assigned or identified to respond to a CBRN attack may be subordinate to, or augmented by, HN, local, state, federal, or adjacent units.

### Intelligence

B-29. The vulnerability analysis of intelligence focuses on the organization's ability to gather, evaluate, and disseminate CBRN threat information. It includes passive and active intelligence collection, the analysis of existing intelligence, and the nomination of intelligence collection efforts through the determination of information requirements, including priority intelligence requirements and specific information requirements.

### Operations, Command, and Control

B-30. The vulnerability analysis of planning also examines how a unit, activity, installation, base, ship, or port prepares to respond to an attack. While the preponderance of the actions is preincident, planners cannot disregard the continuous and ongoing nature of planning. In the event of a CBRN attack or accidental release that could impact military activities, the unit or activity must plan for and coordinate with a large contingent of internal and external support organizations for an effective response. The subtasks can include operation plans with medical and mortuary affairs annexes, operation orders, memorandums of agreement or understanding, C2 responsibilities, conventional vulnerability assessments, emergency operations center (EOC) functions, information dissemination, warning and reporting, and training exercises. An analysis of these subtasks for completeness, relevance, and effectiveness is considered when conducting a vulnerability analysis. Training must also be assessed to determine if the unit is trained and ready.

## Logistics Support

B-31. The analysis of logistics support looks at the operational support required to respond to and recover from a CBRN attack or accidental release. This includes supporting logistics infrastructure and the ability to obtain, maintain, store, move, and replenish material resources. For example, transportation support is required to move assets (human and materiel) in response to a CBRN attack or accidental release. This includes the ability to protect the transport means and the operators during the response support. A CBRN environment should also increase the importance of alternative modes and routes. This makes centralized movement control imperative.

## Communications

B-32. Analyzing communications capabilities is vital to establishing the effectiveness of CBRN defense. An organization CBRN defensive capability must have the communications architecture and interfaces (JWARN) to support CBRNWRS requirements. A crucial aspect of implementing the plan is establishing, maintaining, and controlling communications among the forces in the incident area, the operations center, C2 elements, and CBRN response elements. Communications personnel must be able to respond to changing needs during the incident, maintain the existing infrastructure, respond to changing needs over a prolonged period, and maintain control of incoming and outgoing communications and communication channels included in the CBRN defense response plan.

## Attack or Accidental-Release Response

B-33. The response analysis addresses the ability of the unit or activity to take avoidance, protection, decontamination, or contamination control and other countermeasures to respond to a CBRN incident. Unit, activity, installation, base, ship, or port personnel should be trained to properly respond to, and notify the proper authorities of, a suspected or actual CBRN attack or accidental release. The proper authorities would then activate the response plan. A comprehensive response plan addresses the full spectrum of incidents that may occur. For example, an accidental release response capability includes the ability to detect an oxygen-deficient explosive or flammable atmosphere. Commanders should devise plans to achieve minimal mission degradation, as appropriate. Observer reports, physical evidence, and samples are important in documenting the attack; and the analysis should assess how well the unit plans address these representative functions.

## Security

B-34. The security plan must be analyzed to identify the unit's ability to safeguard personnel, limit exposure, and restrict access at the site of the attack. Sufficient security forces must be organized, trained, manned, and equipped to react to security events involving CBRN weapons and to protect the physical security interests of the command. Additionally, security forces should receive training that prepares them to respond to CBRN attacks or accidental-release incidents.

## Decontamination Assets

B-35. The analysis of decontamination assets should include how well a unit can detect contamination, effect rescue, render lifesaving first aid, and provide decontamination support.

## Health Service Support

B-36. The analysis of health and medical services should determine how well a unit can provide adequate preventive medicine measures, health care, and medical care following a CBRN attack or accidental release at the incident site and within the medical system.

## Support Services

B-37. Support services coordinate efforts to provide shelter, food, and emergency relief supplies following a CBRN attack or accidental release. The provision of emergency shelter for CBRN attack or accidental-release victims includes the use of preidentified shelter sites in existing structures, the creation of

temporary facilities (tent cities), the construction of temporary shelters, and the use of similar facilities outside an area affected by a CBRN attack or accidental release if evacuation is necessary. A combination of fixed sites, mobile feeding units, and bulk food distribution is available to provide food to victims and emergency workers, if needed.

### **Public Works, Civil Engineers, and Fixed-Site Engineers**

B-38. Public works should ensure that facilities and supporting infrastructures remain operational, damage is remedied or mitigated, and the full recovery of affected elements is accomplished in a timely manner to allow for the recovery of unit operations after a CBRN attack or accidental release.

### **Support Functions**

B-39. An analysis of how a unit, activity, installation, base, ship, or port plans for and integrates support assets into its overall CBRN defense response plan should be conducted. An organization that takes a comprehensive approach to CBRN planning can take advantage of shared capabilities, resulting in the reduced expenditure of limited and finite resources.

### **Restoration and Recovery**

B-40. The analysis of restoration and recovery procedures gauges the capability to recover from the temporary or permanent loss of critical assets and infrastructures due to a CBRN attack or accidental release. Staffs establish restoration and recovery procedures to ensure the continued ability to perform ongoing and future missions. An analysis of how well a unit, installation, activity, base, ship, or port performs restoration and recovery procedures should be completed.

### **Mortuary Affairs**

B-41. This function includes the integration of mortuary affairs operations, to include the handling of contaminated remains. This in itself may affect CBRN vulnerability reduction measures. (See JP 4-06 for information on the decontamination of contaminated remains.)

### **Explosive Ordnance Disposal**

B-42. The unit or activity response plan integrates the capability of EOD assets. The possibility of unexploded ordnance (UXO) and secondary devices makes the integration of EOD capabilities essential.

### **Installation, Activity, and Fixed-Site Emergency Responders**

B-43. The unit or activity response plan integrates the capability of emergency responders (fire and rescue, emergency services, emergency medical services, hazardous materials teams) to respond to an incident. The integration of these capabilities saves lives and minimizes property damage.

B-44. CBRN vulnerability analysis definitions are as follows if a CBRN attack or accidental release occurs during a mission:

- **High.** High vulnerability would generally be expected to result in—
  - The potential loss of the ability to accomplish the mission.
  - The probability of critical loss of equipment or personnel.
- **Medium.** Medium vulnerability would generally be expected to result in—
  - Significant degradation of mission capabilities in terms of the required mission standard.
  - The inability to accomplish all parts of the mission.
  - The inability to complete the mission to standard.
- **Low.** Losses would generally be expected to have a negligible effect on mission accomplishment.

B-45. CBRN vulnerability analysis specifically focuses on casualty estimates. The basic steps for casualty estimation are estimating the delivery capability, generating effects information, and estimating casualty effects downwind. The casualty estimate process relies on thorough IPOE/IPB, enemy and physical environmental assessments, and friendly mission analysis. In many cases, the enemy's primary objective may not be casualty generation. It may be target contamination and the degradation of mission capabilities. When critical equipment, facilities, or terrain are contaminated, operating tempo may slow dramatically. This is caused not only by casualties, but also by MOPP degradation, decontamination requirements, psychological impacts, and mission adjustments in response to the attack or anticipated attacks.

B-46. The basic inputs for determining casualty effects are anticipated (or actual) friendly target size, anticipated agent and delivery system, and weather. Additional considerations may include individual protection, collective protection, and specific response actions. (See FM 4-02.7 for casualty estimation.)

B-47. Apply rating measures in relationship to the probable agent of choice. Be aware that ratings do not consider troop motivation/morale factors. The final rating provides an estimate and can be used as one basis to support the vulnerability analysis process.

## CHEMICAL AGENTS

B-48. Unit vulnerability to a chemical attack depends primarily on the protection the unit has taken and the type and amount of chemical agents delivered. For nonpersistent agents, the risk of casualties to units in MOPP4 is negligible. This is also true for persistent agents if appropriate and timely decontamination measures are taken. Persistency, as defined in *Potential Military Chemical/Biological Agents and Compounds*, is an expression of the duration of effectiveness of a chemical agent. This depends on physical and chemical properties of the agent, weather, methods of dissemination, and conditions of terrain. Nonpersistent agents generally include choking agents, blood agents, and G-series nerve agents. Persistent agents generally include blister agents, viruses, soman, and thickened nerve agents. If personnel are forced to stay in MOPP gear, performance is degraded and heat casualties may occur. (See *Multiservice Tactics Techniques, and Procedures for Nuclear, Biological, and Chemical (NBC) Protection* for detailed information on degradation factors.) The commander must achieve a balance between reducing the number of casualties from the attack, avoiding heat casualties, and reducing individual performance degradation.

## BIOLOGICAL AGENTS

B-49. Biological agents have the potential to cover thousands of square kilometers. Infective doses can be provided with a very small volume of biological agent due to the organism's microscopic size, its ability to replicate in victims, its potential transmissibility, and the high levels of toxicity in comparison to classic chemical weapons.

B-50. A biological attack is not likely to be identified until medical surveillance systems respond to patients presenting with clinical symptoms or until biological point detection systems provide a presumptive identification result that will likely be used to support detect-to-treat recommendations. Analyzing vulnerabilities relative to biological attacks or hazards relies heavily on thorough intelligence to assist commanders with decision support information for the following considerations:

- Immunization level (availability of prophylaxes for anticipated agents).
- MOPP levels.
- Detection posture (deployed biological detection capability [dry filter units, the Joint Biological Point Detection System]).
- Maneuver (mobility) status (fixed sites are static).
- Hygiene practices.
- Time and weather.

## NUCLEAR AND RADIOLOGICAL THREATS AND HAZARDS

B-51. Analyzing the vulnerability to nuclear threat and radiological hazards addresses the impacts from blasts (shock waves), thermal radiation (high-intensity light and heat), initial radiation (within the first minute after detonation), residual radiation (fallout and induced radiation), and electromagnetic pulse. The

intensity of nuclear explosion effects varies with the weapon yield and type of burst. The severity of their impact on friendly operations is, in part, a function of activities (training readiness, defensive measures taken to reduce vulnerability).

## VULNERABILITY REDUCTION PROCEDURES

B-52. CBRN vulnerability reduction measures are risk-based decisions made by the commander after the CBRN staff conducts the CBRN vulnerability analysis. Selected CBRN vulnerability reduction measures could include the following:

- Adjusting protective postures.
- Changing the disposition of units (dispersed versus clustered).
- Identifying NAIs at probable launch or use locations.
- Conducting medical countermeasures (prophylaxis, immunization, medical treatment).
- Conducting the assessment of friendly force CBRN protection, detection, identification, and warning.

B-53. As CBRN vulnerability reduction measures are implemented, the vulnerability of a unit or activity to CBRN attacks or accidental-release events should be diminished. Commanders must weigh the cost of vulnerability reduction measures against the impact of implementing these measures. The commander determines his/her level of acceptable risk and the level of effort required for CBRN vulnerability/risk reduction measures.

B-54. Active measures prevent the enemy from using CBRN weapons; passive measures increase survivability. Individual and unit collective measures are only discussed briefly in this appendix. (See *Multiservice Tactics Techniques, and Procedures for Nuclear, Biological, and Chemical (NBC) Protection*.)

### ACTIVE MEASURES

B-55. Active measures are those measures taken to find and destroy the munitions or delivery systems. The destruction of delivery systems and munitions is the best method of reducing the chance of being attacked.

### PASSIVE MEASURES

B-56. It is not possible to destroy all threat CBRN munitions and/or delivery systems. Therefore, units must avoid being targeted and take precautions to reduce the effects of an attack if one does occur. These are passive measures. Units must use passive measures as part of normal operations to reduce the effects of operating under CBRN conditions.

### Plan Ahead

B-57. Tasks may become more complicated in a CBRN environment due to the degradation caused by the use of protective equipment. (*Multiservice Tactics Techniques, and Procedures for Nuclear, Biological, and Chemical (NBC) Protection* contains tables to help commanders estimate how long it takes to accomplish missions in a CBRN environment.) Commanders must take time to carefully evaluate COAs and allow for the additional time requirement. This is commonly referred to as war gaming. A bad decision could cause the unit to become contaminated or suffer casualties. Use the CBRN threat status for planning and stocking CBRN defense equipment. Units must prepare to continue the mission after a CBRN attack. Following an enemy CBRN strike, commanders must quickly assess the damage and reconstitute lost or weakened units.

### Avoid Detection

B-58. Avoiding detection is the best way to prevent CBRN attacks. Do this by employing good operation security measures. These include camouflage, light discipline and, especially, signal security. Active and passive measures must be used to prevent the enemy from gaining target information. Use defensive electronic warfare (electronic countermeasures and electronic counter-countermeasures) to reduce the



chances for identification and location. Once a CBRN attack is detected or suspected, commanders should consult higher headquarters for guidance if unit displacement is necessary.

### **Provide Warning**

B-59. If the unit is unable to avoid a CBRN attack, early warning of hazards in the AO is very important. The CBRNWRS notifies units that adjacent units have been attacked or that a downwind hazard is present. Automatic alarms positioned upwind to detect the arrival of an agent cloud may warn of probable attacks. When no CBRNWRS warning is received, these alarms let units adjust MOPP levels to meet the threat. Troops must be able to identify CBRN attacks and take appropriate actions. CBRN reconnaissance teams using the CBRN Reconnaissance System alert units on the move before they enter contaminated areas.

### **Maintain Discipline**

B-60. The unit must maintain discipline and confidence in their ability to survive and operate if they are to overcome the shock of a CBRN attack and continue the mission. Troops must be conditioned physically and mentally to wear MOPP gear and function in for extended periods. Commanders must be able to rely on their troops to wear MOPP gear, when required, and to remain in MOPP until cleared to reduce the level. Again, plan ahead. Develop MOPP acclimation plans within the unit. Use these plans whenever possible during unit training. Use the information contained in *Multiservice Tactics Techniques, and Procedures for Nuclear, Biological, and Chemical (NBC) Protection* to assist in developing a unit acclimation plan.

### **Seek Protection**

B-61. Foxholes with overhead cover and shelters offer good protection against the explosive and liquid effects of CB weapons. However, overhead cover (tents, tarpaulins, ponchos) offers at least some protection from liquid chemical agents. Use CBRN protective covers whenever possible.

### **Disperse**

B-62. Installations and troops in compact assembly areas are vulnerable to CBRN weapons. Commanders must determine how much dispersion is needed. Dispersion must reduce vulnerability, but not hinder operations or prevent the unit from concentrating when necessary. Supplies must be dispersed so that they will not all be destroyed at once. This especially includes food; petroleum, oils, and lubricants; and ammunition. The more dispersed a unit is, the longer it will take to do even routine tasks. The degree of acceptable dispersion depends on METT-TC/METT-T.

### **Remain Mobile**

B-63. Tactical mobility gives the commander the best chance for avoidance. Constant movement prevents the enemy from pinpointing locations and accurately employing CBRN weapons. However, the AO will be a difficult place in which to maneuver. Units will have to deal with obstacles, including contaminated areas, tree blowdown, urban rubble, fires, flooding, fallout, and craters. CBRN reconnaissance teams and the serving intelligence staff officer can provide useful information. The best source of information on mobility routes, however, is the movement control center.

### **Cover Supplies and Equipment**

B-64. Store supplies and equipment under cover to prevent contamination. Buildings offer excellent protection. CBRN protective covers, tarpaulins, pallets, packing materials, dunnage, and plastic can be used. Field-expedient covers, especially canvas and cardboard, provide protection from liquid agents for short periods. Although contamination seeps through covers, the CBRN protective cover will provide protection for up to 24 hours. Units must replace the covers as soon as possible after heavy contamination. Canvas will keep out more than 95 percent of liquid contamination if it is removed within 60 minutes after the attack. Although these covers may provide protection against liquid agents, a contact hazard will remain until the agent on the ground and the protective cover has weathered.



## Limit Exposure

B-65. Plans should include postattack procedures for limiting exposure to CBRN threats and hazards. The longer a person is exposed to CBRN contamination, the greater the chance of becoming a casualty. Only personnel required to accomplish a mission are sent into a contaminated area. Limit exposure with time. By waiting to enter a contaminated area, the contamination level and chance of exposure are usually reduced by time. Exposure can also be accidental. Personnel may not know that equipment is contaminated. Usually, this can be prevented by always marking contaminated equipment, but there are places where CBRN contamination hazards can accumulate (air filters). Engines have air filters, which trap CBRN contaminants. These contaminants accumulate. Therefore, even if the hazard area is small, it can be deadly. Persons working around equipment should be aware of hidden hazards. Always dispose of contaminated collectors (air filters) as contaminated waste.

## Prevent the Spread of Contamination

B-66. Limit the number of personnel and amount of equipment in the contaminated area. Confine CBRN contamination to the smallest area possible. This begins with monitoring to determine the amount and extent of contamination. Units moving from a contaminated area into a clean area should decontaminate at or near the edge of contamination. Mark contaminated areas, and report them to higher headquarters and adjacent units to prevent them from entering the contaminated area unknowingly. If the situation permits, contaminated material can be left in the area and allowed to weather. If the equipment is mission-essential, it must be decontaminated or moved to the rear for decontamination. Decontaminate as far forward as possible. If contaminated material must be moved, the unit runs the risk of transferring contamination to road networks or ground surfaces. The risk of contamination transfer is proportional to the amount of contaminant on the material, location of the contamination, type of contamination, and type of surface on which the contaminant is present. When moving this equipment—

- Notify the movement control center of contaminated vehicles or contaminated routes.
- Use as few transport vehicles as possible.
- Use one route (especially around congested areas).
- Monitor the route periodically for contamination.
- Cover the material to keep contaminants from being blown onto the road. (Weigh the risk of ground contamination against the additional burden of decontaminating/disposing of potentially contaminated covering material.)
- Warn personnel downwind if a vapor hazard is present.
- Monitor and decontaminate transport vehicles before transporting noncontaminated material.
- Ensure that transport crews wear appropriate MOPP gear.

B-67. Burn or bury contaminated or waste material when it must be destroyed. Agents destroyed by burning produce a vapor hazard—if material is burned, send a warning to downwind units. Burial is effective for contamination. Mark and avoid the area where contaminated waste is buried. The procedures for marking contaminated-waste burial sites are outlined in *Multiservice Tactics, Techniques, and Procedures for Chemical, Biological, Radiological, and Nuclear (CBRN) Decontamination*. This consists of submitting an NBC-5 Chemical Report outlining the contaminated-waste burial site. However, this report must be sent by the chemical, biological, radiological, and nuclear center (CBRNC) so that a line item alpha (strike serial number) may be assigned. The unit that closes the decontamination site must notify the CBRNC.

## **Appendix C**

# **Planning Processes**

This appendix provides tools to assist in moving the decisionmaking process from concept to execution. Decisionmaking is the cognitive process leading to the selection of a COA among variations—then knowing when and what to decide. It includes understanding the consequences of decisions. Decisions are the means by which a commander translates his/her visions of the end state into action. Planning considerations will revolve around the CBRN passive defense activities common to military missions. The planning process does not, for example, single out weapons, WMD elimination operations, sensitive-site exploitation, or even CBRN consequences, since other multi-Service tactics, techniques, and procedures (MTTPs) address the unique planning considerations for these missions. Many aspects of military operations (movement rates, fuel consumption, weapons effects) are quantifiable. They are part of the science of war. Other aspects (impact of leadership, complexity of operations, uncertainty of enemy intentions) belong to the art of war. It is essential that leaders, from the newest Service member to senior officers, familiarize themselves with the art of clear, logical thinking. It is more valuable to be able to analyze one battle situation correctly, recognize its decisive elements, and devise a simple, workable solution for it than to memorize the doctrine written about war.

### **REQUIREMENTS**

C-1. CBRN operations require detailed planning to be successful. The planner must consider the hazards that may result from CBRN contamination. Assessments include mission analysis, COA development, and the analysis and comparison of enemy and friendly COAs. CBRN planning is dynamic and continuous from preattack to postattack. The unit CBRN personnel and staff work together to ensure that CBRN planning is fully integrated into deliberate and crisis action planning.

### **TACTICAL PLANNING**

C-2. At the tactical level, CBRN planning takes into account strategic- and operational-level planning. Tactical-level CBRN defense planning focuses on ensuring that commanders can accomplish their mission-essential tasks in CBRN environments.

C-3. The size and location of the AO are influenced by the physical location of adversary land, air, naval, and space that could pose a direct threat to the security of the friendly force or the success of its mission.

C-4. The extent to which the effects of the OE are analyzed at the tactical level largely depends on the mission and planning time available. At a minimum, tactical-level forces should analyze the OE in terms of military objectives; avenues of approach; and the effects of a CBRN environment on personnel, military operations, weapons systems, and force mobility.

C-5. The tactical-level assessment of a military adversary should concentrate on factors (capability, disposition, tactics, and training status of tactical units or factional groups that could interfere with mission accomplishment). Also, units should include an assessment of potential TIM hazards from local activities (industrial pipelines, storage and shipping facilities).

## CONSIDERATIONS

C-6. CBRN defense planning and analysis assists the commander and staff in visualizing and assessing the full spectrum of adversary offensive CBRN weapons capabilities across the AO. Commanders, with staff input, assess their units' vulnerability to CBRN attacks. Commanders determine the unit protection required to counteract enemy capability. They estimate the likely impact of CBRN attacks, and based on the CONOPS, determine methods of reducing the impact to allow mission accomplishment. This includes planning decontamination operations to mitigate the effects of a CBRN attack. The following should be considered when planning CBRN defense:

- **Intelligence collection, analysis, and production.** Assessments should identify threat agents and weapons and industrial sites containing TIM that would present a hazard to deployed forces if sabotaged or destroyed.
- **SA.** CBRNWRS should be activated as quickly as possible after entry into a theater. Systems (Biological Integrated Detection System) should be deployed to monitor high-value assets. Detection systems for CBRN agents should be deployed and networked to provide a warning of attack.
- **Common planning, training, and equipment standards.** Gaps in the CBRN defense capabilities of multinational forces are identified to promote effectiveness in planning and operations.
- **Medical CBRN defense.** Medical CBRN defense is integrated into the planning process to support unit readiness.
- **Protection of the joint security area and theater sustainment capabilities.** A successful adversary CBRN attack on an essential port of debarkation or other critical logistics facility can degrade joint force operating tempo and force generation capabilities.
- **Logistics burden of CBRN attacks.** The resupply of protective clothing, equipment, repair parts, medical supplies (antidotes and antibiotics), and other resources must be factored into the computation of resource requirements.
- **In-theater active defense systems.** Planners should consider deployment configurations and CONOPS that maximize the use of active defense systems.
- **Preplanning for attack operations.** Attack operations are prioritized and may be a high strategic or national priority at any point in a crisis, during the transition to war, or during hostilities as a means to deny an adversary the capability to produce, store, transport, or employ CBRN weapons.
- **Effects of CBRN attacks on information and communication systems.** Limitations will result from the requirement to operate in CBRN protective equipment, from the effects of electromagnetic pulse on electrical and electronic equipment to the contamination of equipment.
- **Capabilities and limitations of multinational forces.** The planning process should consider the implications and feasibility of diverting U.S. assets and capabilities to support HNs and other multinational members in meeting common operational objectives.
- **In-theater consequence.** Plans for in-theater consequence include the mitigation and management of the effects of CBRN attacks within a theater of operations. (See *Multiservice Tactics, Techniques, and Procedures for Chemical, Biological, Radiological, and Nuclear Consequence Management Operation*.)

## OPERATIONAL IMPLICATIONS

C-7. At the operational level, the analysis of the OE should concentrate on—

- The capability of transportation networks to support movement.
- Logistics support to CBRN weapons.
- Zones of entry into and through the operational area and AOI.
- The impact of large geographic features (mountains, forests, deserts, archipelagos) on military operations.
- Seasonal climatic impacts on CBRN weapon effects.

## TACTICAL IMPLICATIONS

C-8. At the tactical level, the size and location of the AO are influenced by the physical location of adversary land, air, naval, and space that could pose a direct threat to the security of the friendly force or the success of its mission. The extent to which the effects of the OE are analyzed at the tactical level largely depends on the mission and planning time available. At a minimum, tactical-level forces should analyze the OE in terms of military objectives; avenues of approach; and the effects of a CBRN environment on personnel, military operations, weapons systems, and force mobility. CBRN defense at the tactical level will be based on, and result in, a higher degree of detail than would be necessary at higher levels of military operations.

## HOMELAND DEFENSE IMPLICATIONS

C-9. A challenge for commanders conducting consequence operations is the requirement to adequately protect personnel and materiel from a CBRN incident. There is a need for a response capability to save lives, contain an incident, and recover to a point that permits operations to resume. Confronting this challenge requires a comprehensive and integrated approach—from threat mitigation to incident response and recovery. Military units develop deliberate plans to respond to CBRN attacks within their assigned regions. Response plans should be updated regularly and coordinated with the appropriate response agencies in the region. Plans should focus on unanticipated events and potential terrorist targets (special events, high-profile buildings, medical and scientific research centers, air and rail transportation platforms). Response elements should also prioritize planning efforts in coordination with the other response agencies within their region. Planning efforts should be prioritized based on the most likely threats.

## CHEMICAL DEFENSE PLANNING CONSIDERATIONS

C-10. When conducting chemical defense planning, operational, tactical, and homeland defense implications must be considered.

## OPERATIONAL IMPLICATIONS

C-11. Chemical warfare can be used to contaminate the ground and resources with persistent chemical hazards. Nonpersistent vapor hazards and the vapor from persistent contamination can spread downwind and pose a hazard over a significant portion of the AO, given the right meteorological conditions. Commanders need to consider the avoidance and evacuation of hazard areas. Chemical warfare protection will be needed for forces that remain in the area. Operational capability and tempo are likely to be degraded because of the need for the force to adopt CBRN defense detection, warning, protection, and control measures. Chemical detection, identification, protection, and decontamination will put a burden on the theater logistics system.

## TACTICAL IMPLICATIONS

C-12. Forces remaining in or near chemical warfare hazard areas will probably need to remain in CBRN protection until the commander determines that personnel should reduce their MOPP level. This may decrease operating tempo because it may—

- Cause personnel to work in individual protective equipment, degrading performance, increasing fatigue, and possibly lowering force cohesion and morale.
- Reduce the overall speed, cohesion, and freedom of movement of forces in the local area because of contaminated areas and assets.
- Restrict the local use of ground and operational assets, cause resource-intensive decontamination of key assets, and distort the logistics chain.

## HOMELAND DEFENSE IMPLICATIONS

C-13. The use of chemical agents can cause psychological and physiological effects and contamination or damage that will restrict the use of facilities, equipment, or supplies. Fear and panic are normal reactions to discussions of chemical agents, and most civilian authorities will need considerable assistance in locating, containing, and recovering from a chemical incident.

## BIOLOGICAL DEFENSE PLANNING CONSIDERATIONS

C-14. The potential impact of biological warfare attacks at the operational level can be wide-ranging and significant, particularly if the detection and identification of an attack proves difficult and countermeasures are hard to implement. Large numbers of casualties can reduce the operational capability of the joint force, reduce morale, and divert medical and logistics resources from current operations. When combined, these factors may reduce operating tempo.

C-15. There will be some loss of operational capability by those forces remaining in or near biological warfare hazard areas. The following factors may hinder personnel effectiveness:

- Remaining in CBRN protection for long periods of time.
- Maintaining frequent and regular health monitoring of personnel, increased standards of hygiene, and protection of rations and water.
- Avoiding the use of contaminated areas and assets.
- Decontaminating key assets.

C-16. The inherent danger of biological warfare is amplified by the fact that exposure to the agents would probably not be known until symptoms appear (sentinel casualty). Personal protection generally consists of individual protection and medical measures (immunization, the application of postincident medical treatment [antibiotics]). Biological-agent dissemination could be accomplished by aerosol dissemination, food or water contamination, or vector release. Biological-agents can be produced in the laboratory or purchased from a number of medical research firms. For planning purposes, individual protection at a suspected biological incident is of the utmost importance. Mobile laboratories can process samples and identify pathogens. Early identification is essential to begin treatment protocols.

## NUCLEAR DEFENSE PLANNING CONSIDERATIONS

C-17. The devastation resulting from a nuclear burst will likely require that a significant portion of the joint force assets be deployed to assist in recovery in the area. The fallout from the nuclear detonation will cover a portion of the joint operations area, and measures to control the contamination and exposure of personnel in the area will be needed. The operational capability of the joint force is likely to be degraded for a considerable period. The potential for mass casualties in the local civilian population is also likely to place a burden on the operational command and staff.

C-18. In the area of a nuclear detonation, the operational capability of the joint force will be seriously degraded. Degradation will be caused by the loss of personnel, equipment, and resources. The need to rescue and treat injured personnel and possibly fight fires will require a significant expenditure of resources. The blockage of transportation routes and mobility corridors by debris and trees may degrade recovery. There will also be a need to deploy assets to assist other agencies and/or the HN. The immediate area of the nuclear detonation is likely to be highly contaminated, and movement, except to save lives, will be severely limited. Fallout and induced radiation patterns will require that units follow the prescribed operational exposure guide.

C-19. While the detonation of a nuclear device is perhaps the least likely scenario for a terrorist incident, it has the potential to cause the greatest damage in terms of destruction and psychological impact (fear and panic). The effects of a nuclear detonation include thermal, blast, and nuclear radiation. Even for a small nuclear device, the number of casualties from blast, thermal, and initial nuclear radiation could number in the hundreds. The presence of an induced radiation pattern and downwind fallout will require a large number of monitors using radiac equipment and might require the evacuation of a large number of people until the radiation decays to a safe level.



## RADIOLOGICAL WEAPONS DEFENSE PLANNING CONSIDERATIONS

C-20. Radiological warfare can be used to contaminate ground and resources with radioactive hazards. Commanders will need to consider the avoidance and evacuation of the hazard areas, particularly in stability operations and civil support operations. Radiological protection will be needed for forces that remain in the area. Operational capability and tempo are likely to be degraded because of the need for the joint force to adopt CBRN defense detection, warning, protection, and control measures.

C-21. There will be some loss of operational capability by those forces remaining in or near radiological hazard areas. This will be caused by the need to—

- Remain in CBRN protection for long periods of time.
- Manage exposure to radioactive hazards and rotate personnel, particularly during support operations.
- Avoid the use of contaminated routes, areas, and assets.
- Decontaminate key assets.

C-22. There are two potential scenarios for the use of radiological weapons:

- **Improvised explosive device.** A terrorist could wrap an improvised explosive device with radiological materials to create an incident in which the initial explosion may kill or injure persons in the immediate vicinity of the device. Following the incident, the possible ingestion and inhalation of radioactive particles would pose a health risk to responders and others remaining in the area.
- **Simple dispersal.** Simple radiological dispersal is an act intended to spread radioactive material without using an explosive device. A terrorist need only secure a supply of radiological material (gamma, beta, alpha emitters) from a medical laboratory, industrial facility, or other site and disperse the material.

## ACCIDENTAL-RELEASE AND TOXIC INDUSTRIAL MATERIAL DEFENSE PLANNING CONSIDERATIONS

C-23. The locations of significant TIM facilities in the joint operations area need to be plotted and avoided during operations whenever and wherever possible. Contingency plans need to be coordinated with the HN to control and contain the hazards if TIM facilities are damaged. Whatever the circumstances of a TIM release, the impact on military capability will need to be assessed. A large-scale release from a TIM facility, particularly if accompanied by large fires, has the potential to spread toxic aerosols and obscuration across a significant percentage of the operational area. Such hazards will need to be avoided by the joint force or protection will be needed, particularly during support operations. This is likely to restrict the freedom of action of the joint force and may degrade operating tempo. Damage to nuclear facilities, even without a breach to core containment, may also spread radioactive aerosols and obscuration. In addition, if threat CBRN weapon production or storage sites are targeted and hit, downwind hazard prediction should be accomplished to determine if there is a threat to U.S. forces or HN personnel.

C-24. Forces that remain in the area will probably need to adopt protection. Because of the nature of the TIM, countermeasures may not exist within the CBRN defense capability of the joint force. In this case, a specialist in the field of hazardous materials management will be needed from the HN or outside the theater. If conflict takes place in the area of TIM storage facilities, the risk of collateral damage and the release of TIM must be assessed. Unused industrial sites with hardstands and warehouses often provide ideal logistics facilities, but need to be checked for forms of TIM before use. Particular note of TIM needs to be taken when selecting accommodations for personnel.

C-25. TIMs are substances that may create signs and symptoms similar to CBRN exposure. These materials are found throughout the normal transaction of daily business in the United States and are transported on our railways, roadways, and waterways. They may or may not be precursors to CBRN agents. Most of the materials contain volatile organic compounds, which are materials that contain hydrocarbons and possibly other hazardous elements. They may be naturally occurring or man-made and may evaporate easily based on agent characteristics. Testing has proven that extended exposure may lead to debilitating injury. Some

are carcinogenic (benzene) or mutagenic (hexane, causing a nervous system disorder). Technological innovations and the widening proliferation of CBRN hardware and scientific expertise increase the likelihood that states, nonstate actors, or transnational groups could threaten the U.S. homeland and population directly and, in times of conflict, deny U.S. access to critical overseas and domestic infrastructures. Terrorism remains one of the deadliest and most persistent threats to U.S. security. The motives and methods of terrorist groups are evolving in ways that complicate analysis, collection, and counteraction and require the ability to respond flexibly and quickly. Sophisticated detection and analytical equipment is required to detect and identify the TIM, and special protective equipment may be needed.

## MEDICAL PLANNING CONSIDERATIONS

C-26. The medical planner is responsible for developing and identifying medical countermeasures, coordinating HSS, and conducting integrated assessments of the risks posed by CBRN threats and hazards.

C-27. The operational and tactical planner should understand the capabilities and limitations of the medical assets when planning HSS throughout the theater of operations. Unless otherwise indicated, medical assets without collective protection will be unable to treat casualties in chemically contaminated environments and may suffer operational degradation in radiological or biological environments.

C-28. The HSS assessment is comprised of the following tasks:

- Determine the health threat/risk in the incident area, identify medical countermeasures, and recommend exposure guidelines/criteria for protection, unmasking, and decontamination decisions.
- Document exposures in individual medical records and in medical event reports, and submit the reports to the designated DOD exposure archive at the U.S. Army Center for Health Promotion and Preventive Medicine.
- Identify the population at risk in the incident area.
- Identify local health care facility capabilities.
- Determine DOD augmentation needs for mass casualties.
- Determine the types and numbers of medical units/personnel required to provide support at the incident location.

C-29. The CBRN staff should coordinate with the medical planner to prioritize the following key tasks:

- Determine the types and numbers of medical units/personnel required to provide support at the incident location.
- Establish detector and sensor systems as identified in base plans (accomplished by medical units, including medical treatment facilities). The systems should be established outside the medical treatment facilities to identify potential contamination before it enters the treatment facilities.
- Establish radiation detection capability to ensure that the deployed medical facility is equipped to detect radiation if the unit is deployed in a location where a nuclear/radiological threat is expected.
- Establish chemical detection and reporting capability for the medical units within medical areas or sectors.
- Establish CBRN sampling capability.
- Establish a confirmatory biological agent identification capability, to include chain-of-custody requirements.
- Initiate medical surveillance to support early biological-agent detection and disease and nonbattle injury reporting.
- Establish communication links with medical intelligence and CBRN reporting systems.
- Establish medical collective-protection capability where available.
- Establish patient decontamination capability.
- Determine the population at risk and CBRN casualty estimates.
- Tailor personnel and equipment to meet command-required capabilities.



- Ensure that appropriate deploying-unit CBRN training has occurred. Medical personnel must also complete additional medical-specific CBRN training.
- Ensure that medical personnel can don/doff individual protective equipment and conduct mission-essential tasks at appropriate MOPP levels.
- Identify CBRN-related shortfalls.

C-30. In planning for a CBRN incident, the planner must possess a variety of references and experience with the medical aspects of CBRN threats and hazards. In the planning stage, the CBRN staff officer, public health officer, and command surgeon work together with the public affairs officer to develop tools (press releases to communicate risks).

## KEY SUSTAINMENT PLANNING FACTORS

C-31. Adequate logistics planning is a key element in operations and requires planning for a continuous resupply of consumable and expendable items. Planning for the use of collective-protection systems is one example of a key sustainment requirement. Survival under CBRN conditions is not a question of merely maintaining special-purpose supplies; it is a matter of obtaining needed quantities of existing supplies. Plan for the needed supplies, and stockpile them before an attack.

C-32. As a minimum, these supplies should include protective clothing, expedient contamination avoidance items, decontamination kits, detector kits, and filters. Provide adequate food and water if the warfighter will operate for long periods within the contaminated area. If the equipment requires fuel, ensure that it is requisitioned and stored.

## PLANS AND ORDERS

C-33. Commanders direct operations and synchronize the warfighting functions through plans and orders. Commanders use factors (METT-T, METT-TC) to assess the CBRN situation. Collaborative information sharing and staff estimates help commanders refine and deepen their situational understanding of the OE. Commanders then visualize the operation, describe it within their intent, and direct their subordinates toward mission accomplishment.

## MISSION RECEIPT

C-34. The planning process begins with receiving or anticipating a new mission. This mission can come from an order issued by higher headquarters or be derived from an ongoing operation. For example, the commander may determine—based on a change in enemy dispositions, friendly force dispositions, or other battlefield factors—that there is an opportunity to accomplish the higher commander’s intent by a means different from the original CONOPS. (See figure C-1 for more information on mission receipt.)

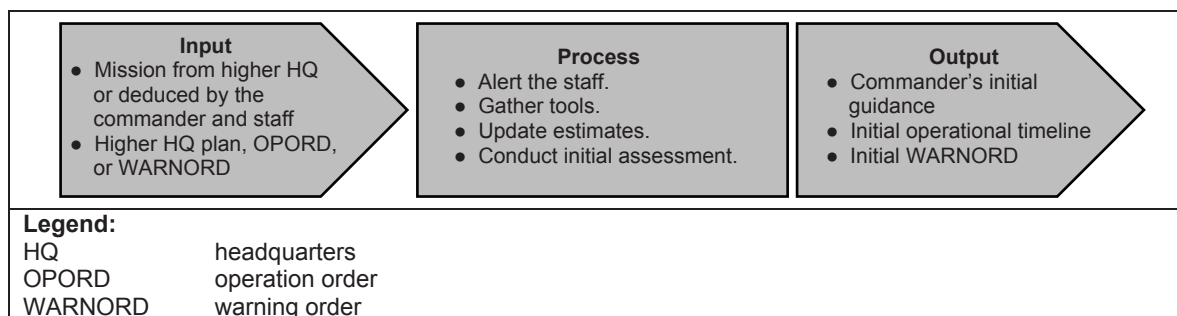

Figure C-1. Mission receipt

## MISSION ANALYSIS

C-35. Mission analysis is the most important step of the planning process. Mission analysis allows the commander and staff to visualize the battlefield—to see the troops, the enemy, and the terrain/environment. The goal of mission analysis is to develop SA that is relative to the mission. Along with conducting a staff

estimate, the CBRN staff begins developing the CBRN vulnerability analysis, MOPP analysis, CBRN threat status, CBRN vulnerability reduction and protection measures, employment status, and task organization of CBRN units and assets.

C-36. To help the commander analyze and restate the mission quickly, the CBRN staff begins analysis as soon as the order is received. The CBRN staff identifies constraints, restrictions, and specified and implied tasks contained in their portion of the order.

C-37. The commander or CBRN staff identifies the essential tasks, which define mission success, and includes them in the restated mission. The restated mission contains the elements of what, when, where, and why the unit will execute.

C-38. Mission analysis consists of multiple tasks, which are not necessarily sequential. This gives the CBRN staff a frame of reference to assess the commander’s work and develop their own visualization. (See figure C-2 for more information on mission analysis.)

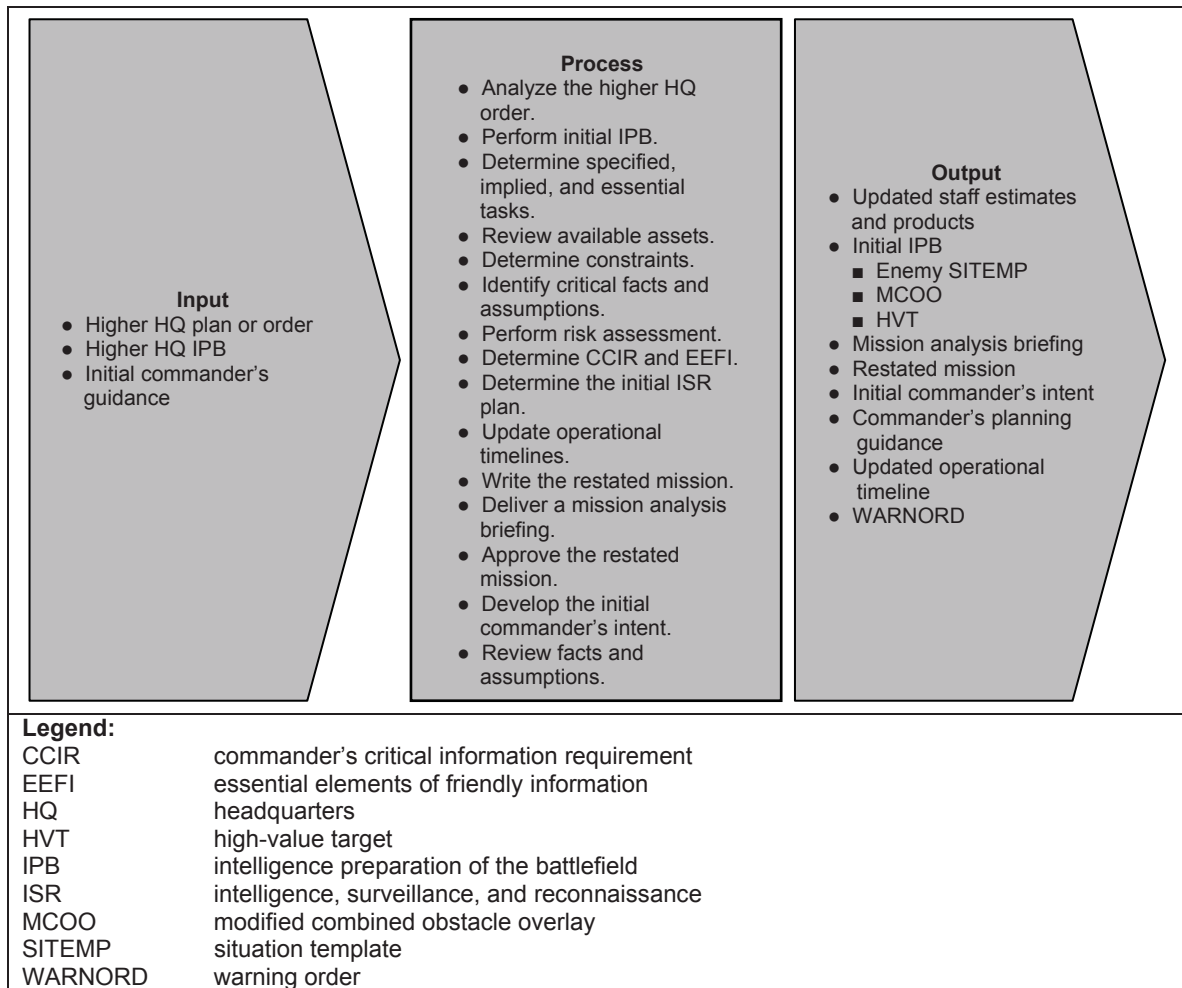

Figure C-2. Mission analysis

**COURSE-OF-ACTION DEVELOPMENT AND ANALYSIS**

C-39. COA development is the foundation of the CBRN defense plan. Effective COA development ensures that planning time is well spent and facets of relevant information are considered. COA analysis allows the staff to synchronize the warfighting function for each COA and identify the COA that best accomplishes the mission.

## MISSION ANALYSIS

C-40. Mission analysis comprises the following steps:

- Analyze the order from higher headquarters.
- Perform initial IPOE/IPB.
- Determine specified, implied, and essential tasks.
- Review available assets.
- Determine constraints.
- Identify critical facts and assumptions.
- Conduct risk assessment.
- Determine initial CCIRs.
- Determine the initial ISR plan.
- Update the operational timeline.
- Write the restated mission.
- Deliver a mission analysis briefing.
- Approve the restated mission.
- Develop the initial commander's intent.
- Issue the commander's guidance.
- Issue a warning order.
- Review facts and assumptions.

### ANALYZE THE ORDER FROM HIGHER HEADQUARTERS

C-41. The order from higher headquarters is thoroughly analyzed by the CBRN staff to completely understand the commander's intent, mission, and CONOPS (including the deception plan). The CBRN staff coordinates with higher headquarters regarding—

- Procedures for requesting CBRN assets.
- Estimated response time for CBRN support.
- C2 of assigned CBRN assets.
- Linkup points and procedures for CBRN assets.
- Locations of external decontamination assets throughout each phase of the battle.
- Requests for and use of HN support.

### PERFORM INITIAL INTELLIGENCE PREPARATION OF THE OPERATIONAL ENVIRONMENT/INTELLIGENCE PREPARATION OF THE BATTLEFIELD

C-42. IPOE/IPB is an integrated process completed by each member of the battle staff and normally coordinated with the intelligence staff officer. The CBRN staff officer contributes to each of the four steps of the IPOE/IPB process. The process is continuous, and many of the following steps and associated subelements may be performed simultaneously.

#### Step 1. Define the Operational Environment

C-43. The AO and AOI must first be identified. The AO for the supporting force is normally the same as that of the supported force. The CBRN AOI encompasses threat forces and systems that are capable of delivering CBRN into the AO. It also includes industrial and research facilities (TIMs). Next, an in-depth evaluation of the area is conducted to describe the OE. The CBRN staff officer addresses the following areas by answering key questions:

- **Threat forces and capabilities.** What types and ranges of CBRN agents does the threat force possess? Where are the threat CBRN defense forces and CBRN weapons and delivery systems? When can those systems affect the unit on the battlefield?
- **Population demographics.** Where are the densely populated areas?

- **Political/socioeconomic factors.** Do the threat forces have allies that might enhance their capabilities or trading partners that might sell weapons to them? Do the threat forces have a history of CBRN use?
- **Infrastructure.** Does the infrastructure network operate efficiently, or is it cumbersome? Are there industrial chemical plants or nuclear power facilities that may be targeted by threat forces? What is the civil response capability of hospitals, clinics, and medical treatment facilities to handle patients from a CBRN incident? Are facilities and water sources available to support decontamination operations?
- **Rules of engagement and legal restrictions.** Is the threat force a treaty or agreement signatory? Are there significant moral or religious sanctions for or against the use of CBRN weapons by the threat force?

## Step 2. Describe the Effects of the Operational Environment

C-44. The following tasks should be completed when describing the effects of the OE on military operations:

- **Determine the effects of CBRN agents.** The CBRN staff should determine how CBRN agents and obscurants affect threat and friendly operations.
- **Conduct terrain analysis.** The terrain should be analyzed to determine its military significance and predict its effect on CBRN operations. For example, terrain containing large forests tends to magnify the obstacle-producing effects of nuclear and chemical weapons, whereas defiles serve as likely employment areas for chemical weapons. Soil type, vegetation, and drainage should be described, and critical terrain features (defiles, choke points, rivers) should be identified. Water sources suitable for decontamination should be located. Mobility corridors and avenues of approach should be analyzed for areas that are vulnerable to CBRN weapons and areas that are especially suitable for the use of obscurants. The CBRN staff officer should answer the following questions:
  - What effect will the terrain have on CBRN weapons?
  - Where will the use of CBRN weapons cause the most problems for the operation?
  - What effects will CBRN agents have in open terrain? In heavily vegetated areas? In urban terrain?
  - Can/will enemy forces use CBRN weapons to cause populations to panic? To impede movement of attacking forces? To impose increased protective requirements on forces and civilian populations?
  - Will reduced sanitary conditions enhance the available growth medium for biological organisms, resulting in an increased probability that naturally occurring biological agents and vectors will pose elevated health risks to warfighters and civilians?
  - How many civilian laboratories and major industrial facilities are located in populated areas?
  - Where are critical terrain features (defiles, choke points, rivers, high ground) located?
  - To what degree does the terrain provide protection through cover and concealment?
  - Where are water sources and areas suitable for decontamination of equipment located?
- **Conduct weather analysis.** Detailed weather information must be obtained to determine its effects on the employment of CBRN weapons and materials. For example, thermometer readings are used to estimate the effect of temperature on agent duration; data regarding wind speed and direction is used for hazard and obscuration prediction; and information about atmospheric conditions (humidity, air stability) is useful to predict their influence on the use of obscurants. The CBRN staff should answer the following questions on weather analysis:
  - What effect will weather have on the employment of CBRN weapons?
  - How will weather affect the behavior of TIMs?
  - When will the weather be favorable or unfavorable for the use of CBRN weapons during the next 72 hours?

### Step 3. Evaluate the Threat

C-45. Threat force capabilities must be identified and doctrinal principles and TTP employed by the threat force. These factors, along with the specifics of the current situation, determine the CBRN threat condition. It is important that enemy unit type, composition, disposition, capabilities, and intent are well understood. An evaluation of the threat requires that the CBRN staff answer the following questions:

- What types of CBRN weapons, obscurants, and delivery means do the threat forces possess?
- What are the minimum and maximum ranges of the various threat force delivery systems?
- Where are the TIMs located, and how might the threat forces employ them?
- Where are the units that possess the delivery systems located, and where are their command posts and communications nodes?
- What types of CBRN protection and detection equipment does the threat force have?
- What type of CBRN protective posture does the threat force have?
- Is threat force CBRN weapon employment terrain-oriented, force-oriented, or a combination of both?
- What details are available regarding the previous use of CBRN weapons by the threat force—especially during recent operations?
- Are there probable employment indicators?
- Is the threat force willing and able to fight “dirty”? What is the intent of the threat force?

### Step 4. Determine Threat Courses of Action

C-46. The CBRN staff identifies likely objectives and predicts the desired end state of the threat force. During this phase, the information previously collected by the CBRN and intelligence staff officers is combined to identify possible enemy COAs. The full set of COAs for CBRN/obscurant employment available to the threat force is considered, and situation templates depicting probable target areas are created for each potential COA.

C-47. Tasks involved in the creation of a situation template can include identifying—

- Locations on the situation template where a terrain-oriented threat force may employ persistent chemical agents.
- Lines or decision points where a force-oriented threat force may employ chemical agents.
- Identify high-payoff targets based on information obtained from threat-force nuclear or biological employment doctrine.
- Heavily populated areas that could be targeted by the threat force.
- Major agricultural, bioresearch, or pesticide facilities that could be targeted by the threat force.
- Nuclear power plants and other facilities containing radiological sources that could be targeted by the threat force.

C-48. The CBRN and intelligence staff officers delineate areas on the situation templates where they suspect the threat force may employ CBRN weapons, and they indicate when that employment might occur.

C-49. Each potential COA is evaluated and prioritized based on information concerning likely areas of ground force penetration by forward lines, friendly assets that the threat force is likely to consider high for engagement by CBRN weapons, and existing contaminated areas that may indicate which COA was adopted by the threat force.

C-50. Following situation template development, additional information requirements should be identified. The CBRN staff determines specific areas and activities that, when observed, might reveal which COA the threat has selected. These become NAIs. Templated CBRN events become NAIs and are placed on the situation template for each COA. The situation templates for each enemy COA are then collated; and the differences between NAIs, indicators, and time phase lines form the basis of the event template. Information requirements that require gaining information about the enemy are designated as NAIs. Consider using obscurants to protect infrared systems.

C-51. Once completed, the CBRN IPOE/IPB provides the foundation for—

- Vulnerability analysis.
- Automatic masking criteria.
- CBRN threat status.
- MOPP analysis.
- CBRN protective measures.
- CBRN asset employment.
- Task organization.

### DETERMINE SPECIFIED, IMPLIED, AND ESSENTIAL TASKS

C-52. Specified CBRN tasks are those tasks assigned by higher headquarters. Examples of specified tasks include providing obscuration in support of a deception plan or providing a list of decontamination sites to higher headquarters for approval. Specified tasks can be found in the base plan, annexes, and overlays. Additionally, the commander may direct a specified task while issuing guidance.

C-53. Implied CBRN tasks are those tasks that—although not stated in the order—must be accomplished to carry out a specified task. Implied tasks can be determined by analyzing doctrinal considerations that are necessary to perform a specified task. Implied tasks can also be derived by analyzing the current location of the unit in relation to the area where the specified task is likely to be performed. Only those implied tasks that require allocation of CBRN resources should be kept. Coordinating for water support to conduct decontamination operations is an example of this type of task.

C-54. Essential CBRN tasks are those tasks that must be executed to accomplish the mission. Essential tasks drive the planning and allocation of assets. An example of an essential task is locating a bypass route for a vehicle to allow freedom of maneuver along an axis.

### REVIEW AVAILABLE ASSETS

C-55. The CBRN staff must determine what CBRN units and assets are available, including estimated supplies required to accomplish specified and implied tasks. They identify command and support relationships—organic, assigned, and attached. If insufficient assets are available to accomplish specified and implied tasks, alternative methods may be developed, additional assets may be requested, or the risk associated with failure to complete certain tasks may be determined. The CBRN staff must be prepared to provide the commander or operations staff officer with a description of the units, assets, and capabilities available for the mission.

### DETERMINE CONSTRAINTS

C-56. Higher headquarters normally places some constraints on subordinate units. Other constraints may take the form of a requirement or a prohibition to do something. Insufficient resources should be determined during the review of available assets; however the lack of resources is not necessarily a constraint.

### IDENTIFY CRITICAL FACTS AND ASSUMPTIONS

C-57. It is important to identify the following information as it relates to known CBRN intelligence indicators and enemy doctrine:

- **Facts.** Facts are statements containing known data about a situation, including enemy and friendly dispositions, unit strengths, and material readiness.
- **Assumptions.** Assumptions are suppositions assumed to be true in the absence of facts.



## **CONDUCT RISK ASSESSMENT**

C-58. The commander and staff identify accident risks. The commander also makes an initial assessment of where he/she might accept tactical risk. The CBRN staff updates the vulnerability and MOPP analyses and advises the commander about accidental risk associated with the plan, tactical risks pertaining to CBRN defense and obscurants, and the risks of CBRN attacks and hazards.

## **DETERMINE THE INITIAL COMMANDER'S CRITICAL INFORMATION REQUIREMENTS**

C-59. CCIR identify information that the commander needs to support his/her battlefield visualization and to make critical decisions—especially to determine or validate COAs. CCIRs, which should be limited to 10 items or less, consist of two types: priority intelligence requirements and essential elements of friendly information.

## **DETERMINE THE INITIAL INTELLIGENCE, SURVEILLANCE, AND RECONNAISSANCE PLAN**

C-60. CBRN-templated areas of possible contamination that could affect operations are designated as NAIs. An NAI may be a specific point, route, terrorist target, industrial facility, or, in the case of a templated chemical strike, an area. The CBRN staff ensures that templated CBRN events become NAIs and are placed on the situation template for each COA. NAIs and other gaps in intelligence are addressed in a collection plan, in which responsibility for collecting information is assigned. Initial collection requirements are subsequently modified following the analysis of specific areas and activities that are expected to reveal the COA selected by the threat force.

## **UPDATE OPERATIONAL TIMELINE**

C-61. The commander and staff refine the initial timeline. They compare the time needed to accomplish essential tasks to the time allocated by higher headquarters. They also compare their timeline to the enemy timeline developed during the IPOE/IPB.

## **WRITE THE RESTATED MISSION**

C-62. The CBRN staff writes a restated CBRN mission directed at the CBRN assets assigned.

## **DELIVER A MISSION ANALYSIS BRIEFING**

C-63. The CBRN staff must know the status of subordinate and supporting units, and they must conduct a mission analysis briefing to relay relevant information. The unit SOP usually specifies the structure of the briefing.

## **APPROVE THE RESTATED MISSION**

C-64. Immediately after the mission analysis briefing, the commander approves a restated mission. This may be the restated mission recommended by the staff, a modified version of the staff recommendation, or a mission that the commander has developed. Once approved, the restated mission becomes the unit mission.

## **DEVELOP THE INITIAL COMMANDER'S INTENT**

C-65. Normally, the commander develops his/her intent during the mission analysis; he/she may modify that intent after the mission analysis briefing, if necessary. The commander's intent is a clear, concise statement of what the force must do with respect to the enemy and terrain to achieve the desired end state.

## **ISSUE THE COMMANDER'S GUIDANCE**

C-66. The CBRN staff may recommend that particular items be included in the commander's guidance. The guidance, once issued, directs the CBRN staff on the use of obscurants, reconnaissance, decontamination, MOPP, and other aspects of CBRN defense and obscuration operations.



## ISSUE A WARNING ORDER

C-67. Examples of CBRN staff input to a warning order include—

- CBRN reconnaissance initiated (Fox and Biological Integrated Detection System).
- CBRN priorities and timelines.

## REVIEW FACTS AND ASSUMPTIONS

C-68. Because mission analysis is a continuous process, the CBRN staff officer must review the CBRN facts and assumptions to determine whether anything has changed. Whenever facts or assumptions change, the commander and staff must assess the impact of these changes on the plan and make the necessary adjustments.

## COURSE-OF-ACTION DEVELOPMENT

C-69. It is difficult to develop COAs that are complete, feasible, unique, consistent with doctrine, and in compliance with the commander's guidance based on the results of the mission analysis. The CBRN staff fully participates in this process to ensure that CBRN defense and obscurant operations are properly integrated and synchronized with the tactical plan.

C-70. Tasks performed by the CBRN staff during COA development include the following:

- Continue to refine the CBRN threat, providing input to one or more of the following intelligence staff products:
  - Situation template.
  - Event template.
  - Reconnaissance and surveillance plan.
  - Priority intelligence requirements.
- Develop a tentative plan for the integration of obscuration, decontamination, reconnaissance, and flame field-expedient assets that supports the developing COA scheme of maneuver.
- Complete the task organization of CBRN assets for each COA.
- Develop a unit vulnerability assessment. (See appendix B for vulnerability assessments.)
- Analyze the synchronization feasibility of artillery, mechanized, and potted obscuration units in support of each COA.
- Locate operational/thorough decontamination sites that support the scheme of maneuver throughout the depth of the AO.
- Develop a tentative plan for the movement of chemical defense equipment/protection equipment from combat trains to forward unit locations—particularly for light forces.
- Make recommendations, based on the commander's guidance, for automatic masking criteria and FP measures, balancing the level of protection against the threat.
- Develop a tentative CBRN casualty management plan.
- Develop branch plans for avoidance. Based on a bypass decision by the commander, describe changes that will take place to the scheme of maneuver if confronted with contamination.
- Determine risk factors due to crossing contamination.

C-71. After developing COAs, the staff may conduct a COA briefing. The optional COA briefing provides the CBRN staff with an opportunity to ensure that they followed the commander's guidance correctly in developing COAs. A collaborative session facilitates the planning process by ensuring that the CBRN staff does not enter the war game or invest a lot of time and intellectual energy into a COA or multiple COAs that do not follow the commander's intent.

C-72. After the briefing, the commander may give additional guidance. If COAs are rejected, the CBRN staff begins again. If one or more of the COAs are accepted, CBRN staff members begin COA analysis. The commander may create a new COA by incorporating elements of one or more COAs developed by the staff. The CBRN staff then prepares to war-game this new COA.

## COURSE-OF-ACTION ANALYSIS (WAR GAMING)

C-73. Following COA development, the CBRN staff analyzes each COA. The analysis consists of feasibility checks, war gaming, risk assessment, and comparisons of war-game results. War gaming results in the identification of tasks, combat power requirements, critical events, priority efforts, task organization, command and support relationships, decision points, and possible fratricide locations. The CBRN officer, along with the rest of the staff, assists in war-gaming each COA against the anticipated enemy action or reaction. The CBRN staff should be prepared to provide the following input, knowledge, or information during the war-gaming session:

- CBRN threat integration for each enemy COA.
- Available CBRN assets and an explanation of how they might be used to support each friendly COA.
- Unit vulnerability assessment.

C-74. COA analysis assists the CBRN officer in completing the following actions and answering associated questions.

C-75. Anticipate critical CBRN events/actions, and conduct vulnerability assessments, including probable targets and agent effects. Ask the following:

- Will concentrated friendly forces present a target whose contamination or destruction is worth the enemy expense of CBRN weapons?
- Are friendly forces located close to an industrial facility that could be a hazard?
- Does the enemy have time to locate, analyze, and attack before friendly forces can be displaced or dispersed?
- Will friendly forces be moving at such a rate of speed that the enemy cannot hit them?
- Will friendly forces be so close to enemy troops that the enemy will be required to violate doctrinal constraints to attack—or even contaminate themselves?
- What type of CBRN munitions (if nuclear, with what yield) will the enemy use to attack?
- What types of industrial compounds/substances are present at industrial facilities in the AO?
- Will the enemy use of chemical or nuclear weapons restrict maneuverability?
- Have possible chemical attack locations or possible industrial/chemical facility locations been identified during the action-reaction-counteraction phase of war gaming?

C-76. Consider the initial deployment and focus of reconnaissance, decontamination, obscuration, and biological units. Produce a tentative CBRN defense overlay, to include unit employment and a concept for their use. Perform the following:

- Assign reconnaissance assets or subordinate units with reconnaissance elements to perform the reconnaissance of suspected chemical, biological, or radiological weapons/container locations and/or industrial facilities in the AO.
- Assign CBRN reconnaissance and biological units to cover critical CBRN-related NAIs identified during the war-gaming process.
- Assign CBRN reconnaissance units to monitor known civilian chemical/industrial hazards for possible damage that can affect friendly operations. Consider detection and protection capabilities.
- Assign decontamination assets or subordinate units with decontamination elements to perform the reconnaissance of possible water sites and decontamination locations in the AO.
- Assign decontamination units to plan decontamination operations in areas where chemical contamination may occur as a result of an enemy attack or contamination from an industrial/chemical facility.
- Coordinate with the fire support officer on obscurant missions to cover potential obscuration targets identified during the war-gaming process (suspected enemy observation points, river-crossing operations, deception operations).
- Tentatively develop the concept for CBRN support, and determine the critical CBRN priorities and tasks for subordinate units.

- Tentatively determine CBRN task organization and command/support relationships.
- Integrate the CBRN collection plan into the intelligence collection plan.
- Recommend the MOPP level and provide operational exposure guidance that is consistent with mission accomplishment.
- Recommend locations for CBRN units and the headquarters command post.

C-77. COA analysis (war gaming) is a disciplined process. It includes rules and steps that help commanders and staffs visualize the flow of an operation. The process considers friendly CBRN dispositions, strengths, and weaknesses; enemy CBRN assets and probable COAs; and characteristics of the AO. It relies heavily on an understanding of CBRN doctrine, tactical judgment, and experience. War gaming focuses CBRN staff attention on each phase of the operation in a logical sequence. It is an iterative process of action, reaction, and counteraction.

### WAR-GAME BRIEFING (OPTIONAL)

C-78. Time permitting, the CBRN staff delivers a briefing to ensure that everyone understands the results of the war game. This briefing is normally not given to the commander. The CBRN staff uses it for review and ensures that relevant points of the war game are captured for presentation to the commander in the COA decision briefing.

### COURSE-OF-ACTION COMPARISON AND APPROVAL

C-79. The CBRN staff considers the characteristics of CBRN planning, the principles of CBRN, and the commander’s guidance in analyzing and evaluating the COAs. The staff compares the COAs, determining the advantages and disadvantages of each. Based on the analysis and comparison, the staff presents recommendations and then briefs the commander. The commander may select a COA, select a modified COA, or reject the COAs—in which case the staff begins the process once again. (See figure C-3 for more information on all COA comparison.)

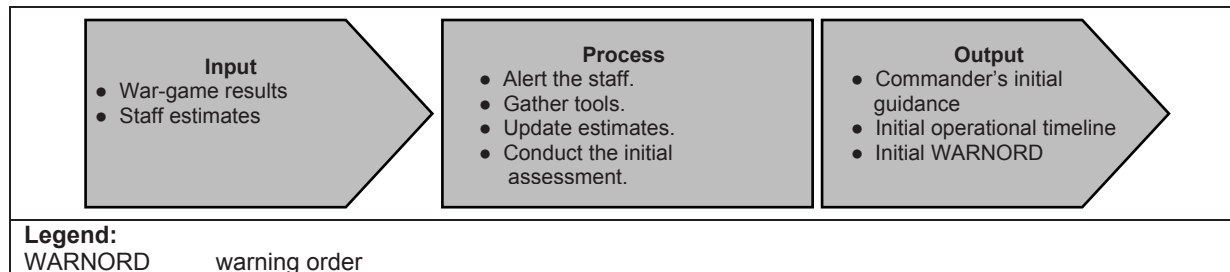

Figure C-3. COA comparison

C-80. The CBRN staff must compare COAs correctly to provide viable recommendations to the commander. Detailed analysis during comparison may identify a COA that satisfies the criteria better than one the staff believed was best.

C-81. The actual comparison of COAs is critical. The CBRN staff may use a technique that facilitates reaching the best recommendation and helps the commander to make the best decision. The most common technique is the decision matrix, which uses evaluation criteria to assess the effectiveness and efficiency of each COA.

### ORDERS DEVELOPMENT/PRODUCTION

C-82. The CBRN staff produces a CBRN annex and provides input to the base order. (See figure C-4 for a sample annex.)

<b>[Classification]</b>	
<p><b>ANNEX (CBRN Operations)</b>  <b>OPERATION ORDER No</b> [code name] [issuing HQ]</p> <p><b>1. SITUATION.</b></p> <ul style="list-style-type: none"> <li>a. Enemy situation. Address CBRN threat, including OBS, flame, and RCA.</li> <li>b. Friendly situation.</li> <li>c. Environment. In separate subparagraphs list all critical terrain, weather, and civil considerations that would impact CBRN operations. Refer to appropriate annexes as required.</li> <li>d. Attachments and detachments.</li> </ul> <p><b>2. MISSION.</b> State the CBRN mission in support of this operation.</p> <p><b>3. EXECUTION.</b></p> <ul style="list-style-type: none"> <li>a. Scheme of CBRN operations. Briefly state the CBRNE operation to be carried out. State OBS synchronization plan.</li> <li>b. Tasks to subordinate units. Include subordinate and supporting chemical unit tasks, missions, and priorities for CBRN reconnaissance, surveillance, and decontamination operations.</li> <li>c. Coordinating instructions. Address— <ul style="list-style-type: none"> <li>• MOPP level guidance.</li> <li>• Automatic masking criteria.</li> <li>• Troop safety criteria.</li> <li>• Link up points for decontamination sites.</li> <li>• Locations of medical facilities conducting patient decontamination and the treatment of CBRN-contaminated casualties.</li> <li>• Nonmedical Soldier support requirements for conducting patient decontamination under medical supervision.</li> <li>• Turn-in points and procedures for handling CB samples.</li> <li>• Civilian and military facilities whose destruction could create militarily significant CBRN hazards.</li> <li>• OEG (if applicable).</li> <li>• Procedures for limiting electromagnetic pulse effects.</li> <li>• Identification of designated observer units.</li> <li>• Identification of procedures for providing support to local populations.</li> </ul> </li> </ul> <p><b>4. SERVICE SUPPORT.</b></p> <ul style="list-style-type: none"> <li>a. Procedures for handling contaminated casualties and processing remains, if not in SOP.</li> <li>b. Information on the availability and location of field-expedient decontamination supplies, materials, and decontaminants.</li> <li>c. Information on the availability, procedures for distributing, prestock points, and transportation of CBRN and chemical defense equipment.</li> <li>d. Procedures for chemical defense equipment push-package concept.</li> </ul> <p><b>5. COMMAND AND SIGNAL.</b></p> <ul style="list-style-type: none"> <li>a. Command. Locations of chemical staffs and subordinate and supporting chemical unit HQ.</li> <li>b. Signal. <ul style="list-style-type: none"> <li>• Special signal instructions to subordinate and supporting chemical units.</li> <li>• Information concerning the CBRNWRS.</li> <li>• Information concerning the dissemination of strike warning messages.</li> </ul> </li> </ul> <p><b>ACKNOWLEDGE</b> (if distributed separately from base order)</p> <p>[Authenticator's last name] [Authenticator's rank]</p> <p><b>DISTRIBUTION</b> (if distributed separately from base order)</p>	
<b>[Classification]</b>	
<b>Legend:</b>	<ul style="list-style-type: none"> <li>CB                    chemical and biological</li> <li>HQ                    headquarters</li> <li>SOP                    standing operating procedure</li> <li>RCA                    riot control agent</li> <li>CBRN                    chemical, biological, radiological, and nuclear</li> <li>CBRNE                    chemical, biological, radiological, nuclear, and high-yield explosives</li> <li>CBRNWRS                    chemical, biological, radiological, and nuclear warning and reporting system</li> <li>MOPP                    mission-oriented protective posture</li> <li>OEG                    operational exposure guidance</li> </ul>

**Figure C-4. Sample CBRN annex**

C-83. The annex may be issued in the standard format or in the form of a matrix. The USAF and USN have standing orders for operations in a CBRN environment. The USMC and USA have COAs and end-state written orders. (See table C-1 for a comparison of the MCPP and MDMP.)

**Table C-1. Process comparison**

<i>MCP</i>	<i>MDMP</i>
Mission analysis	Receipt of mission
	Mission analysis
COA development	COA development
COA war game	COA analysis
COA comparison/decision	COA comparison
	COA approval
Orders development	Orders production
Transition	
<b>Legend:</b> COA                    course of action MCP                    Marine Corps planning process MDMP                  military decisionmaking process	

## Appendix D

# Threat Assessments

The CBRN threat assessment is an analysis of the likelihood that tactical units will confront CBRN threats and hazards. Consequently, CBRN threat assessments need to address avoidance, protection, and decontamination functions within a command AO and across the AOI. A deliberate adversarial CBRN threat is the possibility that some individual, state, or organization will attempt to harm U.S. military personnel or contaminate U.S. property through purposeful, often life-threatening action. Many CBRN hazards, however, originate from technological or natural disasters. The CBRN threat assessment must address potential threats and hazards.

### THREATS AND HAZARDS

D-1. Commanders and CBRN staffs must be prepared to go into any AO and perform their full range of missions while dealing with a wide range of CBRN threats and hazards, each with unique characteristics that could threaten the force. While conducting missions, military personnel may be at risk for exposure to the intentional use of CBRN weapons, the intentional or accidental release of TIM, or many environmental biological and radiological hazards.

D-2. CBRN weapons and materials present different implications. CBRN threats are intentional and include enemy actions using CBRN weapons and accidents involving exposure to TIM. Assessments must include the impacts of weather and environmental conditions, including the potential for natural disasters, and the current level of health and sanitation in the AO. (See *Potential Military Chemical/Biological Agents and Compounds* and FM 4-02.7.)

D-3. Potential CBRN hazards include, but are not limited to, chemical agents, biological agents, and radiological material that can cause death, serious bodily injury, or disfigurement. Hazards of concern include high and low levels of chemical warfare agents in air, soil, and water and are usually the result of an accidental release. To reduce vulnerabilities to CBRN hazards, commanders and CBRN staffs must continually assess the long- and short-range risks and the amount and manner of exposure that may produce such risks to identify prevention and mitigation strategies.

### DELIBERATE-ADVERSARIAL THREAT ASSESSMENT

D-4. The assessment of a deliberate-adversarial CBRN threat addresses three primary components: capability, opportunity, and intent. Capability is defined as the adversary's capability to carry out a specific type of threat activity based on their ability to design, develop, or deliver the resources (weapon systems) used in that activity. The staff examines available intelligence on potential CBRN hazards, weapons systems, storage facilities, production facilities, research and development programs, and delivery methods. The assessment of an adversary's capability involves several factors that require more specific information and will require ISR planning. An adversary capability assessment should address the following:

- **Who.** Type of adversary possessing CBRN weapons.
- **What.** Type of CBRN use.
- **When.** Timing for use in crises and conflicts.
- **Where.** Types and locations of targets.
- **Why.** Broad objectives for the use of CBRN weapons.
- **How.** Concept for CBRN employment.

D-5. Opportunity is defined as the adversary's opportunity to carry out an attack in relation to particular targets and the type of weapons or systems required to be effective against a target. The commander and CBRN staff assess factors (when, where, and how an adversary may use a CBRN weapon or agent).

Planners consider the weather, terrain, operational boundaries, defensive posture, and other factors to assess when or where an adversary may attack. An adversary may attack by—

- **Overt means.** Overt means include the application of overt systems (aircraft, cruise missiles, unmanned aircraft systems/remotely piloted vehicles, tactical ballistic missiles, small boats) against operational-level targets.
- **Covert releases.** Covert releases include, but are not limited to, various improvised CBRN devices or contamination of resources (drinking water).

D-6. Intent is defined as adversary goals, purpose, or aims, including the decisions required and means to achieve those goals, in terms of desired targets and effects. Commanders and CBRN staff conduct an assessment of adversary intent to use CBRN weapons. Adversary intent may be to cause casualties, contamination, degradation, or panic or to demonstrate its ability to attack anywhere, at any time.

## ACCIDENT OR NATURAL-DISASTER THREAT ASSESSMENT

D-7. Major accidents and natural disasters occur on a continuing basis and may involve CBRN agents or materials. A tactical unit should conduct direct observation to obtain information on the industrialization in their AO or gather intelligence on other hazards within the AOI. For example, a vast array of toxic industrial facilities may exist in or near the AO.

## IMPACT ASSESSMENT

D-8. Planners assess the impact of a CBRN attack or incident on the AOR. Attack templates identify whether the attack is conducted on or off the installation. Attack scenarios could include point source attacks on an AOR or line source attacks upwind of the target. The impact assessment may occur at the installation level by using decision support tools or exercising technical reachback.

## OPERATIONAL-ENVIRONMENT ASSESSMENT

D-9. Planners assess civil-military considerations to identify the type of OE. The OE may be permissive, uncertain, or hostile:

- **Permissive.** The military and/or law enforcement agencies should have the control, intent, and capability to assist operations.
- **Uncertain.** The host government forces, whether opposed or receptive to operations, probably do not have effective control of the territory and population in the intended AO.
- **Hostile.** Adversarial forces have a degree of control, the intent, and the capability to effectively oppose or react to operations.

## PREVIOUS-INCIDENT/PAST-USE ASSESSMENT

D-10. The planner collects information on previous uses of CBRN agents or weapons and accidents that may have occurred in the AO. The planner's assessment also considers how an AOR may be affected by secondary hazards from accidental, incidental, or intentional releases by enemies or U.S. forces. Given the prevalence of TIM throughout the world, civilian and DOD planners should use area studies and integrate intelligence estimates to assess possible hazards.

D-11. CBRN threat assessment considers the full spectrum of CBRN threats and hazards (natural, criminal, terrorist, accidental) for a given facility/location. The CBRN threat assessment should examine supporting information to evaluate the likelihood of occurrence for each threat.

D-12. CBRN threat assessments help commanders make better-informed decisions about which protective measures to adopt. They do so by identifying the most likely CBRN threats that units and personnel will face, allowing units to identify the protective and vulnerability reduction measures most likely to keep them safe. When deciding on protective and vulnerability reduction measures, commanders and staffs face two competing goals:

- **Effectiveness.** Effectiveness is adopting appropriate protective measures that will protect units from specific threats that they are most likely to face.



- **Efficiency.** Efficiency is avoiding the adoption of unnecessary protective measures that have significant “costs” (financial costs or diversion of staff time, effort, and focus).

D-13. CBRN threat assessment is not a one-time event, but a process of continuous reevaluation of CBRN threats and hazards throughout each cycle of the operations process to ensure that units continue to have appropriate protective measures in place. Units should—

- Conduct an initial CBRN threat assessment when operations begin and then adopt the appropriate protective measures.
- Update the CBRN threat assessment at regular intervals (to help avoid subconsciously becoming habituated to previously identified threats and hazards) and whenever threats or hazards change.
- Change CBRN protective measures as appropriate.

D-14. The CBRN threat status is a flexible system used to assign the threat a serial number that is determined by the most current enemy situation as depicted by the continuously updated IPOE/IPB process. This system allows local commanders to increase the threat status as conditions change in their AO. Threat status governs the initial deployment of CBRN assets (equipment, units) and the positioning of those assets in the AO. The probability of threat is defined below.

### **Serial 1 (Zero Probability)**

D-15. The opposing force does not possess CB defense equipment, is not trained in CB defense or employment, and does not possess the capability to employ CB warfare agents or systems. Further, the opposing force is not expected to gain access to such weapons; and if they were able to acquire these weapons, it is considered highly unlikely that the weapons would be employed against U.S. forces.

D-16. Under this status, a deploying force would not have to carry CB defense equipment or decontamination assets. However, protective masks should be carried. CBRN personnel should concentrate efforts on monitoring threat communication channels for CB threat indicators.

### **Serial 2 (Low Probability)**

D-17. The opposing force has an offensive CB capability and has received training in defense and employment techniques, but there is no indication of the use of CB weapons in the immediate future. An indication may be the dispersal or deployment of CB munitions or the stated objectives and intent of opposing forces.

D-18. Given this threat status, two options are available: personnel carry their individual protective equipment, or chemical defense equipment stockpiles are identified and readily available for deployment to the operational area if the threat status should increase. CBRN reconnaissance systems deploy to the operational AOI to provide a monitoring capability. Chemical personnel continue to concentrate their efforts on CBRN planning and analysis for threat indicators.

### **Serial 3 (Medium Probability)**

D-19. The opposing force is equipped and trained in CB defense and employment techniques. CB weapons and employment systems are readily available. CB weapons have been employed in other areas of the theater. The continued employment of CB weapons is considered probable in the immediate future. Indicators would be as follows:

- CB munitions deployed to field storage sites or firing units.
- Enemy troops wearing or carrying protective equipment.
- CB reconnaissance elements observed with conventional reconnaissance units.
- CB decontamination elements moved forward.

D-20. Unit CB defense equipment should be prepalletized and located forward for easy access or issued to the Service members who are responsible for their use within the unit. Individual Service members should be at MOPP1 or MOPP2 and MOPP0, if MOPP gear is readily available. Erect collective-protection systems if the tactical situation permits. Personnel and equipment should be kept under cover as much as possible to protect them from contamination. Chemical downwind messages should be sent to subordinate units. Decontamination assets, CB reconnaissance assets, and obscuration support should be deployed as part of the force structure. Detection and monitoring equipment should be issued to the operators. Units should prepare/distribute decontamination equipment.

#### Serial 4 (High Probability)

D-21. The opposing force possesses CB warfare agents and delivery systems. CB defense equipment is available and training status is considered at par or better than that of U.S. forces. CB weapons have already been employed in the theater, and attack is considered imminent. Indicators are—

- CB attack in progress, but not in the current AO.
- CB warnings/signals to enemy troops.
- CB munitions delivered to firing units within range of friendly forces.
- Movement of surface-to-surface missiles to a launch site.

D-22. Unfortunately, this traditional approach to threat levels—using one threat level chart as the only assessment technique—can be problematic. Merely describing the threat as high, medium, low, or zero probability can be dangerous. These terms mean different things to different people and are, by themselves, not useful in identifying appropriate protective measures. If the CBRN threat level is tied inextricably to a set of protective procedures that must be implemented, the procedures adopted may be inappropriate because they do not consider the types of CBRN incidents, the situation in which they will be encountered, their cause, and the likelihood that they will be faced.

D-23. The CBRN threat assessment provides five types of information about the CBRN threats and hazards a unit may face:

- **Types of CBRN attacks.** There are intentional and unintentional releases. Units may take different types of precautions against conventional warfare agents and industrial releases.
- **CBRN threat situations.** Threats may be encountered on installations, in urban environments, aboard watercraft, and other locations. Faced with the threat of a CBRN release or attack, units may take different precautions at installations (collective protection) than they would when conducting operations in combative territories (shelter in place).
- **CBRN threat causes.** The following are the main causes that define the threat environment:
  - **Crime/banditry.** These actions (pranks) are taken by persons with malicious or personal motivations not connected with larger political or military efforts.
  - **Direct threats.** These actions are taken by a belligerent (usually to aid in a political or military effort) for which U.S. territories, faculties, or units are the intended target (attacking a naval base).
  - **Indirect threats.** These actions are taken by a belligerent for which the local population or other belligerents are the intended target, but military units are unintentionally affected (military units hitting an improvised chemical device on a road).
- **CBRN threat level.** This is defined as the likelihood that a unit will face a threat (high, medium, or low). Faced with the possibility of adversarial assault, limited protective measures may be adopted if there is a low threat, but extensive protective measures (collective protection) may be adopted if there is a high threat.
- **Potential changes in the CBRN threat or hazard.** As an example, the protective measures you adopted for a situation with a credible nuclear missile threat will no longer be appropriate if there is a new biological warfare agent threat.

D-24. The CBRN staff incorporates CBRN-related intelligence collection information into the ISR efforts to collect the required information and to confirm or deny enemy COAs. Templated targets are designated as NAIs that may confirm or deny a particular enemy activity. NAIs are shown on the collection plan. (See figure D-1 for a sample collection plan.)

PIR	Indicators	NAI	Time		Specific Order or Request	Tasking		
			Not Earlier Than	NLT		44 Chemical	2-1 Cavalry	1-87 Infantry
Will the enemy use CBRN weapons? Where and when?	CBRN detection equipment	32	2200	900	Check for chemical	X		
	Movement of chemical munitions forward	36	2200	900	Report activity	X		
	Movement of decontamination and CBRN reconnaissance vehicle forward	20	2200	900	Report activity		X	
	Low-order artillery bursts	20	2200	900	Report activity			X
<b>Legend:</b> CBRN                    chemical, biological, radiological, and nuclear NAI                     named area of interest NLT                    not later than PIR                    priority information requirements								

**Figure D-1. Sample collection plan**

D-25. The collection plan assigns responsibilities for collecting information, to include observing NAIs. The CBRN and intelligence staffs and the surgeon provide the indicators for each NAI.

D-26. The CBRN staff addresses the effects of the OE on CBRN operations (soil type, surface drainage, vegetation type and distribution, precipitation, wind patterns, temperature, humidity, cloud cover, topography). This information is key for CBRN staffs to conduct a CBRN hazard assessment. These variables affect agent and radiation persistency and effectiveness and possible contamination areas.

## CHEMICAL, BIOLOGICAL, RADIOLOGICAL, AND NUCLEAR DEFENSE THREAT CONDITIONS

D-27. Upon completion of the initial CBRN threat assessment, the staff recommends changes or revises the CBRN threat condition, allowing the unit, activity, installation, base, ship, or port the opportunity to take the appropriate measures commensurate with the estimated severity of the existing CBRN threat level. (See table D-1, page D-6, for a CBRN threat condition matrix that provides standards for assessing the level of CBRN threat and the protective actions necessary according to STANAG 2984.)

**Table D-1. CBRN threat assessment and conditions matrix**

<i>Threat Condition</i>	<i>Attack Probability</i>	<i>Enemy Indicators</i>	<i>Civil Indicators</i>	<i>Minimum Protective Actions</i>
White: Zero probability (Serial 1)	Negligible	<ul style="list-style-type: none"> <li>No CBRN offensive capability in the AOI</li> </ul>	<ul style="list-style-type: none"> <li>No known industrial hazards or nuclear reactors in the AOI</li> </ul>	<ul style="list-style-type: none"> <li>Verify CBRN equipment.</li> <li>Conduct routine maintenance.</li> </ul>
Green: Low probability (Serial 2)	Possible	<ul style="list-style-type: none"> <li>Offensive CBRN capability</li> <li>No indicators of potential employment in the next 24 hours</li> </ul>	<ul style="list-style-type: none"> <li>Confirmed presence of hazardous industrial materials or nuclear reactors in the AOI</li> </ul>	<ul style="list-style-type: none"> <li>Take all of the above actions.</li> <li>Conduct CBRN training and rehearsals.</li> <li>Conduct CBRN equipment PMCS, to include vehicle and shelter filters.</li> <li>Establish shelter/overhead cover plan.</li> <li>Review MOPP considerations.</li> </ul>
Amber: Medium probability (Serial 3)	Probable	<ul style="list-style-type: none"> <li>Enemy moving, dispersing, or pre-positioning CBRN munitions forward or near delivery systems</li> <li>Enemy wearing protective gear or movement/dispersal of decontamination systems</li> <li>Increased OPSEC of delivery means</li> </ul>	<ul style="list-style-type: none"> <li>Hazardous industrial practices reported</li> <li>Hazardous conditions in storage facilities detected</li> <li>Combat operations being conducted near sites with confirmed hazards</li> </ul>	<ul style="list-style-type: none"> <li>Take all of the above actions.</li> <li>Emplace alarms.</li> <li>Review MOPP considerations.</li> <li>Cover equipment/supplies.</li> <li>Verify alarms/warnings.</li> <li>Brief CBRN teams.</li> <li>Verify mask seals/MOPP.</li> <li>Prepare decontamination site.</li> <li>Erect collective shelters.</li> <li>Issue medical countermeasures.</li> <li>Conduct reconnaissance.</li> </ul>
Red: High probability (Serial 4)	Imminent	<ul style="list-style-type: none"> <li>Enemy ready/certain to employ CBRN munitions</li> <li>CBRN munitions used in AOI; no local contamination hazard present</li> </ul>	<ul style="list-style-type: none"> <li>Localized spill or accident confirmed</li> <li>HN authorities direct limited precautionary evacuation or declare hazard area</li> </ul>	<ul style="list-style-type: none"> <li>Take all of the above actions.</li> <li>Implement MOPP considerations based on METT-TC/METT-T.</li> <li>Monitor continuously.</li> <li>Use vehicle overpressure.</li> <li>Conduct reconnaissance overwatch of NAI.</li> </ul>
Black	Attack occurred	<ul style="list-style-type: none"> <li>CBRN contamination present in AO</li> <li>Germs/toxins detected in AO</li> </ul>	<ul style="list-style-type: none"> <li>Major industrial accident/incident</li> </ul>	<ul style="list-style-type: none"> <li>Take all of the above actions.</li> <li>Conduct reconnaissance.</li> <li>Mark contaminated areas.</li> <li>Find clear routes.</li> <li>Resupply CBRN equipment.</li> </ul>

**Note.** The CBRN threat levels and serial numbers used for assessment purposes are according to STANAG 2984.

**Legend:**

AO	area of operations
AOI	area of interest
CBRN	chemical, biological, radiological, and nuclear
HN	host nation
METT-T	mission, enemy, terrain and weather, troops and support available, and time available
METT-TC	mission, enemy, terrain and weather, troops and support available, time available, and civil considerations
MOPP	mission-oriented protective posture
NAI	named area of interest
OPSEC	operations security
PMCS	preventive-maintenance checks and services
STANAG	standardization agreement

D-28. CBRN threat assessments must be continuously updated to ensure that protective measures remain appropriate; therefore, the threat condition is also continually updated to reflect the heightened or lowered capabilities of a force. A unit CBRN threat condition may change based on—

- The IPOE/IPB reassessments of adversary intent.
- The implementation of vulnerability reduction measures.
- The reduction of protective capabilities.
- A change in friendly-force capabilities (increased CBRN training and enhanced proficiency).

D-29. Throughout the CBRN threat assessment process, information has been gathered to make one final determination—the probability of the use of CBRN weapons or an accidental release.

D-30. A CBRN threat assessment of the probability of the use of CBRN weapons (low, medium, or high) is input for the vulnerability analysis process and other information developed in the vulnerability assessment. (See appendix B for vulnerability assessments.) The vulnerability analysis process is used to determine the overall vulnerability and risk to land, sea, and air forces. (See figures D-2 through D-5, pages D-8 through D-11 for estimations on the probability of use of CB agents and nuclear and radiological weapons.) (See figure D-6, page D-12, for a sample CBRN threat assessment summary.)

## CHEMICAL, BIOLOGICAL, RADIOLOGICAL, AND NUCLEAR THREAT ASSESSMENT PROCESS

D-31. Commanders and staffs must consider the CBRN threat assessment during the planning, preparation, and execution process. The CBRN threat assessment process is continuous and directly tied to the commander's decisions throughout the conduct of operations. The CBRN threat assessment considers—

- **Who.** The first step in conducting a threat assessment is to identify the adversary. The number of nations capable of developing and possessing CBRN weapons is steadily increasing, and it is very difficult to form assessments of nations or groups that have the capability to employ agents.
  - **CBRN-capable nations.** A CBRN-capable nation is one that has the capability to produce or acquire and employ one or more types of CBRN weapons to achieve political and military objectives. Inherent in this capability are varying degrees of abilities to conduct research and development; improve technology; and stockpile, weaponize, and deliver CBRN weapons.
  - **CBRN-capable groups or individuals.** There is significant intelligence and factual data to support the contention that terrorist groups or individuals are also attempting to obtain CBRN capabilities—and succeeding.

---

*Note.* The March 1995 sarin attack in the Tokyo subway by the Aum Shinrikyo religious cult demonstrated this capability.

---

- **What.** An assessment of the adversary CBRN capability that may be used will likely depend on adversary goals. For example, adversary-induced releases in the operational area could be low-technology, high-impact events intended only to disrupt or halt operations. Each CBRN capability has advantages and disadvantages.
  - **Chemical.** The effects of chemical agents are primarily casualty-producing effects and contamination. The personnel performance degradation produced by the prolonged wear of MOPP gear can also have a significant impact on friendly forces. (See *Multiservice Tactics, Techniques, and Procedures for Nuclear, Biological, and Chemical (NBC) Protection* for a detailed explanation of MOPP levels.)
  - **Biological.** Biological agents can produce large numbers of casualties. Additional effects resulting from a biological attack (infectious diseases, mass casualties, large-area effects, degradation from MOPP gear wear, restriction of movement) can also have significant impacts on friendly forces.

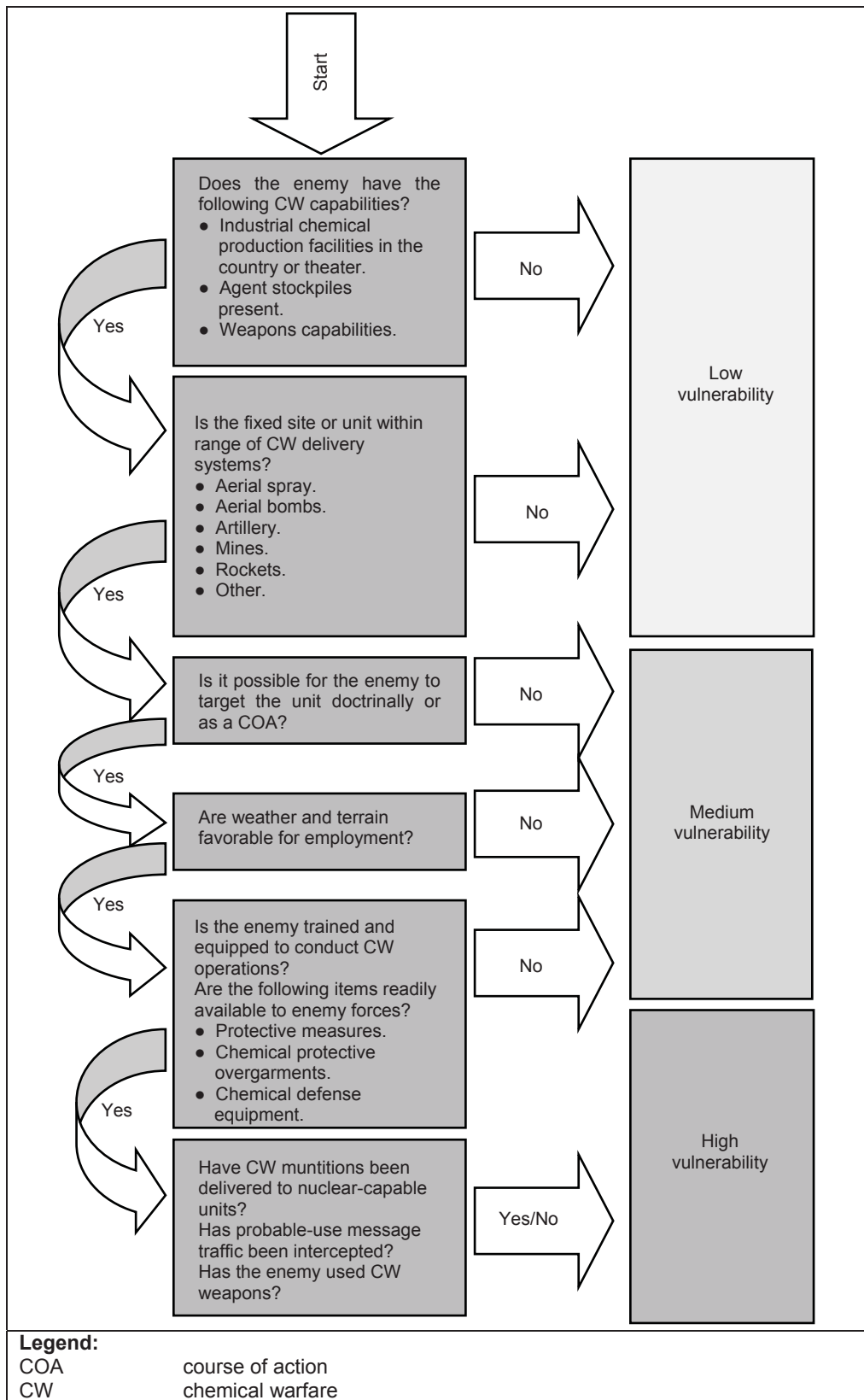

Figure D-2. Chemical-agent, probability-of-use estimation

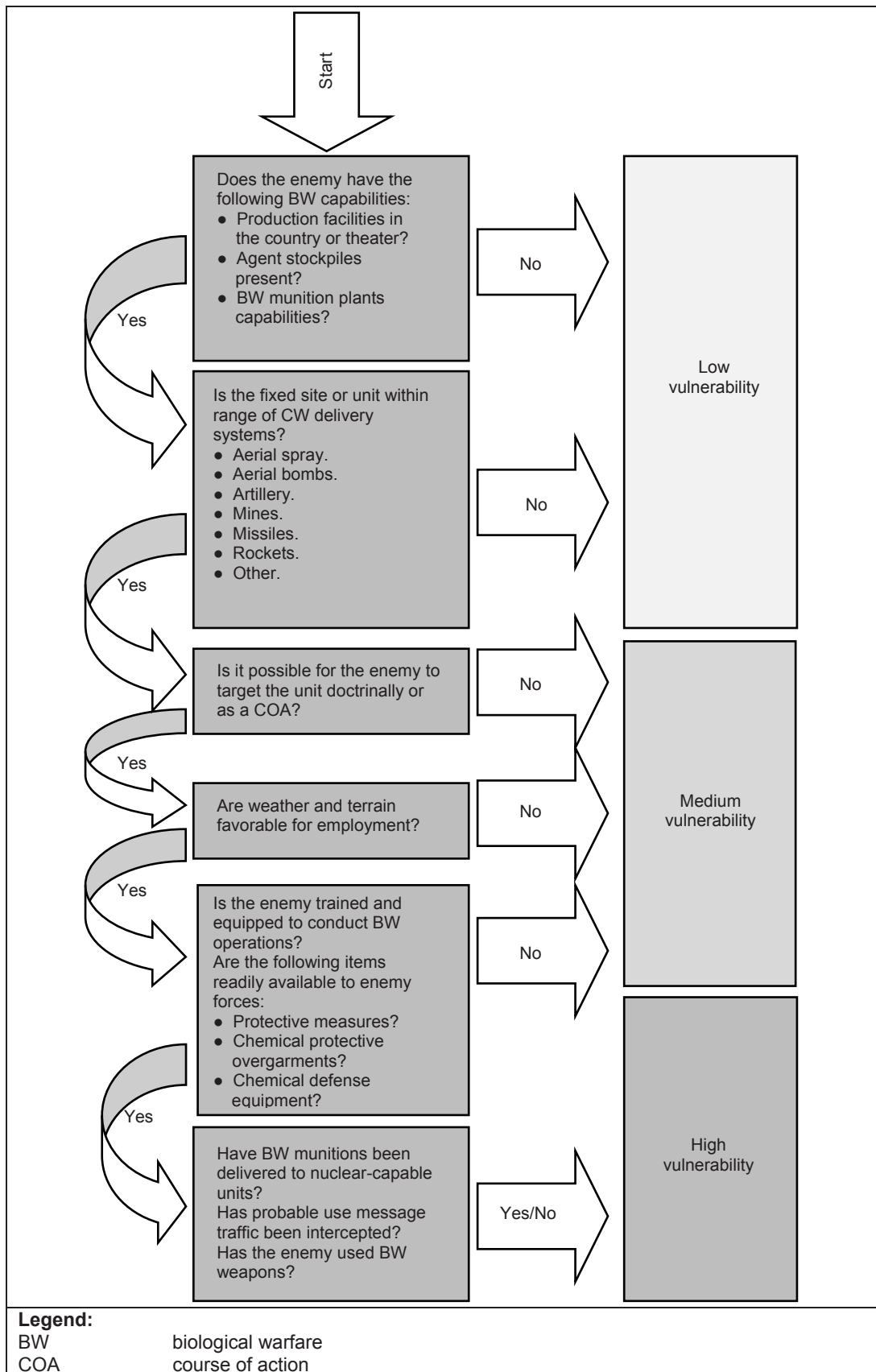

Figure D-3. Biological-agent, probability-of-use estimation



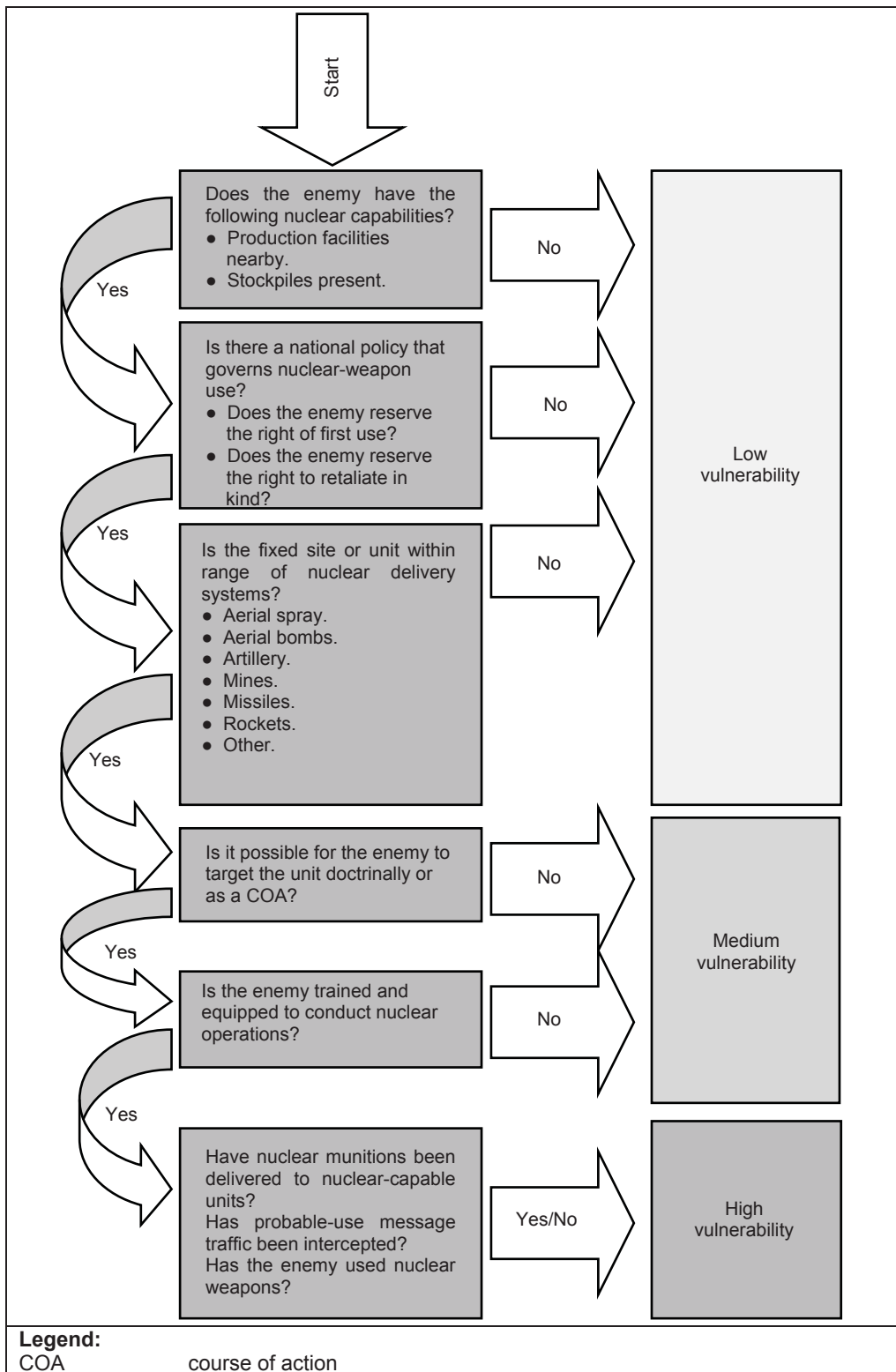

Figure D-4. Nuclear-weapon, probability-of-use estimation

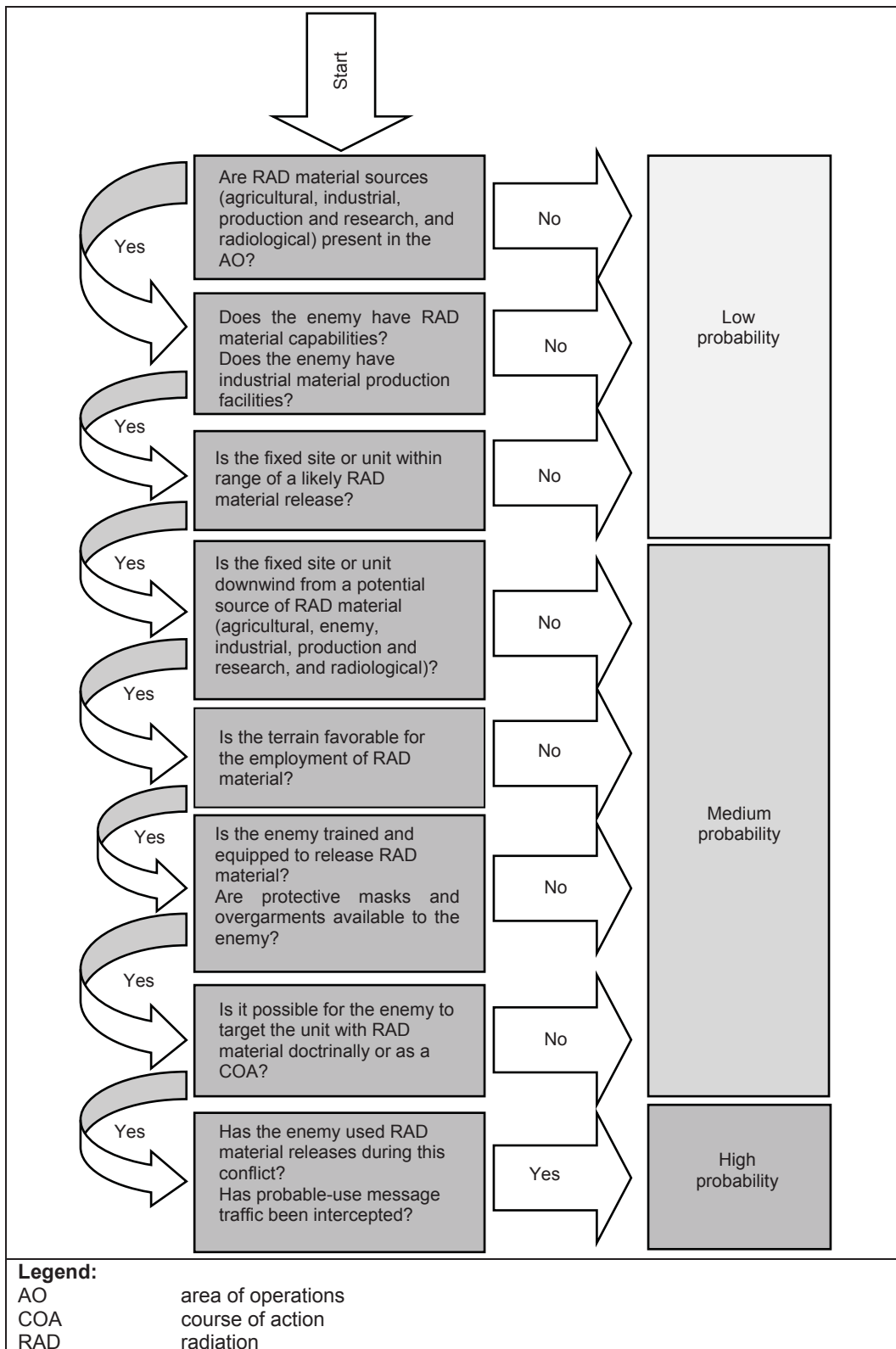

Figure D-5. Radiological-weapon, probability-of-use estimation

UNCLASSIFIED

**Subject: Corps CBRN Treat Assessment and Summary**

1. **(U) Purpose.** To provide forces with the monthly CBRN threat assessment and summary to attempt to forecast potential CBRN threats, hazards, and enemy intent for the next 30 to 60 days to develop mitigation measures necessary to protect the force.
2. **(U) Overall Assessment.**
  - a. **(U) THREATCON Levels.** The Corps CBRN threat assessment working group continues to assess the overall CBRN attack threat as low. Minimum MOPP is ready. See the table below for the CBRN THREATCON levels:

Chemical	White/Green/Amber/Red/Black
Biological	White/Green/Amber/Red/Black
Radiological	White/Green/Amber/Red/Black
Nuclear	White/Green/Amber/Red/Black
Weaponized hazardous materials	White/Green/Amber/Red/Black
White	Negligible
Green	Possible
Amber	Probable
Red	Imminent
Black	Attack has already occurred

- b. **(U) Capability.** Enemy forces possess the ability to employ conventional chemical weapons, but appear to have limited stockpiles. They do not possess the technology to employ biological weapons or radiological-dispersal systems, but reportedly have been experimenting with methods to use toxic industrial chemical-enhanced IEDs on coalition forces. (No change.)
    - c. **(U) Opportunity.** Although the normal cold temperatures and humidity this time of year could be favorable for using chemical weapons, the extreme wind speeds and unpredictable wind direction cancels its potential effectiveness against coalition forces in desert and mountainous terrain. However, large urban areas with tight building structures, narrow streets, and narrow valleys will tend to favor the duration of nonpersistent chemical agents. With the enemy in a defensive mode of the past several months, limited offensive chemical strikes against coalition targets or covert employment of TIC-enhanced IED might be seen as a timely option.
    - d. **(U) Intent.** Currently, national army leaders do not appear to be willing to support an offensive campaign of this nature due to significant CB defense training and equipment shortfalls. Independently operating local militia or rogue elements are spread thin, disorganized, and poorly equipped, but seem to be looking for new ways to flex their muscle.
3. **(U) Trend Summary.** Small to medium caches of conventional chemical munitions are still being found on the average of 1 every 6 to 8 weeks, which is a significant decrease from this time last year. No new IED manufacturing facilities containing potential chemical rounds or TIC have been found in the last 3 months.

*[Insert a chart or spreadsheet if available]*

4. **(U) Potential Enemy COA.**
  - a. **(U) Chemical Weapons.** National army forces may employ conventional chemical weapons using artillery in delivery systems or tied in with IEDs. Potential targets would be along main supply routes, at ports, and in forward operating bases. Rogue elements may also attempt to use conventional chemical weapons or TIC-enhanced IEDs in urban areas to cause widespread fear and panic.
  - b. **(U) Biological Weapons.** N/A.
  - c. **(U) Radiological-Dispersal Devices.** N/A.
5. **(U) Enemy Most Likely COA.** Due to the increased disruption of enemy C2 systems, field commanders will most likely not be able to carry out offensive operations using conventional chemical weapons. Rogue elements continue to face many challenges and may seriously consider taking the opportunity to demonstrate power to gain some much-needed momentum. Increased experimental use of TIC-enhanced IEDs in urban areas will most likely be the greatest threat to coalition forces. Due to the low temperatures and restricted terrain, chemicals may be somewhat effective in causing many casualties on both civilians and coalition forces.

**Figure D-6. Sample CBRN threat assessment summary**

<p>6. <b>(U) Enemy Most Dangerous COA.</b> The enemy employment of chemical weapons on seaports of entry would be the most devastating to coalition forces in terms of sheer military and civilian casualties and the long-term disruption of logistics support.</p> <p>7. <b>(U) Neighboring Countries and Transnational Entities.</b> Covert assistance on the northern border in the form of chemical weapons or weaponized hazardous materials is possible, but not likely at this time. There have been no reports of any such activity.</p> <p>8. <b>(U) Vulnerability or Former WMD Sites.</b> All known WMD storage and production facilities have been destroyed or are under direct coalition control.</p> <p>9. <b>(U) Weather Impacts on CBRN Agents.</b></p> <ol style="list-style-type: none"> <li><b>(U) Temperature.</b> Average temperatures are 5°C, which is favorable.</li> <li><b>(U) Humidity.</b> Relative humidity is 25 percent, which is favorable.</li> <li><b>(U) Wind Speed.</b> Average wind speed is 15 to 20 mph, which is favorable.</li> </ol> <p>10. <b>(U) Key events.</b> 1 Dec 09, medium-sized cache (30 rounds) of unmarked munitions were found. Several of them were leaking. Two Soldiers experienced redness of the skin on their hands and face and were evacuated to the nearest MTF. The presence of a blister agent in 5 of the rounds was identified using ICAM and confirmed with hazardous materials identification.</p> <p>11. <b>(U) CBRN Defense Assets.</b></p> <p style="text-align: center;"><i>[Insert a map with CBRN icons]</i></p> <p>12. <b>(U) Command and Signal.</b> Corps CBRN cell location—corps main command post. <i>[Include DSN and commercial telephone numbers].</i></p> <p style="text-align: center;">UNCLASSIFIED</p>																																		
<p><b>Legend:</b></p> <table> <tr> <td>C</td> <td>chemical</td> </tr> <tr> <td>C2</td> <td>command and control</td> </tr> <tr> <td>CB</td> <td>chemical and biological</td> </tr> <tr> <td>CBRN</td> <td>chemical, biological, radiological, and nuclear</td> </tr> <tr> <td>COA</td> <td>course of action</td> </tr> <tr> <td>Dec</td> <td>December</td> </tr> <tr> <td>DSN</td> <td>Defense Switched Network</td> </tr> <tr> <td>ICAM</td> <td>improved chemical agent monitor</td> </tr> <tr> <td>IED</td> <td>improvised explosive device</td> </tr> <tr> <td>MOPP</td> <td>mission-oriented protective posture</td> </tr> <tr> <td>mph</td> <td>miles per hour</td> </tr> <tr> <td>MTF</td> <td>medical treatment facility</td> </tr> <tr> <td>N/A</td> <td>not applicable</td> </tr> <tr> <td>THREATCON</td> <td>threat condition</td> </tr> <tr> <td>TIC</td> <td>toxic industrial chemical</td> </tr> <tr> <td>U</td> <td>unclassified</td> </tr> <tr> <td>WMD</td> <td>weapons of mass destruction</td> </tr> </table>	C	chemical	C2	command and control	CB	chemical and biological	CBRN	chemical, biological, radiological, and nuclear	COA	course of action	Dec	December	DSN	Defense Switched Network	ICAM	improved chemical agent monitor	IED	improvised explosive device	MOPP	mission-oriented protective posture	mph	miles per hour	MTF	medical treatment facility	N/A	not applicable	THREATCON	threat condition	TIC	toxic industrial chemical	U	unclassified	WMD	weapons of mass destruction
C	chemical																																	
C2	command and control																																	
CB	chemical and biological																																	
CBRN	chemical, biological, radiological, and nuclear																																	
COA	course of action																																	
Dec	December																																	
DSN	Defense Switched Network																																	
ICAM	improved chemical agent monitor																																	
IED	improvised explosive device																																	
MOPP	mission-oriented protective posture																																	
mph	miles per hour																																	
MTF	medical treatment facility																																	
N/A	not applicable																																	
THREATCON	threat condition																																	
TIC	toxic industrial chemical																																	
U	unclassified																																	
WMD	weapons of mass destruction																																	

**Figure D-6. Sample CBRN threat assessment summary (continued)**

- **Radiological and nuclear.** The effects of a nuclear detonation are primarily in three areas: thermal radiation, blast, and radiological. Additional effects (electromagnetic pulse) can break down electronics system protection, disrupt communications, and have a significant psychological impact on friendly forces. The short- and long-term effects of radiological exposure of personnel must be monitored to minimize the degradation of individual and unit performance.
- **Unintentional releases.** The effects of unintentional releases can produce casualties in humans and animals and damage plants, wildlife, and other material. Consequences from an unintentional release (infectious diseases, mass casualties, large-area effects, restriction of movement, contamination, degradation from MOPP gear wear, quarantine) can have significant impacts on friendly forces. Unintentional releases can also have long-term effects on personnel and the natural environment.

- **When.** Understanding adversary CBRN weapons employment concepts can enhance the ability to predict if and when an adversary may use CBRN weapons. Many of the former Soviet-influenced doctrinal precepts have been learned by potential enemies and still remain even after the end of the Cold War; however, defining when an adversary may use CBRN weapons largely remains only an estimate. The enemy employment of CBRN weapons could occur at unexpected times and locations.
- **Where.**
  - Ports, airfields, supply depots, railheads, maintenance facilities, and major command headquarters are potential targets for CBRN attacks. Fixed-site commanders and staffs will assess their vulnerability and may use vulnerability checklists to support that process.
  - Enemy forces operating in the rear area could contaminate critical command headquarters or supply facilities and significantly affect the responsiveness of support organizations. Additionally, because of the proliferation of CBRN weapons, future campaign locations may be fought on an asymmetric battlefield.
- **Why.** The motivation behind the threat to use CBRN weapons can assist the commander and his/her staff in assessing adversary intent to use CBRN weapons. The motivation to use these weapons may be to cause casualties, contamination, or degradation or strictly for the psychological impact. For example, the psychological impact of CBRN weapons may cause panic or mob behavior among civilians.
- **How.** The employment of CBRN weapons may depend on the perceived advantage gained by their use at the tactical level.
  - **Persistent and nonpersistent agents.** The use of nonpersistent agents against front-line positions or against amphibious forces operating in littoral (situated or growing on or near a shore) areas; use of persistent agents on bypassed positions, strong points, and flanks; or use of persistent or nonpersistent chemical agents in barrier and denial plans could impact operations. These tactics may be favored by combatants from developing nations who have adequate chemical stocks and use former Soviet doctrine.
  - **Radiological agents.** The select use of casualty-producing biological agents could cause casualties within hours versus days.
  - **Nuclear devices.** The use of tactical nuclear devices could cause large numbers of casualties, damage, and contamination through thermal radiation, blast, and nuclear radiation. Injuries to personnel can range from skin burns and flash blindness to radiation sickness, extreme psychological effects, and death.

D-32. CBRN battle staffs and subordinate leaders help commanders by monitoring the numerous factors that can influence the outcome of operations and by providing timely information that is needed for decisions. They focus their assessments on identified effects and specified tasks issued to subordinates. Generally, the level at which a specific operation, task, or action is directed should be the level at which it is assessed. This reduces redundancy and enhances the efficiency of the overall assessment process.

D-33. Most of the information required for CBRN threat assessments will not be based on personal, firsthand experience. The following techniques are used to obtain this information (each approach has its own strengths and limitations; therefore, it is important to use all four together to conduct a credible threat assessment).

- **Conducting interviews.** Careful, structured interviews on the CBRN threats or hazards other units have faced can provide human intelligence, basic information, and a frame of reference for focusing other CBRN assessment techniques. In some cases, this approach will not lead to meaningful conclusions because the validity of answers to the questions is unknown. (See table D-2 for other questions that may indicate whether the information is accurate.)

Table D-2. Information accuracy questions

Questions	Yes	Somewhat	No
About the person providing the information:			
• Does he/she have direct access to the information?			
• Has information that he/she reported in the past been reliable?			
• Does he/she believe you could verify the information?			
• Will he/she benefit from your reaction to the information?			
• Does he/she expect to have a continuing relationship with you?			
• Have you known him/her for some time?			
About the information:			
• Does it make sense, given what you already know about the situation?			
• Do you have information consistent with it?			
• Do you have information that contradicts it?			

- **Analyzing patterns and trends.** The examination of quantitative information on past CBRN incidents helps identify the most common features of CBRN incidents (patterns) and changes in them (trends). Pattern/trend analysis may yield sufficiently reliable and specific information on threats (what areas or types of units are attacked) on which to base protective measures. A CBRN incident data collection worksheet can help collect data and present it clearly for analysis. (See figure D-7 for a sample CBRN incident data collection worksheet.)

CBRN Incident Data Collection Worksheet					
Area _____	Interview _____	Date _____			
Date/time	Location	Incident type	Situation	Cause	POC
<b>Situation:</b> V (vehicle), S (Site), O (other).					
<b>Cause:</b> C/B (crime/banditry), D (direct threats) or I (indirect threats).					
<b>Legend:</b> CBRN                    chemical, biological, radiological, and nuclear POC                     point of contact					

Figure D-7. Sample CBRN incident data collection worksheet

- **Gauging the threat level.** CBRN threat levels serve as markers for establishing the level of CBRN threat posed by an adversary. In most instances, you will not be able to draw exclusively on pattern/trend analysis to gauge the CBRN threat level; therefore, the CBRN staff must develop information for integration into the various staff estimates. There are many such factors for each of the three major causes of threats.
- **Looking for indicators that CBRN threats may change.** Threat indicators and events that suggest possible changes in the CBRN threat or hazard environment are useful tools for considering future CBRN threats.

D-34. The CBRN threat to military forces from terrorist organizations is not definitive. Intelligence reporting indicates that nearly 40 terrorist organizations, insurgent groups, or cults have used, possessed, or expressed an interest in CBRN agents or weapons. However, the level of competence of these terrorist organizations in developing and effectively employing CBRN is not well understood. It is also true that military forces present challenges that might cause a terrorist to consider, more favorably, a softer, civilian target. Nevertheless, military resources are vital to national security and it is prudent to provide a responsible level of CBRN protection to military personnel and infrastructure that balances the cost of providing that protection with the security improvements that result.

D-35. The CBRN staff must analyze the protection level required for friendly forces to withstand a CB attack. This information is vital to the commander for the successful accomplishment of the mission because the commander may be required to reallocate or reposition units in the AO to reduce vulnerability to an attack. The appropriate protection level is established by analyzing the following mission, environment, and warfighter factors:

- Mission and commander’s intent for friendly forces.
- Capabilities and level of training of friendly forces.
- MOPP analysis and work degradation factors contained in *Multiservice Tactics, Techniques, and Procedures for Nuclear, Biological, and Chemical (NBC) Protection*.
- Availability of chemical defense equipment and decontamination assets. In this regard, information may be obtained from the plans staff officer.
- Location and availability of desalination plants (for arid areas).
- Location of civilian chemical manufacturing and storage facilities. Chemicals at these facilities may be used, through civilian contract, for supplementary decontamination supplies. Further, chemicals or hazardous materials stored in these facilities may produce areas of contamination if storage containers leak (intentional or unintentional).
- Availability of civilian contracted labor and water transport for decontamination operations.
- Location of car washes for urban areas. Car washes may be used in lieu of hasty decontamination stations.
- Data on local fire hydrants (location and hookups). Hydrants may be used to provide water for decontamination operations.

## CHECKLIST

D-36. Principal CBRN staff elements of operational and tactical commands can use a checklist to evaluate the readiness of assigned forces; commanders and staffs may use the checklist for characterizing and dealing with CBRN threats and hazards while conducting multi-Service military operations. This checklist is not all-inclusive and is organized to provide a series of considerations and questions that will provide insight into functional area readiness. (See Table D-3 for CBRN threat assessment checklist questions.)

**Table D-3. CBRN threat assessment checklist questions**

How well do we understand the CBRN threat?
What is the threat?
Which adversaries have verified CBRN threats?
Which adversaries are thought to have a CBRN threat?
By adversary, what chemical agents are known to be on hand?
By adversary, what chemical agents are thought to be available?
By adversary, what biological agents are known to be on hand?
By adversary, what biological agents are thought to be available?
What and how many delivery systems are available to the enemy?
Are CB preventive measures by adversaries (inoculation, training) being noted?
Is there threat of accidental release?
How have we considered the collateral damage threat posed by industrial compounds?
Will coalition forces be subjected to environmental hazards that have aspects similar to deliberate chemical-agent attacks and, if so, what?
What specific environmental hazards have been identified that might affect coalition proposed routes of advance of withdrawal?
Where are WMD production facilities/stockpiles?
How will the CBRN threat be employed?
When do we anticipate an attack in terms of deployment?
What is the most likely type of strike that might occur early in the deployment process?



**Table D-3 CBRN threat assessment checklist questions (continued)**

What is the anticipated priority of attack against ports, airfields, and similar locations?
Is the enemy conducting noticeable reconnaissance of these ports, airfields, and similar locations?
What are the enemy agents of choice for specific scenarios?
What is the stated national resolve and capability of the enemy regarding WMD employment in the region and in CONUS to prevent or disrupt deployment?
What WMD terrorism threat exists?
What is the enemy-anticipated CONOPS with the regard to employment of WMD? For example, is the enemy expected to use CBRN to disrupt OPTEMPO, cause MASCALs, or both?
Will the adversarial use of CBRN agents or weapons increase their regional prestige and/or alter the psychological balance?
Will the adversaries be able to threaten U.S. forces throughout the depth of their deployment?
Have friendly/neutral population centers been identified as potential targets?
What friendly commercial chemical or radiological facilities are potential targets?
What effect will threat employment have on our operations?
Which pre-positioned storage areas are critical to the allied effort?
What is the vulnerability of storage areas for pre-positioned assets?
What is the enemy resolve and threat toward noncombatant U.S. citizens in theater?
What level of deployment degradation will the enemy seek to achieve using CBRN weapons?
What are the impacts of threat CBRN usage with respect to psychological, medical, or logistical implications?
Will the use of WMD impact the cohesiveness of coalitions? If so, how?
Which ports and airfields will be prime targets for enemy use of CBRN agents under current OPLANs?
Will using CBRN agents produce a strategic, political, and/or psychological effect that overshadows its actual military utility?
What are the priorities for CBRN threat information?
Have appropriate intelligence activities been tasked to develop the CBRN threat?
Which agencies are developing the CBRN threat?
What resources does the commander have for obtaining CBRN threat data when deployed?
What is the timeliness of CBRN threat data?
How are the above resources informed of specific information to be watching for?
What system is in place to prioritize intelligence requests?
Have we pieced together the various intelligence reports to identify and deconflict contradictory information?
How is contradictory information deconflicted?
Which staff sections or personnel contribute to deconflicting CBRN intelligence?
What criteria is in place to determine when a piece of information should be incorporated into planning?
Have we disseminated this information to the whole team (Services, planners, Office of the Joint Chiefs of Staff, and units)?
When is data considered ready to be sent out to other team members?
How is CBRN threat data routed?
How and when do we share information and conclusions with actual or potential allies (coalition partners)?
What is the threat to HN population/forces, and how might this impact coalition operations?
What HN emergency response and reporting agencies are included in the dissemination of CBRN data? When? What types of data?

**Table D-3 CBRN threat assessment checklist questions (continued)**

Do we have the capability to monitor for changes to the threat and rapidly disseminate major changes?
What types and ranges of CBRN agents does the threat force possess?
Where are the threat CBRND forces and CBRN weapons and delivery systems?
When can those systems affect the unit in the OE?
Do the commander, CBRN staff officer, and unit leaders integrate and link good environmental actions to sound tactical doctrine and TTP as the standard for military operations?
Are military actions for environmental protection an essential part of military planning, training, and assessment operations?
Are environmental threats to population safety and well-being recognized? (U.S. and HN citizens value and demand a clean and healthy environment.)
As described in NEPA, are the environmental consequences of the commanders' proposed actions considered before making decisions?
The level of environmental consideration exercised depends on the scope of the action, the extent of public interest, and the potential for environmental impacts. Are leaders consulting operational staff on NEPA- and HN-related issues? (NEPA concerns are usually installation- or operational-level unit considerations.)
Major accidents and natural disasters occur on a continuing basis and may involve CBRN agents and materials. Are potential, naturally occurring hazards that may affect operations (recent outbreaks of illness or contaminated patients in hospitals) identified?
What is the time period of interest?
What are adversary probable threat COAs and intent?
What are the NAIs and TAIs?
What is the summary of enemy activity, including CBRN attacks, movements of CBRN equipment or material, presence and level of training of threat forces, or indicators of enemy CBRN warfare interest (queuing-up weather radar)?
What is the direction and speed of prevailing winds?
What is the average temperature and humidity, and how may these weather conditions affect CBRN warfare agents?
What are the terrain and operating surfaces of concern in the AO?
What is the availability of water sources?
What transportation assets (railways, airfields, road networks) are available for shipment of CBRN munitions?
What is the availability and location of industrial assets capable of producing and/or weaponizing CBRN warfare agents?
What is the availability of CBRN agents, and delivery systems and the location of stockpiles?
What are the casualty percentages, based on target size?
What are the casualty percentages, based on weapon systems?
What is the availability of CBRND equipment to enemy forces? (If no protective equipment is available [MOPP, antidotes, masks], it may indicate that the enemy does not intend to use CBRN weapons).
What is the amount of overhead cover or COLPRO shelters or systems? (If enemy forces seek overhead cover or move into COLPRO shelters, it may indicate that the enemy intends to use CBRN weapons.)
What is the stated national policy or philosophy on the use of CBRN weapons? Has the enemy declared a policy of no use, first use, or limited use only for retaliation in kind? Does the enemy consider the use of flame or OBS as CBRN agents?
Is the enemy national or military leadership willing to use CBRN weapons on their own territory or expose their own populations to the hazards generated by CBRN munitions?

**Table D-3. CBRN threat assessment checklist questions (continued)**

What is the future potential for CBRN use? If the enemy does not possess CBRN munitions, the capability to produce agents, or expertise to employ munitions, have attempts been made to gain this ability? (Reports indicating the presence of advisors from other nations working with enemy forces, international trade agreements, or shipments of agricultural equipment [sprayers, fertilizers, insecticides, or raw chemicals] may provide insight in to enemy intent.)	
<b>Legend:</b>	
AO	area of operations
AR	Army regulation
CB	chemical and biological
CBRN	chemical, biological, radiological, and nuclear
CBRND	chemical, biological, radiological, and nuclear defense
COLPRO	collective protection
CONOPS	concept of operation
CONUS	continental United States
HN	host nation
MASCAL	mass casualty
MCO	Marine Corps order
MOPP	mission-oriented protective posture
NAI	named area of interest
NEPA	National Environmental Policy Act
OBS	obscuration
OE	operational environment
OPLAN	operation plan
OPTEMPO	operating tempo
TAI	target area of interest
TTP	tactics, techniques, and procedures
WMD	weapons of mass destruction

D-37. The major topics generally relate to the information requirements within the purview of the intelligence staff officer, operations staff officer logistics staff officer, plans staff officer, and information operations staff officer. However, AOIs that require collaboration with the surgeon general, public affairs, civil-military operations, and legal staffs are also included. The questions that follow will lead to identification of mission areas that are strongly postured for dealing with CBRN threats and hazards or capabilities that are in need of improvement. (See tables D-4 through D-7, pages D-20 through D-23, for additional CBRN threat assessment considerations.)

**Table D-4. Crime/banditry threat**

<i>Threat Level Factors</i>	<i>Low Threat</i>	<i>Medium Threat</i>	<i>High Threat</i>
Crime mobility	Criminals almost always remain in high-crime areas and do not enter areas near friendly AORs.	Criminals are rare during the day, but roam freely at night, often entering areas near friendly AORs.	Criminals or gangs roam freely at night and target expatriates in areas near friendly AORs for burglaries and violent crime.
Crime ambiance	Unit sites are surrounded by low-crime buffer zones which (though unsafe at night due to street crime) keep most criminals away from unit sites.	Unit sites are near high-crime areas which are unsafe due to street crime (day and night).	Unit sites are near high-crime areas in which criminals and gangs operate freely and where street and residential crime may be violent.
Size of criminal groups	Criminals usually operate alone or with 1 partner and avoid gratuitous violence and confrontations.	Criminals usually operate in groups of 2 to 4 and usually avoid gratuitous violence and confrontations.	Criminals usually operate in groups larger than 4, are frequently confrontational, use gratuitous violence, and are prone to use deadly force against victims.

Table D-4. Crime/banditry threat (continued)

<i>Threat Level Factors</i>	<i>Low Threat</i>	<i>Medium Threat</i>	<i>High Threat</i>
Police deterrence and response	Police/security forces partially deter crime and usually respond quickly enough to disrupt burglaries.	Police/security forces sometimes deter crime, respond slowly to calls, and only occasionally apprehend suspects after a criminal act.	Police/security forces are ineffective at deterring crime, rarely respond to calls, and seldom arrest suspects.
Police training and professionalism	Police/security forces are reasonably well trained and generally professional, but may lack manpower and resources to be fully responsive.	Police have some training and limited professionalism, are somewhat apathetic to emergency calls, and are too limited in manpower and resources to significantly deter crime and respond effectively.	Police do not exist; are untrained, inept, corrupt, and unresponsive; or collaborate with criminals to allow them to carry out crimes with police protection.
Professionalism of military forces	Troops are regularly paid, professional, well disciplined, and treat others with respect.	Troops are rarely paid, somewhat disciplined, treat people with suspicion, and sometimes pillage and steal goods.	Troops are young recruits, not paid, and ill-disciplined; treat people with disdain; and regularly steal whatever they want.
Military leaders' control over subordinate troops	Leaders appear to have good control over their troops and can be effectively appealed to with problems.	Leaders have some control over their troops and appealing to them with problems sometimes results in action.	Leaders appear to have little control over their troops and have shown no ability to control them when appealed to.
General sense of security	There is a general sense of security, although crime occurs.	There is a general sense of insecurity, though not lawlessness.	There is a general sense of lawlessness and impunity.
<b>Legend:</b> AOR                      area of responsibility			

Table D-5. Indirect CBRN threat

<i>Threat Level Factors</i>	<i>Low Threat</i>	<i>Medium Threat</i>	<i>High Threat</i>
Knowledge of conflict locations	The areas are controlled by each belligerent.	The general areas are controlled by each belligerent.	The areas that are controlled by each belligerent cannot be identified.
Distance from disputed areas	Operations are distant from areas over which belligerents are fighting.	Operations are near areas over which belligerents are fighting, or forces must sometimes cross into such areas.	Operations are within areas over which belligerents are fighting.
Fluidity of conflict	Areas under belligerents' control and in dispute rarely change; and when they do, they change slowly, slightly, and with significant warning.	Areas under belligerents' control or in dispute sometimes change, usually with some warning.	Areas under belligerents' control and in dispute change often, quickly, significantly, and with no warning.

Table D-5. Indirect CBRN threat (continued)

<i>Threat Level Factors</i>	<i>Low Threat</i>	<i>Medium Threat</i>	<i>High Threat</i>
Knowledge of areas with improvised devices	Mined areas are known, mined areas are well marked, and there is a single, reliable resource to gain land mine information.	You know most of the mined areas, most mined areas are marked, and there is a usually reliable resource to provide most land mine information.	Mined areas are not known, mined areas are seldom marked, and there is no single, reliable resource for land mine information.
Distance from mined areas	NGO operations are distant from mined areas.	Forces must sometimes go into areas with mines, but they stay on paved/well-traveled roads.	Operations are within mined areas.
Continuance of land mine laying	Belligerents have shown that they are incapable and/or unwilling to lay new mines.	Belligerents are capable of laying new mines, and they have sometimes done so in areas or on roads that are known to often contain mines.	Belligerents have demonstrated a capability and willingness to continue to lay mines in unexpected places.
Belligerent tactics and weapons	Belligerents seldom use tactics and weapons that are likely to result in units becoming unintentional victims.	Belligerents sometimes use tactics and weapons that may result in units becoming unintentional victims (riots, raids, cordon and search operations, sniper fire)—though there are clear patterns and usually some warning.	Belligerents often use tactics and weapons that are likely to result in units being unintentional victims (land mines, terrorist attacks, artillery shelling, bombing)—with no clear patterns and little warning.
<b>Legend:</b> NGO                      nongovernmental organization			

Table D-6. Direct CBRN threat

<i>Threat Level Factors</i>	<i>Low Threat</i>	<i>Medium Threat</i>	<i>High Threat</i>
Capability	Belligerent currently has limited military CBRN capabilities near areas in which units operate.	Belligerent has some military CBRN capabilities near areas in which units operate.	Belligerent has significant military CBRN capabilities in areas in which units operate.
Economic motivation	No belligerent needs relief aid as a source of support (food, militarily valuable equipment and supplies, money, equipment and supplies that can be sold).	One or more belligerents rely on relief aid as one source of support or want to ensure that other belligerents do not benefit from it.	One or more belligerents rely heavily on relief aid; losing access to it would severely undermine their chances of success.
Politico-military motivation	Rebel groups have no politico-military motivations for attacking units (do not need to gain recognition, would not benefit from provoking a government overreaction, or demonstrate lack of government control in an area).	Rebel groups have some politico-military problems that could be ameliorated by targeting units.	Rebel groups are desperate and need to change the course of a conflict or risk losing.

Table D-6. Direct CBRN threat (continued)

<i>Threat Level Factors</i>	<i>Low Threat</i>	<i>Medium Threat</i>	<i>High Threat</i>
History	Belligerent has never targeted units.	Belligerent has sometimes targeted units.	Belligerent has often targeted units in the past.
Intention	Belligerent is friendly, works to facilitate unit work, and has never threatened units.	Belligerent has expressed unease over unit work, subtly impedes unit efforts, and has sometimes made veiled threats against units.	Belligerent opposes the work of units (stating that they aid their opponent), and has recently made clear and unambiguous threats.
Security force capability	Local military or security forces effectively deter belligerent from threatening units and protect units from threats.	Local military or security forces sometimes deter belligerent from threatening units and can offer some protection to units.	Local military or security forces can neither deter belligerent from threatening units nor protect units.
Political constraints	There is significant and effective international and local pressure to prevent the belligerent from threatening units.	There is occasional international and local pressure that somewhat limits the belligerent's freedom to threaten units.	There is no effective pressure limiting the belligerent from threatening units.
<b>Legend:</b> CBRN                      chemical, biological, radiological, and nuclear			

Table D-7. Additional enemy indicators

<i>Threat Type</i>	<i>Indicators</i>
<b><i>Indicators of Possible/Probable Change</i></b>	
Crime/banditry	<ul style="list-style-type: none"> <li>• Demobilization of Soldiers.</li> <li>• Worsening unemployment and economic conditions (inflation decreasing "real" income).</li> <li>• Budget constraints resulting in lower pay to Soldiers or police.</li> <li>• New splits within military/rebel command structures (which can lead to less control over Soldiers).</li> </ul>
Direct CBRN threats (being targeted)	<ul style="list-style-type: none"> <li>• Events that increase a belligerent's need for CBRN resources (a new offensive).</li> <li>• Change in rebel alliances.</li> </ul>
Indirect CBRN threats (caught in the crossfire)	<ul style="list-style-type: none"> <li>• Increased use of indiscriminate weapons and tactics (artillery, CBRN devices).</li> <li>• New military offensives for which there are no clear battle lines.</li> </ul>
<b><i>Indicators of Imminent Conflict</i></b>	
Military force (preparations)	<ul style="list-style-type: none"> <li>• Work/repair of military positions.</li> <li>• Military convoys on the road.</li> <li>• Stockpiling of food, supplies, and IPE.</li> <li>• Increased recruiting.</li> <li>• Public blood collection drives.</li> <li>• Unit rotations (better CBRN-equipped units arriving).</li> <li>• Departure of Soldiers' families.</li> <li>• New checkpoints.</li> <li>• Checkpoints manned by Soldiers in IPE instead of police.</li> <li>• Mines laid near military positions.</li> <li>• Dumped medical supplies (prophylaxes) near MTFs.</li> <li>• Designation of restricted areas (especially near borders).</li> </ul>

Table D-7. Additional enemy indicators (continued)

<i>Threat Type</i>	<i>Indicators</i>
<i>Indicators of Imminent Conflict (continued)</i>	
Local population (preparations)	<ul style="list-style-type: none"> <li>• Departures of families from the area.</li> <li>• Important possessions gathered.</li> <li>• Canned food, cleaning supplies, and bottled water hoarded.</li> <li>• Staff staying home with families.</li> <li>• Staff asking for respiratory protection.</li> <li>• Children staying close to home/parents.</li> <li>• Low participation in camp activities.</li> <li>• Markets closed/limited.</li> <li>• People not going out at night.</li> <li>• People staying off the road.</li> </ul>
<p><b>Legend:</b></p> <p>CBRN            chemical, biological, radiological, and nuclear</p> <p>IPE             individual protective equipment</p> <p>MTF            medical treatment facility</p>	



**This page intentionally left blank.**

## Appendix E

# Operational Environment

This appendix provides an overview of the OE. It introduces the operational variables of PMESII/PMESII-PT that provide relevant information for use by CBRN staffs, units, and individuals at the tactical level. The DOD defines an *operational environment* as a composite of the conditions, circumstances, and influences that affect the employment of capabilities and bear on the decisions of the commander. (See JP 3-0.)

### **POLITICAL, MILITARY, ECONOMIC, SOCIAL, INFORMATION, AND INFRASTRUCTURE AND MISSION ENEMY, TERRAIN AND WEATHER, TROOPS AND SUPPORT AVAILABLE, AND TIME AVAILABLE**

E-1. The complex framework in which the United States views the adversary and the adversary views the United States is an OE consisting of PMESII/PMESII-PT variables. The joint systems approach described in JP 3-0 is only valid for joint force campaign planning; however, understanding the PMESII/PMESII-PT variables enables commanders, CBRN staffs, and unit leaders to visualize an OE beyond the traditional military paradigms. The PMESII/PMESII-PT variables provide a framework for understanding, characterizing, and managing CBRN threats and hazards in a specific OE; assessing actions needed to determine the range of possible CBRN effects; and planning chemical, biological, radiological, and nuclear defense (CBRND) and vulnerability reduction measures encompassing various lines of operation to achieve tactical objectives.

E-2. Vertical and horizontal SA increases the understanding of an OE, providing the basis for decisionmaking. It ensures an adequate understanding of oneself, the enemy, the terrain, and other aspects of the OE.

E-3. During mission analysis at the tactical level, METT-TC/METT-T analysis methodologies focus more narrowly on the mission, enemy, troops, time, terrain, and civil considerations. Tactical-level responsibilities and execution enable the force to survive, fight, and win under CBRN conditions.

E-4. Commanders will use the conditions of their OE as planning considerations for inclusion in tactical-level plans and exercises. The tactical setting for U.S. military operations is a diverse and complex OE that includes the PMESII/PMESII-PT variables.

E-5. The elements and the attributes of the PMESII/PMESII-PT systems, tactically translated into METT-TC/METT-T domains, collectively form the basis for the complete OE, including friendly and enemy forces and other actors or elements that have been identified and selected for representation in the operational cycle of planning, preparation, execution, and assessment. Incorporating relevant information from the analysis of the variables into METT-TC/METT-T emphasizes OE human aspects, most obviously in civil considerations, but in the other factors as well. This requires critical thinking, collaboration, continuous learning, and adaptation.

### **POLITICAL, MILITARY, ECONOMIC, SOCIAL, INFORMATION, INFRASTRUCTURE, PHYSICAL ENVIRONMENT, AND TIME VARIABLES**

E-6. Consideration of the variables of PMESII/PMESII-PT can lead to the identification of key CBRN nodes, links, and vulnerabilities. When the adversary is a state, all of these variables will be present, with many of them possessing tangible infrastructure that is easily identified by ISR. When the adversary is a

nonstate actor, these same variables will be present to varying degrees, but the nature of the variables may be quite different. Nonstate actors are organized in a fundamentally different way than states, and they manifest themselves in completely different ways. However, the utility of the PMESII/PMESII-PT construct remains, even when the adversary is a nonstate actor. For deterrence, the political, psychological, and economic characteristics of an OE assume increased importance at the operational and tactical levels. For example, on the political scale, if an adversary has possessed CBRN weapons during past crises, it becomes important to understand the effect of those weapons on region politics and their effects on the decision to use or withhold such weapons.

## **POLITICAL**

E-7. The political environment addresses political decisions made during the conduct of military operations and their strategic, operational, and tactical implications. Likewise, the impact of each strategic, operational, and tactical action directly or indirectly affects the political variables of an OE. On the psychological scale, it is vital to understand adversary motivations and values to estimate the pressure that the adversary might feel to use or withhold CBRN weapons in a particular situation. Political, psychological, and economic considerations that influence deterrence may be the dominant factors influencing the adversary COAs.

### **National/Strategic Considerations**

E-8. U.S. military forces do not function independent of political policy and the desires of the people; they reflect the national values and obey the laws. Therefore, the U.S. military must have skills and programs for environmental protection. At this level, adversary analysis of strategic capabilities will concentrate on considerations (psychology of political leadership, national will and morale, ability of the economy to sustain warfare, possible willingness to use CBRN weapons, possible intervention by third-party countries and nonstate groups).

### **Operational/Tactical Considerations**

E-9. Warfighters must be prepared to operate and respond across the full spectrum of military operations and activities, to include homeland defense. From combat to humanitarian operations (in the four operational categories of offense, defense, stability, and support) the CBRND planner must be able to recommend—to the combatant, joint task force (JTF), or unit commander—measures that conform to environmental protection requirements—without impairing combat effectiveness. U.S. forces will increasingly operate in or near urban and populated environments. They must be able to execute combat operations; apply protection measures appropriate to the situation; and conform to laws, regulations, and international agreements.

### **Other Considerations**

E-10. The political structure is an overlay of formal and informal organizations. Other factors (treaties, international law, the capability of adversary propaganda to influence U.S. public support, world opinion) are also addressed. Determine the following:

- Is the threat force a treaty or agreement signatory?
- Are there significant moral or religious sanctions for or against the use of CBRN weapons by the threat force?

## **MILITARY**

E-11. The military variable looks at essential aspects of the OE (armed forces, security forces, insurgent groups, paramilitary organizations, criminal groups). It includes an analysis of the specific AO in terms of military objectives; avenues of approach; and the effects of a CBRN environment on personnel, military operations, weapons systems, and force mobility.

E-12. Munitions are increasingly lethal, and target acquisition systems are more precise. The proliferation of CBRN weapon systems requires the commander to integrate the capabilities of highly modernized organizations with less-modernized and multinational units.

E-13. Commanders must also realize that they do not have a monopoly on advanced technology. Even adversaries lacking research and development programs can purchase sophisticated systems in the global marketplace and gain selected parity or superiority to U.S. systems. Determine the following:

- What is the tactical-level assessment of the military adversary in terms of capability, disposition, tactics, and training status?
- What tactical units or factional groups could interfere with mission accomplishment?
- What is the size and location of the AO?
- What is the physical location of adversary land, air, naval, space, and other forces that could pose a direct threat to the security of the friendly force or the success of its mission?
- What types of CBRN weapons, obscurants, and delivery means do the threat forces possess?
- What are the minimum and maximum ranges of the various threat force delivery systems?
- Where are the TIMs located, and how might the threat forces employ them?
- Where are the units that possess the delivery systems located, and where are their command posts and communications nodes?
- What types of CBRN protection and detection equipment does the threat force have?
- What type of CBRN protective posture does the threat force exhibit?
- Is threat force CBRN weapon employment terrain-oriented, force-oriented, or a combination of both?
- What details are available regarding previous uses of CBRN weapons by the threat force—especially during recent operations?
- Are there probable employment indicators?
- What is the intent of the threat force? Is the threat force willing and able to operate in a contaminated environment?

## ECONOMIC

E-14. The economic variable looks at the formal economy, including production, distribution, consumption, labor force, and trade. Determine the following:

- What is the impact of trade outside the control of the government in goods and services, including illegal trade?
- What industrial and technological capabilities exist?
- Is the adversary interdependent within the nation or region?
- If social structure is an overlay of identity and affinity groups—
  - How do members of this society construct their identities?
  - Do the threat forces have allies that might enhance their capabilities or trading partners that might sell weapons to them?
  - Do the threat forces have a history of CBRN use?

## INFORMATION

E-15. The information environment includes information derived from nongovernmental individuals and organizations (the media) that produce and disseminate information that affects public opinion and can alter the conduct and perceived legitimacy of military operations.

E-16. ISR, IM, psychological operations, and information operations provide a common framework for determining how to plan, task, and control assets; how and where to report information; and how to use information.

E-17. Technology is a core capability that enables comprehensive situational understanding of CBRN threats and hazards and generates a strategic-to-tactical infosphere (a collection of interfaces, software tools, data, appliances, servers, and collaborators). Technology enhances leader, unit, and Service member ability to manage information and affects how forces plan, prepare, and execute operations in peace, conflict, and war. It has significantly increased our ability to conduct ISR operations, and it greatly enhances the ability to conduct battle command through modern telecommunications and microprocessing. Technology and technological systems provide supporting capabilities essential to implementing and continuously refining the CBRN threat assessment, including voice and data communications systems, IM systems (record keeping, resource tracking), and data display systems. Included are specialized technologies that facilitate ongoing operations and CBRN C2 activities in situations that call for unique technology-based capabilities.

E-18. Situational understanding is achieved by applying judgment, experience, expertise, and intuition; it allows the commander to understand the current state of friendly and enemy forces. Situational understanding includes the relationships among friendly and enemy forces and the variables of the OE that represent potential opportunities or threats for the warfighting unit. To maintain vertical and horizontal exchange of CBRN-related information, the commander and CBRN staff maintain constant SA and updates to the COP; therefore, intelligence assessments must be integrated among military, domestic, and foreign civil sources. (See table E-1 for examples of the required functional staff interfaces.)

**Table E-1. Functional staff interfaces**

<i>Information Environment</i>	<i>Description</i>
HR	<ul style="list-style-type: none"> <li>• The HR officer, medical officer, and CBRN staff assess the probability and impact of CBRN-related casualties and CBRN personnel readiness issues. This is especially critical when a majority of U.S. forces are reserve component members arriving in-theater at various times and are spread across warfighting functions.</li> <li>• The medical officer ensures that medical support is available in the event of a CBRN attack.</li> <li>• The CBRN staff checks with the personnel officer to determine the impact of CBRN casualties on the unit throughout operation phases.</li> </ul>
Intelligence	<ul style="list-style-type: none"> <li>• The CBRN staff works with the intelligence officer on weather and terrain data. They assess whether environmental factors are conducive to enemy use of CBRN weapons.</li> <li>• The intelligence section PIR address the enemy situation and the enemy ability to use CBRN weapons. The CBRN staff supports the intelligence section in the development of PIR.</li> <li>• The CBRN staff assists in the IPOE/IPB process for operation phases—determining and/or evaluating enemy capabilities, types of agents, types of obscurants and sensors, protective posture, line-of-sight influences on direct fire, and friendly vulnerabilities to enemy strengths.</li> <li>• The intelligence section provides information on enemy vulnerability to friendly operations (OBS).</li> </ul>
Operations	<ul style="list-style-type: none"> <li>• The CBRN staff recommends proper MOPP guidance, troop safety criteria, and the OEG. The staff also recommends priorities for the use of limited CBRND resources to the operations section through phases of operations.</li> <li>• The CBRN staff supports the operations staff by recommending task organizations for CBRN units and coordinating OBS, decontamination, and CBRN reconnaissance efforts.</li> <li>• The CBRN staff advises the commander on the impact of CBRN-related attacks on the current and future CONOPS. They provide input to the commander on hazard predictions, vulnerability, control of CBRN units, and mitigating techniques; and they recommend priorities for actions (decontamination, CBRN reconnaissance support, CDE resupply).</li> <li>• The CBRN staff provides recommendations on CBRN reconnaissance, decontamination, and OBS unit employment.</li> </ul>

Table E-1. Functional staff interfaces (continued)

<i>Information Environment</i>	<i>Description</i>
Logistics	<ul style="list-style-type: none"> <li>• The CBRN staff must coordinate with the logistics section concerning MOPP gear, decontaminants, and resupply requirements throughout phases of operations.</li> <li>• The logistics section and CBRN staff must know the rate and extent of the unit decontamination capability.</li> <li>• The logistics section and CBRN staff must plan to decontaminate contaminated supplies or equipment. In addition, the CBRN staff keeps the logistics section abreast of reported CBRN contamination to MSRs, critical supply facilities, and maintenance facilities that affect unit sustainability.</li> <li>• The CBRN staff advises the logistics section on ways to limit the need for the decontamination of supplies, which includes the use of disposable protective wraps or covers.</li> </ul>
CA	<ul style="list-style-type: none"> <li>• The CBRN staff works with the CA officer (USA, USMC, and USAF) on estimating the impact of CBRN events on the civilian population in the unit operational area. PSYOP are also considered when estimating the impact of CBRN events.</li> <li>• The CBRN staff coordinates with the CA section for the integration of HN assets into decontamination operations (field-expedient decontamination equipment and supplies [steam cleaners, bleach], fire trucks, wash racks).</li> <li>• The CBRN staff also considers the integration of field-expedient CBRN protective shelters (existing buildings in local population centers).</li> </ul>
Engineer (USA)	<ul style="list-style-type: none"> <li>• The CBRN staff works with the engineer staff to identify CBRN obstacles and plan for the use of OBS at river-crossing sites and obstacle breaching.</li> <li>• The CBRN staff coordinates engineer support for CBRN decontamination survivability operations and facility hardening.</li> </ul>
Air defense	<ul style="list-style-type: none"> <li>• The CBRN staff and air defense officer coordinate to exchange information on CBRND and chemical downwind hazards from an enemy CBRN attack.</li> <li>• The CBRN staff coordinates the integration of the theater missile defense warning system into the commander's passive-defense strategy.</li> </ul>
Fire support	<ul style="list-style-type: none"> <li>• As required, the CBRN staff and force commander coordinate during the targeting process. Target considerations will affect mission planning for the correct force mixture to deliver the right weapon to defeat adversary CBRN capability with minimum collateral effects.</li> <li>• Prior to target nomination and selection, coordination addresses the type of enemy CBRN agents, their containment within facilities and vehicles, their proximity to population centers, and adversary active and passive defenses.</li> <li>• The law of armed conflict and its relation to noncombatants and friendly forces provides key targeting guidance.</li> <li>• Target planning also requires knowledge of the types of agents, disposition, location, storage, employment area, and demographics to effectively predict collateral effects.</li> <li>• Automated planning tools provide target modeling that assists decisions regarding the risks associated with collateral effects.</li> </ul>

Table E-1. Functional staff interfaces (continued)

<i>Information Environment</i>	<i>Description</i>																																														
Security	<ul style="list-style-type: none"> <li>• The CBRN staff, military law enforcement officer, and FP officer coordinate and exchange needed information on CBRND, especially data on CBRN identification, detection, and warning.</li> <li>• Timely information exchange on CBRND is especially important for land force movement in the AO. Personnel at traffic control points should be well informed on contamination locations.</li> </ul>																																														
Medical/HSS	<ul style="list-style-type: none"> <li>• The command surgeon advises the commander on the health effects of CBRN and TIM agents and the medical effects of immunizations, pretreatments, chemoprophylaxis, and treatment.</li> <li>• Environmental sampling of the air, water, and soil must occur to provide input into the quantitative health risk assessment and the commander's composite risk assessment.</li> <li>• The HSS staff provides recommendations on associated concerns (heat stress and psychological effects of CBRN weapons use). The plans help to ensure that required HSS is available in the event of a CBRN attack.</li> <li>• The HSS staff also oversees the PVNTMED mission, which includes the establishment of laboratories to handle CBRN sample analyses and ensures that PVNTMED services are provided to the commander.</li> <li>• The HSS staff ensures casualty treatment, and PVNTMED personnel coordinate plans with CBRND personnel.</li> <li>• The medical staff provides medical guidance on the establishment of radiation exposure levels.</li> </ul>																																														
Public affairs	<ul style="list-style-type: none"> <li>• The public affairs portion is crucial to the success of the overall operation. We can win the battle and lose the war of public opinion.</li> <li>• Information addresses the ability to influence groups or populations through direct or indirect action.</li> <li>• The ability to influence various audiences.</li> <li>• The required resources in terms of knowledge, expertise, tools, and money.</li> </ul>																																														
<p><b>Legend:</b></p> <table border="0"> <tr><td>AO</td><td>area of operations</td></tr> <tr><td>CA</td><td>civil affairs</td></tr> <tr><td>CBRN</td><td>chemical, biological, radiological, and nuclear</td></tr> <tr><td>CBRND</td><td>chemical, biological, radiological, and nuclear defense</td></tr> <tr><td>CDE</td><td>Centers for Disease Control and Prevention</td></tr> <tr><td>CONOPS</td><td>concept of operations</td></tr> <tr><td>FP</td><td>force protection</td></tr> <tr><td>HN</td><td>host nation</td></tr> <tr><td>HR</td><td>human resources</td></tr> <tr><td>HSS</td><td>health service support</td></tr> <tr><td>IPB</td><td>intelligence preparation of the battlefield</td></tr> <tr><td>IPOE</td><td>intelligence preparation of the operational environment</td></tr> <tr><td>MOPP</td><td>mission-oriented protective posture</td></tr> <tr><td>MSR</td><td>main supply route</td></tr> <tr><td>OBS</td><td>obscuration</td></tr> <tr><td>OEG</td><td>operational exposure guide</td></tr> <tr><td>PIR</td><td>priority information requirements</td></tr> <tr><td>PSYOP</td><td>psychological operations</td></tr> <tr><td>PVNTMED</td><td>preventive medicine</td></tr> <tr><td>TIM</td><td>toxic industrial material</td></tr> <tr><td>USA</td><td>U.S. Army</td></tr> <tr><td>USAF</td><td>U.S. Air Force</td></tr> <tr><td>USMC</td><td>U.S. Marine Corps</td></tr> </table>		AO	area of operations	CA	civil affairs	CBRN	chemical, biological, radiological, and nuclear	CBRND	chemical, biological, radiological, and nuclear defense	CDE	Centers for Disease Control and Prevention	CONOPS	concept of operations	FP	force protection	HN	host nation	HR	human resources	HSS	health service support	IPB	intelligence preparation of the battlefield	IPOE	intelligence preparation of the operational environment	MOPP	mission-oriented protective posture	MSR	main supply route	OBS	obscuration	OEG	operational exposure guide	PIR	priority information requirements	PSYOP	psychological operations	PVNTMED	preventive medicine	TIM	toxic industrial material	USA	U.S. Army	USAF	U.S. Air Force	USMC	U.S. Marine Corps
AO	area of operations																																														
CA	civil affairs																																														
CBRN	chemical, biological, radiological, and nuclear																																														
CBRND	chemical, biological, radiological, and nuclear defense																																														
CDE	Centers for Disease Control and Prevention																																														
CONOPS	concept of operations																																														
FP	force protection																																														
HN	host nation																																														
HR	human resources																																														
HSS	health service support																																														
IPB	intelligence preparation of the battlefield																																														
IPOE	intelligence preparation of the operational environment																																														
MOPP	mission-oriented protective posture																																														
MSR	main supply route																																														
OBS	obscuration																																														
OEG	operational exposure guide																																														
PIR	priority information requirements																																														
PSYOP	psychological operations																																														
PVNTMED	preventive medicine																																														
TIM	toxic industrial material																																														
USA	U.S. Army																																														
USAF	U.S. Air Force																																														
USMC	U.S. Marine Corps																																														



## INFRASTRUCTURE

E-19. The infrastructure is more than just a collection of physical assets. The importance of the individual or collective assets is drawn from the situation and their relationship to the other PMESII/PMESII-PT variables. Determine the following:

- What are the potential accidental-release hazards from local activities (industrial pipelines, storage, and shipping facilities)?
- Does the infrastructure network operate efficiently, or is it cumbersome?
- Are there industrial chemical plants or nuclear-power facilities that may be targeted by threat forces?
- What is the civil response capability of hospitals, clinics, and medical treatment facilities to handle patients from a CBRN incident?
- Are facilities and water sources available to support decontamination operations?

## PHYSICAL ENVIRONMENT

E-20. JP 3-0 defines the physical environment as land, maritime, air, and space domains. Humans live, breathe, and walk in the physical environment; and they see, hear, and touch objects that are real. The physical environment includes weather, terrain, geography, and man-made structures within the operational area. The enemy understands the effects of CBRN agents on weather and terrain; therefore, they may try to counteract U.S. military advantages by using CBRN agents during favorable weather conditions to deny operational uses of urban or other essential terrain. Weather and terrain effects must be continuously assessed so that decision support tools and predictive modeling capabilities can integrate environmental conditions. (See table E-2 for more information on physical-environment variables.)

**Table E-2. Physical-environment variables**

<i>Physical Environment</i>	<i>Description</i>
Weather considerations	<p>Detailed weather information must be obtained to determine its effects on the employment of CBRN weapons and materials. Examples include, but are not limited to—</p> <ul style="list-style-type: none"> <li>● Thermometer readings to estimate the effect of temperature on agent duration.</li> <li>● Data regarding wind speed and direction for hazard and OBS prediction.</li> <li>● Information about atmospheric conditions (humidity, air stability) to determine their influence on the use of obscurants.</li> <li>● The effect weather will have on the employment of CBRN weapons.</li> <li>● Weather effects on the behavior of CBRN threats and hazards.</li> <li>● Weather will be favorable or unfavorable for the use of CBRN weapons during the next 72 hours.</li> </ul>
Terrain considerations	<p>The CBRN staff identifies critical terrain that must be avoided, actively protected, or exploited temporarily to accomplish the mission; fixed facilities, structures, or other real property required by operations for logistics, C2, administration, communications, billeting, base camp, or other mission purposes; and potential enemy CBRN targets or NAIs and plan contingency responses. The analysis should concentrate on characteristics that impact operations, to include—</p> <ul style="list-style-type: none"> <li>● Capability of road, rail, air, and sea transportation networks to support the movement of, and logistics support to, CBRN weapons.</li> <li>● Zones of entry into and through the operational area and AOI.</li> <li>● Operational impact of large geographic features (mountains, large forests, deserts, archipelagos).</li> <li>● Impact of seasonal climate on CBRN weapon effects.</li> <li>● Water supply and source.</li> <li>● Soil type and land cover.</li> </ul>

**Table E-2. Physical-environment variables (continued)**

<i>Physical Environment</i>	<i>Description</i>
Terrain considerations (continued)	<ul style="list-style-type: none"> <li>• Property description and condition.</li> <li>• Topographic, hydrologic, and geologic features.</li> <li>• Presence of industrial storage facilities and tanks.</li> <li>• Effect of the terrain on CBRN weapons.</li> <li>• Location where CBRN weapon use will cause the most problems for the operation.</li> <li>• Effects of CBRN agents in open terrain.</li> <li>• Effects of CBRN agents in heavily vegetated areas.</li> <li>• Effects of CBRN agents in urban terrain.</li> <li>• Location of critical terrain features (defiles, choke points, rivers, high ground).</li> <li>• Degree of natural protection available for cover and concealment.</li> <li>• Location of water sources and areas suitable for equipment decontamination.</li> </ul>
Geographic framework	<p>Geographic factors normally require consideration during the operations process; however, foreign nations or regions in which U.S. forces operate may have additional protection requirements, to include—</p> <ul style="list-style-type: none"> <li>• Topography and soils.</li> <li>• Vegetation, including crops.</li> <li>• Air quality.</li> <li>• Wildlife and livestock.</li> <li>• Archaeological and historical sites.</li> <li>• Safety and public health.</li> <li>• Criteria for land and facility use, occupation, and return.</li> <li>• Water quality, including surface water, groundwater, storm water, and wetlands.</li> <li>• Hazardous materials, waste disposal, potential cleanup requirements, to include decontaminants, contaminated materials, human waste, solid waste, and biological and biomedical waste.</li> </ul>
Man-made structures	<p>Particularly urban environments, which include supersurface, surface, and subsurface features, to include—</p> <ul style="list-style-type: none"> <li>• Climate and weather.</li> <li>• Topography.</li> <li>• Hydrology.</li> <li>• Natural resources.</li> <li>• Biological features and hazards.</li> <li>• Other environmental conditions.</li> </ul>
<p><b>Legend:</b></p> <p>AOI            area of interest  C2             command and control  CBRN         chemical, biological, radiological, and nuclear  NAI            named area of interest  OBS            obscuration</p>	

**TIME**

E-21. Time is a significant consideration in military operations. The analysis of time as an operational variable focuses on the benefits and liabilities of the duration of operations to each side. CBRN threats and hazards have implications at every level of planning. Some enemies view protracted conflict as advantageous to them. They may focus on surviving and inflicting friendly and civilian CBRN casualties over time. This creates opportunities to affect the way that the CBRN weapon usage is viewed by domestic

and international audiences. Essentially, today's enemies wage conflict in the information environment as much as, or more than, the physical domains.

## **MISSION, ENEMY, TERRAIN AND WEATHER, TROOPS AND SUPPORT AVAILABLE, TIME AVAILABLE, AND CIVIL CONSIDERATIONS VARIABLES**

E-22. Upon receipt of a warning order or mission, leaders narrow their focus to METT-TC/METT-T variables. These variables describe the relevant information for a given mission and form the framework for mission analysis. Relevant information is all information of importance to commanders and staffs in the exercise of C2. (See FM 3-0 for more information.) Leaders use METT-TC/METT-T to synthesize operational- and tactical-level information with local knowledge relevant to their mission.

---

*Note.* The USMC uses the acronym METT-T. Civilian considerations are inherently measured within the context of this acronym.

---

### **MISSION**

E-23. The nature of the tactical mission may imply specific CBRN threats and hazards. Some missions are inherently more dangerous than others. Leaders look for hazards associated with the complexity of higher headquarters plans and orders (a particularly complex scheme of maneuver). The use of a fragmentary order in lieu of a detailed operation order or operation plan also may raise the risk due to the possibility of misunderstanding.

### **ENEMY**

E-24. The AO is influenced by the physical location of adversary land, air, naval, space, and other forces that could pose a direct threat to the security of the friendly force or the success of its mission. It is important that enemy unit type, composition, disposition, capabilities, and intent are well understood. Commanders look for enemy presence or CBRN capabilities that pose hazards to the operation or mission.

### **TERRAIN AND WEATHER**

E-25. The factors of observation and fields of fire, avenues of approach, key and decisive terrain, obstacles, and cover and concealment are used to identify and assess the CBRN threats and hazards impacting mission-type operations. Terrain should always be addressed when planning a tactical mission, and leaders should also assess weather conditions for mission and nonmission activities:

- **Terrain.** Common terrain factors are elevation, altitude, road surfaces, curves, grades, and traffic density.
- **Weather.** Common weather factors are cold, ice, snow, rain, fog, heat, humidity, wind, dust, visibility, and illumination.

---

*Note.* See *Potential Military Chemical/Biological Agents and Compounds* for additional information on the effects of terrain and weather on the dispersion of CBRN agents and materials.

---

### **TROOPS AND SUPPORT AVAILABLE**

E-26. Troops and support considerations CBRN threats and hazards that are associated with the level of training, staffing, equipment, and equipment maintenance and condition. They also include morale, availability of supplies and services, and the physical and emotional health of the warfighter.

E-27. U.S. forces should deploy with CBRND equipment in the unit load. Personnel should carry the overgarments in their CBRN bag or wear the overgarments. This will depend on the CBRN threat to the airfield or port on which they land. Personnel should change protective mask filters before deployment. Decontamination and CBRN reconnaissance assets should be task-organized and moved forward.

Contingency stocks of CBRND equipment, including medical countermeasures, may be moved forward to the battalion trains. Chemical downwind messages/effective downwind messages are initiated, and collective-protection systems are placed into a state of readiness, including those systems in combat vehicles.

E-28. U.S. forces may not have to carry CBRND equipment (individual protective equipment) based on the initial threat estimate. If the threat conditions were to change and indicators were present to suggest the possible use of CBRN agents by threat forces, CBRND equipment would be deployed forward (division, brigade support area). These stocks may be prepalletized for immediate deployment by aircraft to the affected unit, if required. However, this decision must be made based on available aircraft or other transportation systems. This could be done so that the forces would not have to carry the MOPP ensemble in their field packs or CBRN bags.

**TIME AVAILABLE**

E-29. Insufficient time for mission preparation often forces commanders to accept greater risk in the planning, preparation, and execution of plans and orders associated with mission planning. To avoid or mitigate the risk associated with inadequate time for planning, leaders should allow subordinates two-thirds of the available planning time as a control. For nonmission activities, insufficient time is usually due to haste rather than availability.

**CIVIL CONSIDERATIONS**

E-30. This function expands the consideration of CBRN threats and hazards to include those hazards that a tactical mission may pose to the civilian population and noncombatants in the AO. The objective is to reduce the amount of collateral damage to civilians and noncombatants. CBRN hazards are also created by the presence of a large civilian population and their efforts to conduct day-to-day activities during the course of a mission. High civilian traffic densities may present hazards to convoys and maneuver schemes. Such diverse elements as insurgencies, riots, and criminal activity must also be assessed.

E-31. For nonmission activities, the term “legal” is used to address those legal, regulatory, or policy considerations that may impact a desired activity or limit a leader’s or an individual’s COA.

**WEATHER AND TERRAIN EFFECTS ON CHEMICAL, BIOLOGICAL, RADIOLOGICAL, AND NUCLEAR THREATS AND HAZARDS**

E-32. Weather and terrain can affect CBRN hazards in various ways. They may prolong the agent’s presence in the AO or shorten the time that agents pose a hazard to the warfighter. By knowing how weather and terrain affect CBRN weapons, threats, and hazards, commanders, leaders, and staffs can plan CBRN vulnerability reduction measures. (See *Potential Military Chemical/Biological Agents and Compounds* for detailed information and technical data on CB agents and other compounds of military interest, including their uses; classification; and physical, chemical, and physiological properties.)

**CHEMICAL HAZARDS**

E-33. Adversaries will seek to employ chemical agents under favorable weather conditions, if possible, to increase their effectiveness. Considerations of weather effects also influence commander’s decisions and the CBRN staff recommendations for threat conditions. (See table E-3 for weather effects on aerosol chemical agents.)

**Table E-3. Weather effects on aerosol chemical agents**

<i>Factors</i>	<i>Wind (kph)</i>	<i>Air Stability</i>	<i>Temperature</i>	<i>Humidity</i>	<i>Precipitation</i>
Favorable	Steady <5	Stable	>21	>60	None
Moderate	Steady 5–13	Neutral	4–21	40–60	Light
Unfavorable	>13	Unstable	<4	<40	Any
<b>Legend:</b> kph                      kilometers per hour					

E-34. The following are weather effects on chemical hazards:

- **Atmospheric stability.** One of the key factors in using chemical weapons is the determination of the atmospheric stability condition that will exist at the time of attack. This determination can be made from a meteorological report or by observing field conditions as follows:
  - **Unstable conditions.** Unstable conditions (many rising and falling air currents, great turbulence) quickly disperse chemical agents. Unstable is the least favorable condition for chemical agent use because it results in a lower concentration, thereby reducing the area affected by the agent. Many more munitions are required to attain the commander's objectives under unstable conditions than under stable or neutral conditions.
  - **Stable conditions.** Stable conditions (low wind speeds, slight turbulence) produce the highest concentrations. Chemical agents remain near the ground and may travel for long distances before being dissipated. Stable conditions encourage the agent cloud to remain intact, thus allowing it to cover extremely large areas without diffusion. However, the direction and extent of cloud travel under stable conditions are not predictable if dependable local wind data is not available. A very stable condition is the most favorable condition for achieving a high concentration from a chemical cloud being dispersed.
  - **Neutral conditions.** Neutral conditions are moderately favorable. With low wind speed and smooth terrain, large areas may be effectively covered. The neutral condition occurs at dawn and sunset and, generally, is the most predictable. For this reason, a neutral dispersion category is often best from a military standpoint.
- **Vapor concentration and diffusion.** Agent concentration is governed by the volume of the agent cloud. Since clouds continually expand, agent concentration levels decrease over time. Wind speed determines the downwind growth of the cloud. Vertical and horizontal turbulence determines the height and width of the cloud. The rate at which the downwind, vertical, and horizontal components expand governs the cloud volume and the agent concentration. To be effective at a specific concentration level, the agent cloud must remain in the target area for a definite period. Wind in the target area mixes the agent and distributes it over the target after release. For ground targets, high concentrations and good coverage can best be achieved with low turbulence and calm winds when the agent is delivered directly on target. A steady, predictable wind drift over the target is best when the agent is delivered on the upwind side of the target. Conditions other than these tend to produce lower concentrations and poorer target coverage. However, unless the weather conditions are known within the target area, the effects of the agent on the target will be approximations. The concentration and diffusion of a chemical-agent cloud are also influenced by the following:
  - **Hydrolysis.** Hydrolysis is a process in which (chemical) compounds decompose and split into other compounds by taking up the elements of water. Chemical agents with high hydrolysis rates are less effective under high-humidity conditions.
  - **Absorption and adsorption.** Absorption is the process by which an agent is taken into the vegetation, skin, soil, or material. Adsorption is adding a thin layer of agent to vegetation or other surfaces. This is important in dense vegetation. Absorption and adsorption of chemical agents may kill vegetation, thus defoliating the area of employment.
  - **Meandering.** When a chemical cloud is released into the air, shifting air currents and horizontal turbulence blow it from side to side. The side-to-side motion of the air is called *meandering*. While the agent cloud meanders, it also spreads laterally. Lateral spreading is called *lateral diffusion*. In more unstable conditions, the lateral spread tends to be greater than in stable conditions.
  - **Drag.** Wind currents carry chemical clouds along the ground with a rolling motion. This is caused by the differences in wind velocity. Wind speeds increase rapidly from near zero at the ground to higher speeds at higher elevations above the ground. The drag effect by the ground, together with the interference of vegetation and other ground objects, causes the base of an agent cloud to be impeded as the cloud stretches out in length. When clouds are released on the ground, the drag amounts to about ten percent of the vertical growth over distance traveled over grass, plowed land, or water. It amounts to about 20 percent over

gently rolling terrain covered with bushes, growing crops, or small patches of scattered timber. In heavy woods, the drag effect is greatly increased.

- **Wind shear.** Wind speeds can vary at different heights. The wind direction can also change with an increase in height; this is known as *wind shear*. Because of wind shear, a puff (or chemical cloud) may become stretched in the downwind direction and may travel in a direction different from that of the surface wind. Additionally, a chemical cloud released in the air may be carried along faster than it can diffuse downward. As a result, air near the ground on the forward edge of the cloud may be uncontaminated, while the air a few feet up may be heavily contaminated. This layering effect becomes more pronounced and increases proportionately with the distance of the forward edge of the cloud from the source.
- **Density.** Density is the mass found in a volume of gas, liquid, or solid. Since atoms and molecules weigh something (have mass), the more of them packed into a given space, the greater the density. The vertical rise of a chemical cloud depends on the weather variables (temperature gradient, wind speed, turbulence) and the difference between the densities of the clouds and the surrounding air. As mentioned earlier, the temperature of the cloud and the air influences their relative densities. Hotter gases are less dense and lighter than cooler gases and air. Therefore, they rise until they are mixed and somewhat diluted and attain the same temperature and approximately the same density as the surrounding air. The vapor cloud formed by an agent normally employed for a persistent effect rises in a similar manner, but vapor concentrations build up more gradually.
- **Wind.** High wind speeds cause a rapid dispersion of vapors or aerosols, thereby decreasing the effective coverage of the target area and time of exposure to the agent. In high winds, larger quantities of munitions are required to ensure effective concentrations. Agent clouds are most effective when wind speeds are less than 4 knots and steady in direction. The clouds move with the prevailing wind as altered by terrain and vegetation. Steady, low wind (speeds of three to seven knots) enhances the coverage area unless an unstable condition exists. With high winds, chemical agents cannot be economically employed to achieve casualties. The evaporation of liquid agents due to wind speed depends on the amount of the liquid exposed to the wind (the surface of the liquid) and the rate that the air passes over the agent. Therefore, the duration of effectiveness is longer at places of greater liquid agent contamination and in places where the liquid agent is sheltered from the wind. The rate of evaporation of agents employed for persistent effect in a liquid state is proportional to the wind speed. If the speed increases, evaporation increases, thus shortening the duration of the effective contamination. Increased evaporation creates a larger vapor cloud. The vapor cloud is dispersed by higher winds.
- **Temperature.** Vaporization increases with higher temperatures. Also, the rate of evaporation of remaining liquid agent from an exploding munition can vary with the temperature.
- **Humidity.** Humidity has little effect on most chemical-agent clouds. Some agents (phosgene and lewisite) hydrolyze quite readily. Hydrolysis causes these chemical agents to break down and change their chemical characteristics. High humidity combined with high temperatures may increase the effectiveness of some agents due to body perspiration-absorbing agents and allow for better transfer.
- **Precipitation.** Precipitation can dilute and disperse chemical hazards, but can spread contamination.

## BIOLOGICAL HAZARDS

E-35. The following are weather effects on biological hazards:

- **Air stability.** The effects of temperature gradients on biological agents are similar to those on chemical agents. However, temperature gradients have less effect on a biological-agent cloud than a chemical-agent cloud because biological agents are effective in lower concentrations than chemical agents. A stable atmosphere (inversion) produces the greatest effects. Under unstable (lapse) and neutral conditions, greater atmospheric mixing reduces cloud concentration, but concentration is still sufficient to inflict casualties. Predictions of these effects require specific knowledge of the agent and its potential carriers. (See table E-4 for information on how weather affects biological-agent dissemination [see JP 3-11].)



Table E-4. Weather effects on biological-agent dissemination

<i>Weather Conditions</i>	<i>Cloud Performance</i>	<i>Operational Considerations</i>
Favorable stable or inversion conditions	Agent clouds travel downwind for long distances before they spread laterally. High humidity and light rains generally favor wet-agent dissemination.	Agent clouds tend to dissipate uniformly and remain cohesive as they travel downwind. Clouds lie low to the ground and may not rise high enough to cover the tops of tall buildings or other tall objects.
Marginal neutral conditions	Agent clouds tend to dissipate quickly.	More agent is required for the same result as those in stable conditions. Desired results may not be achieved.
Unfavorable unstable or lapse conditions	Agent clouds rise rapidly and do not travel downwind appreciable distance. Cloud temperatures affect wet dissemination.	Agent clouds tend to break up and become diffused. There is little operational benefit from off-target dissemination.

- **Temperature.** Air temperature in the surface boundary layer is related to the amount of sunlight that the ground has received. Normal atmospheric temperatures have little direct effect on the microorganisms of a biological aerosol. Indirectly, however, an increase in the evaporation rate of the aerosol droplets normally follows a temperature increase. There is evidence that the survival of most pathogens decreases sharply in the range of -20°C to -40°C and above 49°C. High temperatures kill most bacteria, viral, and rickettsial agents. However, these temperatures will seldom be encountered under natural conditions. Subfreezing temperatures tend to quick-freeze the aerosol after its release, thus decreasing the rate of decay. Ultraviolet light (one form of the radiation from the sun) has a destructive effect on the biological aerosol because exposure to ultraviolet light increases the decay rate of microorganisms. Most toxins are more stable than pathogens and less susceptible to the influence of temperature.
- **Relative humidity.** The relative humidity level favoring the employment of a biological-agent aerosol depends on whether the aerosol is distributed wet or dry. For a wet aerosol, a high relative humidity retards the evaporation of tiny droplets containing microorganisms. This decreases the decay rate of wet agents, as drying results in the death of these microorganisms. A low relative humidity is favorable for the employment of dry agents. When the humidity is high, the additional moisture in the air may increase the decay rate of the microorganisms of dry aerosol. This is because moisture speeds up the life cycle of the microorganisms. Most toxins are more stable than pathogens and are less susceptible to the influence of relative humidity.
- **Pollutants.** Atmospheric pollutant gases have been found to decrease the survival of many pathogens. These gases include nitrogen dioxide, sulfur dioxide, ozone, and carbon monoxide. This could be a significant factor on an AO over which the air is often polluted.
- **Cloud coverage.** Cloud coverage in an area influences the amount of solar radiation received by the aerosol because clouds decrease the amount of destructive ultraviolet light that the microorganisms receive. Cloud coverage also influences other factors (ground temperature, relative humidity).
- **Precipitation.** Precipitation may wash suspended particles from the air. This washout may be significant in a heavy rainstorm, but minimal at other times. High relative humidity associated with mist, drizzle, or very light rain is also an important factor. This may be favorable or unfavorable, depending on the type of agent. The low temperatures associated with ice, snow, and other winter precipitation prolongs the life of most biological agents.
- **Sunlight.** Most biological pathogens and some toxins are affected by ultraviolet rays in sunlight. Therefore, most attacks will likely occur at night, during extended twilight, or during overcast conditions. Pathogens may be encapsulated (enclosed in a natural or man-made protective covering) or genetically engineered to increase resistance to direct sunlight. Thus, agents delivered during conditions of direct sunlight or after morning nautical twilight should be a sunlight-resistant agent.



- **Wind.** High wind speeds increase the area covered by biological agents, but they also dilute the agent, thereby lowering the casualty percentages within an area. Most biological warfare attacks occur under conditions of moderate wind speed because the most effective wind speeds for target coverage are 12 to 30 kilometers per hour. As the agent cloud travels downwind, it gradually loses its effectiveness due to dilution caused by agent fallout, dispersal, and death of the pathogen agent or neutralization of the toxin. However, the downwind hazard areas of biological weapons will be much larger than those of chemical weapons because most biological agents are lighter and more potent (weight-to-effect basis) than chemical agents. If delivered directly on target, as with a bomblet attack, the wind direction and speed will have a more limited effect on coverage; however, downwind effects must still be considered. If dissemination occurs far upwind from the target area in a more elevated manner, downwind effects can be even more dramatic.

## RADIOLOGICAL AND NUCLEAR HAZARDS

E-36. Conditions that significantly affect the visibility or the transparency of the air also affect the transmission of thermal radiation. Clouds, obscuration (including artificial), fog, snow, and rain absorb and scatter thermal energy. Depending on the concentration, they can stop as much as 90 percent of the thermal energy. On the other hand, clouds above the burst may reflect additional thermal radiation onto the target that would have otherwise traveled harmlessly into the sky. The following are effects on radiological and nuclear hazards:

- **Precipitation.** Rain on an area contaminated by a surface burst changes the pattern of radioactive intensities by washing off higher elevations, buildings, equipment, and vegetation. This reduces intensities in some areas and possibly increases intensities in drainage systems, on low ground, and in flat or poorly drained areas. Rain and fog may lessen the blast wave because energy dissipates as it heats and evaporates the moisture in the atmosphere. Clouds and air density have no significant effects on fallout patterns. Precipitation scavenging, known as *rainout*, can cause the removal of radioactive particles from the atmosphere. Because of the uncertainties associated with weather predictions, the locations that could be affected by rainout cannot be accurately predicted. Rainout may occur near ground zero, or the contaminants could be carried aloft for tens of kilometers before deposition. Rainout is most likely to occur from a surface or subsurface burst. Vast quantities of radioactive debris will be carried aloft and deposited downwind. However, rainout may cause the fallout area to increase or decrease and also cause hot spots within the fallout area. For airbursts, rainout can increase the residual contamination hazard. Normally, the only residual hazard from an airburst is a small neutron-induced contamination area around ground zero. However, rainout will cause additional contaminated areas in unexpected locations. Yields of 10 kilotons or less present the greatest potential for rainout, and yields of 60 kilotons or more offer the least. Yields between 10 and 60 kilotons may produce rainout if the nuclear clouds remain at or below rain cloud height.
- **Wind speed and direction.** Wind speed and direction at various altitudes are two factors that determine the shape, size, location, and intensities of the fallout pattern on the ground, because contaminated dirt and debris deposit downwind. Surface winds also play an important role in the final location of the fallout particles. Local winds cause localization of fallout material in crevices and ditches and against curbs and ledges in the same manner that snow piles up in drifts. This effect is not locally predictable, but personnel must be aware of the probability that highly intense accumulations of radioactive material will occur at their natural locations.

## COLD-WEATHER EFFECTS ON CHEMICAL, BIOLOGICAL, RADIOLOGICAL, AND NUCLEAR HAZARDS

E-37. Cold-weather environments create diverse conditions that must be overcome to accomplish an assigned mission in a CBRN environment. The following paragraphs describe cold-weather effects on chemical, biological, radiological, and nuclear hazards:

- **Chemical.** In arctic conditions, chemical agents act differently, but they are primarily more persistent. Chemical agents include—
  - **Blister agents.** Some forms of blister agents are ineffective casualty producers when the ambient temperature is well below their normal freezing points. This is not true for all blister agents, some of which can be effective as harassing or casualty-producing agents.
  - **Nerve agents.** Low levels of contamination may remain at low temperatures for hours or days. In severely cold conditions, nerve agents will remain liquid and can be absorbed through normal, cold-weather clothing. However, agent data indicates that liquid absorption into soil and concrete is not significantly affected by temperature and that snow absorbs agents within minutes—to the point that less than 2 percent of the agent remained as a pickup/transfer hazard.
  - **Blood and choking agents.** Blood and choking agents remain extremely hazardous and nonpersistent throughout the low-temperature ranges.
- **Biological.** Biological warfare in the arctic is a possibility, and biological agents are effective in cold-weather environments (with few exceptions). However, most vectors (infected insects) will not survive the extreme environmental conditions, and it is more difficult to aerosolize live biological agents in freezing temperatures. Toxins, on the other hand, are less susceptible to the cold. At these temperatures, spore-forming bacteria and certain viruses survive and remain dormant. Upon warming, they become an active hazard to personnel. Temperature inversions that exist over snowfields tend to prolong the integrity of an aerosolized biological cloud. It disperses more slowly and remains a threat for a longer period.
- **Radiological and nuclear.** The winter environment influences the effects of a nuclear detonation regarding blast, thermal, and radiation effects as follows:
  - **Blast.** At subzero temperatures, the radius of damage to material targets can increase as much as 20 percent. Tundra, irregular terrain features, and broken ice caps will break up the pressure wave and reduce the effects of this powerful wave. Blast waves can drastically interfere with movement by breaking up ice covers and causing thaws, which can trigger avalanches in mountainous areas. Avoid avalanche-prone areas after the blast. Avalanches can be triggered up to 30 kilometers away and may cause massive flooding in valleys due to the instability caused by the blast effects.
  - **Thermal.** Ice and snow have a high reflectivity. This may increase the minimum safe distance as much as 50 percent for unwarned personnel. This reflectivity may increase the number of personnel whose vision is affected by the brilliant flash or light dazzle, especially at night. Cold temperatures reduce thermal effects on materials by reducing the possible heat signature. Snow, ice, and frost coverings on combustible materials greatly reduce the tendency of materials to catch fire. However, this thermal effect will dry out exposed tundra areas and grass fires may result. Again, avoid avalanche-prone areas after the blast. Avalanches can be triggered up to 30 kilometers away due to the rapid warming and instability caused by the thermal effects.
  - **Radiation.** The number of passable roadways is limited by cold-weather conditions, and radiological contamination on roadways may further restrict resupply and mobility. Seasonal high winds in the arctic may present problems when predicting radiological contamination and crossing contaminated areas. These winds may reduce dose rates at ground zero. At the same time, they extend the area coverage and create a problem for survey and monitoring teams. Hot spots or areas of concentrated accumulation of radiological contamination may also occur in the areas of heavy snow and snow drifts.

## DESERT EFFECTS ON CHEMICAL, BIOLOGICAL, RADIOLOGICAL, AND NUCLEAR HAZARDS

E-38. Desert daytime temperatures can vary from 90° to 125°F (32° to 52°C), creating an unstable temperature gradient that is not particularly favorable to CBRN attacks. However, with nightfall, the desert cools rapidly, resulting in a stable temperature gradient that increases the possibility of night or early morning attacks. Planners should understand that hot temperatures can adversely impact CBRND equipment/supplies during transit or storage. The following paragraphs describe desert effects on CBRN hazards:

- **Chemical.** Chemical agents can be used in point or on-target attacks. Chemical-agent attacks can be used at high temperatures because of rapid agent evaporation. For example, with a neutral temperature gradient (90°F [32°C]) and light wind, sarin evaporates rapidly. Desert soil may be very porous. If an attack with an unthickened liquid agent occurs in support of a predawn conventional attack, soil may absorb the agent. However, when the sun rises and begins to heat the surface, the agent may evaporate and create a vapor hazard. A nonpersistent agent attack is unlikely during daylight hours because weather conditions may rapidly dissipate agents. Night brings about a reversal of weather conditions and creates ideal conditions for an attack. At night, agents linger and settle into low areas (fighting positions).
- **Biological.** Most aerosolized, live biological agents are ineffective weapons in the high temperatures of desert areas. An exception is spore-forming biological agents. This is a result of low humidity and the ultraviolet radiation of direct sunlight. Personnel crossing or occupying desert terrain face little danger from long-term, live biological contamination except for spore-forming agents. However, a covert aerosolized attack could occur during more favorable night conditions. Toxins are resistant to this harsh environment and could be employed in the same way as chemical agents.
- **Radiological and nuclear.** Nuclear defense planning is much the same in a desert as in other areas. The lack of vegetation and permanent fixtures (forests, buildings) make it necessary to consider the construction of fortifications. Construction may be difficult because of sand inconsistencies, but sand, in combination with sandbags, will give additional protection from radiation exposure. Blowing winds and sand make widespread radiological survey patterns likely.

## JUNGLE EFFECTS ON CHEMICAL, BIOLOGICAL, RADIOLOGICAL, AND NUCLEAR HAZARDS

E-39. Tropical climates require the highest degree of individual discipline and conditioning to maintain effective CBRND readiness. Dominating climatic features of jungle areas are constant high temperatures, heavy rainfall, and very high humidity. There is usually little or no wind in a thick jungle, and the canopy blocks much of the sunlight from the ground. Commanders must expect and plan for a rapid decrease in unit efficiency and an increase in heat casualties. In addition, they must ensure that special precautions are taken to maintain unit CBRN defensive equipment in usable condition and avoid the rapid effects of mildew, dry rot, and rust that is inherent in jungle areas. The following paragraphs describe jungle effects on CBRN hazards:

- **Chemical.** Chemical agents used in jungle areas can cause extreme problems for friendly forces. Persistent agents delivered by artillery shells and aircraft bombs may penetrate the canopy before dissemination. These agents can remain effective on jungle floors for extremely long periods. High temperatures can increase vapor hazards from liquid agents. Nonpersistent agent vapors hang suspended in the air for extended periods because of low wind speeds. However, these wind speeds minimize downwind vapor hazards. Chemical agents employed in jungle areas make MOPP gear necessary for ground operations, and high temperatures and humidity combined with the heat-loading characteristics of MOPP gear degrade performance.
- **Biological.** Jungles provide excellent conditions for threat use of live biological agents. Warm temperatures, high humidity, and protection from sunlight increase the survivability of disease-causing microorganisms. Low wind speeds and jungle growth limit downwind hazards. Strict adherence to field sanitation procedures (especially vector and rodent control), the use of skin and clothing repellents, and the use of permethrin-treated bed nets are essential in jungles. These procedures will help control the naturally occurring diseases that abound. Personnel should don

masks and roll down sleeves to cover exposed skin and prevent possible contact with live biological agents.

- **Radiological and nuclear.** Dense vegetation has little influence on the initial effects of nuclear detonations, except that the heavy canopy provides some protection against thermal radiation. The blast wave creates extensive tree blowdown and missile effects. Some falling particles are retained by the jungle canopy, and reduced radiation hazards may result. However, subsequent rains will wash these particles to the ground. Particles will concentrate in water collection areas and produce radiation hot spots.

## MOUNTAIN EFFECTS ON CHEMICAL, BIOLOGICAL, RADIOLOGICAL, AND NUCLEAR HAZARDS

E-40. Mountainous areas require a high degree of CBRND preparedness. Rugged terrain limits the employment of large forces. Adjacent units may not be able to provide mutual support. Also, there may be reduced logistical support and difficulty in achieving rapid maneuver. In these circumstances, small U.S. units can impede, harass, or canalize numerically superior threat forces. The intention is to dissipate threat strength and compel threat forces to fight a decisive battle under unfavorable circumstances. Mountain warfare requires friendly units to be almost completely self-sufficient in CBRN protection. The following paragraphs describe mountain effects on CBRN hazards:

- **Chemical.** Aerial delivery is a likely means of chemical munitions employment in mountain warfare. Personnel should be constantly alert for aerial strikes, and they should take protective actions immediately. Defense against chemical attacks in mountains is similar to that in flat terrain; however, the compartmentalization and micrometeorological effects in mountainous terrain will affect the cloud's downwind travel. For example, the wind could be blowing in different directions in adjacent valleys. Consequently, a chemical strike in one valley may not affect units in an adjoining valley.
- **Biological.** Defense against biological agents does not differ in principle in mountains from that in flat terrain.
- **Radiological and nuclear.** Nuclear targeting is easier in mountainous areas than in flat terrain because there are fewer roads and trails and personnel must move at slower speeds. Preparing fighting positions and building other protective shelters are difficult in rocky or frozen ground. Improvised shelters built of snow, ice, or rocks may be the only possible protection. Because of rapidly changing wind patterns, radiological contamination deposits may be very erratic. Hot spots may occur far from the point of detonation, and low intensity areas may occur very near it. Limited mobility makes radiological surveys on the ground difficult, and the difficulty of maintaining a constant flight altitude makes air surveys highly inaccurate. Natural shelters (caves, ravines, cliffs) provide some protection from nuclear effects and radiological contamination. Clear mountain air extends the range of casualty-producing thermal effects. Added clothing required by cool mountain temperatures, however, reduces casualties from these effects. Units operating under nuclear-warfare conditions should also carefully select positions where they will not be hit or trapped by avalanches or rock/mud slides.

## URBAN-AREA EFFECTS ON CHEMICAL, BIOLOGICAL, RADIOLOGICAL, AND NUCLEAR HAZARDS

E-41. To plan CBRND, commanders must understand how urban terrain will affect their mission in a CBRN environment. For example, TIM density will likely increase in an urban area, the downwind transport of aerosols will be influenced by the unique micrometeorological considerations in urban terrain (increased thermal buildup, thermal islands), and there will be a larger number of noncombatants. The following paragraphs describe urban-area effects on CBRN hazards:

- **Chemical.** Urban structures can protect against spray attacks, but this exchange for overhead cover creates other problems. Generally, chemical agents tend to find and stay in low areas found in urban locations (basements, sewers, subway tunnels). Personnel should avoid these low areas. Once an attack occurs, the detection of chemical contamination becomes very important. Personnel must thoroughly check areas before attempting to occupy or traverse them.

Conversely, chemical-agent concentrations will generally decrease with an increase in structure height, and personnel on the higher stories of a tall building should experience lower agent concentrations.

- **Biological.** Buildings and other urban structures can provide some immediate protection from direct spray. However, the stable environment of these structures may increase the persistency of biological agents. Toxins are very effective in an urban environment, and personnel should take the same precautions prescribed for chemical agents. Pound for pound, biological agents are more toxic than chemical agents; and agent effects are especially magnified in an enclosed area. Covert operations are particularly well suited for urban terrain. Existing water and food supplies are prime targets. Personal hygiene becomes increasingly important. Urban terrain increases the potential for person-to-person transmission of contagious biological agents. Commanders must establish and consistently enforce sanitary and personal-hygiene measures, including immunizations. They must also ensure that personnel drink safe water and must never assume that hydrant water is safe.
- **Radiological and nuclear.** Without additional preparation, unreinforced buildings do not provide adequate shelter from a nuclear blast. If used correctly, ground floors and basements of steel or reinforced concrete offer excellent protection from most effects, except overpressure. Personnel should avoid windows due to possible injuries from flying debris and glass. Personnel also may receive severe burns through openings facing ground zero. Storm drains and subway tunnels are readily available in most urban areas. These provide better protection than ground level buildings. Personnel should not use structures of wood or other flammable materials because they could burst into flames. Buildings do provide a measure of protection against radiological contamination; and personnel may travel through buildings, sewers, and tunnels. However, they should consider the dangers of collapse in the event of a blast.

## LITTORAL EFFECTS ON CHEMICAL, BIOLOGICAL, RADIOLOGICAL, AND NUCLEAR HAZARDS

E-42. During operations at the sea-land interface, multiple considerations impact CBRND operations. For example, land and sea breezes occur almost daily in tropical and mid-latitude regions on the coasts of islands and continents. This occurs because the land cools and heats more rapidly than the adjacent water. Therefore, the commander must be concerned about potential offshore CBRN agent threats and hazards. The following paragraphs describe littoral environmental effects on CBRN hazards:

- **Chemical.** Blister agents (especially mustards) may cause casualty-producing effects if personnel encounter them in salt or fresh water. Generally, water will cause some blister agents to hydrolyze; however, the temperature and relative acidity or basal content of the water will affect the rate of hydrolysis. Further, littoral operations in tropical areas (high temperatures, high humidity) can also enhance the casualty-producing effects of chemical agents.
- **Biological.** During littoral operations, meteorological conditions can be especially favorable for the use of biological agents. The offshore line release of a biological agent can cover larger areas. Biological-agent surveillance assets monitor for the presence of biological agents in the littoral environment. Even if the littoral environment is in an extreme temperate (cold or hot) climatic zone, a biological-agent aerosol can cause casualty-producing effects.
- **Radiological and nuclear.** The blast effects from a nuclear detonation can cause significant damage to military operations ashore and afloat, and ships could be damaged by tidal surges in such an attack. Reflective surfaces (water) can also enhance weapon thermal effects. Residual contamination can contaminate and hinder critical logistics over-the-shore operations.



## Appendix F

# Automated Chemical, Biological, Radiological, and Nuclear Information Management Systems

This appendix identifies the programs of record and emerging capabilities managed by the JPM-IS under JPEO-CBD.

## INFORMATION MANAGEMENT SYSTEMS

F-1. A number of IM systems with core capabilities for integrated early warning, battlespace management, battlespace analysis, modeling and simulation, and medical surveillance are currently under development or have been fielded for testing by the JPEO-CBD/JPM-IS, including JWARN, JEM, and Joint Operational Effects Federation (JOEF).

### JOINT WARNING AND REPORTING SYSTEM

F-2. The JWARN primarily provides an integrated early warning capability, an IM system, and a capability to analyze the OE. It provides the capability to query and disseminate critical, time-sensitive CBRN defense information throughout the OE to enhance overall FP. There are five primary mission-essential functions performed by JWARN: SA, warning, reporting, hazard prediction; and “basic” battle management analysis. The JWARN implements these functionalities to provide an enhanced CBRN defense capability for the warfighter.

### JOINT EFFECTS MODEL

F-3. The JEM provides a single, DOD-approved methodology and model that provides common representation of CBRN hazard areas and effects resulting from CBRN weapons and TIM. Operationally, JEM supports operational and crisis action planning to mitigate the effects of WMD, to include weapons with CBRN payloads and accidental TIM releases.

F-4. Additionally, JEM assists DOD components and allied or coalition forces by providing CBRN and TIM hazard predictions and effects to the warfighter during and after an incident. Analytically, JEM assists DOD components and allied or coalition forces to train jointly develop doctrine and tactics; and assess warfighting, technology, materiel development proposals, and force structure.

F-5. The JEM is interoperable with selected command, control, communications, computers, and intelligence (C4I) systems. Software applications on those C4I systems (JWARN) use JEM to provide an enhanced prediction of hazard areas to provide detailed warning to U.S. forces within those areas. Operational effects systems on those C4I systems (JOEF) uses JEM to predict hazard areas. JEM may also be operated as a stand-alone application that is not interfaced or networked with a C4I system.

### JOINT OPERATIONAL EFFECTS FEDERATION

F-6. The JOEF provides automated decision support tools that enable the joint force commander to more effectively and efficiently assess risk and allocate scarce resources in preparation for and during operations involving CBRN and TIM hazards.

F-7. The JOEF supports the assessment of military operations with CBRN-related risk levels and the preparation for the employment of CBRN defenses and resources. It JOEF provides deliberate (long-term) planning and analytical products to support the commander’s evaluation of CBRN impacts and operational planning. As operations move into the crisis action phase, JOEF provides products allowing the commander to plan for likely CBRN and TIM hazards and then assess and respond to actual hazards and impacts on warfighting missions.

F-8. As an analytical tool, JOEF assists the commander in the warfighting-mission decision process and is employed at operational commands and in CBRN command centers for the assessment of operational risk levels and allocation of resource needs. These tools assist operations planners in assessing and mitigating CBRN and TIM hazard operational degradation and vulnerabilities. The tools incorporate the interrelated effects of mission requirements, CBRN hazards, logistical concerns, medical implications and support needs (casualty estimation, troop exposures, casualty care, treatment) and the deployment of CBRN defense resources. The use of JOEF as an analytical tool allows the commander to conduct a comprehensive visualization of the joint battlespace in the CBRN environment.

## **JOINT WARNING AND REPORTING NETWORK CONCEPT OF OPERATIONS**

F-9. The JWARN resides in C2 centers at the echelon levels defined by the Services. It transfers data from existing sensors and to and from future sensors; provide alerts for potential CBRN risks to commanders, units, and C2 systems; activate alarms for personnel at risk; and send warning (dewarning) reports to affected units throughout the OE. Service-specific CONOPS for JWARN are described below.

### **U.S. ARMY**

F-10. The JWARN is located in C2 centers at the appropriate echelon and employed by CBRN defense specialists and other designated personnel who are trained in the system. The capability is available at theater to platoon level echelons. The JWARN (mission application software only) interoperates with the C2 systems located on vehicles that carry sensors and may completely reside on these vehicles in future increments. It is located in areas where CBRND warning and reporting, analysis, and planning are required and where information is displayed on the COP. JWARN requires network or direct connectivity to receive timely detection information from deployed sensors and NBC reports from observers and CBRN reconnaissance assets.

F-11. The JWARN relies on network connectivity to disseminate CBRN hazard warning, reports, contamination overlays, and related products. JWARN software is capable of interoperating or residing on the Services' C2 systems of choice, which include the Maneuver Control System; Global Command and Control System—Army; and Force XXI Battle Command, Brigade and Below (FBCB2) (and future FBCB2 products) in vehicles, tactical operations center, and unit command posts. JWARN is able to use, publish, and subscribe service and, later, use the Defense Dissemination System for sending and receiving information and data. Subsequent increments require that these products be developed as Net-Centric Enterprise Services—compliant services that would be hosted on the Battle Command Common Services infrastructure in support of the USA technical vision for implementing the Battle Command Migration Plan to transition to Net-Centric Enterprise Services.

F-12. The JWARN is operated by personnel who are currently operating the host C2 system. At battalion and above, the software is operated by a CBRN officer.

### **U.S. MARINE CORPS**

F-13. The USMC employs JWARN mission application software only. USMC CBRN defense personnel assigned to CBRN centers and sections use the JWARN mission application software. The JWARN mission application software is used to provide the Marine air-ground task force (MAGTF) commanders with a comprehensive analysis and warning capability to access, assimilate, and disseminate CBRN and TIM information throughout the COP.

F-14. The JWARN mission application software provides the operational capability to employ CBRN warning technology, which collects, analyzes, identifies, locates, reports, and disseminates CBRN threats. It allows the operator to predict and track the actual movement of CBRN hazard areas within a multidimensional battlespace.

F-15. The JWARN mission application software may be used as a planning and training tool and is integrated into the Global Information Grid; Global Command and Control System—Joint, Joint Command and Control, Intelligence Operations System; and Intelligence Operations Workstation and interfaced via



Command and Control Personal Computer. MAGTF commanders can use this information operationally to take immediate actions necessary to protect personnel and equipment in the affected area, thus enabling decision superiority.

## **U.S. NAVY**

F-16. The USN intends to employ only the JWARN mission application software at present. The JWARN mission application software resides on USN C2I/command, control, communications, computers, intelligence, surveillance, and reconnaissance (C4ISR) systems throughout the fleet, expeditionary, and shore facilities as necessary. The JWARN is operable with the USN C2I/C4ISR systems, and be compatible with those systems with respect to databases, maps, and shipboard displays. After requisite training, the USN expects JWARN to be operated by Seamen in the operations specialist, intelligence specialist, and aerographer's mate ratings.

## **U.S. AIR FORCE**

F-17. For peacetime mission profile/deployment, JWARN is fielded to civil engineer readiness flights, engineer squadrons (RED HORSE), Silver Flag training sites, Civil Engineering Readiness Technical School, USAF School of Aerospace Medicine, civil engineering readiness positions not within a flight, and CBRN staff sections at combined air operations centers, numbered air forces, major commands, and Air Staff. JWARN is provided to units with UTCs that require a designed operational capability for deployment to medium- and high-threat areas. JWARN is employed in the readiness control center and/or the CBRN cell (primary, alternate, and tertiary) portion of the EOC at wing operational locations.

F-18. The JWARN is maintained in an operational status with networked sensors and C2 functions at high- and medium-threat installations when intelligence dictates a near-term or immediate CBRN threat. CONUS locations may use JWARN for the modeling and prediction of TIM hazards and to respond to the use of WMD. Configurations of JWARN integrates CBRN sensors and provide automated operation.

F-19. Readiness (Air Force specialty 3E9X1) and bioenvironmental (Air Force Specialty 4B0X1) technicians use JWARN to access and monitor the performance of CBRN sensors on the air base. Detection data transfers automatically or with human intervention from the actual sensors to C2 systems. Commanders use the analyzed data to make decisions for disseminating warnings down to the lowest level of the OE.

F-20. For wartime mission profile/employment, civil engineer readiness flights, RED HORSE squads, bioenvironmental flights, and CBRN staff sections at combined air operations centers, numbered Air Forces, major commands, and headquarters, is responsible for operational employment, analysis, and update of CBRN hazard information. Upon the escalation of CBRN activities, operators run the JWARN software within the CBRN cell to analyze, plot, and report CBRN attack information up, down, and laterally along the military command structure. Operators also use JWARN products to support briefings to commanders covering CBRN warfare hazards within the immediate AOR and, to some extent, the theater. Contamination persistency or intensity plots provide commanders with a definitive picture to match written guidance contained in the current version of ATP-45.

F-21. Each USAF installation that is subject to deployment to a high or medium CBRN threat area establishes/maintains a deployable UTC. The following deployable UTCs: 4F9DA, 4F9DB, 4F9E9, 4F9R2, 4F9R5, and FFGL7 is provided to the JWARN software (current version) and to sufficient interfaces required to support the networking of detection sensor systems contained on the UTC. When employed at a fixed site with a high/medium threat, in-place and deployable assets is merged to create one CBRN detection grid network.

## **JOINT EFFECTS MODEL CONCEPT OF OPERATIONS**

F-22. Operational units collect and report CBRN information to a CBRN cell. Through CBRN warning systems (JWARN), the CBRN cell collects and correlates this information. The JEM is used automatically or manually to calculate the transport and dispersion. For example, the plumes of CBRN events, taking into account the terrain and weather information collected from appropriate agencies. The plumes of CBRN

events are formatted and processed by the warning system and broadcast to operational units' COPs to provide a standardized picture of the effects of the CBRN event throughout the battlespace. When a network is unavailable, JEM may also be operated as a stand-alone application that is not interfaced or networked with a C4I system. Service-specific CONOPS for JEM are described in the following paragraphs.

## U.S. ARMY

F-23. The JEM is used by CBRN officers (74A) and CBRN NCOs (74D) of the chemical staff sections at the battalion, brigade, division, corps, and echelons above corps levels, and Special Forces chemical reconnaissance detachments. Brigade, division, and corps levels also have a stand-alone version of JEM that is used by CBRN staff planners. The JEM operates within USA Service organizations on computer systems operating within local area networks and wide area networks, including Non-Secure Internet Protocol Router Network (NIPRNET) and Secret Internet Protocol Router Network (SIPRNET) systems. The JEM is operationally imbedded within the Global Command and Control System (GCCS), joint tactical COP workstation hosted on a Command and Control Personal Computer Air and Missile Defense Planning and Control System, Medium Extended Air Defense System, or Terminal High-Altitude Area Defense Systems and follow-on air defense artillery theater missile defense systems, unified combatant commands, and air defense artillery.

## U.S. MARINE CORPS

F-24. The JEM, along with other battle management systems, provide commanders with information on possible CBRN hazards throughout their AO.

F-25. The primary purpose of JEM is to provide the MAGTF commander with an operational tool whose outputs can be used to support planning and assessment decisions to mitigate the effects of WMD, to include CBRN and TIM agents. JEM assists the MAGTF commander to train jointly; develop doctrine and tactics; and assess warfighting, technology, materiel development proposals, and force structure. A commander uses CBRN incident information from JEM to assist in deciding what actions are necessary to protect personnel and equipment from the potential damaging effects of CBRN and TIM hazards. It is also used to conduct planning and training by providing the MAGTF commander with a tool that is capable of modeling CBRN and TIM threats within an AO.

F-26. The JEM is integrated with JWARN and, communicate via standard USMC communications systems to the appropriate command chemical, biological, radiological, and nuclear control center (CBRNCC). The JEM is also used by USMC operating forces as a predictive model that provides a higher level of fidelity of actual ground contamination and can be used to simulate urban releases of military significant agents and accidental TIM releases.

F-27. The JEM is resident on USMC C4I systems loaded with JWARN at the major subordinate command (MSC) level and above. It operates with the current version of Command and Control Personal Computer and be capable of functioning with USMC GCCS applications. JEM is resident on the intelligence operations workstations and operate with the Intelligence Operations Server.

## U.S. NAVY

F-28. The JEM is used at each step of the dynamic planning and execution cycle. Based on the commander's intent and guidance, the current and future planning staff would use JEM in the assessment and development of CBRN effects on current and future plans. In addition, the intelligence staff would use JEM for CBRN effects analysis. The future operations and strike planning staffs would use JEM to update the current plans according to the optimized individual and collective CBRN effects on the current plans and target strike packages. Once operational plans are executed, the current operations staff would use JEM to assess the effects of enemy CBRN attacks and to access CBRN battle damage. The commander would select and execute an optimized alternative COA plan to successfully accomplish the mission. The CBRN effects lessons learned would be used in the next planning cycle.

F-29. For consequence and strike planning, JEM uses intelligence and operational SA data to prepare consequence analysis dispersion forecasts, according to theater guidance before the mission, for operational planning purposes. After the mission is completed, JEM incorporates battlefield intelligence data to prepare consequence plume forecast products for follow-on operations.

F-30. At sea, JEM supports the JTF, deployed forces (carrier strike groups, and expeditionary strike groups, and independent units where shipboard detectors and data are networked across the theater of operations and data integration and analysis is conducted at a higher level C2 center). In ports where there is no local military CBRN command, ships coordinate with local civil disaster preparedness organizations and notify the established military chain of command for CBRN events. Unit C2 personnel receive JEM plume dispersion products via Global Command and Control System–Maritime, according to theater and Naval component commander guidance to assess probable CBRN effect vulnerabilities.

F-31. For CONUS shore installations, initial JEM plume dispersion forecasts are produced by the Navy Atlantic Mission Essential Meteorological and Oceanographic Center, Norfolk (Naval Meteorology Oceanography Center) until the Defense Threat Reduction Agency (DTRA) assumes responsibility as head of the CBRN cell. The Naval Meteorology Oceanography Center or DTRA forwards plume products according to respective Department of Homeland Security/JTF-Civil Support agreements for distribution by U.S. Northern Command. JEM data requirement reports and plume products for outside the continental United States (OCONUS) is prepared and distributed according to established theater and Naval component guidance.

F-32. During tactical or mobile situations, unit C2 personnel receive JEM application data via Global Command and Control–Maritime to assess probable CBRN effect vulnerabilities to better position the unit for CBRN contamination avoidance and deploy sensors and assets against a probable CBRN attack threat axis.

## **U.S. AIR FORCE**

F-33. The JEM, used in conjunction with JWARN, provides commanders and warfighters with integrated near-real-time early warning capability. It is a DOD-accredited hazard prediction model and supports consequence and COA analysis for a CBRN event. The JEM supports multiple deployment strategies and is capable of functioning as a stand-alone, networked, or web-based application. It is integrated and fully interoperable with JWARN and also provides a capability to transmit vital CBRN information to the theater COP.

## **JOINT OPERATIONAL EFFECTS FEDERATION CONCEPT OF OPERATIONS**

F-34. The JOEF supports tactical mission environment users in deliberate and, to a lesser degree, crisis action planning by calculating resources needed, recommending COAs, and providing deliverables (checklists, impact and risk assessments). It supports these users in their near-real-time crisis planning during and after a CBRN event by supplying consequence tools and services. JOEF decision support tools complement the decision support tools provided by the JWARN at the tactical level of warfare in current operations and during consequence phases.

F-35. The JOEF is developed in three increments:

- **Increment 1.** APODs/fighter bases, SPODs, and medical and mobile forces; auto TTP and COE; deliberate planning (operational and strategic); and crisis planning (operational).
- **Increment 2.** Military consequence, deliberate and crisis action planning (operational), common operating environment, and uncommon operating environment.
- **Increment 3.** Civilian consequence (nonnetworked).

## **DEPARTMENT OF DEFENSE GLOBAL EMERGING INFECTIONS SURVEILLANCE AND RESPONSE SYSTEM**

F-36. The DOD Global Emerging Infections Surveillance and Response System is designed to strengthen the prevention of, surveillance of, and response to infectious diseases that—

- Are a threat to military personnel and families.
- Reduce medical readiness.
- Present a risk to U.S. national security.

F-37. The DOD Global Emerging Infections Surveillance and Response System—

- Increases DOD emphasis on the prevention of infectious diseases.
- Strengthens and coordinates DOD surveillance and response efforts.
- Creates a centralized coordination and communication hub to help organize DOD resources.
- Links DOD with U.S. and international efforts.

F-38. The DOD Global Emerging Infections and Surveillance Response System carries out the following functions:

- Conducts active global surveillance for infectious diseases that might affect military personnel and their dependents.
- Carries out preventive programs to reduce or eliminate the risk of infectious diseases.
- Trains DOD health and non-DOD personnel (at their expense) in DOD laboratories and other DOD facilities and programs.
- Develops, in conjunction with other health programs, a robust core of preventive health/medicine (including epidemiology) expertise.
- Educates DOD personnel on the risk of infectious diseases and the actions which can help reduce the risk.
- Sustains and strengthens DOD detection and diagnostic capability, especially in CONUS and OCONUS laboratories operated by DOD.
- Sustains and strengthens DOD response systems for addressing threats to military personnel and their dependents.
- Links the DOD response system with the overall U.S. and international system for addressing infectious disease threats worldwide, in partnership with U.S. and non-U.S. public and private sector agencies.

## **THEATER MEDICAL INFORMATION PROGRAM**

F-39. The Theater Medical Information Program is a multi-Service system used by the USA, USMC, USN, and USAF. It provides information to deployed medical forces to support medical functional areas, including C2, medical logistics, blood management, patient regulation and evacuation, health threat/intelligence, health care delivery, manpower and training, and medical capabilities assessment and sustainment analysis.

F-40. The Theater Medical Information Program provides a global capability which links information databases and integration centers that are accessible to the warfighter anywhere, anytime, and in any mission. The program links information from echelons of medical care in support of time-sensitive decisions that are critical to the success of theater operations. This information is made available to theater commanders through integration with the GCCS, Global Combat Support System, and Global Military Health System. The Theater Medical Information Program supports—

- The integration of medical capabilities under a joint CONOPS to assist the medical commander/theater surgeon and to support the delivery of seamless combat medical care.
- Field medical operations and decisionmaking concerning theater medical capability by providing integrated health decision support systems to ensure readiness for mission execution.
- Echelons of care through an aggregation of medical data and situation reports that serves the theater of operations and sustaining base medical missions in CONUS.

## **BATTLEFIELD MEDICAL INFORMATION SYSTEMS TELEMEDICINE–JOINT**

F-41. The battlefield Medical Information Systems Telemedicine–Joint provides medics with enhanced data collection on the battlefield by improving data accuracy, reducing paperwork, supporting the collection of more complete information, eliminating redundant data entry, allowing faster adaptation to changing conditions, and providing access to previously unavailable information. This application allows the combat medic to record patient encounters to mission requirements and transfer patient records to higher echelons.

## **ARMED FORCES HEALTH LONGITUDINAL TECHNOLOGY APPLICATION–THEATER**

F-42. The Armed Forces Health Longitudinal Technology Application–Theater is a component of Theater Medical Information Program. Armed Forces Health Longitudinal Technology Application–Theater is a tri-Service (USA, USN, and USAF) medical management automated information system that is used in medical treatment facilities worldwide, and it provides anytime and anywhere delivery of patient records to the point of care. The Armed Forces Health Longitudinal Technology Application–Theater, along with the Theater Medical Information Program, makes true clinical surveillance and decision support possible.

## **MEDICAL, ENVIRONMENTAL, DISEASE, INTELLIGENCE, AND COUNTERMEASURES**

F-43. Medical, Environmental, Disease, Intelligence, and Countermeasures is a government, off-the-shelf application. It is an automated medical reference tool that is designed to provide information on worldwide disease and environmental health risks.

## **MEDICAL COMMUNICATIONS FOR COMBAT CASUALTY CARE**

F-44. The Marine aircraft wing integrates, fields, and supports a medical IM system for U.S. tactical medical forces, enabling a comprehensive, lifelong electronic medical record for Service members and enhancing medical SA for operational commanders.

## **GLOBAL EXPEDITIONARY MEDICAL SYSTEM**

F-45. Global Expeditionary Medical System is an integrated biohazard surveillance and detection system that keeps a global watch over our forces. It incorporates an electronic medical record as a basis for real-time data analysis and serves as the foundation of a USAF integrated surveillance and medical IM network. Through the Global Expeditionary Medical System, data collection, assessment, and trend analysis are automatically performed at the operational, tactical, and strategic levels—at units, bases, and U.S.-based centers of excellence. Individual, specific analysis provide quick patient diagnosis and treatment. With ongoing site and regional data review, population-specific analysis identifies disease trends to provide an early warning of outbreaks or biological attacks. The Global Expeditionary Medical System contains four modules.

## **PATIENT ENCOUNTER MODULE**

F-46. The patient encounter module collects and creates the electronic medical record. It can synchronize with a handheld computer platform to enhance mobility and agile documentation of patient care. The patient encounter module maps symptom complexes and diagnostic information for the deployed-population database to epidemiological tracking and analysis software in a Global Expeditionary Medical System unit, and it prints reports (patient encounters for the permanent record, disease and injury data). The Global Expeditionary Medical System does not require a dedicated server, and each laptop module has stand-alone capability and can support multiple handheld platforms.



## **THEATER EPIDEMIOLOGICAL MODULE**

F-47. The theater epidemiological module takes the data collected by the other modules and provides powerful, easy-to-use analysis tools to enable the users to make fact-based decisions regarding FP, medical conditions or events, occupational and environmental exposure, environmental impact, and disease management. Primarily designed as a management tool for the prevention and aerospace medicine team and the JTF surgeon, the theater epidemiological module offers the automated surveillance and reporting of deployed force health and readiness. The theater epidemiological module is also web-enabled for IM capability in stability and civil support operations. It converts patient encounter data entered from the Global Expeditionary Medical System Patient Encounter Module into a graphic display and analysis of the patient data. Geographic AORs are mapped to show separate points of care, and then user-defined surveillance queries are automatically run on medical data from each location in the database. The first indication of a biological warfare release may come from the expert analysis of clinical medical data for military and civilian populations with symptoms that indicate exposure to a biological warfare agent.

## **THEATER OCCUPATIONAL MODULE**

F-48. The theater occupational module documents industrial and environmental exposures. It is a far-forward extension of the USAF Command Core System functionality. The Theater Occupational Module is able to record, track, and monitor occupational and environmental concerns in the expeditionary setting. Working in concert with the patient Encounter Module and the Theater epidemiological module, industrial health and environmental issues may be linked to individual patients or analyzed for work group, location, and theater events and trends.

## **PUBLIC HEALTH DEPLOYED MODULE**

F-49. The public health deployment module documents preventive medicine-related information and exposures. It can be expanded to work from a handheld unit for most evaluations. Information is aggregated at progressively higher levels, allowing for accurate theater assessment, epidemiological monitoring, and decisionmaking. The public health deployment module is an intuitive data-linked tool for public health personnel and/or independent duty medical technicians to record preventive medicine assessments. It is applicable to—

- Food inspections.
- Operational rations.
- Food facility inspections.
- Public facility inspections.
- Medical entomology.
- Communicable diseases.

## **ELECTRONIC SURVEILLANCE SYSTEM FOR THE EARLY NOTIFICATION OF COMMUNITY-BASED EPIDEMICS**

F-50. The purpose of the Electronic Surveillance System for the Early Notification of Community-Based Epidemics is to provide early warning of abnormal health conditions that may be the result of bioterrorism or disease outbreak. In addition, it is a valuable medical SA tool for epidemiologists and health officials who continually monitor the health of their communities. It receives a variety of health indicator data (doctor visit information, emergency room primary complaints, sales of over-the-counter drugs, school absenteeism). The system integrates clinical and nonclinical human behavior indicators as a means of identifying the abnormality as close to the time of symptoms onset as possible.

## Appendix G

# Preparation Activities

The basic element for maintaining adequate preparedness is a clear understanding of the CBRN threat, hazards, and operational requirements, CONUS and OCONUS. To support operational requirements, commanders' preparation activities must identify specific mission-essential CBRN tasks that facilitate operations in CBRN environments. During preparation activities, the emphasis is on evaluating operation progress, identifying variances, and determining the significance of those variances. Preparation allows friendly forces to improve their chances of success.

## CONSIDERATIONS

G-1. Commanders of forces and facilities must assess vulnerabilities that may compromise peacetime preparedness. The actions that commanders take to reduce vulnerabilities depend on their assigned missions and supporting plans. During preparation, commanders use the understand-visualize-describe-direct methodology to exercise C2. Commanders update and validate their visualization as relevant information and assessments based on the running estimates received. Commanders' SA changes as they receive new information—assumptions may prove true or false, intelligence may confirm or deny enemy actions and conditions in their OE, or the status of friendly forces may change. As their SA changes, commanders apply judgment to determine the significance of the changes and their possible effects on the operation. Significant new information produces a new situational understanding and requires commanders to make one of the following assessments with respect to the order:

- New information validates the order with no further changes.
- New information requires adjusting the order.
- New information invalidates the order.

G-2. The preparation for operations in CBRN environments includes the measures taken by commanders, with appropriate emphasis on—

- Conducting CBRN threat assessment.
- Evaluating force and unit status.
- Assessing training readiness.
- Ensuring coordinated planning.
- Conducting training.
- Taking medical protective measures.
- Verifying and exercising warning and reporting information networks.
- Preparing CBRND units, equipment, and supplies.
- Coordinating for HN support, as required.
- Verifying responsibility for coordinating CBRN defensive activities within an AO (determining which unit provides the base cluster commander and who is responsible for terrain management).
- Revising and refining the order or plan.
- Conducting rehearsals.
- Task-organizing.
- Conducting troop movements.
- Conducting preoperation checks and inspections.
- Conducting logistics preparations (during execution, this includes recovery and rearming).



- Integrating new warfighters and units.
- Providing subordinate confirmation briefs and backbriefs.

### RECONNAISSANCE AND SURVEILLANCE OPERATIONS

G-3. Reconnaissance and surveillance operations often begin during planning to fill information gaps that are identified during mission analysis and support the integrating processes. Such operations are evaluated against operation security considerations so that friendly operations are not compromised. CBRN units prepare by providing reconnaissance for their specific mission areas. Timely reporting allows the CBRNC to assess the total status of mission resources and assign recovery forces where they are most effective. Unit CBRN reconnaissance teams and individuals generally do not begin operations until directed to do so by the CBRNC.

### ORDER OR PLAN REVISION OR REFINEMENT

G-4. Plan refinement consists primarily of revising the plan based on changes in the situation and command and staff visits to subordinate elements.

### COORDINATION AND LIAISON

G-5. Battle rhythm is a control measure and integrative process that assists with synchronizing the continuing activities and integrating processes during preparation. It establishes a schedule for commanders and staffs that synchronize routine meetings, working groups, and reports. Mission coordination must be thorough and detailed since CBRN reconnaissance assets act semi-independently, temporarily move beyond direct-fire support of the supported unit, and occasionally operate forward of friendly units.

G-6. Close coordination with the supported unit is also necessary during defensive operations. This will reduce the possibility of fratricide. Items to coordinate with the supported unit include—

- Changes and updates in the enemy and friendly situations.
- The best use of terrain for CBRN operations.
- Light and weather data.
- Rehearsal areas and times.
- Special equipment requirements.
- HSS, including medical evacuation.
- Logistics support.
- Signal plan call signs, frequencies, code words, pyrotechnics, challenges, and passwords.
- Identification tools to reduce the incidence of fratricide.

G-7. Operations may require the application of specialized CBRN assets which have detection capabilities that exceed those found in most military units (lower detection thresholds). These activities may require intensive coordination and cooperation with multinational forces, HN civil authorities, and other U.S. government agencies that offer specialized capabilities and skills.

### REHEARSALS

G-8. Rehearsals are the commander's tool for ensuring that staffs and subordinates understand the commander's intent and CONOPS. Rehearsals allow subordinate units and leaders to analyze the tactical plan to confirm its feasibility, and practicality and the adequacy of its C2 measures. For CBRN units and staff to be effectively and efficiently employed in combat, rehearsals need to become habitual in training. Units at every level should routinely train and practice a variety of rehearsal types and techniques. Local SOPs should identify appropriate rehearsal types, techniques, and standards for their execution.

G-9. Time is the key to conducting rehearsals, and time is probably the most precious resource available to commanders and units. When time is at a premium, the CBRN battle staff conducts reduced rehearsals, focusing only on critical events, using the backward planning cycle.

G-10. Key support factors need to be part of the rehearsal, including plans for casualty evacuation, routes, ambulance exchange point locations, refuel on the move, Class IV and Class V resupply points, and logistics release points. These items should be injected into the rehearsal at the appropriate times by the coordinating CBRN staff officer. Summarizing these actions at the end of the rehearsal weakens the value of the rehearsal as a coordination tool.

## PRECOMBAT CHECKS/INSPECTIONS

G-11. At the tactical level, precombat checks and inspections provide a start point for readiness. Unit SOPs and equipment operations and maintenance manuals should be used as a basis for conducting precombat checks/inspections.

G-12. These procedures can be conducted in three different fashions: by the team leader, by the unit leader, and by a CBRN SME. When the team leader conducts precombat checks/inspections, it reinforces the warfighters' trust in their team leader and ensures that the warfighters report ready to execute the mission when they report for duty. When the unit leader executes precombat checks/precombat inspections, it ensures that the leadership is comfortable that the warfighters and their equipment are ready to execute the mission. Finally, when a subject matter expert conducts the precombat checks/inspections (mechanics performing preventive-maintenance checks and services, medics inspecting the combat lifesaver bags for readiness), it enhances the chance of a successful mission.

G-13. The following are some of the tasks that should be considered when conducting precombat checks/inspections:

- **Vehicles.** Each vehicle must be inspected for serviceability. At a minimum, a complete preventive-maintenance checks and services inspection should be conducted before mission execution. Check fluid levels, personnel equipment storage, and load plans.
- **Weapons.** Weapons must be inspected for cleanliness and serviceability. Ensure that Service members can perform proper maintenance and function checks on their assigned weapons. Check each Service member's qualification record to ensure that the Service member is qualified on the weapon. Finally, check the ammunition and magazines to ensure cleanliness and serviceability.
- **Individual.** Leaders must ensure that their team's personal equipment is serviceable, including uniforms, personal-hygiene items, food, and water.
- **Communications.** Communications equipment must be serviceable. Ensure that each radio has the proper frequencies programmed, to include team, company, battalion, and supported unit command. Ensure spare hand microphones, batteries, and cables are available.
- **CBRN.** Check the serviceability of identification and detection equipment, and ensure that it is positioned so that the crew can easily use it. Ensure sufficient spare batteries are present.
- **SA.** Team members need to maintain SA of the operations being conducted. This includes understanding applicable orders, call signs and frequencies, challenges and passwords, and support element operations.

G-14. Unit or team level precombat checks/inspections checklists are useful to ensure that areas of concern are addressed during the preparation phase of an operation. Such checklists provide members of the unit with a standardized format to assist leaders in preparing their teams for operations.

## EXERCISE CONSIDERATIONS

G-15. The exercise experience is a dynamic and interactive way to learn the intricate parts of warfighter procedures and skills. CBRN principles, decision support tools, and TTP must be integrated into significant exercises and war games to offer additional opportunities to develop and evaluate individual and unit CBRN competencies. Commanders should continually assess the impact of training, exercises, and war games on their units' abilities to conduct wartime missions.

G-16. To ensure effectiveness, CBRN education and training must be validated through exercises and war games, using time-tested principles and experience. Providing an exercise environment for warfighters to hone CBRN knowledge and skills is critical. Exercises and war games serve as effective methods of

developing individual experience and organizational capabilities under controlled conditions. In addition to providing instruction, they may also aid in evaluating performance and the effectiveness of training and education programs.

G-17. Exercises and war games should include a realistic CBRN element, emphasize critical thinking, and require participants to demonstrate their skills in personal protection, performing wartime functions and working together as an integrated unit in a simulated CBRN-contaminated area. CBRN exercises and war games should emphasize the aspects of operations in a CBRN environment, to include C2, emergency management, postattack ISR, planning, logistics, medical response, FP, and individual and collective protection. When possible, units should also conduct joint, allied, and coalition CBRN exercises to develop and improve interoperability.

## TRANSITION TO EXECUTION

G-18. There are multiple preparatory considerations that support the actions involved in the transition to sustained operations. CBRN preparatory considerations can include the following:

- **Intelligence.** Commanders and CBRN staffs use IPOE/IPB to direct CBRN operations. They gain information that is critical to making decisions in defined areas and specific locations (assigning CBRN reconnaissance elements to cover specific NAIs).
- **Force organization and training.** Units train and exercise CBRN detection and identification capabilities as part of their integrated CBRN warning and reporting network. Leaders understand CBRN detection capabilities, and staffs prepare effective employment plans that maximize the probability of detection. Unit leaders assess team and overall unit performance and ensure that CBRN-related factors (environmental impact on detections) are understood.
- **Theater access maintenance.** Contingency planning ensures that required CBRN assets are included on the time-phased force and deployment list. The list is also evaluated to ensure inclusion of technical escort, medical laboratory, and CBRN unit resources (C2 elements, C2 control centers) as appropriate.
- **Logistics support and sustainment.** Commander and staff planning sustains CBRN capabilities, ranging from designating decontamination points for CBRN decontamination assets to ensuring system level contracted logistics support.
- **Physical environment.** Seasonal effects on terrain, weather, and sea conditions are carefully assessed before and during operations to determine the potential impact on CBRN capabilities.

## Appendix H

# Technical Reachback and Other Capabilities

Technical reachback is the ability to contact a technical SME when an issue exceeds the on-scene SME's capability. Reachback should be conducted by using established unit protocols. Many of the listed reachback resources included in this appendix have other primary missions and are not specifically resourced for reachback functions.

### ISSUES

H-1. Issues appropriate for technical reachback may include the following:

- **Identification of nonstandard CBRN warfare agents.** Military responders are trained to detect and identify certain military warfare agents. If a TIM is used or suspected, military personnel must obtain nonstandard technical information. This information could include persistency, medical effects, and decontamination or protection requirements.
- **Modeling.** Technical reachback should provide the ability for detailed analysis of the area to assist in determining downwind hazard areas and locating staging areas, operations centers, and decontamination sites.
- **CBRN agent sample evacuation.** Technical evaluation of evacuated samples can provide critical information for patient treatment and/or be used as evidence for prosecution.
- **Hazard prediction.** Technical experts can use modeling to provide a better indication of where vapor, liquid, or aerosolized hazards may occur.

H-2. Reachback can be accomplished through various means, from the telephone to broadband satellites; however, IM protocols and the chain of command must be followed before using a hotline number. (See table H-1 for some common technical reachback numbers.)

**Table H-1. Technical reachback contact information**

<i>Agencies</i>	<i>Contact Information</i>	<i>Capability</i>			
		<i>C</i>	<i>B</i>	<i>R</i>	<i>N</i>
<i>DOD</i>					
AFRRI	(301) 295-0316/0530	X		X	X
DTRA	Toll-free: (877) 240-1187 DSN: 427-2003 COMM: (703) 767-2003 Secure: (703) 767-2115 ISD: 80 4277819 NIPRNET: opscntr1@dtra.mil SIPRNET: opscntr1@dtra.smil.mil	X	X	X	X
ECBC	(800) 831-4408	X	X		
USAMRIID	(888) 872-7443 < <a href="http://www.usamriid.army.mil/">http://www.usamriid.army.mil/</a> >		X		
USAMRICD	(410) 436-3277 < <a href="http://chemdef.apgea.army.mil/">http://chemdef.apgea.army.mil/</a> >	X			

Table H-1. Technical reachback contact information (continued)

<i>U.S. Army CBRN Capabilities</i>					
USACBRNS	< <a href="https://www.us.army.mil/suite/page/409522">https://www.us.army.mil/suite/page/409522</a> >	X	X	X	X
USACHPPM	(800) 222-9698 < <a href="http://chppm-www.apgea.army.mil">http://chppm-www.apgea.army.mil</a> >	X	X	X	X
<i>U.S. Navy CBR Capabilities</i>					
NMRC	< <a href="http://www.nmrc.navy.mil">http://www.nmrc.navy.mil</a> > <bdrd1@nmrc.navy.mil> <bdrd2@nmrc.navy.mil>		X		
NEHC	<plansops@nehc.navy.smil.mil> < <a href="http://www.nehc.med.navy.mil">http://www.nehc.med.navy.mil</a> >	X	X	X	
NEPMU 2, Norfolk, VA	DSN: 564-7671 COMM: (757) 444-7671 <nepmu2@nepmu2.med.navy.mil>	X	X	X	
NEPMU5, San Diego, CA	DSN: 526-7070 COMM: (619) 556-7070 <nepmu5@nepmu5.med.navy.mil>	X	X	X	
NEPMU 6, Pearl Harbor, HI	(DSN) 473-0555 (COMM) (808) 473-0555 <nepmu6@nepmu6.med.navy.mil>	X	X	X	
FDPMU	< <a href="http://www-nmcphc.med.navy.mil/EPM/Index.htm">http://www-nmcphc.med.navy.mil/EPM/Index.htm</a> > NIPRNET: <EPM@nehc.mar.med.navy.mil> SIPRNET: <plansops@nehc.navy.smil.mil>	X	X	X	X
<i>DHS Agencies</i>					
NRC CB Hotline	(800) 424-8808 or (202) 267-2675 < <a href="http://www.nrc.uscg.mil/nrchp.html">http://www.nrc.uscg.mil/nrchp.html</a> >	X	X		
FEMA	(800) 621-FEMA (3362)	X	X	X	X
<i>Other Federal Agencies</i>					
CDC	(800) CDC-INFO (232-4636)	X	X		
Department of Energy, Radiation Emergency Assistance Center	(865)-576-3131			X	X
EPA Environmental Response Team	(732) 321-6743	X	X	X	X
NIOSH	(800) 35-NIOSH (356-4674)	X			
National Atmospheric Release Advisory Center	(202) 586-8100	X	X	X	X
<i>State Agencies</i>					
State Emergency Management Agencies	< <a href="http://www.fema.gov/about/contact/statedr.shtm">http://www.fema.gov/about/contact/statedr.shtm</a> >	X	X	X	X

**Table H-1. Technical reachback contact information (continued)**

<b>Legend:</b>	
AFRRI	Armed Forces Radiobiology Research Institute
B	biological
C	chemical
CA	California
CB	chemical-biological
CBR	chemical, biological, and radiological
CDC	Centers for Disease Control and Prevention
COMM	commercial
DHS	Department of Homeland Security
DOD	Department of Defense
DSN	Defense Switched Network
DTRA	Defense Threat Reduction Agency
ECBC	Englewood Chemical and Biological Center
EPA	Environmental Protection Agency
FDPMU	Forward-Deployable Medicine Unit
FEMA	Federal Emergency Management Agency
HI	Hawaii
ISD	Information System Directorate
N	nuclear
NEHC	Navy Environmental Health Center
NEPMU	Navy Environmental and Preventive Medicine Unit
NIOSH	National Institute for Occupational Safety and Health
NIPRNET	Nonsecure Internet Protocol Router Network
NMRC	Navy Medical Research Center
NRC	National Response Center
R	radiological
SIPRNET	Secure Internet Protocol Router Network
USACBRNS	U.S. Army Chemical, Biological, Radiological, and Nuclear School
USACHPPM	U.S. Army Center for Health Promotion and Preventive Medicine
USAMRICD	U.S. Army Medical Research Institute for Chemical Defense
USAMRIID	U.S. Army Medical Research Institute for Infectious Disease
VA	Virginia

## NATIONAL RESPONSE CENTER CHEMICAL AND BIOLOGICAL HOTLINE

H-3. The CB hot line is a joint effort of the U.S. Coast Guard (USCG), Federal Bureau of Investigation, Federal Emergency Management Agency, Environmental Protection Agency (EPA), Department of Health and Human Services, and DOD. The National Response Center is the entry point for the CB hot line.

H-4. The intended users of the hot line include trained emergency personnel (emergency operators, first responders [firefighters, police, emergency medical technicians]) who arrive at the scene of a CB terrorist incident. Other potential users may include state EOCs and hospitals that may treat victims of agent exposure.

H-5. The USCG staffs the hot line 7 days a week, 24 hours a day. Trained operators use extensive databases and reference material in addition to having immediate access to the nation's top SMEs in the CB agent field. National Response Center duty officers take reports of actual or potential domestic terrorism and link emergency calls with applicable DOD SMEs for technical assistance and with the Federal Bureau of Investigation to initiate the federal response actions. The National Response Center also provides reports and notifications to other federal agencies as necessary. Specialty areas include the following:

- Detection equipment.
- Personal protective equipment.
- Decontamination systems and methods.
- Physical properties of CB agents.
- Toxicology information.

- Medical symptoms from exposure to CB agents.
- Treatment of exposure to CB agents.
- Hazard prediction models.
- Federal response assets.
- Applicable laws and regulations.

H-6. Use the local established policies and procedures for requesting federal assistance before contacting the CB hotline. State and local officials can access the hot line in emergency circumstances by calling (800) 424-8802.

## DEFENSE THREAT REDUCTION AGENCY

H-7. Established in 1998, the DTRA safeguards America and its allies from WMD (chemical, biological, radiological, nuclear, and high-yield explosives [CBRNE]) by providing capabilities to reduce, eliminate, and counter the threat and mitigate its effects.

H-8. The DTRA shapes the international environment to prevent the spread of WMD, responds to military requirements to ensure CCDRs have the offensive and defensive tools they need, including an effective nuclear deterrent, and prepares for an uncertain future shadowed by the threat of terrorist attack.

H-9. The DTRA provides technical WMD reachback information and services for on-scene personnel. The focal/coordination point for support is through the DTRA EOC, (877) 240-1187. The technical reachback element plays a key role in integrating and synchronizing DTRA efforts in combating WMD.

H-10. The DTRA Technical Reachback Center is comprised of military and civilian scientists, engineers, researchers, tactical operators, and WMD SMEs. The center provides a portal to the agency, allowing immediate access to the entire DTRA technical expert base that is available 24 hours a day, 7 days a week.

H-11. Three mission support enterprises carry out the DTRA critical national security mission:

- The Research and Development Enterprise identifies, conducts, and delivers innovative science and technology to combat WMD. Programs are managed by the CB Technologies, Nuclear Technologies, Counter WMD Technologies, and Basic and Applied Sciences Directorates.
- The Operations Enterprise directly supports the three pillars of the *National Military Strategy to Combat Weapons of Mass Destruction*. Programs are managed by the combat support element, on-site inspection, and cooperative threat reduction directorates.
- The Combating WMD Enterprise maintains SA of worldwide and related WMD activities and advocates for future capabilities. The Combating WMD Enterprise was created to directly support the U.S. Strategic Command Center for Combating WMD.

H-12. Other examples of DTRA reachback capabilities for CCDRs include the following:

- **DTRA reachback modeling and support capabilities.** DTRA has produced and uses an extensive array of modeling and simulation software for providing decision support analysis to CCDRs and staffs.
- **DTRA CBRNE decision support weather capabilities.** Weather capabilities provide tailored meteorological products and support to DTRA customers for transport and dispersion analysis and predictions. DTRA receives historical, current, and future forecast meteorological datasets from military and civilian operational data production centers.
- **DTRA reachback software modeling technical support.** DTRA reachback provides a 24/7 software technical assistance for most DTRA modeling and simulation tools.
- **FP/defense critical infrastructure protection.** DTRA provides reachback analysis to support CCDRs who are conducting FP planning.
- **DTRA reachback targeting support capabilities.** Reachback maintains planning databases that are comprised of targets related to WMD programs for a variety of threat countries. The primary feature is the scoping analysis of worst-case casualties relative to a strike. Reachback personnel are available 24 hours a day, 7 days a week to assess time-sensitive targets.



H-13. DTRA Consequence Management Advisory Teams provide on-site technical and scientific SMEs, planners, and hazard prediction modeling support to installation commanders, CCDRs, and federal coordinating agencies or their delegated representatives responding to catastrophic incidents involving WMD. In the commander's AOR, the consequence management advisory team provides operational consequence advice in the United States, on foreign soil, and on the battlefield.

## **ARMED FORCES RADIOBIOLOGY RESEARCH INSTITUTE**

H-14. The Armed Forces Radiobiology Research Institute can provide DOD technical-support capability for nuclear/radiological incidents or accidents. Contact the Armed Forces Radiobiology Research Institute by telephone at (301) 294-0316 or (301) 295-0530 or by fax (301) 295-0227.

## **U.S. ARMY MEDICAL RESEARCH INSTITUTE OF INFECTIOUS DISEASES**

H-15. The U.S. Army Medical Research Institute of Infectious Diseases (USAMRIID) provides medical and scientific SMEs and technical guidance to commanders and senior leaders on prevention and treatment of hazardous diseases and prevention and medical management of biological casualties. The USAMRIID serves as the DOD reference center for the identification of biological agents from clinical specimens and other sources. The USAMRIID can provide technical guidance for assessing and evaluating a biological terrorist incident, from initial communication of the threat through incident resolution. Contact the USAMRIID at (888) USA-RIID (872-7443).

## **U.S. ARMY MEDICAL RESEARCH INSTITUTE FOR CHEMICAL DEFENSE**

H-16. The U.S. Army Medical Research Institute for Chemical Defense (USAMRICD) provides medical and scientific SMEs and technical guidance to commanders and senior leaders on the prevention and treatment of chemical casualties. The USAMRICD can provide technical guidance for assessing and evaluating a chemical terrorist incident, from initial communication of the threat through incident resolution. Contact the USAMRICD at (800) 222-3277.

## **NATIONAL DOMESTIC PREPAREDNESS OFFICE**

H-17. As an office under the Federal Bureau of Investigation and the Department of Justice, the National Domestic Preparedness Office coordinates federal efforts to assist state and local first responders with planning, training, equipment, and exercises that are necessary to respond to an incident. Contact the National Domestic Preparedness Office at (202) 324-8186, Monday through Friday, 0800 to 1700 (Eastern Standard Time. The National Domestic Preparedness Office)—

- Supports functional program areas for domestic preparedness. An improved intelligence and information-sharing apparatus underpins the services provided to the federal, state, and local responder community to distribute lessons learned, asset/capabilities information, and general readiness knowledge.
- Coordinates the establishment of curriculums and standards for first-responder training to ensure consistency based on training objectives and to tailor training opportunities to meet the needs of the responder community.
- Facilitates and coordinates the efforts of the federal government to provide the responder community with the detection, protection, analysis, and decontamination equipment that is necessary to prepare for, and respond to, an incident involving WMD.
- Seeks to provide state and local governments with the resources and expertise necessary to design, conduct, and evaluate exercise scenarios involving WMD.
- Harmonizes federal, state, and local WMD preparedness planning and policy.

- Communicates information directly to the state and local emergency response community through the Internet; the law enforcement online secure computer network; special bulletins; and *The Beacon*, a monthly newsletter.
- Ensures that the health and medical community perspectives and needs are coordinated and fully incorporated into other National Domestic Preparedness Office program areas and are reflected as a priority in the overall National Domestic Preparedness Office program.

## **JOINT PROGRAM EXECUTIVE OFFICE FOR CHEMICAL AND BIOLOGICAL DEFENSE**

H-18. The JPEO-CBD is responsible for research, development, acquisition, fielding, and life-cycle support of CBRND equipment, medical countermeasures, installation protection programs, and FP systems supporting the national military strategy. The JPEO-CBD can be contacted through the JPEO-CBD Web site at <<http://www.jpeocbd.osd.mil/>>.

H-19. The JPEO-CBD maintains the Joint Acquisition CBRN Knowledge System, a web-based DOD knowledge management system for information related to the acquisition and support of CBRND products, located at <<https://jacks.jpeocbd.osd.mil/>>. The Joint Acquisition CBRN Knowledge System was established to serve the war-fighting and homeland security communities as an effective and powerful resource in quickly accessing CBRN defense product acquisition and support information.

H-20. Within the JPEO, joint project managers (JPMs) from Services lead, manage, and direct the acquisition and fielding of CB detection and reconnaissance systems; individual and collective-protection systems; decontamination systems; IM systems; medical devices, drugs, and vaccines; and installation protection programs and FP systems. As true “joint” project managers, there is no “Service lead” in developing and procuring capabilities. Each JPM is responsible to the Services for delivering required capabilities. Located throughout the United States, joint project offices leverage the talents and expertise of the Services under a single chain of command. Each JPM ensures that system developments focus on customers’ needs within cost, schedule, and performance parameters.

## **CONTAMINATION AVOIDANCE**

H-21. The JPM for NBC contamination avoidance is responsible for the development, production, testing, and fielding of CBRN detection, obscuration, and reconnaissance systems. The JPM for contamination avoidance has the additional responsibility for fielding of and training on new equipment.

H-22. The earliest possible warning is fundamental in avoiding CB agent contamination. The goal of contamination avoidance is to provide a real-time capability to detect, identify, map, quantify, and avoid CB agents in the OE, including selected TIMs.

H-23. The Chemical-Biological Defense Program pursues technologies that incorporate and integrate standoff and early warning, reconnaissance, CB point detection, and information processing. The technology focus is on increased detection sensitivity, lower detection thresholds, specificity across the evolving spectrum of threat agents, reduced false-alarm rates, and integration of detectors into various mapping and communication networks to provide common warning and reporting to the joint force.

## **BIOLOGICAL DEFENSE**

H-24. The JPM for biological defense provides defensive equipment and technology to detect and identify biological threats in near real time and collect and assimilate data for commanders who require an understanding of the biological threat situation in their AO. Their biological defensive systems are critical to the areas of CBRN sense, shield, and sustain; to meet the needs of U.S. forces; to warn personnel of imminent hazards (preattack); and to aid in the treatment of personnel exposed to a biological hazard (postattack). The JPM for biological defense covers defense systems within areas of biological point detection, standoff detection, and surveillance.

## **INDIVIDUAL PROTECTION**

H-25. The mission of the JPM for individual protection is to develop, test, procure, and field state-of-the-art garments, masks, boots, and gloves to protect the warfighter from CBRN threats and hazards. The JPM for individual protection is pursuing mask technologies that provide greater user comfort, reduce breathing resistance, and improve compatibility with combat weapon systems and suit technologies that will result in lighter, less burdensome (but equally protective) next generation suits for ground and aviation personnel. The program also pursues technology advances that improve generic CB protective filters and advances that reduce weight, volume, cost, logistics, and manpower requirements. Individual protection responsibilities include percutaneous, respiratory, and ocular protection.

## **COLLECTIVE PROTECTION**

H-26. The mission of the JPM for collective protection is to develop, procure, field, and dispose of equipment and systems that collectively protect personnel and equipment from CBRN contamination. Collective-protection equipment includes two general categories: stand-alone shelters and integrated systems that provide contamination-free, environmentally controlled surroundings for personnel to perform their missions. Collective-protection overpressure can be applied to mobile and fixed command posts, medical facilities, rest and relief shelters, buildings, fixed sites, vehicles, aircraft, and ships.

## **DECONTAMINATION**

H-27. The JPM for decontamination provides U.S. forces with the capability to sustain operations in a contaminated environment with the least amount of necessary burden and minimum degradation to mission accomplishment. This JPM provides management support for the Joint Service Family of Decontamination Systems, Joint Service Sensitive-Equipment Decontamination System, Joint Platform Interior Decontamination System, and Sorbent Decontamination System. The JPM is also poised to respond quickly to urgent-need requirements from the warfighter.

## **INFORMATION SYSTEMS**

H-28. The mission of the JPM for Information Systems is to provide the information architecture and application for shaping the OE against the CB threat. The JPM provides the warfighter with integrated early warning capability, modeling and simulation, an accredited hazard prediction model, and state-of-the-art consequence and COA analysis tools. Products include the JWARN, JEM, and JOEF.

## **GUARDIAN**

H-29. The mission of the JPM Guardian is to provide DOD prioritized installations with an integrated CBRN protection and response capability to reduce casualties, maintain critical operations, contain contamination, and effectively restore critical operations. Guardian's Installation Protection Program assists DOD in preparing for, preventing, responding to, and recovering from CBRN events by providing military installations with effective and affordable detection, identification, warning, decontamination, individual and collective protection, IM, medical surveillance, and response capabilities. JPM Guardian serves as the USA centralized manager for equipping the USA, U.S. Army Reserve, and Army National Guard civil and installation support teams. The Force Protection System Program provides affordable modular and supportable tactical FP capabilities to forward-deployed forces and state-of-the-art physical security equipment to USA installations worldwide.

## **CHEMICAL-BIOLOGICAL MEDICAL SYSTEMS**

H-30. The JPM for CB medical systems is responsible for the development, procurement, fielding, and sustainment of premier medical countermeasures against CB warfare agents and the health effects of radiation exposure. Products are submitted through the U.S. Food and Drug Administration licensing or approval processes. The Joint Project Office for Medical Systems is comprised of two Joint Product Management Offices: Joint Vaccine Acquisition Program and Medical Identification and Treatment Systems.

**This page intentionally left blank.**

## Appendix I

# U.S. Army Chemical, Biological, Radiological, and Nuclear Capabilities and Employment

This appendix provides an overview of U.S. Army Chemical Corps and related organizational capabilities that conduct CBRN operations in support of USA and joint force commanders and doctrinal employment. It provides the organizational structure, doctrinal mission, corresponding key tasks, organizational capabilities and dependencies, and tactical employment considerations for CBRN units and staffs, from platoon to theater level. In addition, this appendix incorporates the USA modular force transformation for CBRN units and staffs. Tables of organization and equipment (TOE) and tables of distribution and allowances data are specifically excluded as they may change during modular force transformation initiatives. Specific TOE or tables of distribution and allowances reference data is provided so that the user can research the latest automated, approved authorization documents on the U.S. Army Force Management Support Agency Web site at <https://webtaads.belvoir.army.mil/usafmsa/>.

## U.S. ARMY OPERATIONAL CONCEPT

I-1. The USA operational concept is full spectrum operations—the simultaneous execution of offense, defense, and stability or civil support. Commanders apply the elements of combat power through a combination of leadership, information, and the six warfighting functions. Commanders primarily conduct CBRN operations in support of the protection warfighting function, although CBRN operations also apply to the remaining warfighting functions—intelligence, movement and maneuver, C2, sustainment, and fires—to some degree. (See FM 3-0 for more information.)

## U.S. ARMY MODULAR FORCE

I-2. The USA modular force incorporates organizational CBRN capabilities into company, battalion, brigade, division, corps, and Army level echelons. Modular brigade echelons include three types: brigade combat teams, support brigades, and functional brigades. The following are the three types of brigade combat teams:

- Infantry brigade combat team (IBCT).
- Heavy brigade combat team (HBCT).
- Stryker brigade combat team (SBCT).

I-3. The following are modular support brigades:

- Maneuver enhancement brigade.
- Battlefield surveillance brigade.
- Sustainment brigade.
- Combat aviation brigade.
- Fires brigade.

I-4. Finally, there are various functional brigades, to include the CBRN brigade. (See FM 3-0 for more information on USA modular organizations and employment.)

## CHEMICAL, BIOLOGICAL, RADIOLOGICAL, AND NUCLEAR OPERATIONAL CONCEPT

I-5. The USA Chemical Corps’ operational concept is to conduct CBRN operations in support of combating WMD and the protection warfighting function by employing platoon-size CBRN forces and specialized technical elements or teams, task-organized to an appropriate CBRN or other C2 headquarters.

## MODULAR CHEMICAL, BIOLOGICAL, RADIOLOGICAL, AND NUCLEAR FORCES

I-6. The USA Chemical Corps maintains three major force capabilities: CBRN units, CBRN staffs, and specialized teams and task forces. (See figure I-1 for the three categories.)

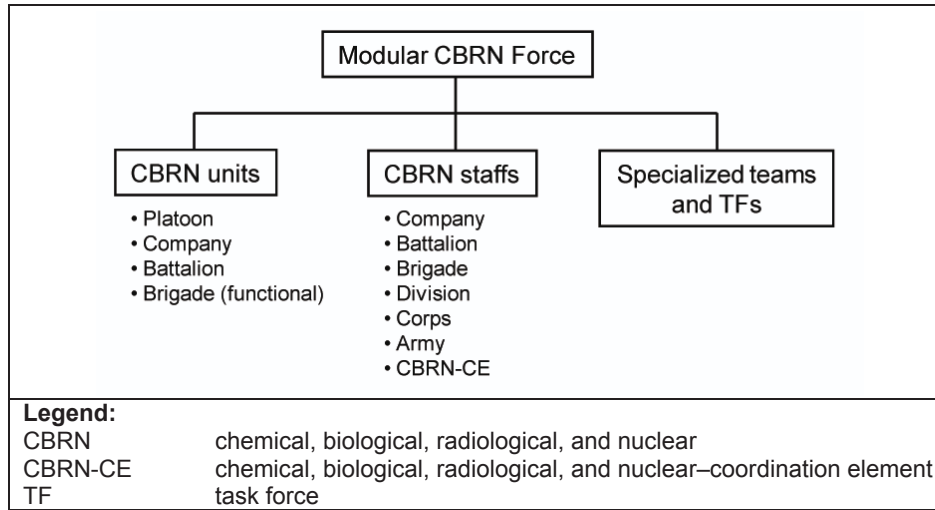

**Figure I-1. Major force capabilities**

I-7. The USA Chemical Corps CBRN units include platoon, company, battalion, functional brigade, and special operations organizations. This diverse group provides a CBRN operational capability that is tailored with functional and multifunctional units to protect the force from CBRN threats and hazards during the conduct of full spectrum operations (USA) and during joint operations.

I-8. The USA Chemical Corps supports the USA modular force design by incorporating staff personnel in a combination of CBRN officers, CBRN NCOs, and/or CBRN specialists at the company, battalion, brigade, division, corps, and Army service component command echelons. In addition, the CBRN coordination element (CBRN-CE) provides staff augmentation to Army Service Component Command echelons.

I-9. The USA also provides a number of additional specialized capabilities to support CBRN operations, to include a CBRNE operational headquarters, special operating forces, and medical and civil support. These are discussed in more detail later in this appendix.

## CHEMICAL, BIOLOGICAL, RADIOLOGICAL, AND NUCLEAR UNITS IN THE MODULAR FORCE

I-10. CBRN units support land-based operations from the platoon to brigade level and also support special operations. The platoon is the functional unit module for CBRN passive defense and battlefield obscuration. CBRN platoons are organized as organic assets to brigade combat teams (CBRN reconnaissance platoons) or to CBRN companies. The CBRN company is the smallest CBRN operational unit that has its own dedicated TOE. (See figure I-2 for the various CBRN operational units.)

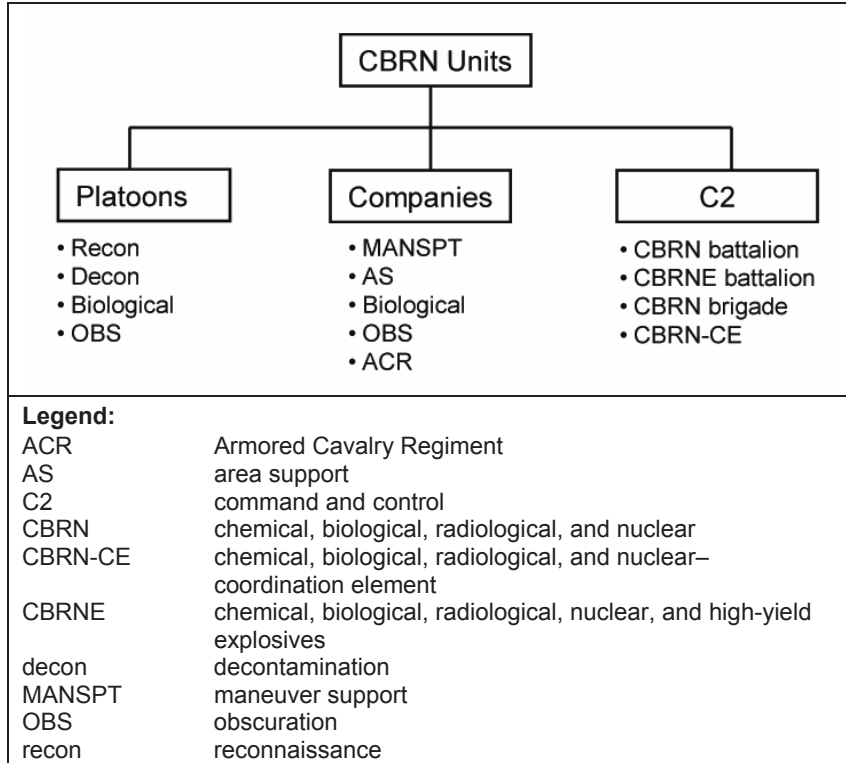

Figure I-2. USA Chemical Corps CBRN operational units

## CHEMICAL, BIOLOGICAL, RADIOLOGICAL, AND NUCLEAR RECONNAISSANCE PLATOONS

I-11. The USA Chemical Corps maintains multiple variants of the CBRN reconnaissance platoon in the modular force design. The platoons vary by mission, crew size, assigned equipment, and mobility platform. If organic to the brigade combat teams, they are assigned to the brigade special troops battalion for IBCTs and HBCTs, or to the reconnaissance, surveillance, and target acquisition squadron in the SBCT.

I-12. CBRN reconnaissance platoons fall into two general categories—light and armored. The light CBRN reconnaissance platoons employ a light or up-armored wheeled platform (for example, a high-mobility, multipurpose, wheeled vehicle) and are organic to the IBCT with two crews and to the the CBRN company (area support) with six crews. The armored CBRN reconnaissance platoons employ an armored wheeled platform (for example, M93-series Fox or Stryker NBC reconnaissance vehicle) and are organic to the HBCT with two crews, SBCT with three crews, and CBRN company (maneuver support [MANSPT]) with six crews. (See figures I-3 through I-7, pages I-4 through I-8, for more information on CBRN reconnaissance platoons.)



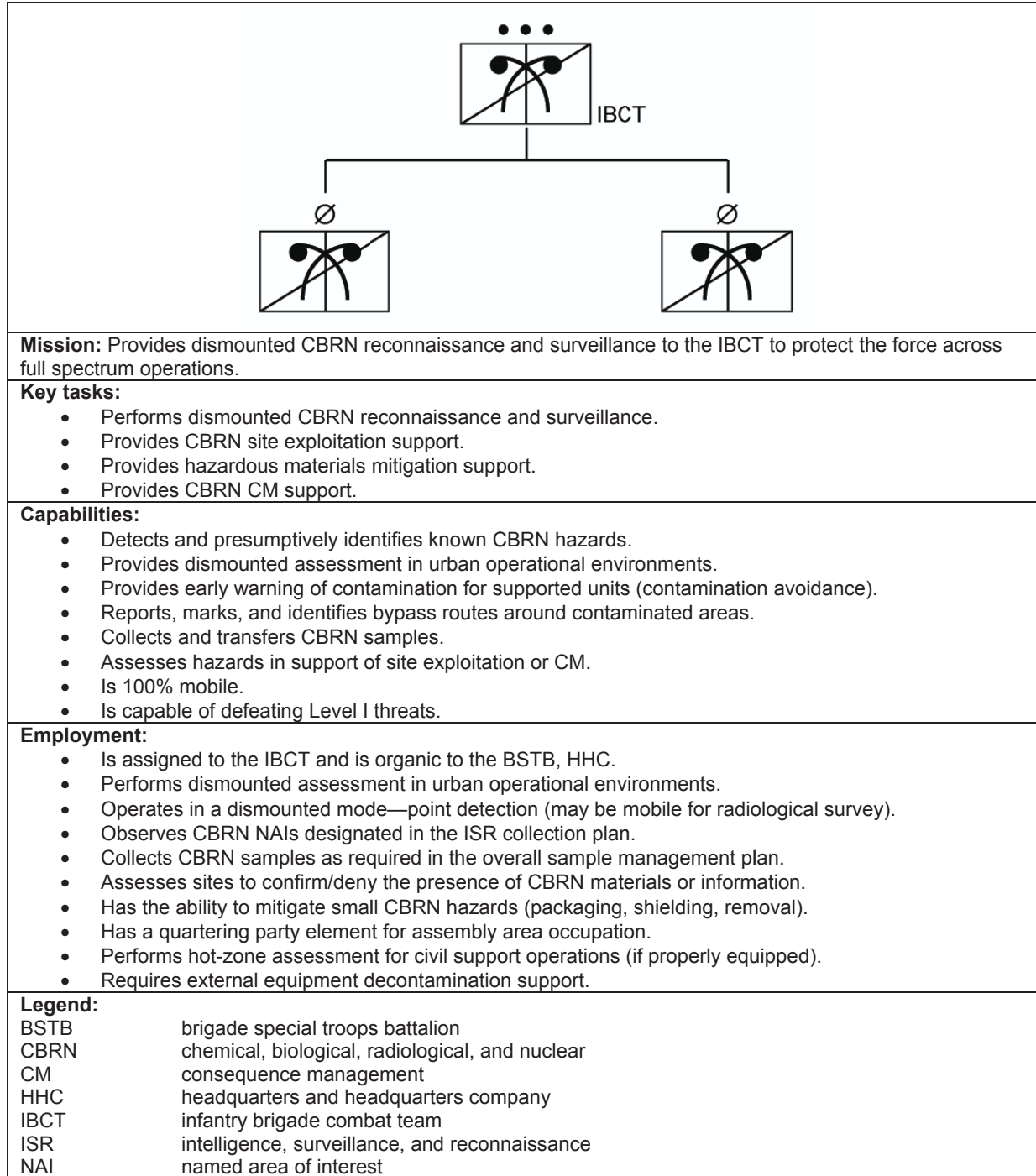

Figure I-3. CBRN reconnaissance platoon (ICBT) (TOE 77406G100)

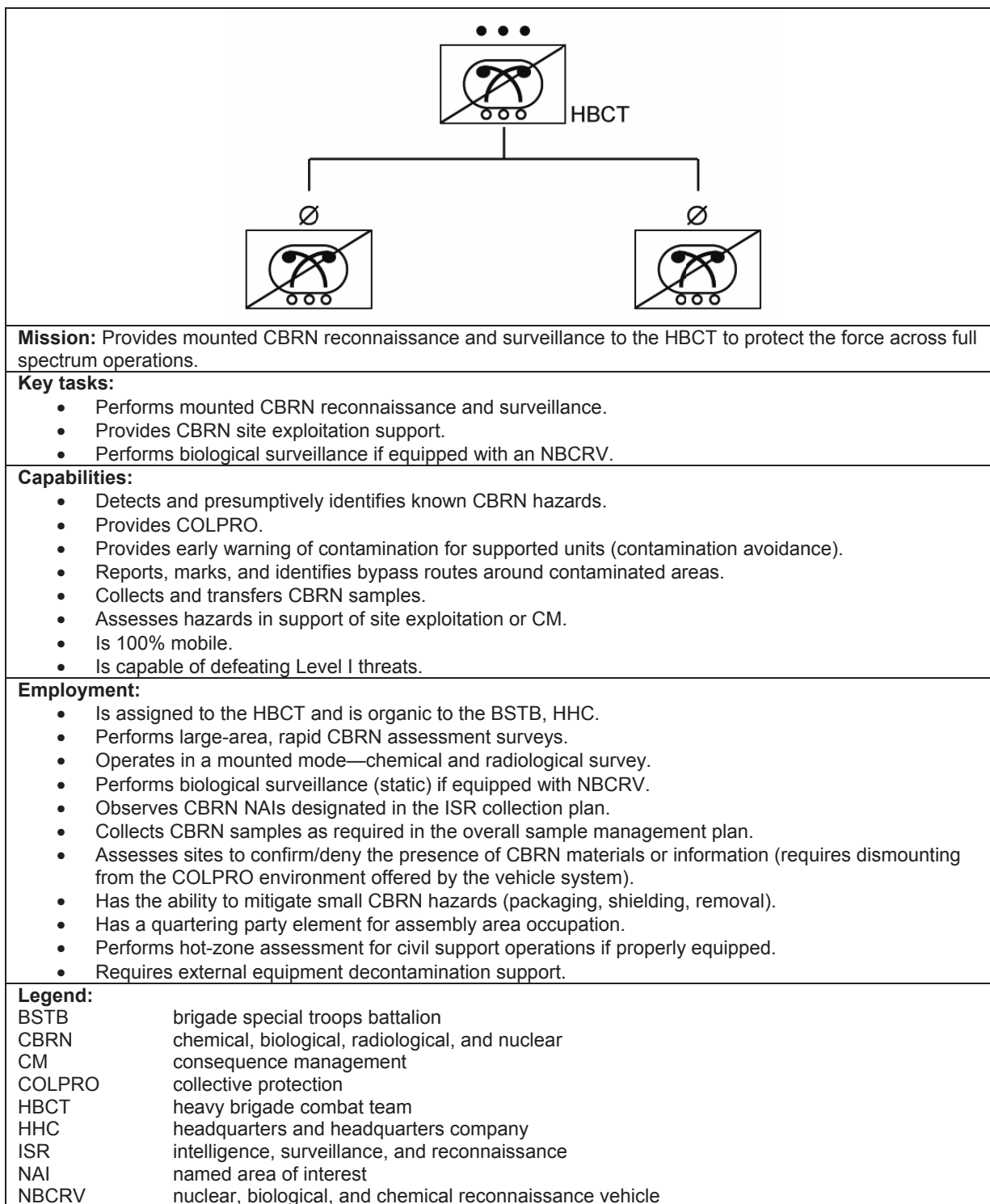

Figure I-4. CBRN reconnaissance platoon (HBCT) (TOE 87306G300)

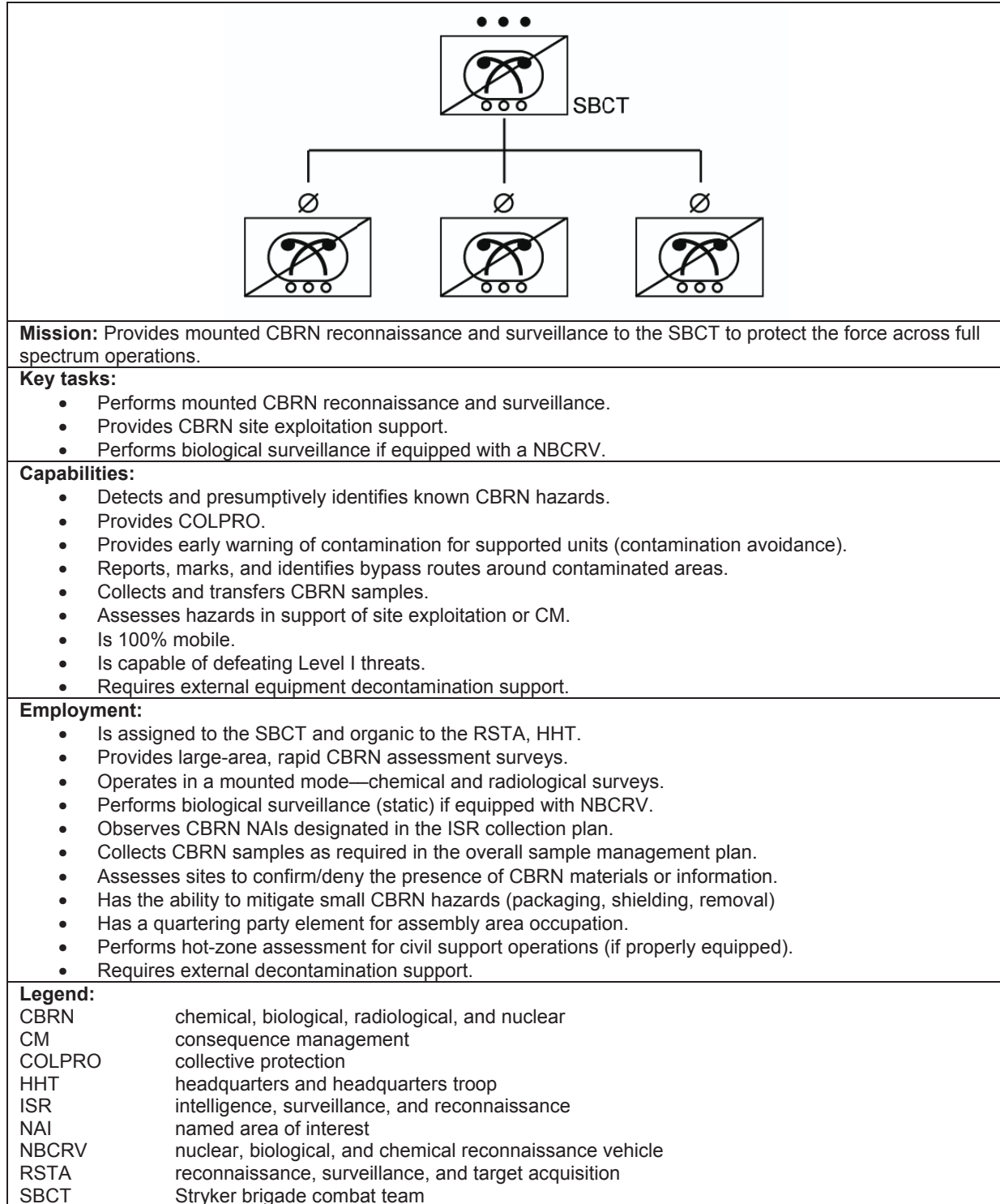
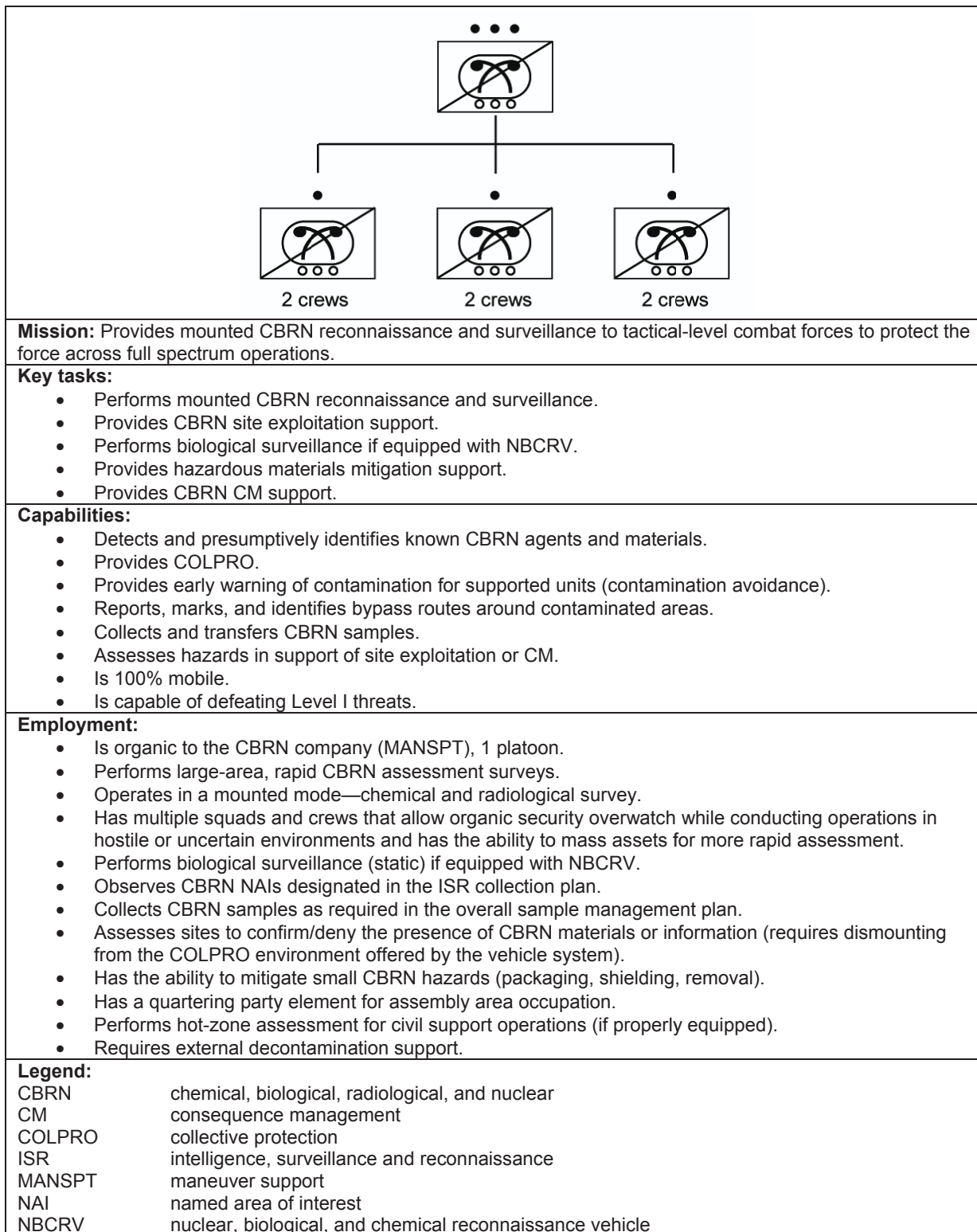

Figure I-5. CBRN reconnaissance platoon (SBCT) (TOE 34117F300)



**Figure I-6. CBRN reconnaissance platoon (armored) (TOE 03599FG00)**

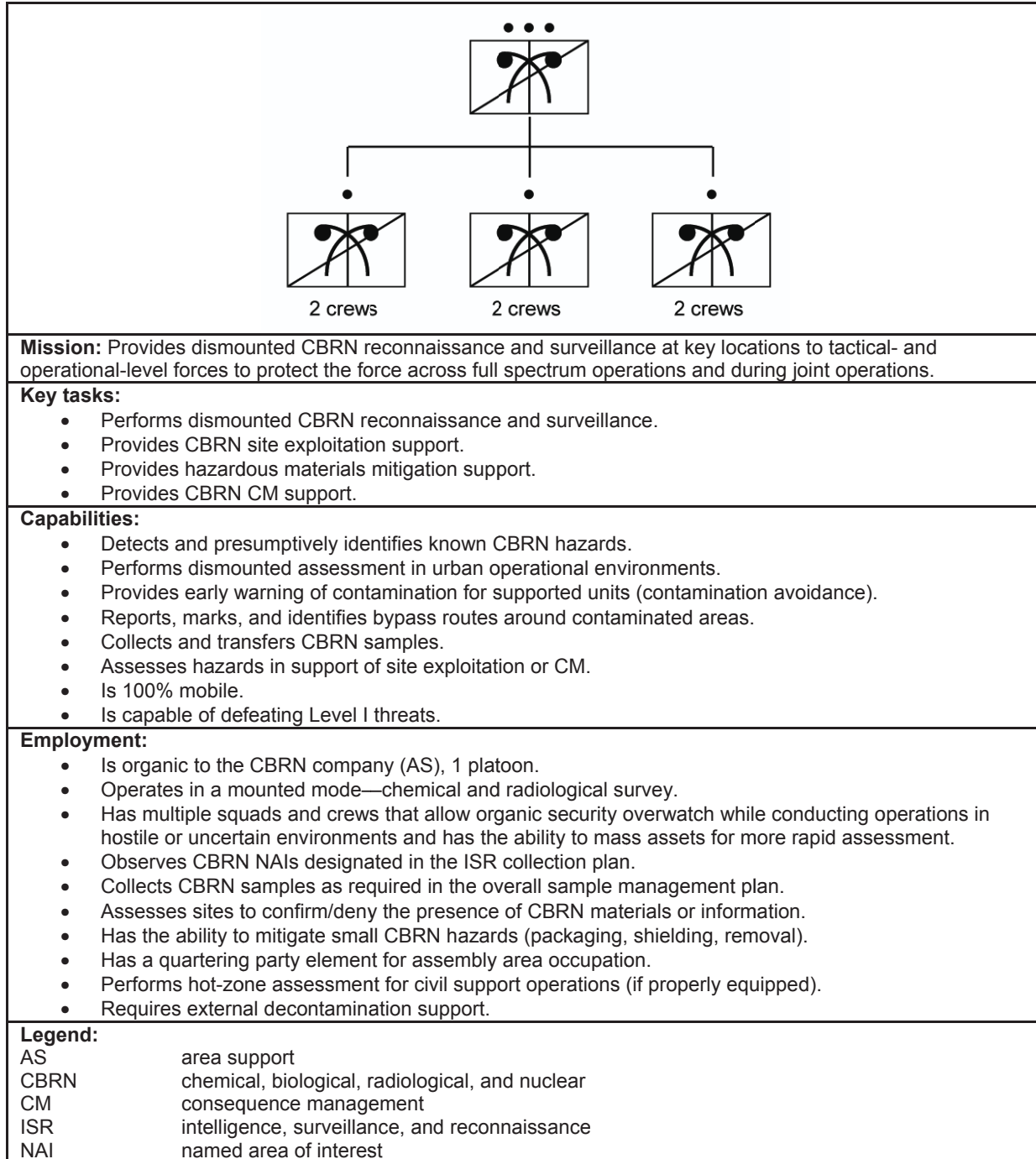
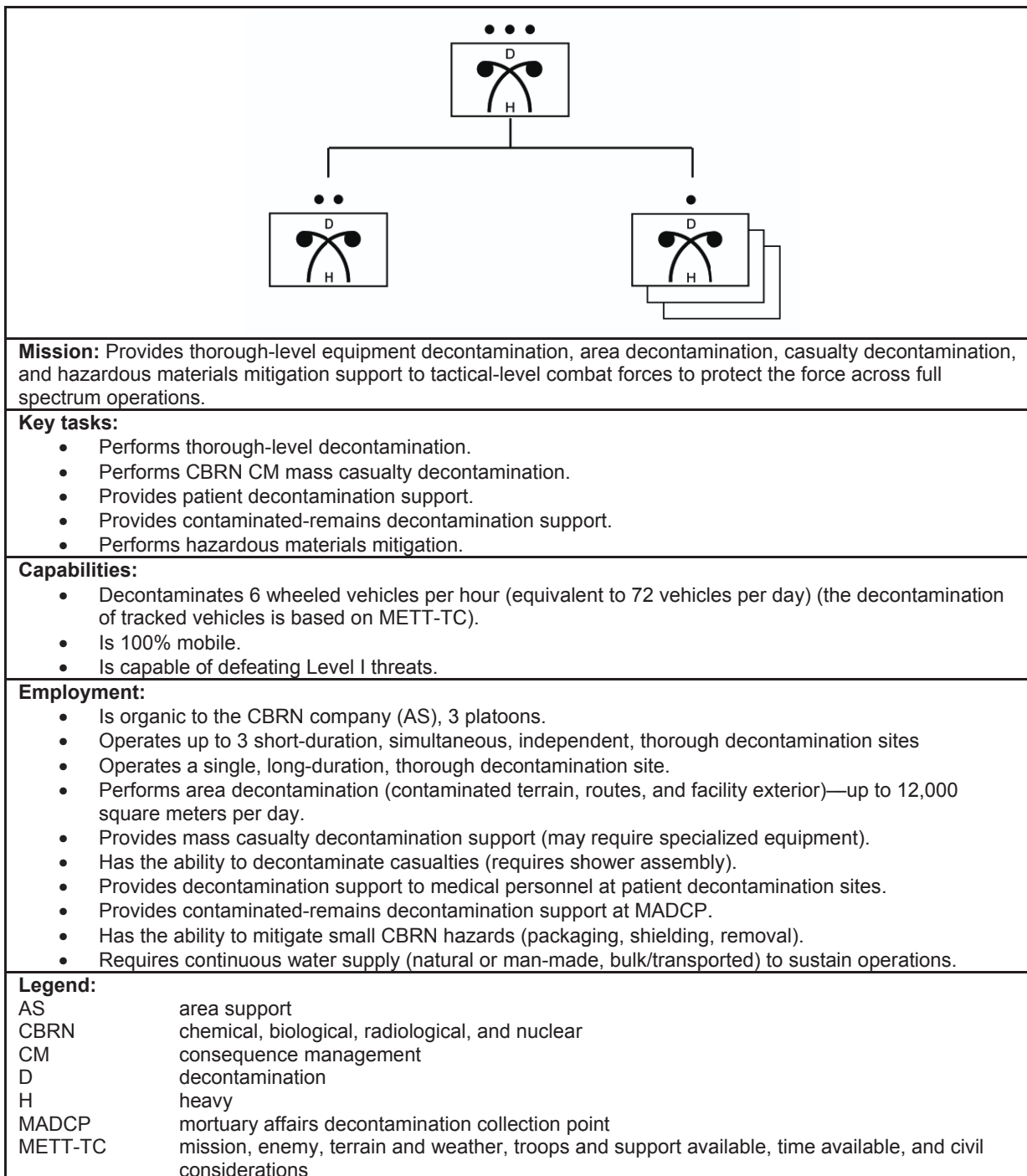

Figure I-7. CBRN reconnaissance platoon (light) (TOE 03599FN00)

## CHEMICAL, BIOLOGICAL, RADIOLOGICAL, AND NUCLEAR DECONTAMINATION PLATOONS

I-13. The USA Chemical Corps maintains two variants of the CBRN decontamination platoon in the modular force design. The two are identical in personnel, strength, and organizational structure. The primary difference lies with the tactical employment of each based on the type of decontamination equipment employed by the squads—one variant is heavy, and the other variant is light.

I-14. The heavy CBRN decontamination platoon provides thorough-level decontamination as its primary mission to the supported force. It is also the principal capability for area decontamination, to include terrain, routes, and fixed sites. (See figure I-8 for more information on the CBRN decontamination platoon [heavy].)



**Figure I-8. CBRN decontamination platoon (heavy) (TOE 03599FI00)**

I-15. The light CBRN decontamination platoon provides operational-level decontamination to the supported force as its primary mission. It is also the primary capability for USA aircraft decontamination. (See figure I-9, page I-10, for more information on the CBRN decontamination platoon [light].)

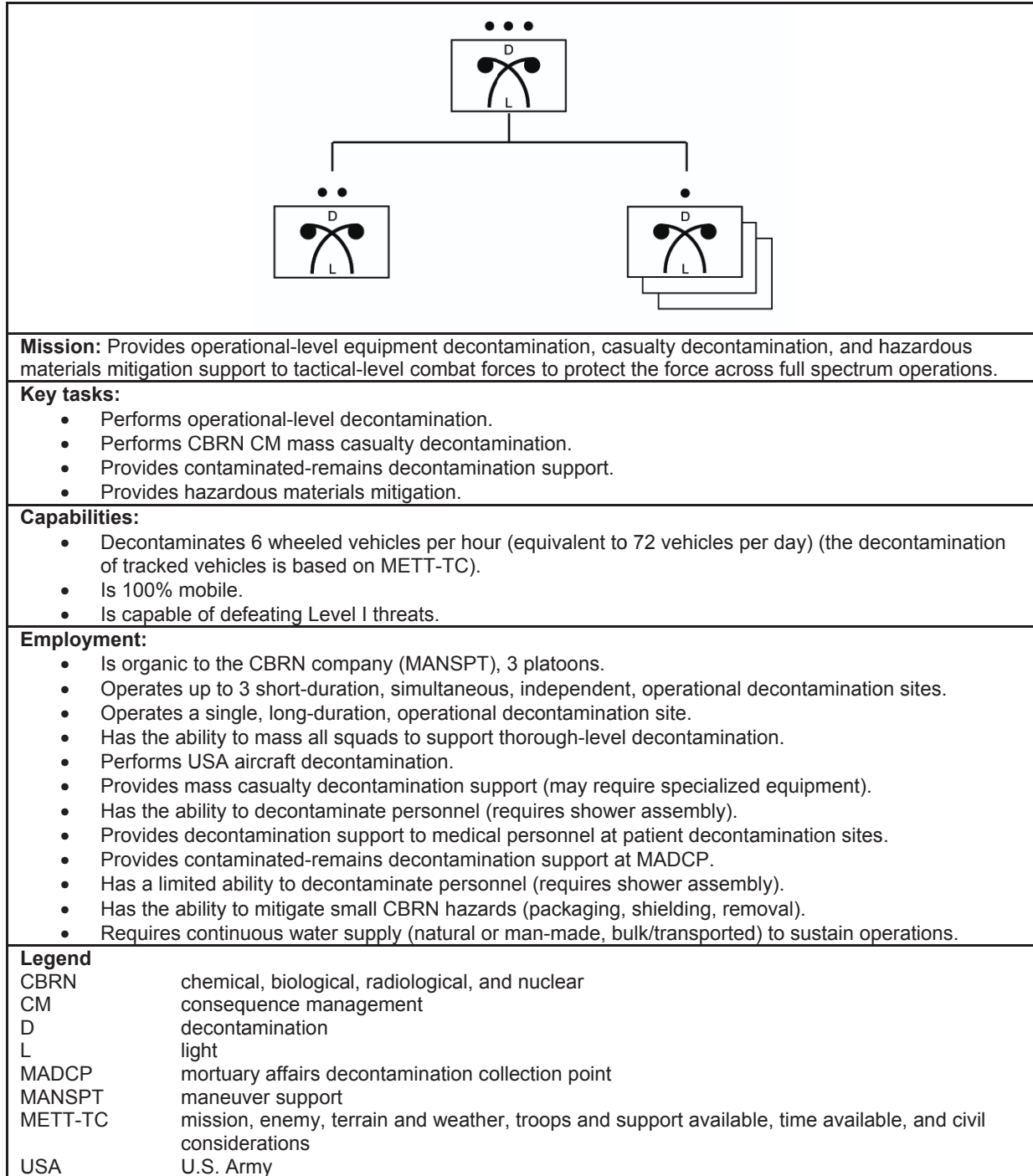

Figure I-9. CBRN decontamination platoon (light) (TOE 03599FH00)



## **EQUIPMENT DECONTAMINATION**

I-16. The primary mission of decontamination platoons is military equipment decontamination at the operational and thorough levels. Some equipment (USA aircraft, sensitive equipment) requires unique decontamination planning and execution. (See *Multiservice Tactics, Techniques, and Procedures for Chemical, Biological, Radiological, and Nuclear Decontamination* for more information.)

## **PERSONNEL AND CASUALTY DECONTAMINATION**

I-17. CBRN decontamination platoons have an organic capability to decontaminate personnel by employing an accessory shower assembly (if equipped).

I-18. Some CBRN decontamination platoons may even be equipped with mass casualty decontamination systems similar to those used by civil authorities. Such equipment is generally limited to civil support mass casualty decontamination and the process is best conducted under medical supervision. (See *Multiservice Tactics, Techniques, and Procedures for Chemical, Biological, Radiological, and Nuclear Consequence Management Operations* for more information on mass casualty decontamination.)

## **PATIENT DECONTAMINATION**

I-19. CBRN decontamination platoons may support medical operations by augmenting designated patient decontamination sites according to the HSS plan. (See FM 4-02.7 for more information.)

## **CONTAMINATED-REMAINS DECONTAMINATION**

I-20. CBRN decontamination platoons may support mortuary affairs operations by providing augmentation to contaminated-remains decontamination at the designated mortuary affairs decontamination collection point. (See JP 3-06 for more information.)

## **CHEMICAL, BIOLOGICAL, RADIOLOGICAL, AND NUCLEAR PLATOONS (BIOLOGICAL)**

I-21. The USA Chemical Corps maintains biological platoons that employ Biological Integrated Detection Systems in a surveillance mode of operation. The biological platoon is organized with a platoon headquarters and subordinate biological teams.

I-22. Biological platoons may operate in an area array configuration to protect key troop concentrations (reception, staging, onward movement, integration, staging, tactical assembly areas). They may also operate in a critical node configuration to protect installations, key C2 facilities, or other strategic sites. (See figure I-10, page I-12, for more information on the CBRN platoon [biological].)

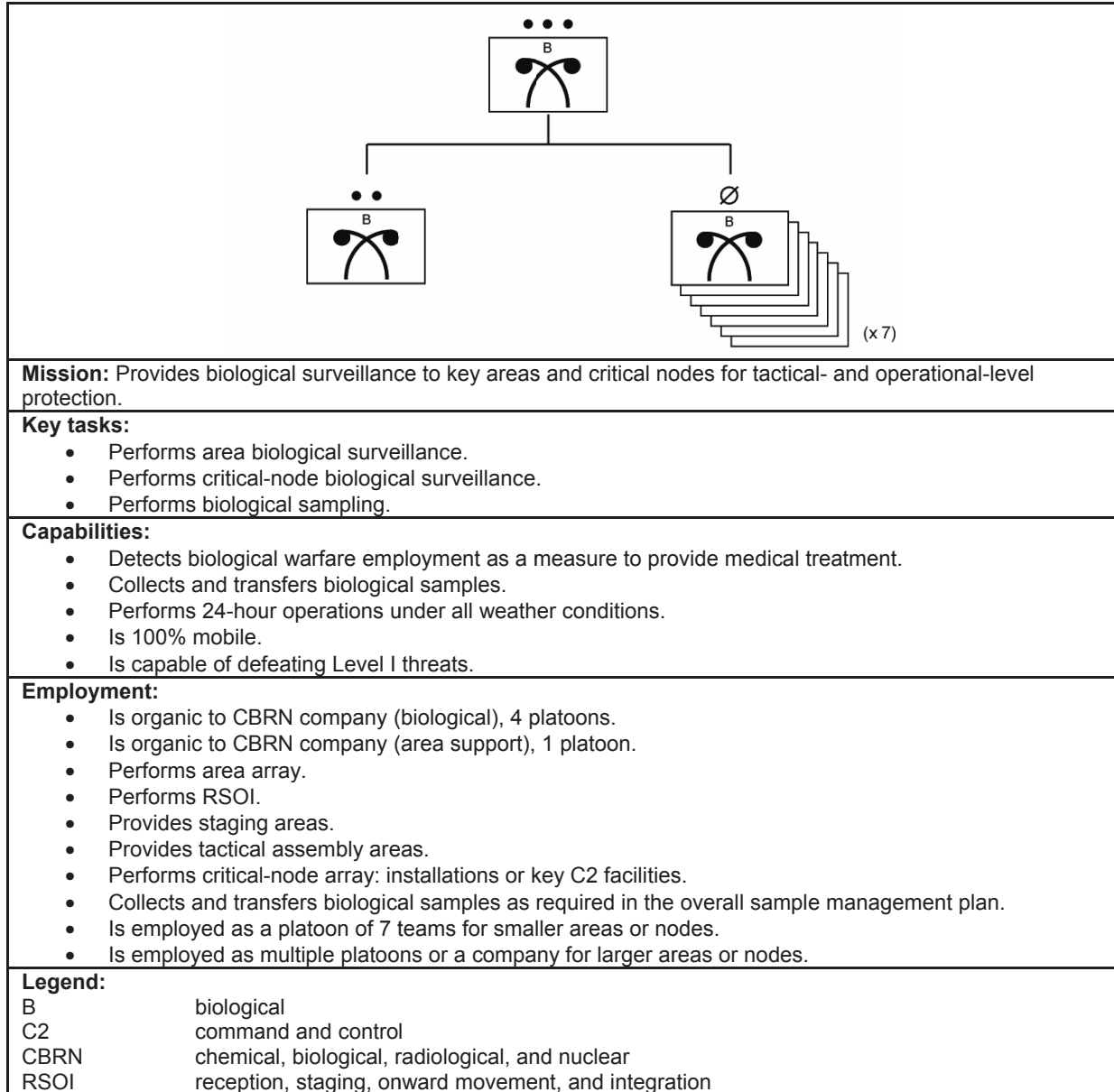

Figure I-10. CBRN platoon (biological) (TOE 03599FL00)

## CHEMICAL, BIOLOGICAL, RADIOLOGICAL, AND NUCLEAR PLATOONS (OBSCURATION)

I-23. The USA Chemical Corps maintains two variants of the CBRN obscuration platoon in the modular force design. The primary difference lies with the mobility platform—one variant is mechanized, and the other variant is wheeled. Each platoon is organized with a platoon headquarters section and two squads, with a third squad operating as the support element. Obscuration platoons provide large-area obscuration to protect the supported force and enable movement and maneuver. CBRN obscuration platoons typically provide temporary obscuration for single, short-term missions. They may also provide sustained obscuration by integrating on-line fog oil resupply into the operation. Obscurants include visual- or infrared-defeating obscuration or a combination of the two. (See FM 3-11.50 for more information.)

I-24. Mechanized obscuration platoons operate primarily in support of brigade combat teams due to their greater survivability and rough-terrain mobility capability. Wheeled obscuration platoons operate primarily

in support of division and echelons above division due to their limited survivability and rough terrain mobility capability. (See figures I-11 and I-12, page I-14, for more information on the CBRN platoons [obscurator] [mechanized and wheeled].)

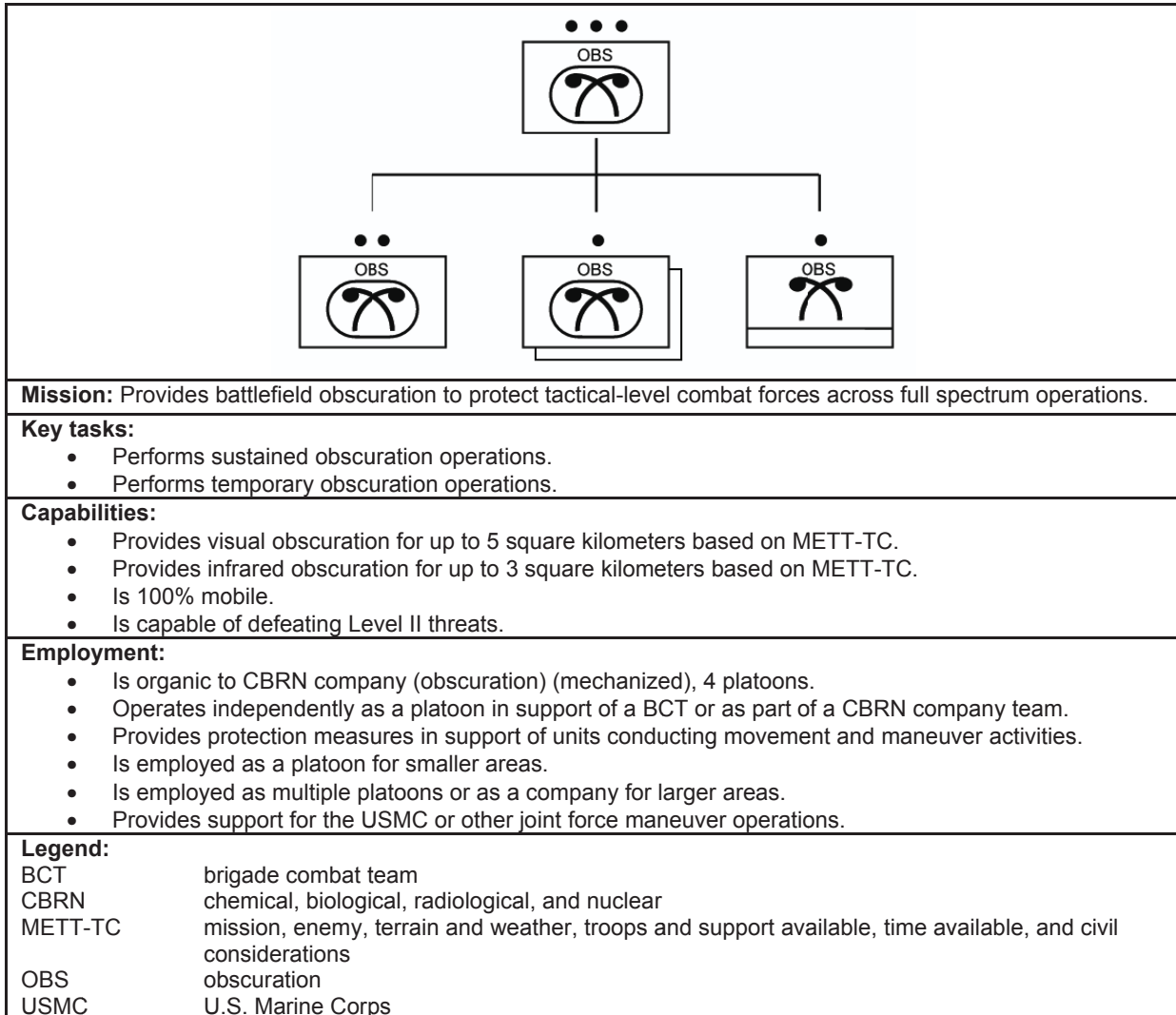

**Figure I-11. CBRN platoon (obscurator) (mechanized) (TOE 03599FJ00)**

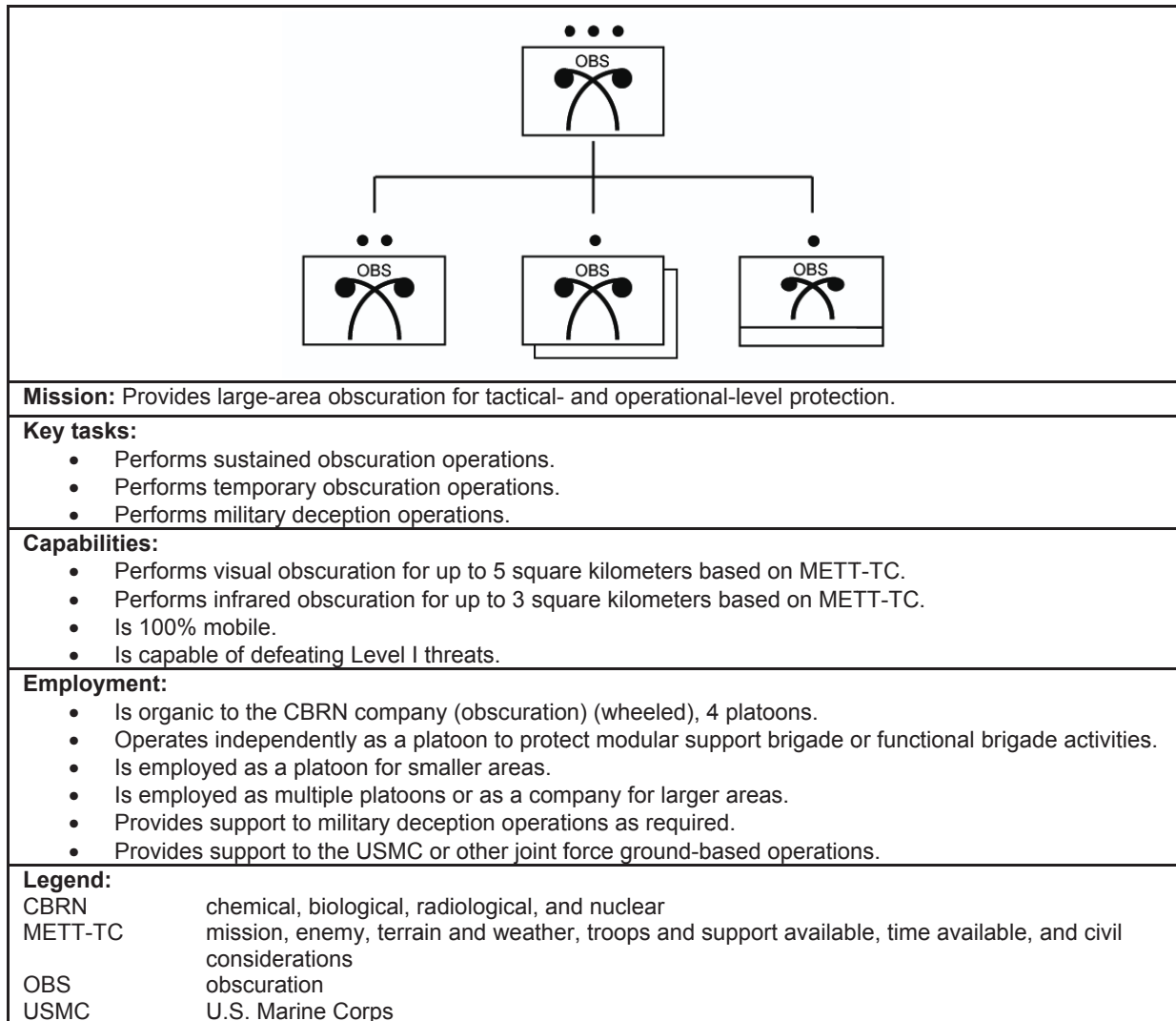

**Figure I-12. CBRN platoon (obscurator) (wheeled) (TOE 03599FK00)**

## CHEMICAL, BIOLOGICAL, RADIOLOGICAL, AND NUCLEAR COMPANY (MANEUVER SUPPORT)

I-25. The CBRN company (MANSPT) provides command, control, and sustainment support to its subordinate CBRN reconnaissance and decontamination platoons and any additional attachments. (See figure I-13 for more information on the CBRN company [MANSPT].)

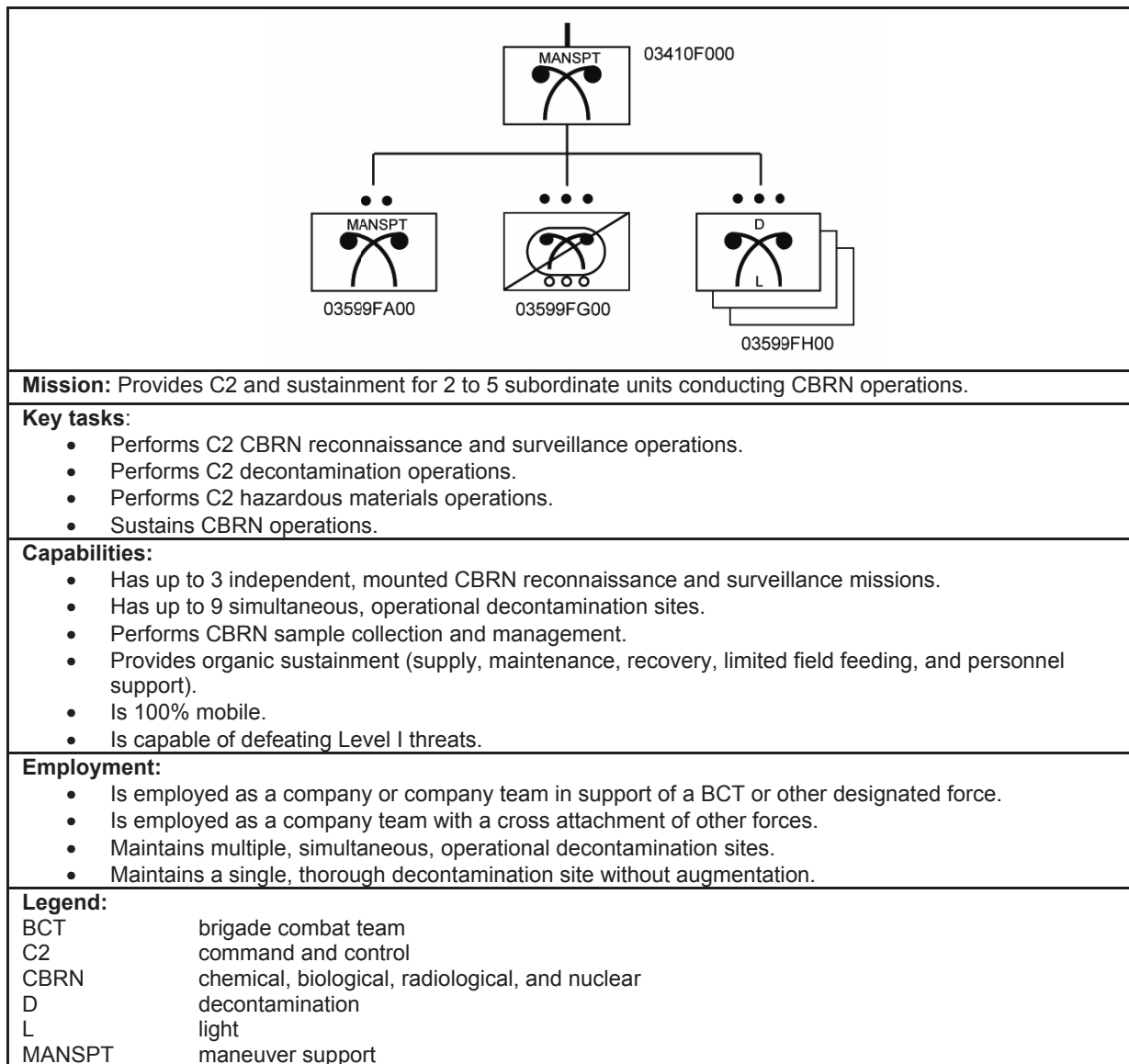

Figure I-13. CBRN company (MANSPT) (TOE 03410F000)

## CHEMICAL, BIOLOGICAL, RADIOLOGICAL, AND NUCLEAR COMPANY (AREA SUPPORT)

I-26. The CBRN company (area support) provides C2 and sustainment support to its subordinate CBRN reconnaissance, decontamination, and biological platoons and any additional attachments. (See figure I-14, page I-16, for more information on the CBRN company [area support].)

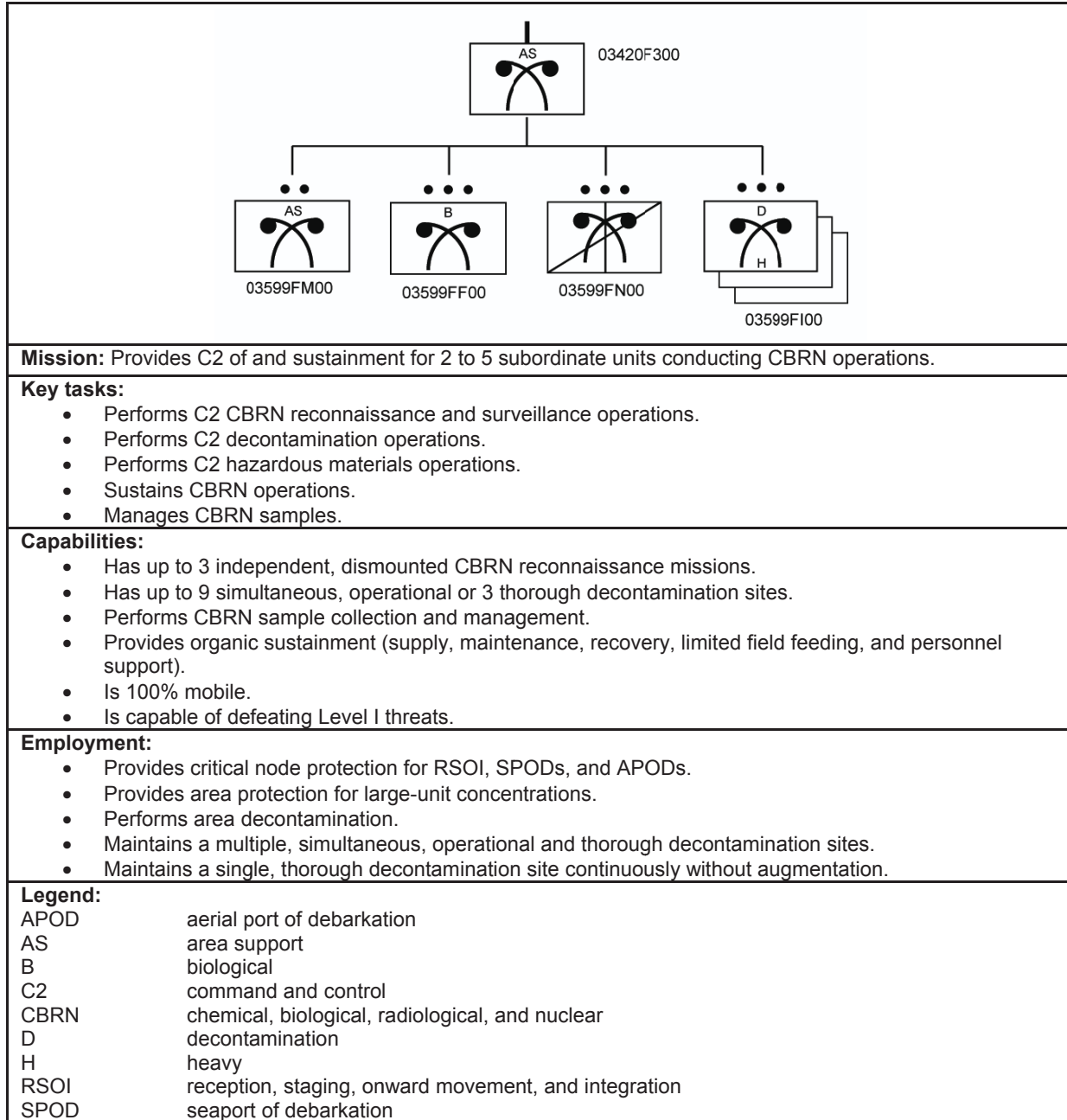
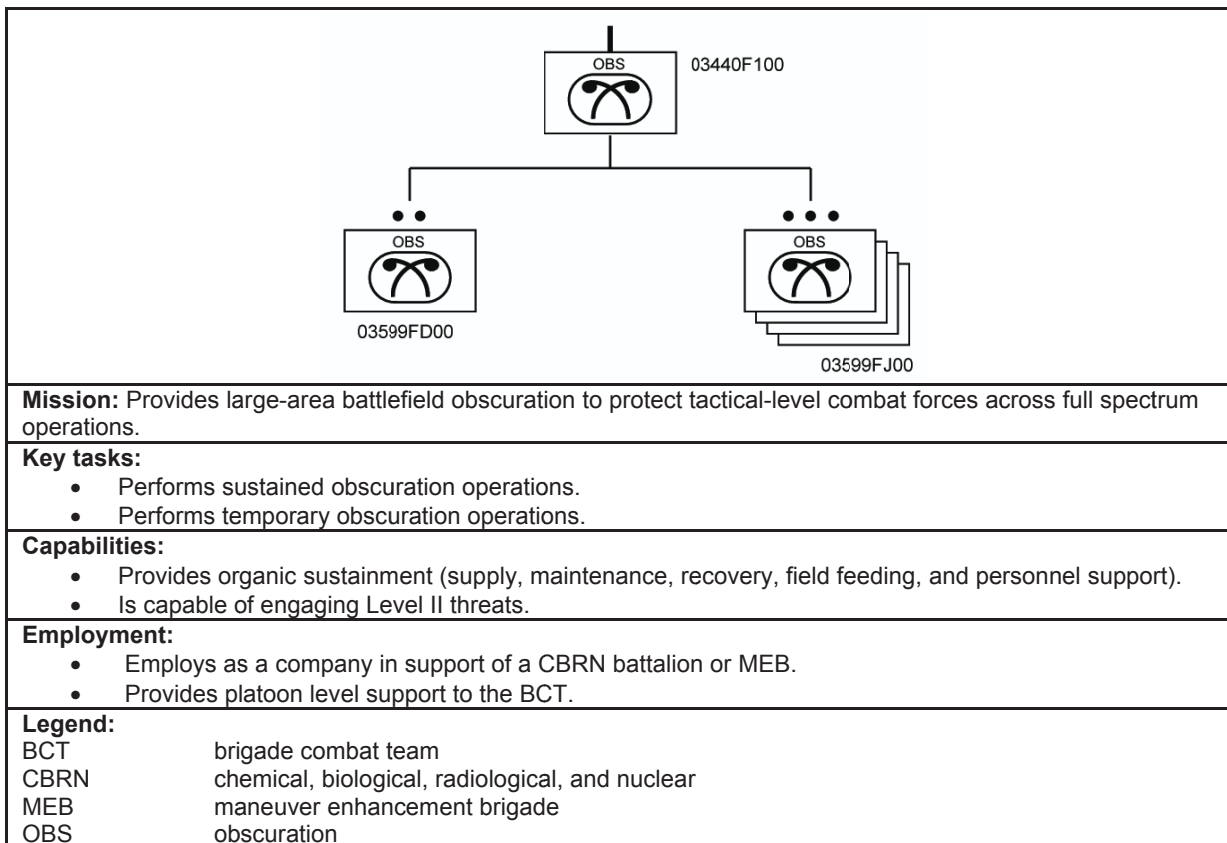

Figure I-14. CBRN company (area support) (TOE 03420F300)

## CHEMICAL, BIOLOGICAL, RADIOLOGICAL, AND NUCLEAR COMPANY (OBSCURATION)

I-27. The U.S. Army maintains its large-area obscuration platoon force by pooling into company formations. This force pooling allows massing the protection effects on a large scale or task-organizing platoon-size obscuration units to support combat formations, provide obscuration support to the other Services, or operate in support of other missions (protection of key C2, sustainment functions [fog oil resupply, vehicle maintenance, vehicle recovery]). (See FM 3-11.50 for more information on battlefield obscuration.)

I-28. The CBRN company (obscurator) (mechanized) provides large-area obscurator support to heavy maneuver forces, given the protection capability afforded by its system platform. The company may be directed to support operations at the division or higher level or to task-organize its platoon to support BCTs or other missions on a smaller scale. (See figure I-15 for more information on the CBRN company [obscurator] [mechanized].)



**Figure I-15. CBRN company (obscurator) (mechanized) (TOE 03440F100)**

I-29. The CBRN company (obscurator) (wheeled) provides large-area obscurator support to light maneuver forces or is in support to other Services if a mechanized capability is not required given the nature of the operational environment. The company may be directed to support operations at the division or higher level gap crossing or to task-organize its platoons to support BCTs or other missions on a smaller scale. (See figure I-16, page I-18 for more information on the CBRN company [obscurator] [wheeled].)



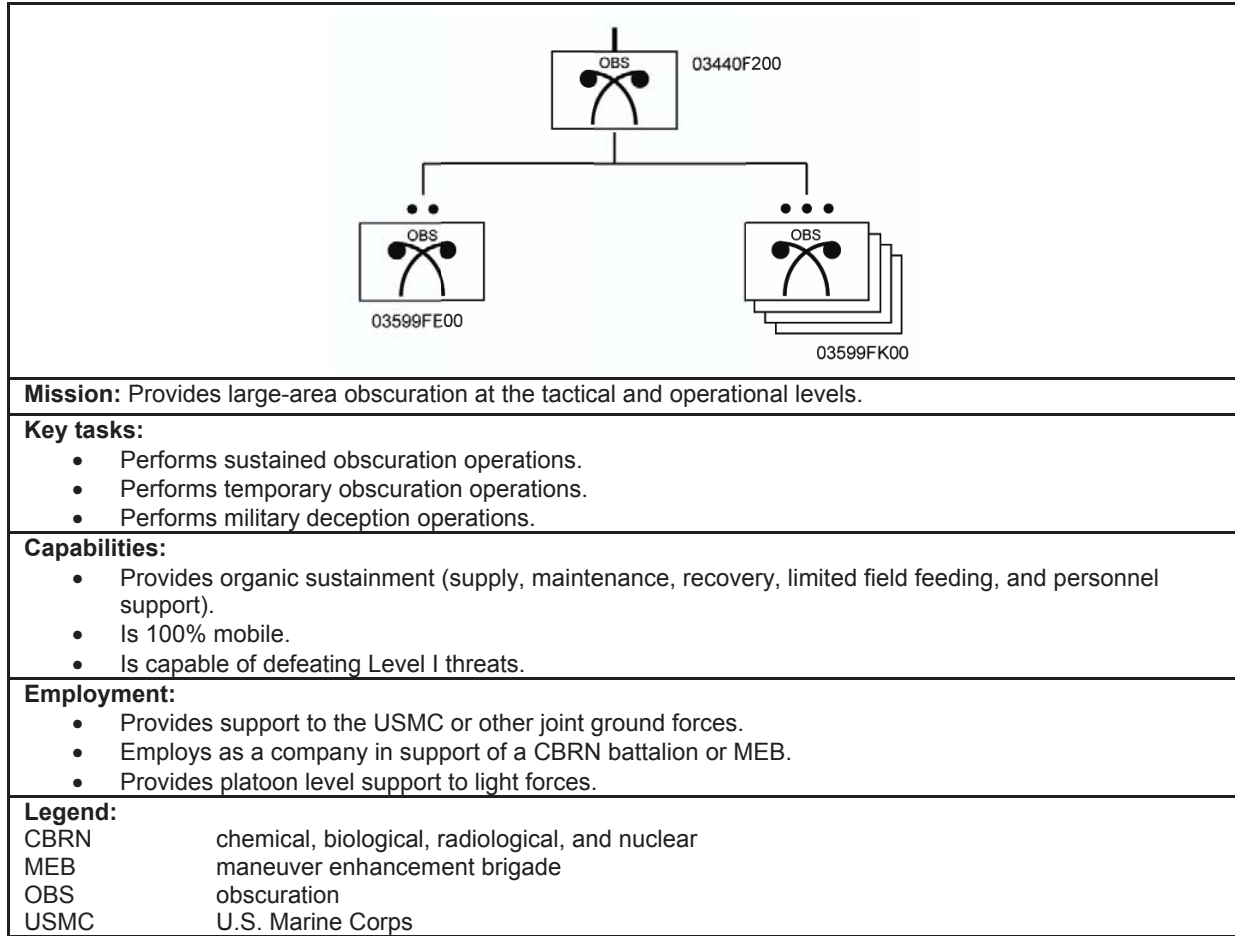
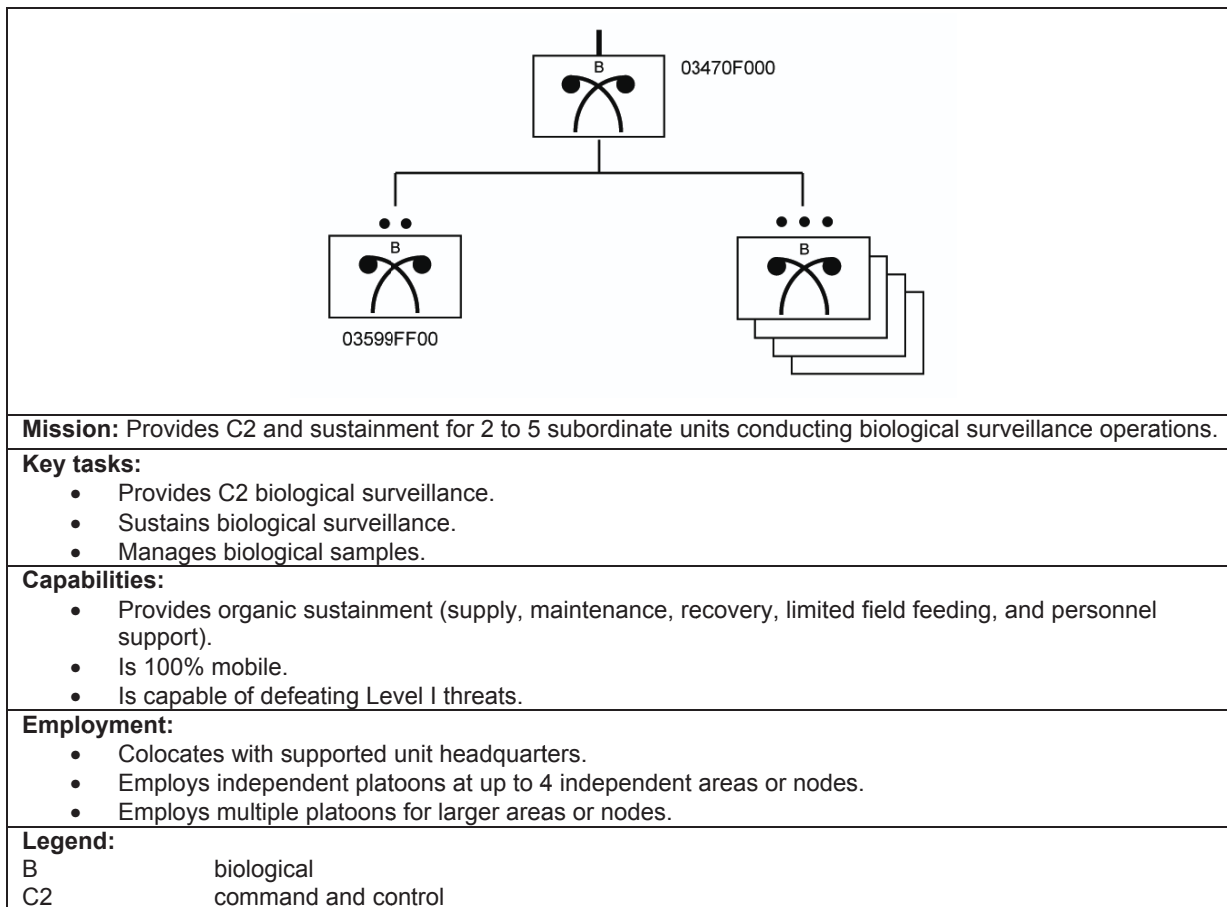

Figure I-16. CBRN company (obscurator) (wheeled) (TOE 03440F200)

## CHEMICAL, BIOLOGICAL, RADIOLOGICAL, AND NUCLEAR COMPANY (BIOLOGICAL)

I-30. The biological company provides command, control, and sustainment support to its subordinate biological platoons. The CBRN company (biological) provides the ability to conduct biological surveillance simultaneously across multiple areas or at multiple critical nodes, or it can mass platoons for larger-area coverage. (See figure I-17 for more information on the CBRN company [biological].)



**Figure I-17. CBRN company (biological) (TOE 03470F000)**

## **CHEMICAL, BIOLOGICAL, RADIOLOGICAL, AND NUCLEAR COMPANY (ARMORED CAVALRY REGIMENT)**

I-31. The USA Chemical Corps maintains a CBRN company in support of the Armored Cavalry Regiment. This company represents the most diverse of the organizational designs, a direct reflection of the diversity in the unit it supports. The company provides mobile CBRN reconnaissance and large-area obscuration or CBRN decontamination (it cannot conduct both simultaneously) support to the Armored Cavalry Regiment. The mobile CBRN reconnaissance platoon includes six mobile CBRN reconnaissance platforms (M93A1 Fox NBC Reconnaissance System or NBC reconnaissance vehicle). The obscuration platoon is mechanized, with six M58 large-area obscuration platforms organized into two squads. The third squad in the obscuration platoon is dual-designated as a support decontamination squad, with one heavy decontamination apparatus. (See figure I-18, page I-20, for more information on the CBRN company [Armored Cavalry Regiment].)

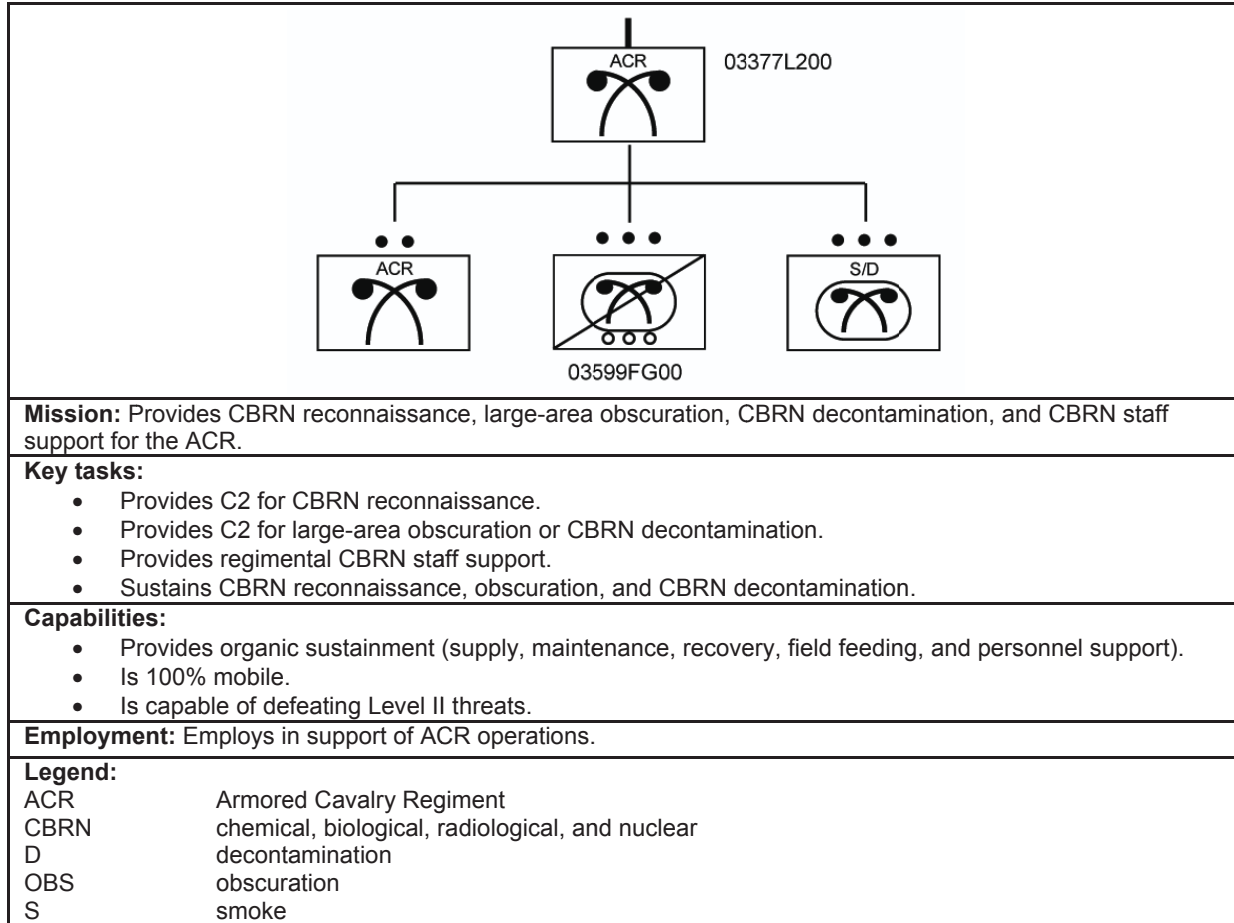

Figure I-18. CBRN company (Armored Cavalry Regiment) (TOE 03377L200)

## CHEMICAL, BIOLOGICAL, RADIOLOGICAL, AND NUCLEAR COMMAND AND CONTROL UNITS

I-32. The USA Chemical Corps maintains two CBRN C2 echelons: battalion and brigade. These two C2 headquarters provide intermediate CBRN C2 capabilities for divisions or at echelons above division. These organizations provide the supported command with the capacity to mass the effects of CBRN units and capabilities at decisive locations or times on the battlefield.

### CHEMICAL, BIOLOGICAL, RADIOLOGICAL, AND NUCLEAR BATTALION

I-33. The CBRN battalion is a stand-alone headquarters whose mission is to provide C2 for up to seven CBRN companies or equivalent CBRN elements. The battalion is typically employed in support of a division or at echelons above division. Its command and support relationships may include attached, operational control, or direct support, depending on the factors of METT-TC. It may also be task-organized to a CBRN brigade, an MEB, or as an independent CBRN battalion to a CBRNE operational headquarters. (See figure I-19 for more information on the CBRN battalion.)

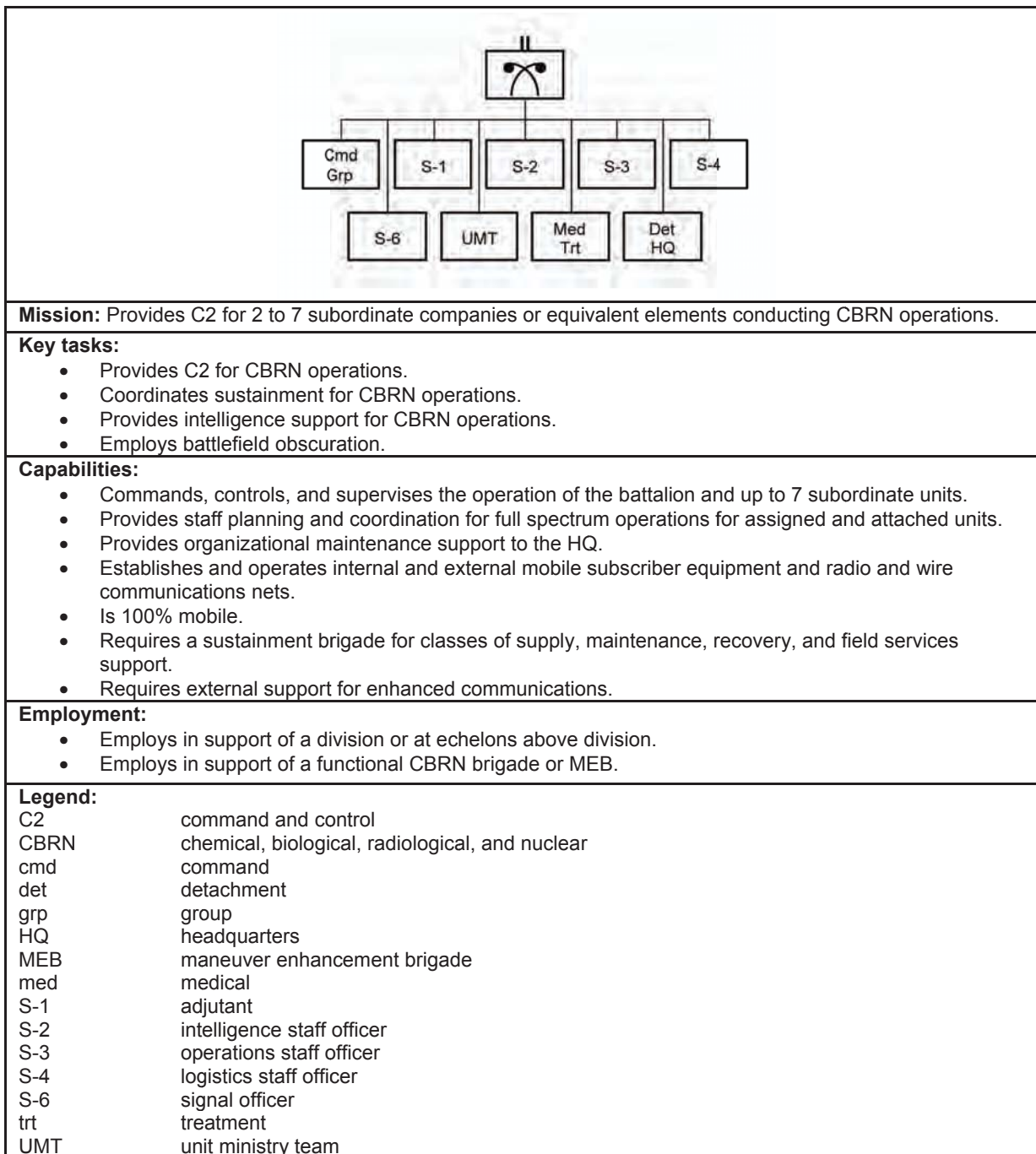

Figure I-19. CBRN battalion (TOE 03496F000)

### CHEMICAL, BIOLOGICAL, RADIOLOGICAL, AND NUCLEAR BRIGADE HEADQUARTERS

I-34. The CBRN brigade is one of the USA modular functional brigades. It is a stand-alone headquarters whose mission is to provide C2 for up to six CBRN battalions. The brigade is typically employed in support of a corps or at echelons above corps at the theater Army or JTF level. The CBRN brigade is typically employed to provide C2 for critical theater sustainment operations or to employ tactical WMD elimination capabilities. (See figure I-20, page I-22, for more information on the CBRN brigade headquarters.)

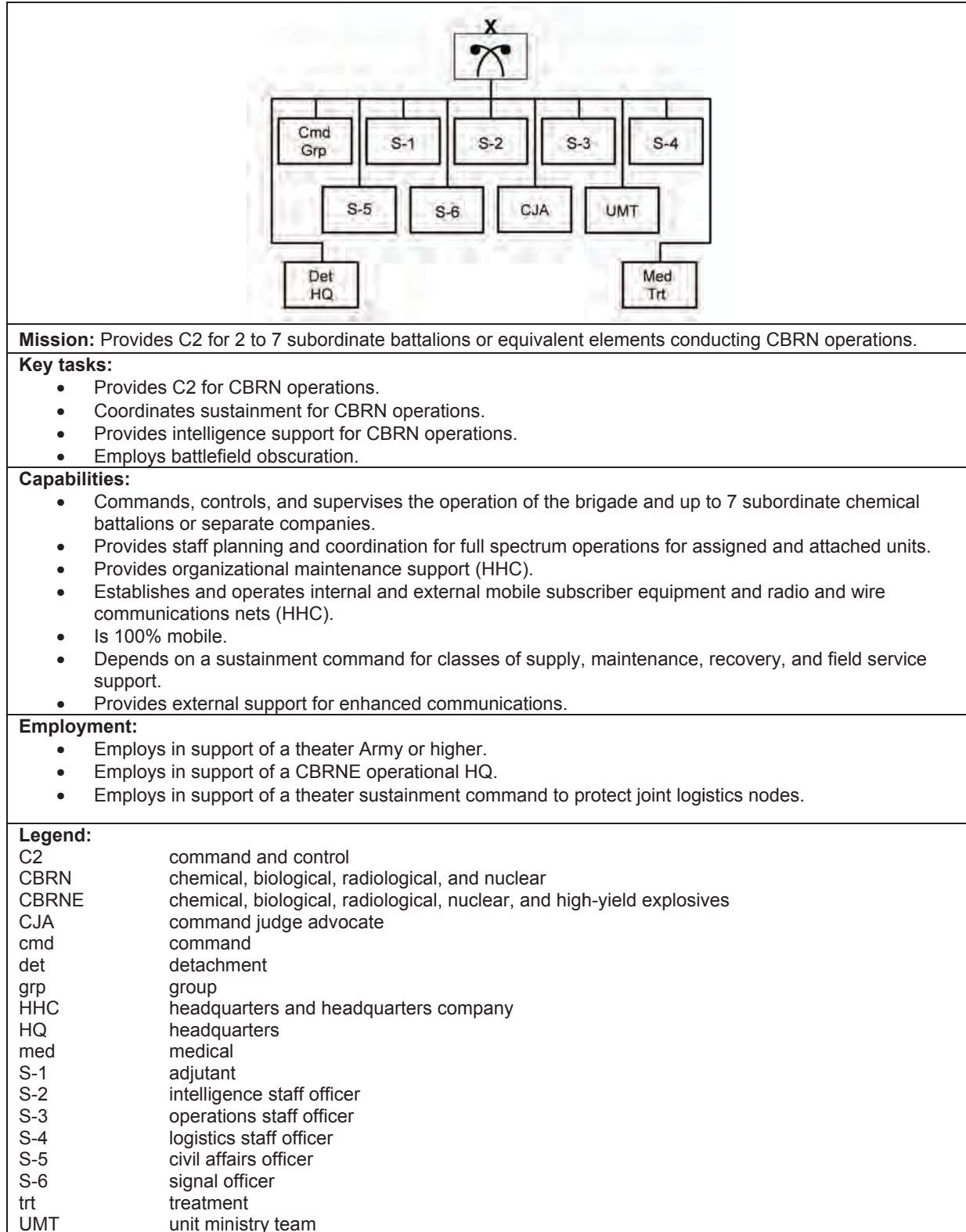
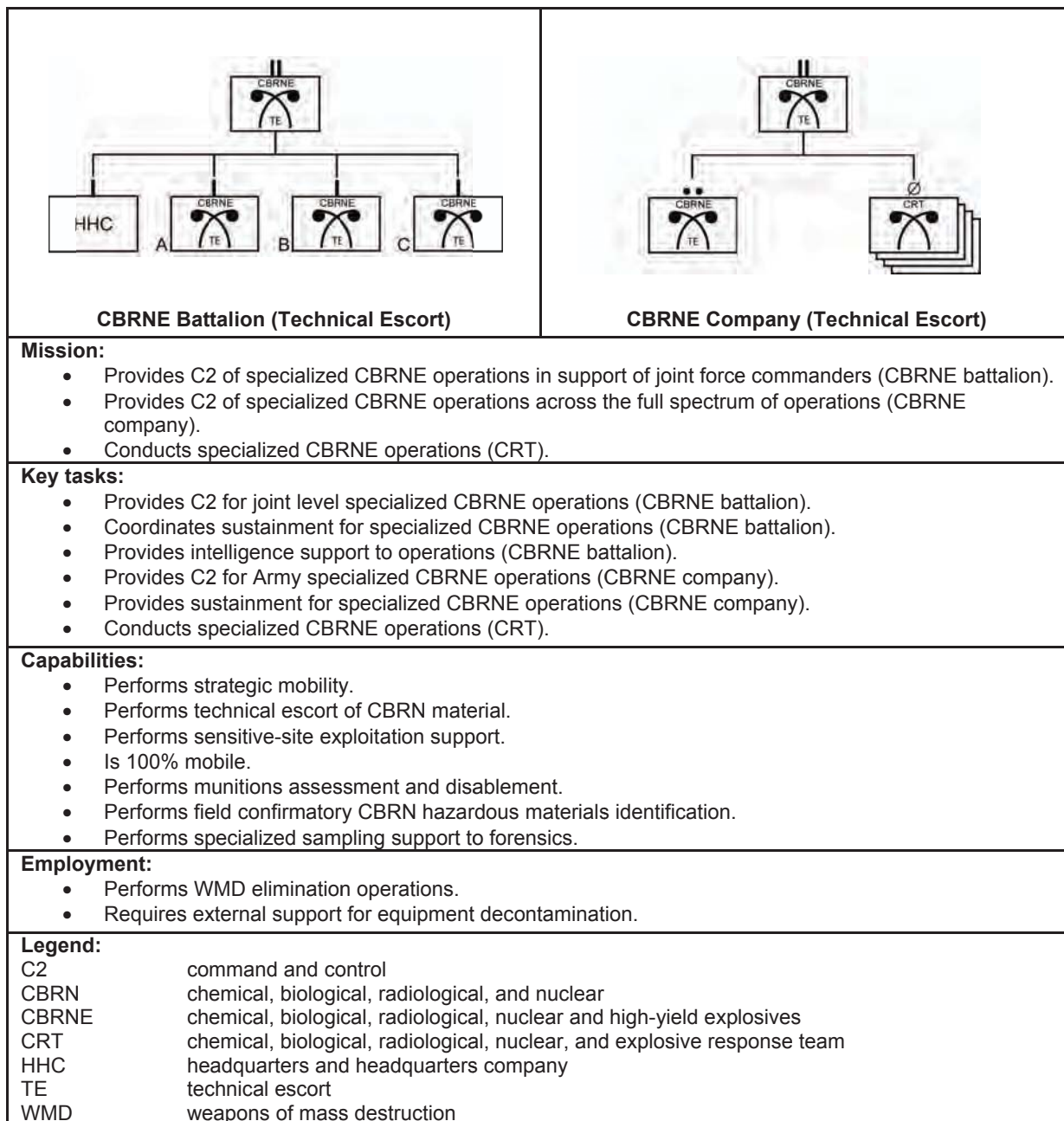

Figure I-20. CBRN brigade headquarters (TOE 03492F000)

## CHEMICAL, BIOLOGICAL, RADIOLOGICAL, NUCLEAR, AND HIGH-YIELD EXPLOSIVES UNITS

I-35. The USA Chemical Corps maintains specialized CBRN units for technical CBRN operations, to include the escort of CBRN material and explosive ordnance disposal (EOD) capabilities. Typically, these low-density, high-demand organizations have enhanced training and equipment for operations in unique environments. (See figure I-21 for more information on CBRNE units.) (See FM 3-11.20 for more information on technical escort and FMI 3-90.10 for more information on other CBRNE units.)



**Figure I-21. CBRNE battalion and company (technical escort) (TOE 03636G000 and TOE 03537GA00)**

## CHEMICAL, BIOLOGICAL, RADIOLOGICAL, AND NUCLEAR STAFFS

I-36. CBRN staffs, elements, and support personnel generally exist at all levels of command. CBRN staff sections exist at the Army Service Component Command, corps division, brigade, Armored Cavalry Regiment, and battalion levels and are organized as part of the commander’s special staff. These sections are typically not an integral part of a coordinating staff section. Company level commands generally have CBRN personnel assigned or designated as additional duties.

### COMPANY CHEMICAL, BIOLOGICAL, RADIOLOGICAL, AND NUCLEAR NONCOMMISSIONED OFFICER

I-37. Most Army company-size units are authorized a CBRN NCO or CBRN specialist or require a member of the unit to perform CBRN defense functions as an additional duty. The company level CBRN NCO serves as the commander’s primary technical expert for operations in CBRN environments. Primary roles and responsibilities include—

- Advise the commander on the conduct of full spectrum operations in CBRN environments.
- Advise the commander on CBRN readiness for the unit and associated assessments.
- Advise the commander on the integration of CBRN threats and hazards into unit level training and associated assessments.
- Maintain the unit CBRN room.
- Maintain appropriate and current publications associated with CBRN operations.
- Perform organizational level maintenance and supervise operator level maintenance for CBRN defense equipment.
- Coordinate unit supply activities associated with CBRN defense equipment.
- Maintain the unit level optical inserts program.
- Develop, in conjunction with the unit leadership, the unit level administrative, deployment, and tactical SOPs as appropriate.
- Manage unit reports related to CBRN operations (CBRNWRS).

### CORE CHEMICAL, BIOLOGICAL, RADIOLOGICAL, AND NUCLEAR STAFF FUNCTIONS

I-38. A CBRN staff section or element performs the same basic duties at most echelons of command. In addition to common staff responsibilities, CBRN staff-specific responsibilities fall into the four basic activities of the operations process: assessment (continuous), planning, preparation, and execution. (See table I-1 for the core functions of a CBRN section.)

**Table I-1. CBRN section core functions**

<p><b>Assessment:</b></p> <ul style="list-style-type: none"> <li>● Conducts CBRN threat assessment as an integral part of the staff IPB process.</li> <li>● Conducts an assessment of the OE, to include terrain, weather, and civil considerations.</li> <li>● Conducts CBRN vulnerability assessments as an integral part of the commander’s risk management process.</li> <li>● Conducts CBRN capabilities assessments of friendly assets.</li> </ul>
<p><b>Planning:</b></p> <ul style="list-style-type: none"> <li>● Provides technical advice and planning recommendations on CBRN ISR operations.</li> <li>● Provides technical advice and planning recommendations on CBRN obscuration operations.</li> <li>● Provides technical advice and planning recommendations on CBRN decontamination operations.</li> <li>● Provides technical advice and recommendations on MOPP level, troop safety criteria, OEG, and vulnerability mitigation measures.</li> <li>● Plans and recommends the use of flame field expedients to supplement unit defense and existing minefield sand barriers.</li> <li>● Plans and manages CBR survey and monitoring operations.</li> <li>● Participates in targeting meetings, serving as the CBRN SME.</li> <li>● Assesses weather and terrain data to determine if environmental factors favor enemy employment of WMD.</li> </ul>



**Table I-1. CBRN section core functions (continued)**

<b>Planning (continued):</b>	
<ul style="list-style-type: none"> <li>• Plans and initiates, in conjunction with the surgeon, procedures to verify and report enemy first use of CBRN agents.</li> <li>• Predicts fallout from the friendly employment of nuclear weapons and disseminate nuclear strike warning messages when required.</li> <li>• Estimates the effect of the unit radiation exposure state on mission assignments.</li> <li>• Recommends COAs to minimize friendly and civilian CBRN vulnerability.</li> <li>• Estimates the consumption rates of CBRN defense equipment and supplies.</li> <li>• Assesses and adjusts the staff estimate (continuously).</li> </ul>	
<b>Preparation:</b>	
<ul style="list-style-type: none"> <li>• Coordinates across the entire staff while assessing the impact of enemy CBRN-related attacks and hazards on current and future operations.</li> <li>• Coordinates CBRN reconnaissance employment in the reconnaissance and surveillance plan.</li> <li>• Coordinates obscuration and obscurant operations in support of the tactical plan.</li> <li>• Conducts obscuration target development.</li> <li>• Coordinates with the surgeon on HSS requirements for CBRN operations.</li> <li>• Maintains and reports the radiation exposure and total dose status in coordination with the surgeon.</li> <li>• Assesses the probability and impact of CBRN-related casualties.</li> <li>• Supervises and coordinates CBRN decontamination operations (except patient decontamination).</li> <li>• Coordinates with the G-4/S-4 on logistics as it relates to CDE and supplies, the maintenance of chemical equipment, and the transportation of chemical assets.</li> <li>• Assesses and adjusts the staff estimate (continuously).</li> </ul>	
<b>Execution:</b>	
<ul style="list-style-type: none"> <li>• Manages the CBRNWRS.</li> <li>• Prepares CBRN SITREPs.</li> <li>• Supervises the nuclear and chemical accident and incident response assistance program.</li> <li>• Oversees the construction of CBRN shelters.</li> <li>• Collates, evaluates, and distributes CBRN attack and contamination data.</li> <li>• Advises the commander on the possible effects of low-level hazards, to include TIM, in conjunction with the surgeon.</li> <li>• Advises the commander on the use of RCAs.</li> <li>• Advises the commander on WMD-E operations and the effects of destroying enemy WMD sites.</li> <li>• Assesses and adjusts the staff estimate (continuously).</li> </ul>	
<b>Legend:</b>	
CBR	chemical, biological, and radiological
CBRN	chemical, biological, radiological, and nuclear
CBRNWRS	chemical, biological, radiological, and nuclear warning and reporting system
CDE	chemical defense equipment
COA	course of action
G-4	Assistant Chief of Staff (Logistics)
HSS	health service support
IPB	intelligence preparation of the battlefield
ISR	intelligence, surveillance, and reconnaissance
MOPP	mission-oriented protective posture
OE	operational environment
OEG	operational exposure guide
RCA	riot control agent
S-4	supply officer
SITREP	situation report
SME	subject matter expert
TIM	toxic industrial material
WMD	weapons of mass destruction
WMD-E	weapons of mass destruction elimination

## **CHEMICAL, BIOLOGICAL, RADIOLOGICAL, AND NUCLEAR SPECIAL STAFFS**

I-39. CBRN special staffs exist at the battalion and brigade levels. These staff sections provide technical advice to the commander for the unit employment of capabilities for the conduct of CBRN operations, and they supervise the organizational readiness of the command for operations in CBRN environments.

### **BATTALION CHEMICAL, BIOLOGICAL, RADIOLOGICAL, AND NUCLEAR SPECIAL STAFF**

I-40. The battalion CBRN staff typically includes a CBRN officer (lieutenant) and CBRN NCO (staff sergeant); and in some organizations, may only include a CBRN NCO (staff sergeant or sergeant first class). Many battalion-size units also have a CBRN specialist assigned to assist in the employment of organic operational-level decontamination capabilities. This staff performs core CBRN staff functions, as applicable, with emphasis on the following key tasks:

- Advise the commander on all CBRN hazards, ranging from WMD to TIM.
- Implement CBRN protective measures.
- Provide CBRN warning and reporting.
- Prepare CBRN plans and orders.
- Plan operational-level decontamination missions.
- Train and mentor company level CBRN Soldiers.

### **BRIGADE CHEMICAL, BIOLOGICAL, RADIOLOGICAL, AND NUCLEAR SPECIAL STAFF**

I-41. The brigade CBRN staff typically includes a CBRN officer (captain or major) and CBRN NCO (sergeant first class); and in some organizations, may only include a senior CBRN NCO (sergeant first class). Brigade combat teams have organic CBRN reconnaissance platoons, so the CBRN staff recommends its employment and the employment of any additional CBRN assets that may be task-organized as a part of the combined arms team. Maneuver enhancement brigade CBRN staffs are more robust and complex than the brigade combat team or functional brigade staffs (see FM 3-90.31 for more information on MEBs). This staff performs core CBRN staff functions, as applicable, with emphasis on the following key tasks:

- Advise the commander on all CBRN hazards, ranging from WMD to TIM.
- Plan CBRN unit employment.
- Prepare and process CBRN warning and reporting information.
- Prepare contamination predictions.
- Plan thorough-level decontamination operations.
- Plan sensitive-site operations for CBRN-related activities.

## **CHEMICAL, BIOLOGICAL, RADIOLOGICAL, NUCLEAR, AND HIGH-YIELD EXPLOSIVES ELEMENTS**

I-42. Division and higher echelon specialty staffs include a more robust CBRN staff that is integrated with EOD personnel to form CBRNE elements.

### **DIVISION CHEMICAL, BIOLOGICAL, RADIOLOGICAL, NUCLEAR, AND HIGH-YIELD EXPLOSIVES ELEMENT**

I-43. The division CBRNE element (TOE 87000G900) operates as a part of the division protection cell located in the main command post. This element provides CBRNE personnel to support tactical command post functions as required. In addition, it provides support to the division plans cell as needed. The division CBRNE element performs most of the core CBRNE staff functions as required and as necessary to support division level operations or a joint task force if designated.

## **CORPS CHEMICAL, BIOLOGICAL, RADIOLOGICAL, NUCLEAR, HIGH-YIELD EXPLOSIVES ELEMENT**

I-44. The corps CBRNE element (TOE 52400G900) operates in a similar manner to that of the division, but operates as a part of the operational protection cell located in the main command post. This element provides CBRNE personnel to support alternate command post functions as required. In addition, it provides support to the corps plans cell as needed and will participate as a member of the targeting board in considering actions related to WMD sensitive sites. The corps CBRNE element performs most of the core CBRN staff functions as required for tactical-level operations, and as necessary to support Corps level operations or as a joint task force if designated.

## **ARMY SERVICE COMPONENT COMMAND CHEMICAL, BIOLOGICAL, RADIOLOGICAL, NUCLEAR, AND HIGH-YIELD EXPLOSIVES ELEMENT**

I-45. The Army Service Component Command (ASCC) CBRNE element (TOE 51600G000) supports a unified or combatant command and operates in a similar manner to that of the Corps as a part of the Operational Protection Cell located in the main command post. This element provides CBRNE personnel to support alternate command post functions as required. In addition, it provides support to the plans cell as needed, and will participate as a member of the targeting board in considering actions related to WMD sensitive sites. The ASCC will typically be augmented by the CBRNE coordination element, to support continuous operations consistent with information management associated with WMD and other CBRNE hazards in the operational area. The ASCC CBRNE element performs most of the core CBRNE staff functions as required with an operational-level focus and as necessary to support ASCC level operations or as a joint task force if designated.

## **SPECIALIZED TEAMS AND TASK FORCES**

I-46. The USA Chemical Corps maintains the predominance of the organization CBRN capabilities for the USA; and in some cases, for the Joint force. In addition, the USA maintains other organizational capabilities related to CBRN operations (operational commands, special operating forces, medical, EOD, civil support). This section highlights these additional capabilities and directs the reader to additional references related to their missions, tasks, capabilities, and employment considerations.

## **CHEMICAL, BIOLOGICAL, RADIOLOGICAL, NUCLEAR, AND HIGH-YIELD EXPLOSIVES OPERATIONAL HEADQUARTERS**

I-47. The CBRNE operational headquarters is designed, staffed, and trained to be the controlling headquarters to identify, target, plan, and coordinate service response to WMD threats in support of national combating WMD objectives. By design, this headquarters executes, tracks, and manages the response and provides C2 for Army and/or joint specialized CBRNE forces; executes WMD-elimination missions; and provides technical capabilities and CBRNE subject matter expertise to joint and Army commanders. Elements of this headquarters are designed to deploy and provide the core elements of a JTF headquarters in support of WMD-elimination or similar missions. The inclusion of a joint elimination coordination element that is provided by the U.S. Strategic Command is an essential element of a JTF headquarters. (See FMI 3-90.10 for more information.)

## **CHEMICAL, BIOLOGICAL, RADIOLOGICAL, AND NUCLEAR RECONNAISSANCE DETACHMENT**

I-48. The CRD plans, conducts, and provides CBRN reconnaissance and surveillance support for special operating forces in support of strategic, operational, and tactical objectives in all environments to support functional and geographic combatant commanders' intents and objectives. (See FM 3-05.132 for more information on CRDs and other CBRN-related, special-operations capabilities.)

## **MEDICAL**

I-49. The USA maintains several organizational capabilities to provide HSS in CBRN environments. Examples include casualty prevention, casualty care and management, patient movement, patient

decontamination, veterinary service support, food and water safety, medical laboratory support, combat and operational stress control, health service logistics support, civil support, and individual and collective protection. (See FM 4-02.7 for more information.)

### CIVIL SUPPORT

I-50. The USA in concert with other Services, may contribute to the DOD support to other lead federal agencies (Department of Homeland Security for domestic CBRN incidents). The National Guard Bureau maintains CBRN response forces that are under state government control according to Title 32 United States Code (USC), but may be federalized to respond to CBRNE incidents under Title 10 USC. The USA also provides forces to support the commander U.S. Northern Command Title 10 USC response plan which employs joint task force-combat support (JTF-CS) and potentially other JTFs for consequence management. These forces include—

- **Weapons of mass destruction–civil support teams (WMD-CST).** The WMD-CSTs consist of both ARNG and ANG personnel, and are designated to provide a specialized capability in response to a CBRN incident, primarily within Title 32 USC operations status within the United States and its territories, as established by Title 10 USC. Responding under the authority of the governor, they support civil authorities at a domestic CBRN incident site by identifying CBRN agents, assessing current and projected consequences, advising on response measures, and assisting with appropriate requests for additional support. The WMD-CSTs may also be federalized and deployed as a part of a federal response to an incident within or outside the WMD-CST assigned state. (See FM 3-11.22 for more information.)
- **Chemical, biological, radiological, nuclear, and high-yield explosives emergency response force package (CERFP).** The CERFP is a battalion-size task force tailored with existing ARNG units that are mobilized under Title 32 USC to provide a regional response in the event of a CBRNE incident. The CERFP follows WMD-CST capabilities during the immediate and reinforcing response phases of the response spectrum. The CERFP deploys to CBRNE incident sites to provide civil support to incident commanders by conducting consequence management operations to save lives and prevent human suffering. The CERFP units maintain additional specialized equipment and receive specialized training to perform safe operations in a CBRN environment. (See *Multiservice Tactics, Techniques, and Procedures for Chemical, Biological, Radiological, and Nuclear Consequence Management Operations* for more information.)
- **Chemical, biological, radiological, nuclear, and high-yield explosives consequence management response force (CCMRF).** The CCMRF mission under the JTF-CS or other designated JTF includes brigade-size combined arms task forces tailored as a reinforcing effort in response to CBRNE incidents, and operates under Title 10 USC authority and in support of the commander U.S. Northern Command. A CCMRF task force constitutes most of the JTF-CS task force response requirements, and provides force-tailored capabilities (casualty decontamination, security operations, medical triage and treatment, aviation, logistics, transportation). (See *Multiservice Tactics, Techniques, and Procedures for Chemical, Biological, Radiological, and Nuclear Consequence Management Operations* for more information.)

### CHEMICAL, BIOLOGICAL, RADIOLOGICAL, AND NUCLEAR COORDINATION ELEMENT

I-51. The CBRN-CE (TOE 03579LA00) provides staff augmentation to the ASCC for theater Army level CBRN staff planning, operations, and logistics support. The CBRN coordination element is a five-person cell, consisting of CBRN personnel who are led by a CBRN officer (typically a captain). (See figure I-22 for CBRN-CE.)

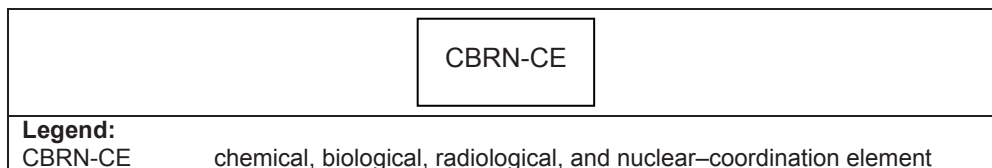

Figure I-22. CBRN-CE

## Appendix J

# U.S. Air Force Chemical, Biological, Radiological, and Nuclear Capabilities and Employment

This appendix provides an overview of the capabilities that USAF CBRN units and staffs provide to commanders. USAF CBRN defense operations provide a multitiered capability to combat WMD. Through complementary structures, these USAF capabilities ensure that the USAF will prevail in conflicts when an adversary possesses or uses CBRN weapons or devices. USAF capabilities to counter the CBRN threat are described within five interlinked counter-CBRN pillars: proliferation prevention, counterforce, active defense, passive defense, and consequence. These pillars, specific to the USAF mission, complement the broader pillars of nonproliferation, counterproliferation, and consequence identified in the *National Strategy to Combat Weapons of Mass Destruction* and the eight mission areas described in the *National Military Strategy to Combat Weapons of Mass Destruction*. Specific to this document are the USAF pillars of passive defense and consequence, which provide the framework for describing USAF CBRN defense capabilities.

## CHEMICAL, BIOLOGICAL, RADIOLOGICAL, AND NUCLEAR DEFENSE CAPABILITIES

J-1. The USAF emergency management program provides the capabilities to shape the OE, sense threats, shield resources from the deleterious effects of contamination, and sustain force survivability and mission continuation—in a CBRN environment—in support of passive defense and consequence. Warrior Airmen with CBRN-unique equipment and assigned to specific UTCs achieve goals within this structure by executing incident-specific, installation-wide, and theater-wide TTP in support of CCDRs.

J-2. These UTCs provide scalable, tailorable, and flexible options for commanders at all echelons through the five phases of emergency management: prevent, prepare, respond, recover, and mitigate. The UTC capability descriptions described below are typical, but not all-inclusive. USAF civil engineer squadrons and civil engineer groups at installation level are staffed by expert CBRN personnel in the Air Force specialty 3E9X1, *USAF Emergency Management*. Therefore, the readiness and emergency management flight in civil engineer squadrons and/or civil engineer groups manages and executes “W-Series” UTC capabilities. At major command and Air Staff levels, CBRN defense capabilities reside primarily on the installations and mission support (A7) staffs. The UTCs are as follows:

- **Personnel UTC 4F9WA.** This UTC consists of one consequence sergeant/E9 that provides strategic emergency management and counter-CBRN theater management to the JTF commander and the air operations center.
- **Personnel UTC 4F9WB.** This UTC consists of one senior master sergeant/E8 that provides operational emergency management and counter-CBRN theater management to the JTF commander and the air operations center.
- **Personnel UTC 4F9WC.** This UTC consists of one master sergeant/E7 that provides an emergency management and counter-CBRN installation manager to the installation control center, EOC, or readiness and emergency management flight.
- **Personnel UTC 4F9WD.** This UTC consists of one technical sergeant/E6 and one staff sergeant/E5 that provide core operational and tactical leadership for counter-CBRN response for a single, fixed installation in the tactical AO.



- **Personnel UTC 4F9WE.** This UTC consists of two junior NCOs or Airmen (E3–E5) that provide a core tactical team for CBRN incident response, ranging from sensitive-site exploitation to large-area reconnaissance, following a CBRN theater ballistic missile attack. This UTC provides the bulk of USAF CBRN defense forces.
- **Equipment UTC 4F9WL.** This UTC provides equipment for active CBRN response capabilities to conduct area, site, and facility survey; CBRN and TIM downwind hazard analysis; contaminated-area cordon definition, reduction, and expansion; identification of unknown substances and preliminary vapor, aerosol, solid, and liquid detection; and hazard plume modeling, investigation, and contamination extent.
- **Equipment UTC 4F9WN.** This UTC provides CBRN detection equipment for warning, reporting, and notification capabilities to forces supporting major contingency operations or asymmetrical threat responses.
- **Equipment UTC 4F9WP.** This UTC provides additional CBRN equipment to support UTC 4F9WN during major contingency operations or equipment/supplies necessary for CBRN detection, warning, reporting, and notification capabilities to bases located in medium- and low-threat areas.
- **Equipment UTC 4F9WS.** This UTC provides initial equipment for CBRN personnel decontamination capability for an installation with up to 3,300 personnel.
- **Equipment UTC 4F9WM.** This UTC provides in-garrison CBRN equipment to support force survivability and critical mission continuation response capabilities. It provides the ability to conduct response staging area assessment, downwind hazard analysis, initial cordon definition, cordon reduction/expansion, ground survey assessment, site/facility assessment/investigation, and unknown substance response. The UTC also provides preliminary vapor/aerosol and solid/liquid detection, hazard modeling with COP inputs, and hazard investigation and defines the extent of contamination for the incident commander, EOC director, and installation control center in support of mission requirements.

## INSTALLATION LEVEL MEDICAL AND PREVENTIVE MEDICINE SUPPORT CAPABILITIES

J-3. The “F-Series” UTC health risk assessment capabilities support the emergency management program; they are managed/executed by the USAF bioenvironmental function within medical squadrons and groups at installation level and on strike group staffs at headquarters level. USAF bioenvironmental specialists serve in Air Force specialty 43EX (officer) and 4B0X1 (enlisted), USAF bioenvironmental. The UTCs are as follows:

- **UTC FFPM1/2/3 Preventive Aerospace Medicine Team.** This UTC conducts public health, occupational, environmental, disease assessment, and surveillance, intervention, and abatement activities. It performs health risk assessments to support/enable mission effectiveness.
- **UTC FFGLB Wartime Medical Decontamination Team.** This UTC provides support personnel to remove or neutralize CBRN agents on wartime casualties prior to admission to medical treatment facility. It provides life-sustaining intervention before, during, and after decontamination.
- **UTC FFGL1 Medical Nuclear, Biological, and Chemical Team.** This UTC provides increased wing survivability through force health protection in a CBRN threat environment. It conducts CBRN surveillance; advises on health effects, threat impact, protective actions posture, and recovery activities; and performs CBRN health risk assessments.
- **UTC FFBAT Biological Augmentation Team.** This UTC provides advanced diagnostic preliminary identification for biological agents at deployed locations.
- **UTC FFHA2 Infectious Disease Module.** This UTC provides specialized infectious disease support personnel to diagnose, treat, and control the spread of natural or biological warfare-related infectious diseases.
- **UTC FFGRL Medical Global Reach Laydown Team.** This UTC provides preventive medicine and limited medical care for tanker airlift control elements. It performs health risk assessments to support/enable mission effectiveness.

## THEATER LEVEL MEDICAL AND PREVENTIVE MEDICINE SUPPORT CAPABILITIES

J-4. The following are theater level medical and preventive-medicine support capabilities:

- **UTC FFHA1 Medical Theater Epidemiology Team.** This UTC performs theater-wide health risk assessments and disease surveillance, analysis, consultation, and reporting using epidemiological, environmental/occupational, and entomological experts.
- **UTC FFRN1/2/3/4/5/6/7 Air Force Radiological Assessment Team.** This UTC consists of seven personnel teams and three equipment augmentation packages. It provides rapid, global response to radiation and nuclear accidents and incidents. The UTC also supports planning, surveillance, analysis, and assessment to mitigate radiation health or operational risks resulting from radiation/nuclear events.

## CHEMICAL, BIOLOGICAL, RADIOLOGICAL, AND NUCLEAR DEFENSE SUPPORT ASSETS

J-5. The following are CBRN defense support assets:

- **Air Force Civil Engineer Support Agency.** The emergency management division plans, trains, equips, and conducts USAF emergency management programs that include CBRNE, WMD, and hazardous materials incidents; natural disasters; and major accidents. The emergency management division also coordinates homeland security issues and is the lead U.S. representative for international CBRN defense standardization. (For more information, visit < <http://www.afcesa.af.mil>>.)
- **Air Force Medical Service.** The Air Force Medical Service has robust home station medical-response capabilities in support of the installation mission during a CBRN event. Capabilities include equipment and personnel for CBRN hazard surveillance/health risk assessment, patient decontamination, casualty prevention/management, and quick identification of endemic disease/biological agents.
- **Air Force Technical Applications Center.** The Air Force Technical Applications Center is the sole DOD agency operating and maintaining a global network of nuclear-event integrated detection networks. This global network is the U.S. Atomic Energy Detection System. Once the U.S. Atomic Energy Detection System senses a disturbing event underground, underwater, in space, or in the atmosphere, the Air Force Technical Applications Center experts analyze the event for nuclear identification and report findings to the national command authorities through Headquarters, USAF.
- **Air Force Nuclear Weapons and Counterproliferation Agency.** The Air Force Nuclear Weapons and Counterproliferation Agency provides the warfighter with CBRN science and technology to ensure effective nuclear stockpile stewardship and operational and technical options for combating WMD threats. The Air Force Nuclear Weapons and Counterproliferation Agency supports air staff customers and stakeholder agencies in the national capital region on matters concerning stockpiled systems and combating WMD technologies.
- **Air Force Weather Agency.** The Air Force Weather Agency designates specific units to notify specific installations of severe weather patterns affecting installations. The Air Force Weather Agency ensures that—
  - Installation weather squadrons can provide weather data for CBRN material dispersion models, including TIM assessments.
  - Operational weather squadrons provide meteorological information necessary to produce chemical downwind messages and effective downwind messages for radiological fallout.
- **Air Force Research Laboratory.** The Air Force Research Laboratory, Human Effectiveness Directorate, Biosciences and Protection Division, Counterproliferation Branch, CB Defense Office, acts as a USAF science and technology advisor to the USAF counter-CBRN education, training, and exercise working group.
- **Air Force Institute for Operational Health.** The Air Force Institute for Operational Health promotes global health and protects USAF warriors and communities by enhancing



readiness/mission effectiveness. The Air Force Institute for Operational Health develops/implements creative solutions to operational health problems through health/environmental surveillance, risk analysis, process reengineering, consultation, and technological innovations. It also provides CBRN consultation/health risk assessment, lab services, and comprehensive disease surveillance.

## CHEMICAL, BIOLOGICAL, RADIOLOGICAL, AND NUCLEAR REPORTING

J-6. To prepare for, respond to, recover from and, when possible, mitigate the effects of contamination on USAF operations, detailed notification procedures are established. These procedures ensure that the national command authorities of the United States and/or HN send and receive timely and accurate decisionmaking CBRN weapons information.

J-7. At the installation level, the highest level of command resides in the installation control center, from which air operations are planned and executed by the commander's senior staff. (See figure J-1 for the USAF national CBRN reporting chain of command.) CBRNE support operations (personnel survivability and mission continuation, response, recovery, mitigation) are controlled from the installation EOC. CBRNE C2 tasks reside within the installation EOC and, more specifically, the majority of those tasks are executed through the CBRNE control center located physically within or virtually connected to the EOC.

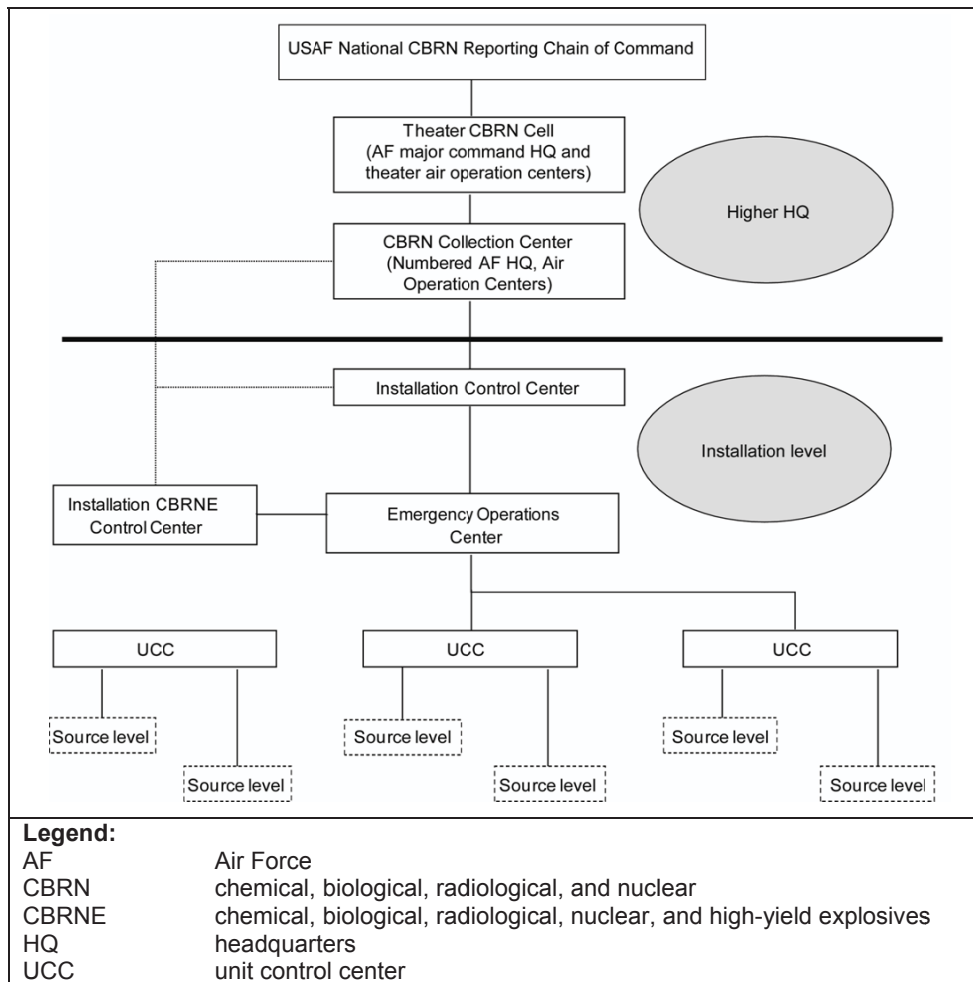

Figure J-1. USAF national CBRN reporting chain of command

J-8. The installation CBRNE control center, also known as the CBRN cell, should not be confused with the NATO definition of CBRN control center, which is the highest level of CBRN C2 during NATO-led operations. Additionally, the installation CBRNE control center is staffed with CBRN specialist personnel as a primary duty. Their tasks include CBRN warning, reporting, plotting, evaluation, analysis, communications, notification, and other associated execution tasks.

J-9. Each CBRNE C2 center at every level of command is responsible for reporting CBRN events to the next higher level of command. The following defines the scope of the various levels of CBRNE C2 within the USAF.

### **SOURCE LEVEL**

J-10. This is the first level in the CBRN defense system and is best defined as being the individual warrior Airman. This includes those Airmen manning observation posts and sites, reconnaissance teams, detection teams, and postattack reconnaissance teams. These source level Airmen may or may not be CBRN specialist personnel, but have been fully trained to report indications of a CBRNE incident to their respective functional C2 formation in their unit control center. The unit control center then reports collective findings directly to the installation EOC and/or CBRNE control center. Airmen at the source level accomplish the following tasks:

- Report the initial enemy use of CBRN weapons, devices, or agents by the most expeditious means available.
- Immediately report further CBRN attacks and subsequent data to their respective unit control center.
- Receive notification and timely warning of predicted hazard areas to enable forces to increase their CBRN state of readiness; to conduct monitoring; and to prepare for reconnaissance, survey, and decontamination.
- Report monitoring and reconnaissance survey results to the respective unit control center.
- Submit detailed information on CBRN incidents within their capability.

### **INSTALLATION CHEMICAL, BIOLOGICAL, RADIOLOGICAL, AND NUCLEAR CONTROL CENTER**

J-11. These C2 centers function at air division headquarters, sector operation centers, or main operating air bases for task force commanders. CBRNE control centers (or NATO Subcollection Centers) receive reports from many source level Airmen and have personnel to execute the following tasks:

- Advise installation leadership on CBRNE defense.
- Report the initial enemy use of CBRN weapons, devices, or agents by the most expeditious means available.
- Clarify, consolidate, and evaluate CBRN attack data reported from the source level or other CBRN centers or agencies.
- Compute detailed fallout predictions and detailed chemical downwind hazard areas (where possible) based on processed CBRN attack data, and send the appropriate warnings to units likely to be affected.
- Direct survey efforts within its zone of observation.
- Analyze survey and monitoring results, and identify the actual contaminated areas to units likely to be affected.
- Request and provide detailed information on CBRNE incidents.
- Exchange CBRN information with appropriate national military and civilian authorities as arranged by directives and SOPs.

### **CHEMICAL, BIOLOGICAL, RADIOLOGICAL, AND NUCLEAR COLLECTION CENTER**

J-12. These C2 centers function at numbered USAF headquarters, air operation centers and, occasionally, at main operating air bases to support task force commanders. CBRN collection centers generally receive

reports from multiple CBRNE control centers (or NATO subcollection centers) and have personnel to execute the following tasks:

- Report the initial enemy use of CBRN weapons by the most expeditious means available according to directives and SOPs.
- Clarify, correlate, consolidate, and evaluate CBRN attack data reported from other CBRN centers or agencies.
- Promptly transmit CBRN warnings to adjacent headquarters or agencies when predicted hazard areas extend beyond their own area of observation.
- Exchange CBRN information with appropriate national military and civilian authorities as arranged by directives and SOPs.
- Organize and coordinate the CBRN warning and reporting system within its area of observation by contributing to the war plans (contingency plans), and issue a comprehensive directive and/or SOP.
- Submit reports to higher headquarters and adjacent agencies as required.

### **THEATER CHEMICAL, BIOLOGICAL, RADIOLOGICAL, AND NUCLEAR CELL**

J-13. These C2 centers function at USAF major command headquarters and, occasionally, at theater air operations centers to support JTF commanders. Theater CBRN cells generally receive reports from multiple CBRNE collection centers and have personnel to execute the following tasks:

- Report the initial enemy use of CBRN weapons by the most expeditious means available according to directives and SOPs.
- Clarify, correlate, consolidate, and evaluate CBRN attack data reported from other CBRN centers or agencies.
- Promptly transmit CBRN warnings to adjacent headquarters or agencies when predicted hazard areas extend beyond their own area of observation.
- Exchange CBRN information with appropriate national military and civilian authorities as arranged by directives and SOPs.
- Organize and coordinate the CBRN warning and reporting system within its area of observation by contributing to the war plans (contingency plans), and issue a comprehensive directive and/or SOP.
- Submit reports to higher headquarters and adjacent agencies as required.

J-14. Additional CBRN capabilities and assets that are directly tied to the principles of CBRN defense (contamination avoidance, CBRN protection, and decontamination) are found in various CBRN-related, multi-Service doctrinal publications as indicated in the references section.

## Appendix K

# U.S. Marine Corps Chemical, Biological, Radiological, and Nuclear Capabilities and Employment

This appendix provides an overview of the USMC organizational capabilities that conduct CBRN operations in support of Marine commanders and doctrinal employment at the tactical level. It provides the organizational structure, doctrinal mission and corresponding mission sets, tactical employment, organizational capabilities, organizational dependencies, and basis of allocation for CBRN staffs and units from the battalion to Marine expeditionary force level in support of the Marine air-ground task force (MAGTF).

## CHEMICAL, BIOLOGICAL, RADIOLOGICAL, AND NUCLEAR OPERATIONAL CONCEPT

K-1. The USMC operating forces are unique. The USMC, as part of national maritime forces, provide expeditionary forces to project combat power ashore in support of naval campaigns or in conjunction with USA and USAF units. The USMC is designed to provide sea-based, self-sustained power projection and forcible entry ashore and nontraditional missions (noncombatant evacuation operations, security operations, tactical recovery of aircraft personnel, humanitarian assistance/disaster relief). These forces provide a swift and effective means of responding to fast-breaking crises and can remain on station for indefinite periods of time, ready to intervene or take action if needed.

K-2. MAGTF CBRN operations and capabilities currently fall into one of four joint CBRN functional concept categories: CBRN shape, CBRN sense, CBRN shield, and CBRN sustain. The USMC focuses these concepts to allow commanders to make decisions quickly and heavily relies on proper staff education and coordination to operate in a CBRN environment. MAGTF operations in a CBRN environment will focus on operational risk management-guided decisions that allow the MAGTF commander to minimize the operational impact of CBRN effects. This concept provides the foundation for emerging support to the MAGTF commander regarding the eight military mission areas outlined in the *National Military Strategy for Combating Weapons of Mass Destruction*. The future operational concept is to conduct CBRN operations in support of combating WMD and the protection warfighting function by employing task-organized CBRN forces and specialized CBRN elements or teams, task-organized to an appropriate CBRN or other C2 headquarters.

K-3. The MAGTF CBRN organization maintains two distinct categories to support the MAGTF with CBRN capabilities—CBRN units and CBRN staffs. (See figure K-1, page K-2, for the categories and representative organizations within them.)

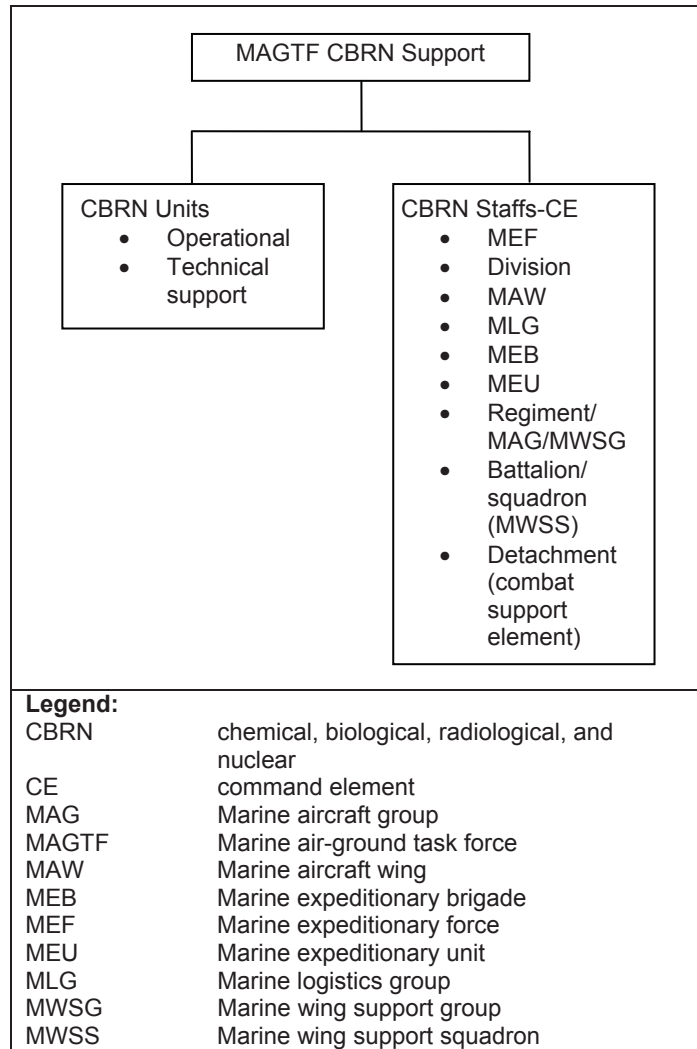

**Figure K-1. MAGTF CBRN organization**

**CHEMICAL, BIOLOGICAL, RADIOLOGICAL, AND NUCLEAR UNITS**

K-4. MAGTF CBRN support units fall into two broad categories: operational and technical. Operational CBRN units include CBRN platoons—at the MSC level (division), Marine aircraft wing, and Marine logistics group—and teams within the MSC that support the Marine expeditionary. Technical CBRN units include technical escort support coupled with the MAGTF consequence set.

**CHEMICAL, BIOLOGICAL, RADIOLOGICAL, AND NUCLEAR STAFFS**

K-5. The MAGTF CBRN staffs support the USMC modular force design by incorporating a combination of CBRN officers and CBRN specialists at the detachment (combat service support detachment), battalion/squadron, regiment/Marine aircraft group/Marine wing support group, Marine expeditionary unit, Marine expeditionary brigade, and division, Marine logistics group, Marine aircraft wing, and Marine expeditionary force echelons at the command element and CBRN-trained augments at the company/squadron level.

## CHEMICAL, BIOLOGICAL, RADIOLOGICAL, AND NUCLEAR UNITS

K-6. CBRN operational units include chemical and biological incident response force (CBIRF), CBRN platoons (division, Marine aircraft wing, and Marine logistics group), and CBRN teams. They represent the largest number of CBRN organizational capability in the USMC. Besides CBIRF, the platoon is the basic general-purpose unit of employment. CBRN platoons are task-organized to support the MAGTF commander (CBRN reconnaissance or decontamination platoons). Each Marine expeditionary force possesses organic CBRN reconnaissance capability. (See figure K-2 for CBRN operational units.)

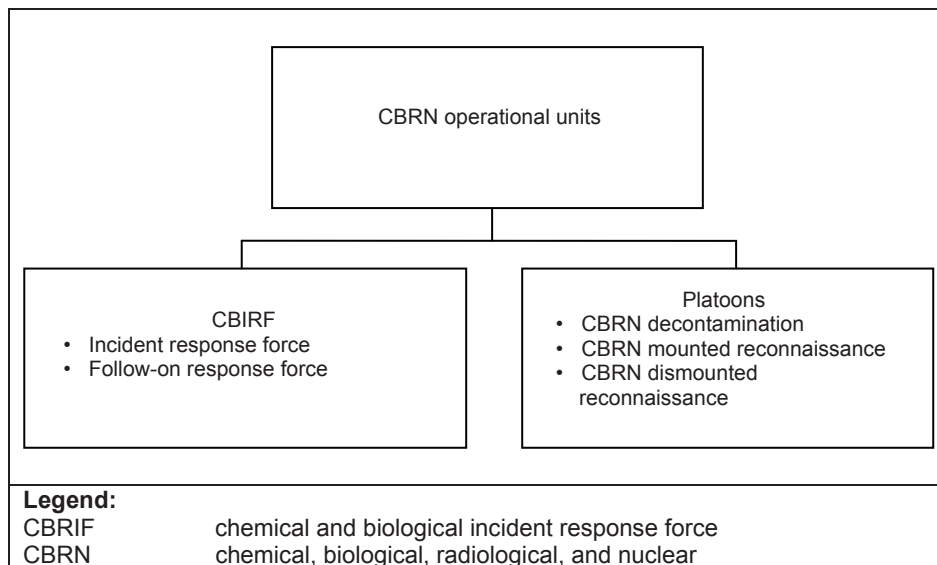

Figure K-2. MAGTF CBRN operational units

## CHEMICAL AND BIOLOGICAL INCIDENT RESPONSE FORCE

K-7. CBIRF was created in 1996 to fill a need that was lacking in the national ability to respond to a terrorist attack or WMD incident. Prior to unit activation, the federal government did not have a coherent response capability for a CBRNE event that could holistically provide detection, identification, extraction, mass decontamination, and medical triage.

K-8. CBIRF is a battalion-size unit of nearly 500 Marines and Seamen comprised of more than two dozen MOSs and capable of performing a broad range of consequence tasks. Due to the nature of the WMD threat, CBIRF has to be prepared 24 hours a day, 365 days a year to respond to a sudden attack or incident. CBIRF maintains a standing operational task-organized force, known as the initial response force (IRF). The IRF is a task-organized, trained, standing reaction force comprised of approximately 131 CBIRF personnel. It is manned and equipped to provide the full range of incident response capabilities for contaminated-environment operations, to include C2, agent detection and identification, casualty extraction, extrication, emergency medical care and stabilization, limited EOD capability, response force and casualty decontamination, and internal organic FP. This force is logistically self-sustaining and prepared to integrate into the civilian Incident/Unified Command System or as part of a DOD JTF. Upon deployment of the first incident response force, CBIRF will immediately stand up its second incident response force. Within 6 hours, this force will be ready to act as a follow-on-force for the first incident response force or as an independent response force for another incident.

K-9. The II Marine Expeditionary Force is the operational Marine expeditionary force under Marine Forces Command. It retains operational control of CBIRF with requests for forces going through Marine forces command and to II Marine Expeditionary Force for commitment of CBIRF personnel. Requests for forces flow to the President of the United States or Secretary of Defense through the Joint Forces Command (JFCOM). Approved requests for CBIRF participation are assigned by JFCOM to Marine forces

command and II Marine Expeditionary Force for action and to the CBIRF commander for execution. Additionally, CBIRF is often tasked to pre-position forces in support of specific national special security events designated by the U.S. Secret Service. Although it is generally believed that CBIRF directly supports the JTF national capital region, CBIRF may be (and has been) tasked to support missions within CONUS outside of the national capital region and OCONUS. (See table K-1 for CBIRF tactical data.)

**Table K-1. CBIRF tactical data**

<b>Mission:</b> Support operational USMC units worldwide and civil authorities at a domestic chemical or biological incident site by identifying CB agents/substances, assessing current and projected consequences, advising on response measures, and assisting with appropriate requests for state support.	
<b>Mission sets:</b>	
<ul style="list-style-type: none"> <li>• Identifies CBRNE hazards.</li> <li>• Assesses CBRNE hazards.</li> <li>• Assists MASCAL decontamination efforts.</li> <li>• Provides technical rescue.</li> <li>• Advises civil responders.</li> <li>• Assists emergency responders.</li> </ul>	
<b>Employment:</b> As required by the USMC.	
<b>Capabilities:</b>	
<ul style="list-style-type: none"> <li>• Provides and maintains internal C2.</li> <li>• Establishes an operations center to synchronize operations and support interagency forces.</li> <li>• Furnishes C2 forces.</li> <li>• Provides situational understanding to military command channels.</li> <li>• Conducts unit level administration and logistics.</li> <li>• Communicates internally and externally, maintaining tactical, operational, and strategic secure and nonsecure real-time voice, data, and video access.</li> <li>• Provides highly technical analytical collection and presumptive identification.</li> <li>• Conducts unit level decontamination.</li> </ul>	
<b>Organizational dependencies:</b> For operations longer than 12 to 24 hours, CBIRF depends on external agencies for sustainment.	
<b>Allocation rules:</b> Approved requests for CBIRF participation are assigned by JFCOM to MARFORCOM and II MEF for action and to the CBIRF commander for execution.	
<b>Legend:</b>	
C2	command and control
CB	chemical and biological
CBIRF	chemical and biological incident response force
CBRNE	chemical, biological, radiological, nuclear, and high-yield explosives
JFCOM	joint forces commander
MARFORCOM	Marine forces command
MASCAL	mass casualty
MEF	Marine expeditionary force
USMC	U.S. Marine Corps

**MISSION**

K-10. The CBIRF mission statement reads, “When directed, forward deploy and/or respond to a credible threat of a CBRNE incident to assist local, state, or federal agencies and unified combat commanders in the conduct of consequence operations. CBIRF accomplishes this mission by providing capabilities for agent detection and identification; casualty search, rescue, and personnel decontamination; and emergency medical care and stabilization of contaminated personnel.”

K-11. CBIRF assists local, state, or federal agencies and designated CCDRs in the conduct of consequence operations. It provides key capabilities, including agent detection and identification; casualty search, rescue, and personnel decontamination; emergency medical care; and the stabilization of contaminated personnel. CBIRF ability to assist civil authorities is enhanced by its adherence to the applicable federal



regulations regarding hazardous materials response and its inventory of National Institute for Occupational Safety and Health (NIOSH)-certified response equipment. CBIRF is structured for domestic and foreign consequence operations and remains on a one-hour alert to respond to contingency. Operationally, CBIRF is capable of deploying up to 330 personnel, task-organized to provide detection and identification of 120,000 toxic industrial chemicals; known chemical-warfare agents; eight biological agents; and alpha, beta, gamma, neutron, and X-ray emissions.

K-12. The CBIRF, on its own or in conjunction with other DOD assets (National Guard [NG] WMD civil support teams, CBRNE-enhanced response force package, USCG strike teams) will detect and identify CBRN agents/substances, assess the potential effects of the WMD incident, advise the local authorities on managing the effects of the attack, and assist with appropriate requests for additional support to minimize the impact on the civilian population.

K-13. The CBIRF has the ability to locate and extract victims from a contaminated environment, perform medical triage and treatment in contaminated environments, and perform mass patient/casualty decontamination to support civil first responders or military authorities. In a general tiered-response scenario, WMD civil support team, NG CBRNE-enhanced response force package, and CBIRF capabilities would be complementary and completely interoperable with civilian responders according to the National Incident Management System using the incident command system. Identified as a “dual purpose” unit because of its worldwide deployment status, CBIRF is also capable of deploying in support of a foreign consequence incident, enabling it to augment a joint force commander, Department of State officials, or other U.S. or non-U.S. agencies as directed. To accomplish these tasks, CBIRF personnel receive specialized training in hazardous materials operations, personal protective equipment, and additional training in the technical aspects of performing their regular and specialized duties in hazardous environments.

K-14. Since its establishment in April 1996, CBIRF has operationally deployed in support of multiple national special security events, including the 1996 Atlanta Olympics, presidential inauguration ceremonies in 1996 and 2000, presidential State of the Union addresses, the 1999 papal visit, the 1999 NATO summit, and the Y2K (year 2000) celebration. During Operation Noble Eagle, CBIRF supported response operations at the U.S. Capitol by collecting more than 600 biological samples and removing and screening 12 tons of congressional mail and office equipment. CBIRF and its mobile training teams have also deployed overseas in support of multiple exercises in Jordan, Bahrain, Iceland, Qatar, Kuwait, Italy, France, the Philippines, and Japan.

K-15. CBIRF is a USN-USMC team that is tasked with executing a challenging mission to meet an emerging threat. It is most effective when forward-deployed in support of a CCDR or designated lead federal agency.

## **CAPABILITIES**

K-16. The CBIRF includes a complete WMD consequence response package and remains the only single-source, DOD unit that is capable of providing C2 and supporting elements required for a CBRN consequence incident—foreign or domestic. The following are the capabilities of the CBIRF:

- A battalion-size unit of nearly 500 Marines and Seamen comprised of more than 24 MOSs.
- An IRF of approximately 131 personnel maintains 24-hour readiness.
- A second incident response force that can deploy and operate independently or augment the first incident response force for sustained operations.

K-17. Each incident response force provides the following capabilities:

- **Detection and identification.** Detection and identification includes known chemical-warfare agents, many biological warfare agents, and more than 120,000 toxic industrial chemicals.
- **Casualty search and extraction.** Casualty search and extraction includes more than 150 emergency medical technicians who are able to operate in Levels A through C personal protective equipment. They perform technical casualty search and rescue for 12 nonambulatory cases per hour.

- **Technical rescue.** Technical rescue includes more than 35 Federal Emergency Management Agency urban search and rescue qualified Marines.
- **Personal decontamination.** Personal decontamination includes self-contained decontamination for ambulatory and nonambulatory casualties. Personnel decontaminate 150 nonambulatory and 450 ambulatory casualties per hour.
- **Medical care and stabilization.** Medical care and stabilization includes 50 emergency room doctors, nurses, physician assistants, and corpsmen, able to operate in full personal protective equipment. They provide medical triage and antidotes for 1,500 nerve-agent casualties and airway management for 28 respiratory casualties per hour.
- **EOD.** Includes 10 EOD Marines, capable of operating in full personal protective equipment. conduct manned and unmanned EOD.
- **C4I.** C4I includes establishing C4I connectivity with secure voice and satellite communications and conducting open-purchase logistics.

## CHEMICAL, BIOLOGICAL, RADIOLOGICAL, AND NUCLEAR RECONNAISSANCE UNITS

K-18. MAGTF CBRN reconnaissance support is divided into dismounted mobile platforms, by technically trained personnel. (See table K-2 for more information on the reconnaissance platoon [NBC reconnaissance system].)

**Table K-2. CBRN reconnaissance platoon (NBC reconnaissance system)**

<p><b>Mission:</b> Provide CBRN reconnaissance, surveillance, and limited CM support to military forces or civil authorities.</p>
<p><b>Mission sets:</b></p> <ul style="list-style-type: none"> <li>● Performs dismounted CBRN reconnaissance.</li> <li>● Performs CBRN surveillance.</li> <li>● Performs CBRN site assessment.</li> </ul>
<p><b>Employment:</b></p> <ul style="list-style-type: none"> <li>● Is the ground reconnaissance element.</li> <li>● Determines what platoon employment is most efficient in maximizing responsive monitoring and area survey.</li> <li>● Conducts surveys, sampling, and marking.</li> </ul>
<p><b>Capabilities:</b></p> <ul style="list-style-type: none"> <li>● Detects CBRN hazards through monitoring and controlling surveys.</li> <li>● Provides early warning of contamination for supported units.</li> <li>● Presumptively identifies known agents and materials.</li> <li>● Locates, identifies, marks, reports, and identifies bypass routes around contaminated areas to prevent casualties and limit the spread of contamination.</li> <li>● Coordinates evacuation of CBRN samples.</li> <li>● Provides limited environmental monitoring/surveying when not in a CBRN environment.</li> <li>● Is capable of engaging Level I threats.</li> </ul>
<p><b>Organizational dependencies:</b></p> <ul style="list-style-type: none"> <li>● Requires sustainment (supply, maintenance, recovery) in excess of 12 to 24 hours.</li> <li>● Requires dismounted platforms and may have a CLS element for DS level work, parts, and tools.</li> <li>● Requires decontamination support if contaminated during reconnaissance missions.</li> </ul>
<p><b>Allocation rules:</b></p> <ul style="list-style-type: none"> <li>● Requires future (one organic to each).</li> <li>● Requires MLG and MAW (assigned to HQ).</li> </ul>

**Table K-2. CBRN reconnaissance platoon (NBC reconnaissance system) (continued)**

<b>Legend:</b>	
CBRN	chemical, biological, radiological, and nuclear
CLS	contracted logistics support
CM	consequence management
DS	direct support
HQ	headquarters
MAW	Marine aircraft wing
MLG	Marine logistics group

K-19. The NBC reconnaissance system is the current system used by the USMC. The vehicle system requires a crew of three CBRN specialists (MOS 5711).

**CHEMICAL, BIOLOGICAL, RADIOLOGICAL, AND NUCLEAR RECONNAISSANCE PLATOON**

K-20. The MAGTF CBRN set is a suite of specialized CBRN detection and protection equipment that will be used by MAGTF CBRN defense personnel (MOS 5702/5711) and other trained personnel in CBRN consequence and TIM assessment operations. Configured with three, four-man reconnaissance teams, hot-zone controller, cold-zone controller and an on-scene commander with additional support provided within the MSC (security, decontamination [provided by the platoon or augments], communications, administrative, medical, EOD). The MAGTF CBRN set of equipment will increase the MAGTF commander’s CBRN monitor/survey and reconnaissance capability by permitting operations into known and unknown environments and by providing the MAGTF commander with an increased CBRN and TIM detection and identification capability. Primarily employed in a dismounted CBRN reconnaissance role, these teams may be employed in general support of other organizations or in direct support of the parent organization. The employment of equipment will be according to the unit SOP as guided by Title 29 Code of Federal Regulations (CFR), 19 10.120. (See figure K-3 for the CBRN reconnaissance platoon organization.)

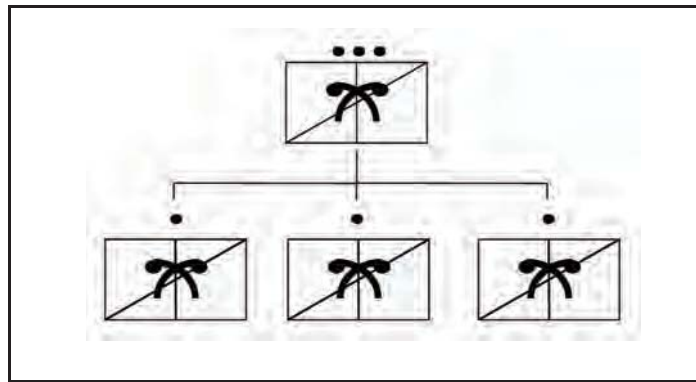

**Figure K-3. CBRN reconnaissance platoon (MAGTF CBRN consequence set)**

**FUTURE MOBILE CHEMICAL, BIOLOGICAL, RADIOLOGICAL, AND NUCLEAR RECONNAISSANCE PLATOON**

K-21. The USMC method for conducting CBRN mobile reconnaissance will use Marines with the appropriate array of detection/identification/protection equipment suitable for the mission. They are configured with three squads (six crews) in six mobile CBRN reconnaissance systems, primarily employed in a mobile CBRN reconnaissance role. (See figure K-4, page K-8, for the future mobile CBRN reconnaissance platoon organization.)

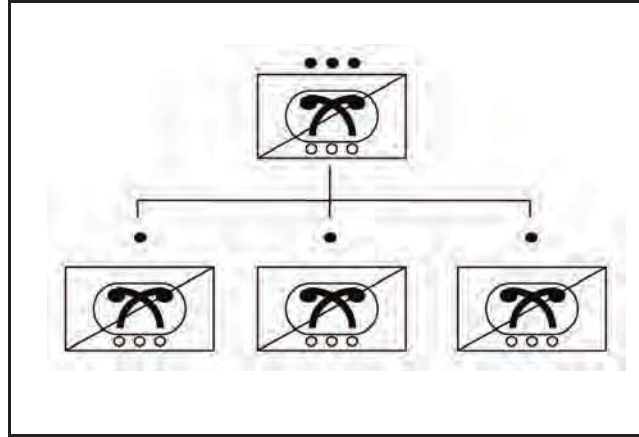

**Figure K-4. Future mobile CBRN reconnaissance platoon**

**CHEMICAL, BIOLOGICAL, RADIOLOGICAL, AND NUCLEAR RECONNAISSANCE TEAMS**

K-22. Battalions and squads that function as integral units during combat operations will be trained and equipped to conduct local area surveillance and monitoring as outlined in *Multiservice Tactics, Techniques, and Procedures for Nuclear, Biological, and Chemical Reconnaissance*. Team members will normally come from the unit command element (headquarters and service company). Teams will be task-organized to perform their reconnaissance missions based on mission requirements and the commander’s priorities. Teams will be capable of detecting and identifying TIM agents when the appropriate Level I and II detectors become available. (See table K-3 for reconnaissance teams personnel requirements.)

**Table K-3. Subordinate command reconnaissance members**

<i>Subordinate Command Reconnaissance Team Members</i>	<i>Rank</i>
Recon team NCOIC (1 per team)	SGT
Recon team leader (1 per section)	CPL
Recon team member (3 per section)	LCPL
<b>Legend:</b>	
CPL	corporal
LPCL	lance corporal
NCOIC	noncommissioned officer in charge
recon	reconnaissance
SGT	sergeant

- K-23. The reconnaissance teams provide the commander with the ability to—
- Rapidly confirm or deny information obtained from Level I detectors.
  - Establish detector arrays (planned future capability).
  - Assist in the collection of radiation exposure data.
  - Operate Level II detectors.
  - Conduct surveillance and/or monitoring of NAIs or AOs.
  - Conduct surveillance and/or monitoring during command post movement.

**AERIAL RECONNAISSANCE TEAMS**

K-24. Aerial reconnaissance may be used to support the MAGTF radiological and nuclear reconnaissance efforts. Personnel from any MOS can make up the aerial reconnaissance teams.

## CHEMICAL, BIOLOGICAL, RADIOLOGICAL, AND NUCLEAR DECONTAMINATION UNITS

K-25. Decontamination teams are task-organized within each CBRN platoon. Decontamination teams are the backbone of the MAGTF decontamination capability. Teams are trained and equipped in a manner that facilitates task organization and tailoring toward specific decontamination operations. Teams must be capable of rapid employment through the use of organic vehicles that have been dedicated to the teams. Teams are force-multiplied to support sustained operations. (See figure K-5, for more information on the CBRN decontamination platoon.)

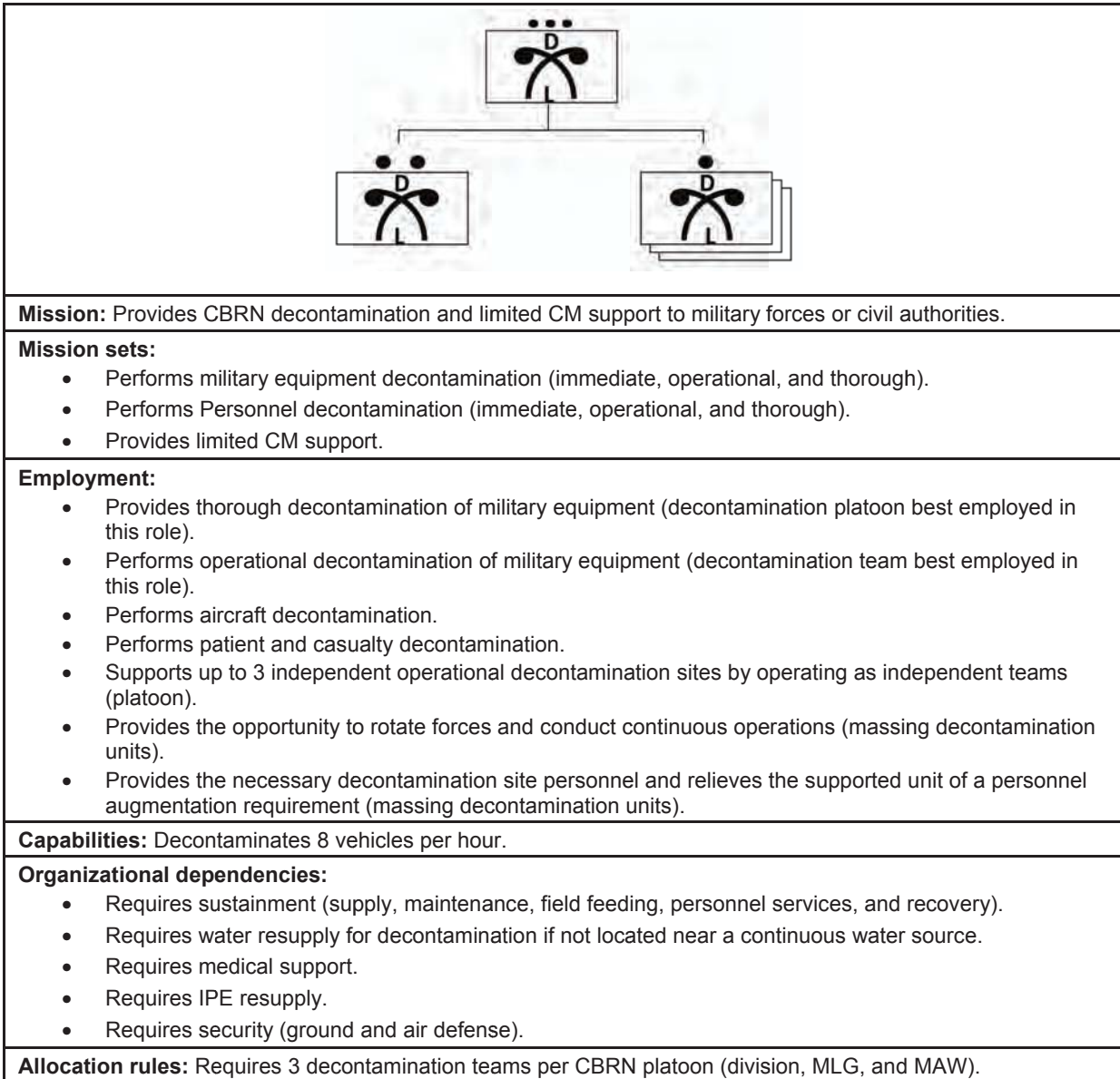

Figure K-5. CBRN decontamination platoon

<b>Legend:</b>	
CBRN	chemical, biological, radiological, and nuclear
CM	chemical
D	decontamination
IPE	individual protective equipment
L	light
MAW	Marine aircraft wing
MLG	Marine logistics group

**Figure K-5. CBRN decontamination platoon (continued)**

**MAJOR SUBORDINATE COMMAND DECONTAMINATION TEAMS**

K-26. Each MSC has a decontamination team (comprised of CBRN defense specialists) that is task-organized as required to support MAGTF operations. The team organization is based on providing one decontamination section for each MSC element, regiment, or Marine aircraft group and five for each Marine logistics group. Each section is staffed with one section leader and three section members for a total of four personnel. Teams will be task-organized to perform operational decontamination missions based on mission requirements and the commander’s priorities. (See table K-4 for information on how the teams are organized within the operating force.) (See table K-5 for the team billets, rank, and training requirements.) CBRNCC operations coordinator will direct task organization and employment and coordinate the support for the team. The actual concept of employment will be initially based on the vulnerability analysis and adjusted as required in response to a CBRN incident. Each operational decontamination section is trained and equipped to support casualty decontamination, MOPP drop, MOPP gear exchange, and vehicle/aircraft washdown.

**Table K-4. MSC decontamination teams**

<i>Unit</i>	<i>Total Decontamination Sections</i>
HQ battalion, 1st Marine division	1 team of 5 sections
HQ battalion, 2d Marine division	1 team of 5 sections
HQ battalion, 3d Marine division	1 team of 4 sections
H&S battalion, 1st MLG	1 team of 5 sections
H&S battalion, 2d MLG	1 team of 5 sections
H&S battalion, 3d MLG	1 team of 5 sections
MWHS, 1st MAW	1 team of 4 sections
MWHS, 2d MAW	1 team of 5 sections
MWHS, 3d MAW	1 team of 5 sections
<b>Legend:</b>	
H&S	headquarters and service
HQ	headquarters
MAW	Marine aircraft wing
MLG	Marine logistics group
MWHS	Marine wing headquarters squadron

**Table K-5. MSC decontamination team members**

<i>Operational Decontamination Team Member</i>	<i>Rank</i>	<i>Training</i>
Decontamination team NCOIC (1 per team)	SGT	CBRN Basic Course
Decontamination section leader (1 per section)	CPL	CBRN Basic Course
Decontamination section member (3 per section)	LCPL	CBRN Basic Course



**Table K-5. MSC decontamination team members (continued)**

<b>Legend:</b>	
CBRN	chemical, biological, radiological, and nuclear
CPL	corporal
LCPL	lance corporal
NCOIC	noncommissioned officer in charge
SGT	sergeant

## **MARINE AIR-GROUND TASK FORCE CHEMICAL, BIOLOGICAL, RADIOLOGICAL, AND NUCLEAR SUPPORT**

K-27. The USMC has approximately 110 CBRN defense officers and 800 CBRN defense specialists on active duty, spread across its force and assigned at the detachment, battalion, or squadron level and higher. The active duty, component can be augmented by the USMC reserve forces. Reserve forces have approximately 32 CBRN defense officers and 200 CBRN defense specialist, spread throughout the nation. If required, this force can integrate seamlessly with the active duty MAGTF. The size and composition of a MAGTF and a CBRN unit depend on METT-T. To conduct CBRN operations effectively, the force requires a clear understanding of the mission, command relationships, and available resources. Since the USMC has a limited number of MOS-qualified CBRN specialists (MOS 5702 and MOS 5711), these specialists are placed where they will have the greatest impact on overall mission accomplishment. This means that positions on CBRN reconnaissance and decontamination teams will be augmented with non-CBRN defense specialists to assist CBRN specialists with their duties. Based on this information, the MAGTF commander considers the following when conducting operations:

- CBRN personnel and equipment organic to the units assigned to, or under the operational control of, the MAGTF.
- Availability of CBRN specialists (MOS 5702 and MOS 5711) and collateral duty CBRN-trained augments (reconnaissance/decontamination).
- Additional CBRN equipment and personnel available from other agencies (Services, JTF).
- MAGTF command and support relationships.

K-28. Echelons of command must supervise and reinforce the CBRN efforts of subordinate elements. Each commander in a MAGTF must prepare and implement CBRN measures while also ensuring that their subordinates can operate in a CBRN environment. Units must be capable of performing the following essential operations:

- Detecting and identifying CBRN agents and materials.
- Warning of and reporting CBRN attacks and hazards.
- Performing individual- and collective-protection measures.
- Decontaminating personnel, equipment, and terrain as required.
- Administering first aid and following unit medical operations and exposure guidance.

K-29. Regardless of the unit size or the mission, principles essential to CBRN remain constant—only the scope will vary. The following principles help determine the structure of effective CBRN teams and units:

- Lowest level of organization required to function as an independent unit must possess the capability to survive and accomplish specialized tasks in a CBRN environment.
- Higher units or formations must also be capable of accomplishing their own mission and supporting subordinate units if required.
- Specific personnel must be designated and trained for specific CBRN responsibilities.

### **COMMAND ELEMENT**

K-30. The command element coordinates reconnaissance/survey operations, coordinates surveillance/monitoring operations, and coordinates and monitors decontamination operations. It maintains close coordination with intelligence assets to exchange CBRN reconnaissance/survey intelligence. The command element is also responsible for collecting, collating, analyzing, and disseminating surveillance/monitoring information. Headquarters and service unit CBRN teams conduct CBRN



operations for the command element. Many different units on the battlefield will be in a position to report CBRN activity; therefore, the command element must be prepared to establish a CBRNCC that is capable of continuous operations.

## **GROUND COMBAT ELEMENT**

K-31. The ground combat element company and battalion teams organize as elements of their respective units. Since the threat of a CBRN attack is equal to ground combat units, the ground combat element commander normally leaves CBRN assets with the parent organization. The Marine division CBRN platoon is placed in a general support or direct support role based on the CBRN threat and the ability to facilitate future operations. If augmentation is required, the officer in charge of the ground combat element CBRNCC coordinates with the officer in charge of the Marine expeditionary force CBRNCC. Augmentation provided is based on assets available and operational priorities.

### **Marine Division**

K-32. The division operations section (G-3) contains the CBRN platoon. Personnel required to staff a CBRNCC are drawn from this section. In addition to performing control center functions at the division level, CBRN personnel supervise overall CBRN operations planning, organization, and readiness of subordinate units. This section can also perform other CBRN duties (reconnaissance, decontamination with equipment from the supported unit). The division CBRN officer advises the commander and coordinates CBRN efforts.

### **Regiment**

K-33. The regiment CBRN needs are met with as little rearrangement of existing personnel and equipment as possible. The regimental commander assigns the CBRN officer as the officer in charge and task-organizes organic assets. If additional assistance is required, the regimental commander requests reinforcement from higher headquarters. Regiments are normally staffed with a CBRN officer (MOS 5702) to assist the commander and staff in CBRN operations. Normally, one CBRN NCO and one CBRN specialist (MOS 5711) are assigned to assist the CBRN officer. Other Marines may be assigned the responsibilities of CBRN NCOs as additional duties. The regiment CBRN officer advises the commander and coordinates CBRN efforts.

### **Battalions**

K-34. Unit CBRN needs are met with as little rearrangement of existing personnel and equipment as possible. Battalions are normally staffed with a CBRN officer (MOS 5702) to assist the commander and staff in CBRN operations. Normally, one CBRN NCO and one CBRN specialist (MOS 5711) are assigned to assist the CBRN officer. Other Marines may be assigned the responsibilities of CBRN augmentees (reconnaissance and decontamination team noncommissioned officers in charge [NCOICs] and members). The battalion CBRN officer advises the commander and coordinates CBRN efforts.

### **Companies**

K-35. Company commanders organize and train CBRN teams and other CBRN personnel according to unit SOPs and directives issued from higher headquarters. During actual CBRN operations, CBRN-trained personnel can be assigned to full-time CBRN duties. Although CBRN specialists are not located at all levels, companies are still required to conduct individual and unit training according to Marine Corps Order (MCO) 3400.3F.

## **GROUND COMBAT ELEMENT CHEMICAL, BIOLOGICAL, RADIOLOGICAL, AND NUCLEAR CONTROL CENTER**

K-36. The ground combat element CBRNCC collects, evaluates, and collates, information concerning friendly and enemy CBRN operations to the commander; his/her staff; and higher, adjacent, and supporting units. Specifically, the ground combat element CBRNCC—

- Plans the employment of CBRN detectors and sensors.
- Disseminates tasks of the CBRN reconnaissance and decontamination teams.
- Disseminates overall unit CBRN guidance.
- Performs the computations needed to convert basic CBRN information into the required form.
- Evaluates, plots, displays and disseminates CBRN information.

K-37. Each command has an organized and trained CBRNCC team. The CBRNCC is normally located within the combat operations center. This facilitates close coordination with other elements/sections (the operations section, intelligence section, fire support coordination center).

K-38. Commanders and their staffs use the information collected and processed by the ground combat element CBRNCC team to assist them in their decisionmaking process.

## **AVIATION COMBAT ELEMENT**

K-39. The current structure of the Marine aircraft wing includes the CBRN officers and specialists (MOS 5702 and 5711) that are required to sustain foreseeable CBRN operations. Additional support is requested through the command element CBRNCC.

### **Marine Aircraft Wing Headquarters**

K-40. The Marine aircraft wing G-3 contains the CBRN personnel required to staff an aviation combat element Marine air-ground task force (ACE) CBRNCC. This center is normally located in the tactical air command center. These personnel perform overall CBRN planning, organization, and readiness for their units. The organization of CBRN officers and specialists assigned to various units ensure that there is a coordinated effort to accomplish CBRN missions.

### **Marine Aircraft Group**

K-41. The MAG CBRN section consists of one CBRN officer (MOS 5702) and several CBRN specialists (MOS 5711). The Marine aircraft group is the lowest Marine aircraft wing level with a CBRN specialist (with the exception of the Marine wing support squadron). When attached to subordinate units, Marine aircraft group CBRN personnel provide guidance on CBRN matters and coordinate with the Marine support squadron concerning aspects of immediate and operational decontamination, contamination control, and CBRN reconnaissance.

### **Squadron/Battalion**

K-42. Squadron/battalion CBRN officers and CBRN specialists are normally consolidated at the Marine aircraft group level (except for the Marine wing support squadron). This allows the centralized control of equipment maintenance, CBRN warning and reporting, and CBRN training. Although CBRN specialists are not located at all levels, squads are still required to conduct individual and unit training according to MCO 3400.3F.

### **Marine Wing Support Squadron**

K-43. The Marine wing support squadron CBRN section has a decontamination station supervisor for each type of detailed decontamination. It also has a contamination control supervisor and a CBRNCC that may be attached to the ACE. It may be necessary to obtain augmentation from the other squadrons within the group to fully staff the control center.

## **Aviation Combat Element Chemical, Biological, Radiological, and Nuclear Control Center Team**

K-44. Although Marine aircraft wing squadrons are not required to establish an ACE CBRN control center team, they must be prepared to submit NBC 1 and 4 reports to higher headquarters. The ACE CBRNCC collects, evaluates, and collates information concerning friendly and enemy CBRN operations and then disseminates the information to the commander; his/her staff; and higher, adjacent, and supporting units. Specifically, the ACE CBRNCC—

- Plans the employment of CBRN detectors and sensors.
- Disseminates tasks to the CBRN reconnaissance and decontamination teams.
- Disseminates overall unit CBRN guidance.
- Performs the computations needed to convert basic CBRN information into the required form.
- Evaluates, plots, displays, and disseminates CBRN information.

## **LOGISTICS COMMAND ELEMENT**

K-45. Logistics command element battalions possess the equipment and personnel required to perform CBRN operations. The CBRN decontamination unit is organized and attached to the logistics command element based on the CBRN threat.

### **Marine Logistics Group**

K-46. The Marine logistics group G-3 contains a CBRN platoon that consists of CBRN officers and CBRN specialists. Elements of this platoon are used to—

- Form the logistics command element CBRNCC.
- Coordinate, evaluate and, if necessary, augment CBRN operations conducted within the Marine logistics group AO.
- Provide the nucleus of a reinforced platoon or provisional unit to support MAGTF operations with thorough decontamination and reconnaissance support as directed by the MAGTF command element.

### **Regiment**

K-47. Regiment CBRN needs are met with as little rearrangement of existing personnel and equipment as possible. The regimental commander assigns the CBRN officer as the officer in charge and task-organizes organic assets. If additional assistance is required, the regimental commander requests reinforcement from higher headquarters. Regiments are normally staffed with a CBRN senior NCO (MOS 5711) to assist the commander and staff in CBRN operations. Normally, one CBRN NCO and one CBRN specialist (MOS 5711) are assigned to assist the CBRN senior NCO. Other Marines may be assigned the responsibilities of CBRN NCOs as additional duties. The regiment CBRN senior NCO advises the commander and coordinates CBRN efforts.

### **Battalions**

K-48. Unit CBRN needs are met with as little rearrangement of existing personnel and equipment as possible. Battalions are normally staffed with a CBRN NCO (MOS 5711) to assist the commander and staff in CBRN operations. Normally, one CBRN specialist (MOS 5711) is assigned to assist the CBRN NCO. Other Marines may be assigned the responsibilities of CBRN augmentees (reconnaissance and decontamination team NCOICs and members). The battalion CBRN officer advises the commander and coordinates CBRN efforts.

### **Companies**

K-49. Company commanders organize and train CBRN teams and other CBRN personnel according to unit SOPs and directives issued from higher headquarters. During actual CBRN operations, CBRN-trained

personnel can be assigned to full-time CBRN duties. Although CBRN specialists are not located at all levels, companies are still required to conduct individual and unit training according to MCO 3400.3F.

**Logistics Combat Element Chemical, Biological, Radiological, and Nuclear Control Center**

K-50. The logistics combat element CBRNCC collects, evaluates, and collates information concerning friendly and enemy CBRN operations and then disseminates the information to the commander; his/her staff; and higher, adjacent, and supporting units. Specifically, the logistics combat element CBRNCC—

- Plans the employment of CBRN detectors and sensors.
- Disseminates tasks to the CBRN reconnaissance and decontamination teams.
- Disseminates overall unit CBRN guidance.
- Performs the computations needed to convert basic CBRN information into the required form.
- Evaluates, plots, displays, and disseminates CBRN information.

**U.S. MARINE CORPS CHEMICAL, BIOLOGICAL, RADIOLOGICAL, AND NUCLEAR STAFF**

K-51. CBRN staffs exist at all levels of command. CBRN staff sections exist at the Marine expeditionary force, division, Marine logistics group, Marine aircraft wing, regiment/Marine aircraft group, and battalion level and are organized as part of the special staff. In addition to common staff responsibilities, the CBRN staff-specific responsibilities fall into four basic activities of the operations process: assessment, planning, preparation and execution. (See table K-6, for CBRN staff responsibilities.)

**Table K-6. CBRN special staff responsibilities**

<p><b>Assessment:</b></p> <ul style="list-style-type: none"> <li>● Conducts CBRN threat assessment as an integral part of the staff IPB process.</li> <li>● Conducts an assessment of the operational environment—to include terrain, weather, and civil considerations.</li> <li>● Conducts CBRN vulnerability assessment as an integral part of the commander’s risk management process.</li> <li>● Conducts CBRN capabilities assessment of friendly assets</li> </ul>
<p><b>Planning:</b></p> <ul style="list-style-type: none"> <li>● Provides technical advice and planning recommendations on CBRN ISR operations.</li> <li>● Provides technical advice and planning recommendations on CBRN decontamination operations.</li> <li>● Provides technical advice and recommendations on MOPP level, troop safety criteria, OEG, and vulnerability mitigation measures.</li> <li>● Plans and recommends the use of FFEs to supplement unit defense and existing minefield sand barriers.</li> <li>● Plans and manages CBR surveying and monitoring operations.</li> <li>● Participates in targeting meetings, serving as the CBRN SME.</li> <li>● Assesses weather and terrain data to determine if environmental factors favor the enemy employment of WMD.</li> <li>● Plans and initiates, in conjunction with the surgeon, procedures to verify and report enemy first use of CBRN agents.</li> <li>● Predicts fallout from the friendly employment of nuclear weapons and disseminate nuclear strike warning messages when required.</li> <li>● Estimates the effect of the unit radiation exposure state on mission assignments.</li> <li>● Recommends COAs to minimize friendly and civilian CBRN vulnerability.</li> <li>● Estimates the consumption rates of CBRN defense equipment and supplies.</li> <li>● Assesses and adjusts the staff estimate continuously.</li> </ul>

Table K-6. CBRN special staff responsibilities (continued)

<b>Preparation:</b>	
<ul style="list-style-type: none"> <li>• Coordinates across the entire staff while assessing the impact of enemy CBRN-related attacks and hazards on current and future operations.</li> <li>• Coordinates CBRN reconnaissance employment in the reconnaissance and surveillance plan.</li> <li>• Coordinates with medical personnel on HSS requirements for CBRN operations.</li> <li>• Maintains and reports the radiation exposure and total dose status in coordination with the medical staff.</li> <li>• Assesses the probability and impact of CBRN-related casualties.</li> <li>• Supervises and coordinates CBRN decontamination operations (except patient decontamination).</li> <li>• Coordinates with the logistics staff officer (G-4/S-4) on logistics as it relates to CBRN equipment and supplies, the maintenance of CBRN equipment, and the transportation of CBRN assets.</li> <li>• Assesses and adjusts the staff estimate continuously.</li> </ul>	
<b>Execution:</b>	
<ul style="list-style-type: none"> <li>• Manages the CBRNWRS.</li> <li>• Prepares CBRN SITREPs.</li> <li>• Supervises the nuclear and chemical accident and incident response assistance program.</li> <li>• Collates, evaluates, and distributes CBRN attack and contamination data.</li> <li>• Advises the commander, in conjunction with the surgeon, on the possible effects of low-level hazards, to include TIM.</li> <li>• Advises the commander on the use of RCAs.</li> <li>• Advises the commander on WMD elimination operations and the effects of destroying enemy WMD sites.</li> <li>• Assesses and adjusts the staff estimate continuously.</li> </ul>	
<b>Legend:</b>	
CBR	chemical, biological, and radiological
CBRN	chemical, biological, radiological, and nuclear
CBRNWRS	chemical, biological, radiological, and nuclear warning system
COA	course of action
FFE	flame field expedients
G-4	assistant chief of staff for logistics
HSS	health service support
IPB	intelligence preparation of the battlefield
ISR	intelligence, surveillance, and reconnaissance
MOPP	mission-oriented protective posture
OEG	operational exposure guide
RCA	riot control agent
S-4	logistics staff officer
SITREP	situation report
SME	subject matter expert
TIM	toxic industrial material
WMD	weapons of mass destruction

### CHEMICAL, BIOLOGICAL, RADIOLOGICAL, AND NUCLEAR OFFICER

K-52. The duties and responsibilities of unit CBRN officers are determined by the level of assignment. In the broadest terms, their primary concern is the establishment of passive CBRN defense measures. CBRN officers—

- Advise the commander on CBRN readiness.
- Provide the commander with operational exposure guidance.
- Prepare the CBRN plans, orders, and instructions necessary to implement the commander's policies. This includes CBRN SOPs, orders, annexes, and inspections.
- Determine and recommend requirements for CBRN supplies and equipment.
- Are responsible for planning the joint equipment assessment unit program.

- Estimate personnel, equipment, and supply requirements to support the CBRN appendix of the operation order.
- Coordinate and develop CBRN training exercises.
- Evaluate unit CBRN readiness.
- Supervise operation of the CBRNCC.
- Provide recommendations for training the command according to MCO 3400.3F and for training CBRN specialists according to MCO 3500.70. (This includes formal school quotas.)
- Plan and make recommendations for decontamination functions.
- Provide information (in conjunction with the S-2) concerning CBRN organization, weapons, equipment, and techniques that are indicative of enemy preparations for a CBRN attack.
- Provide information (in conjunction with the S-2) concerning the effects of terrain and weather on the enemy and friendly employment of riot control agents.
- Determine CBRN reconnaissance (in conjunction with the intelligence staff officer) required in areas or routes intended for use by friendly troops.
- Plan CBRN monitoring/surveying operations within the unit AO.
- Advise on the assignment of CBRN-trained personnel.
- Monitor the employment of CBRN teams.
- Notify commanders if contaminated areas are present within the AO.
- Train unit level individuals in the effective use of individual CBRN protective items according to MCO 3400.3F.
- Advise CBRN reconnaissance teams of routes and areas to be occupied.
- Supervise the preparation of NBC reports.
- Perform other duties as directed.

### **CHEMICAL, BIOLOGICAL, RADIOLOGICAL, AND NUCLEAR SPECIALIST**

K-53. CBRN specialist billets are incorporated into the USMC table of organization (listed as CBRN NCOs) commands down to the battalion level. The CBRN specialist, like the CBRN officer, is a member of the operations section. The specialist maintains unit CBRN equipment, trains Marines in CBRN measures and protection, and advises the unit CBRN officer on CBRN matters. Specific training standards are listed in MCO 3500.70. The duties of the CBRN specialist vary with the level of command. The CBRN specialist should be prepared to assist the CBRN officer. CBRN specialists—

- Assist the CBRN officer in the execution of his/her duties.
- Assist the CBRN officer in ensuring that CBRN SOPs are up-to-date and effectively promulgated.
- Execute and monitor the joint equipment assessment unit plan.
- Maintain CBRN publications.
- Recommend unit CBRN training requirements.
- Ensure that the consolidated storage facility maintains CBRN equipment.
- Ensure that the consolidated storage facility sizes and fits protective masks.
- Organize and train CBRN teams.
- Plan CBRN monitoring/surveying operations.
- Supervise monitoring/surveying operations.
- Supervise unit level operational decontamination.
- Ensure that CBRN equipment is turned in upon completion of training or as required for conducting maintenance and serviceability inspections.
- Assist and monitor required individual training.



## CHEMICAL, BIOLOGICAL, RADIOLOGICAL, AND NUCLEAR CONTROL CENTER

K-54. The CBRNCC monitors and coordinates CBRN operations. It is also responsible for collecting, collating, analyzing, and disseminating CBRN-related information. CBRN information may come from many different agencies or units. As a general rule, CBRN information gathering focuses on early warning of CBRN attacks, locations of contaminated areas, decontamination sites, and routes from contaminated areas to decontamination sites. The CBRNCC provides the commander with information that supports rapid decisionmaking. This ensures that the commander is able to maintain his/her desired operating tempo, while emphasizing to the enemy commander that CBRN employment is ineffective against U.S. forces. The CBRNCC monitors and coordinates CBRN operations and is the hub for CBRN battle management within the MAGTF. (See figure K-6 for a depiction of how the CBRNCC forms the hub for CBRN operations.)

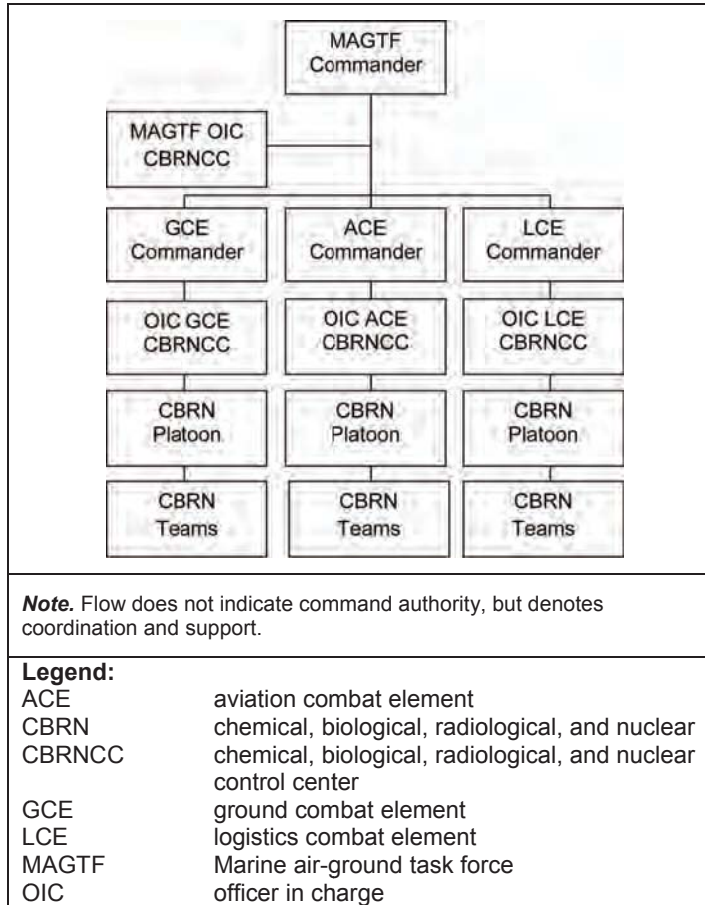

**Figure K-6. CBRNCC**

## MARINE AIR-GROUND TASK FORCE COMMAND ELEMENT

K-55. The MAGTF command element CBRNCC is the overall coordinator for CBRN operations within the MAGTF. The CBRNCC is resident within the G-3, and current operations section, and requires a minimum of six personnel. The CBRNCC is capable of continuous operations. It maintains close coordination with intelligence assets to exchange CBRN reconnaissance, surveillance, and monitoring intelligence. The headquarters and service unit is responsible for conducting the local CBRN operations necessary to support itself and the command element. Unit NBC reports will go directly to the CBRNCC. (See table K-7 for a description the MAGTF CBRNCC members.)



**Table K-7. MAGTF command element CBRNCC**

<i>Rank</i>	<i>Billet Description</i>
CWO 5	OIC, CBRN officer
CWO 4	Assistant OIC, assistant CBRN officer
CWO 3	JWARN operator
MGY SGT	Operations coordinator
MSG	Operations coordinator
GYSGT	JWARN operator
<b>Legend:</b>	
CBRN	chemical, biological, radiological, and nuclear
CWO	chief warrant officer
GYSGT	gunnery sergeant
JWARN	joint warning and reporting system
MGY SGT	master gunnery sergeant
MSG	master sergeant
OIC	officer in charge

### **Officer in Charge**

K-56. The CBRNCC officer in charge is a special staff officer who supervises the overall operation of the CBRNCC. The duties include the following:

- Coordinate CBRN-related issues that involve or impact other staff sections. This coordination requires direct lines of communication to the medical, logistics, intelligence, personnel, and other staff sections.
- Supervise the operations coordinator. CBRN operations must be reviewed by the officer in charge and approved by the appropriate watch officer prior to execution.
- Supervise the JWARN operator. The MAGTF CBRNCC is the only CBRNCC within the MAGTF that can assign a strike serial number to a NBC report. The officer in charge must approve strike serial number assignments.
- Approve reports and overlays before they are posted or disseminated.
- Represent the CBRNCC by participating in staff briefings.
- Be capable of assuming any position within the CBRNCC.

### **Operations Coordinator**

K-57. The CBRNCC operations coordinator coordinates CBRN operations within the MAGTF. The duties include the following:

- Prepare a localized, overall CBRN vulnerability analysis for the MAGTF.
- Recommend the MOPP level for the MAGTF command element. Subordinate commands will establish their own MOPP level based on their vulnerability analysis and higher headquarters guidance or direction.
- Develop, implement, support, and supervise the MAGTF surveillance and monitoring plan.
- Develop, implement, support, and supervise the MAGTF CBRN reconnaissance missions.
- Collect and analyze surveillance, monitoring, and reconnaissance data; and prepare the appropriate NBC reports and overlays.
- Monitor subordinate commands' radiological exposure status and compile the MAGTF overall radiological exposure status. The recording and collection of individual exposure is a medical responsibility.
- Forward NBC reports and overlays to the JWARN operator, if necessary.
- Develop, implement, support, and supervise the MAGTF decontamination plan.
- Be capable of assuming any position within the CBRNCC.

**Joint Warning and Reporting Center Operator**

K-58. The JWARN operator must be able to receive and import reports and overlays directly into the C4I network. The duties include the following:

- Process chemical downwind messages and effective downwind messages as necessary to support the MAGTF AO.
- Collect, collate, and analyze CBRN information received from higher, adjacent, and subordinate CBRNCCs.
- Prepare and disseminate NBC reports, overlays, and information received from higher, adjacent, and subordinate CBRNCCs.
- Disseminate NBC reports, overlays, and information received from higher, adjacent, and subordinate CBRNCCs via C4I network.

**MAJOR SUBORDINATE COMMAND**

K-59. The ground combat element, ACE, and logistics combat element CBRNCCs coordinate CBRN operations within their command. The CBRNCC is resident within the G-3, and current operations section and requires a minimum of six personnel. The CBRNCC is capable of continuous operations. It maintains close coordination with intelligence assets to exchange CBRN reconnaissance, surveillance, and monitoring intelligence. The headquarters unit is responsible for conducting the CBRN operations necessary to support itself and the command element. Unit NBC reports will go directly to the CBRNCC. The MSC CBRNCC members' duties are the same as the MAGTF CBRNCC at the MSC level. (See table K-8 for the MSC CBRNCC members.)

**Table K-8. MSC CBRNCC**

<i>Rank</i>	<i>Billet Description</i>
CWO 4	OIC, CBRN officer
CWO 3	Assistant OIC, assistant CBRN officer
MSG	Operations coordinator
GYSGT	Operations coordinator
SSG	JWARN operator
SGT	JWARN operator
<b>Legend:</b>	
CBRN	chemical, biological, radiological, and nuclear
CWO	chief warrant officer
GYSGT	gunnery sergeant
MSG	master sergeant
OIC	officer in charge
SGT	sergeant
SSG	staff sergeant

*Note.* Adjacent command/MS CBRNCCs informally coordinate and share information with each other.

## **SUBORDINATE COMMAND**

K-60. Battalions, regiments, groups, and other designated units are staffed with one or more CBRN defense personnel (CBRN section) who coordinate CBRN operations within their command. The CBRN section is resident within the operations and training officer (S-3), and the total number of personnel varies depending on the type of unit. CBRN sections with two or more personnel assigned are capable of continuous operations. Subordinate commands must be able to communicate with the higher headquarters CBRNCC and are responsible for coordinating and/or conducting the CBRN operations necessary to support the command. The following is a description of CBRN section duties:

- Coordinate CBRN-related issues that involve or impact other staff sections and subordinate elements.
- Participate in staff briefings.
- Coordinate CBRN operations within the command.
- Coordinate support for those CBRN operations that are beyond the command's capability through the higher headquarters CBRNCC.
- Prepare the unit CBRN vulnerability analysis.
- Recommend the unit MOPP level. Subordinate companies and squadrons may need to be separately assessed; one MOPP level may not be appropriate for the entire unit.
- Develop, implement, support, and supervise the unit surveillance and monitoring plan.
- Ensure that unit staff and subordinate commands are aware of higher headquarters CBRNCC CBRN reconnaissance missions being conducted in the area.
- Collect surveillance and monitoring data, and prepare and forward the appropriate NBC reports to the higher headquarters CBRNCC.
- Receive and analyze NBC reports from the CBRNCC, and advise the staff on actions required to avoid or mitigate CBRN contamination.
- Compile the unit radiological exposure status, and forward it to the CBRNCC. The recording of individual exposure is a medical responsibility.
- Review the CBRNCC decontamination plan to ensure that it provides adequate support for the unit.
- Operate JWARN. Units staffed with the CBRN defense personnel (MOS 5702 and 5711) must be prepared to operate JWARN. JWARN use is dependent on the operational scenario. In those instances when the CBRN defense personnel are not able to operate JWARN, they must be able to manually produce, receive, plot, and record NBC reports.

K-61. The Joint NBC Reconnaissance System, subordinate command reconnaissance, and CBRN decontamination teams are task-organized and employed as necessary to support the MAGTF. They may be attached and report directly to a battalion, regiment, or group. The MAGTF CBRNCC will maintain an overall SA of how the NBC Reconnaissance System and decontamination teams are being employed and may take operational control of these assets when required. The operational scenario will dictate the means of communication used by the units, CBRN sections, and CBRNCCs to pass on NBC reports and overlays and communicate with CBRN teams. (See figures K-7 through K-9, pages K-22 through K-24, for more information on how the CBRNCC and reconnaissance and decontamination teams are coordinated throughout the Marine expeditionary force to support the MAGTF.)

---

*Note.* Marine Corps Warfighting Publication (MCWP) 3-37 provides a complete description of how the USMC plans and executes CBRN defense operations.

---

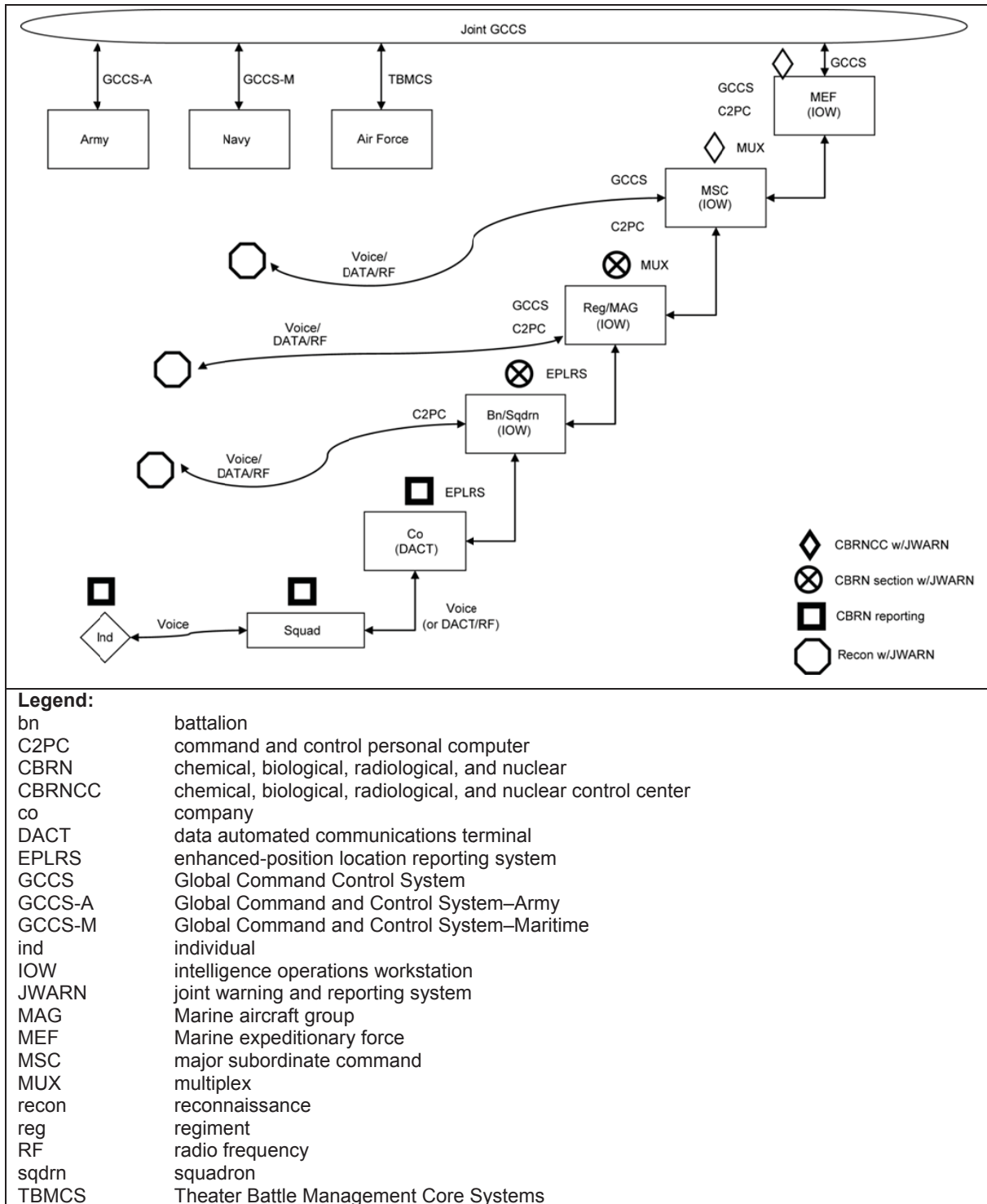

Figure K-7. CBRNCC coordination within the Marine expeditionary force

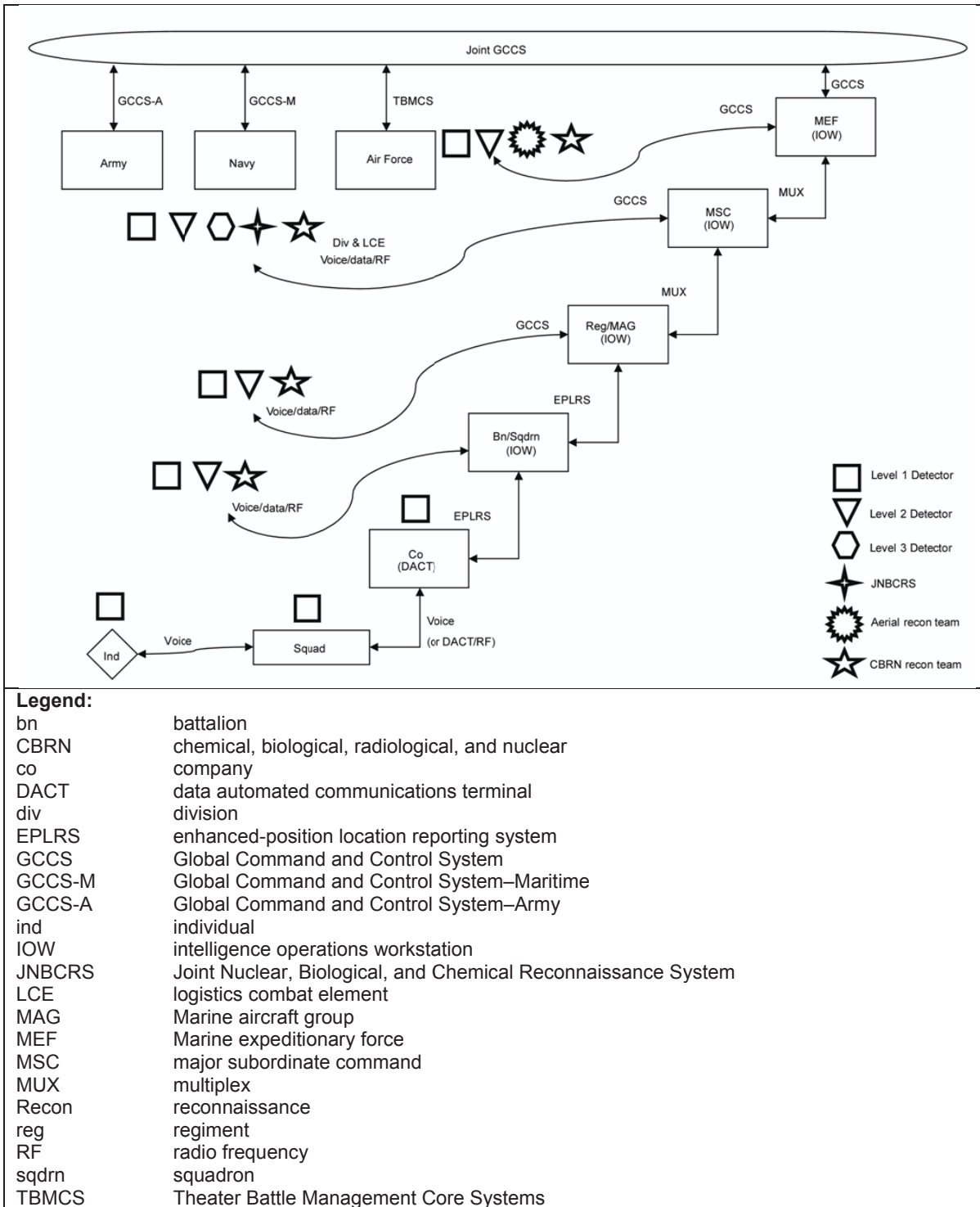

Figure K-8. CBRN reconnaissance coordination within the Marine expeditionary force

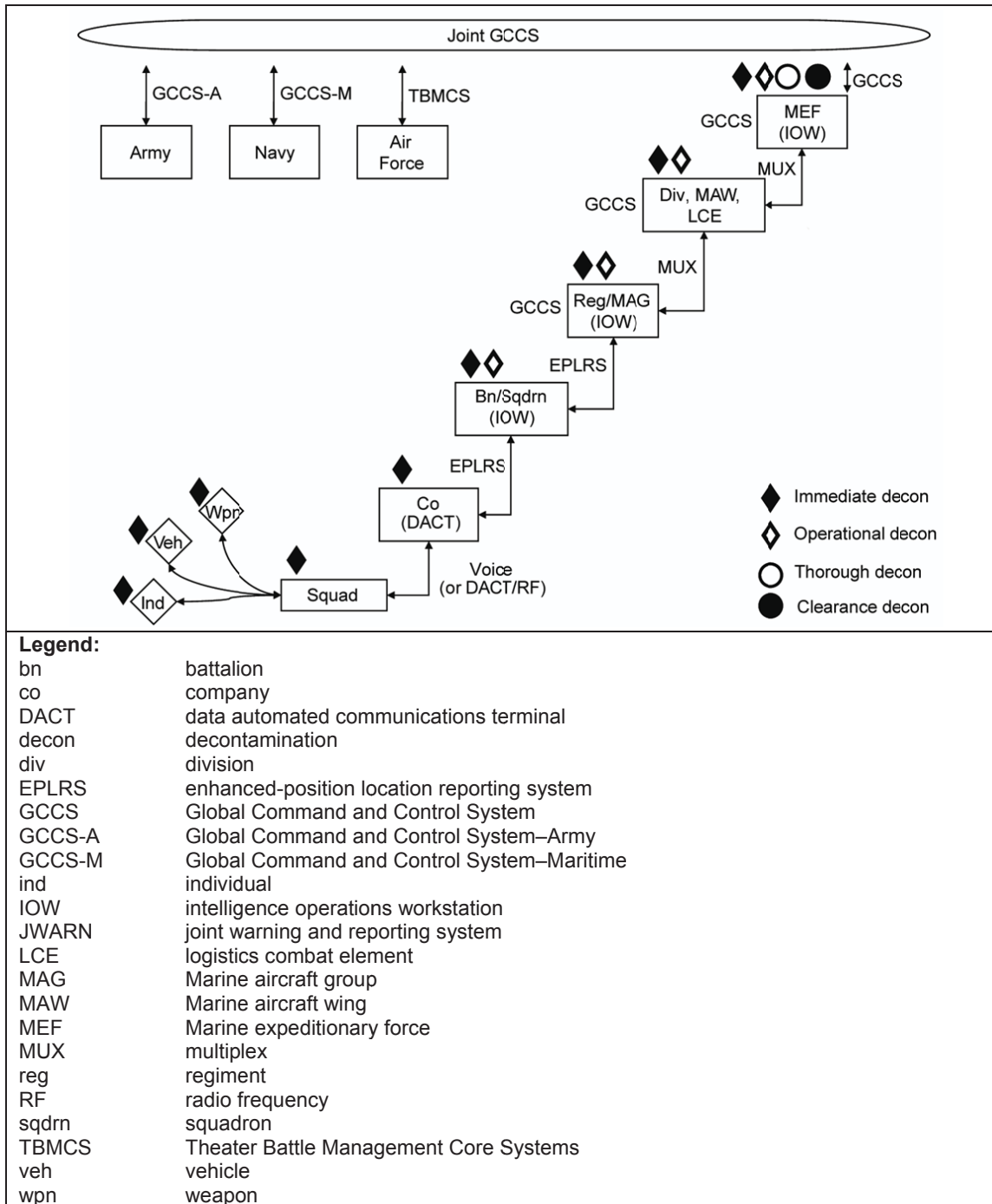

Figure K-9. CBRN decontamination coordination within the Marine expeditionary force

## Appendix L

# U.S. Navy Chemical, Biological, Radiological, and Nuclear Capabilities and Employment

This appendix provides a brief summary of the duties of key individuals on USN shipboard, aviation, and shore-based staffs with assigned CBRN defense responsibilities. This appendix also provides an overview of the capabilities that the USN has forward-deployed and readily available in-theater for use by the commander. Finally, this appendix presents a summary of the organization and functions of shore-based USN EOCs that facilitate the immediate response of appropriate USN specialists to CBRN incidents. (See appendix H for relevant USN reachback capabilities.)

## CHEMICAL, BIOLOGICAL, RADIOLOGICAL, AND NUCLEAR ORGANIZATIONS

L-1. Unlike the other Services, the USN has not developed unique career paths and associated cadres of dedicated CBRN defense specialists whose sole function is to advise and provide CBRN defense to USN operations. Alternatively, the USN uses the talent and expertise of its shipboard damage control specialists and its shore-based, all-hazard emergency responders to help maintain CBRN defense readiness. USN CBRN defense duties are assigned as an additional duty to individuals or already-established teams of personnel within its shipboard, aviation, and shore-based communities. CBRN defense resources are provided primarily by the Naval Sea Systems Command, Naval Air Systems Command, and Naval Facilities Engineering Command and are coordinated through unified commands.

## SHIPBOARD UNITS

L-2. Aboard USN ships, the damage control assistant under the engineer officer is responsible for ship survivability systems, to include the control of damage, control of stability, list, trim, fighting fires, restoration from damages, and CBRN defense measures. He/she trains and supervises the ship damage control teams in emergency response for combating hazardous materials and hazardous wastes. He/she is responsible for all-hands CBRN defense training. The shipboard damage control section, known as the "R" division and working under the damage control assistant, is composed of full-time damage control personnel and personnel from other divisions whose damage control responsibilities are limited. All have received baseline training in CB defense, and some have received much more extensive training in CB defense and become certified as shipboard instructors. These more qualified individuals are known as shipboard CBR defense operations and training specialists and senior enlisted damage control program management and training specialists. This organization, working out of its damage control center, advises the command on CBRN defense-related issues. Additional details concerning the CBRN defense planning and execution considerations carried out by shipboard damage control sections are listed within the CBRN chapters of Navy Tactics, Techniques, and Procedures (NTTP) 3-20.31. Duties of the damage control assistant include—

- Prepare directives to be signed by the commanding officer for CBRN functions requiring coordination of departments.
- Submit a schedule of all-hands CBRN training requirements (according to the surface force training manual).



- Maintain a damage control training syllabus and provide CBRN instructors for all-hands training.
- Train and supervise the ship damage control teams in emergency responses for combating hazardous materials/hazardous waste spills.
- Provide training to divisions regarding reporting, initial handling, and cleaning of hazardous materials/hazardous waste spills.

### AVIATION UNITS

L-3. In USN aviation units, the squadron commanding officer assigns one individual as the squadron CB defense officer to serve as the commanding officer's action officer for CB defense readiness. While on watch, the assigned squadron duty officer serves as the commanding officer's initial coordinator for CB defense.

L-4. Primary CBRN defense-related duties of the squadron CB defense officer include the following:

- Establish, implement, and periodically review the unit CB defense SOP for contamination avoidance, protection, and control.
- Establish decontamination and detection teams from unit personnel and equipment.
- Coordinate requirements for contamination avoidance, detection, and decontamination with unit department heads; and determine the host command's capability to support CB defense requirements.
- Establish and maintain unit CB defense training.
- Assist the department head's efforts to maximize unit CB defense readiness while maintaining the ability to meet mission-essential tasking.
- Keep the commanding officer informed of unit CB defense status, and make recommendations to improve training and readiness.

L-5. Primary CBRN defense-related duties of the on-watch squadron duty officer responsibilities include the following:

- Notify the commanding officer, executive officer, and key unit personnel of CB threats, warnings, and alarms.
- Take appropriate CB defense actions regarding aircraft, personnel, ready rooms, unit spaces, and shop areas.
- Monitor command CB defense response efforts; and keep the commanding officer, executive officer, and key unit personnel apprised.
- Establish and maintain communications with area, senior, and host commands in monitoring CB threat/attack alarms and warning information.
- Communicate CB defense status to aircraft with CO's instructions.

### SHORE-BASED UNITS

L-6. This command structure may be modified to meet the requirements and structure of specific regional and installation commands. (See figure L-1 for the baseline command structure that the Commander, Navy Installation Command has established for the USN installation emergency management program.)

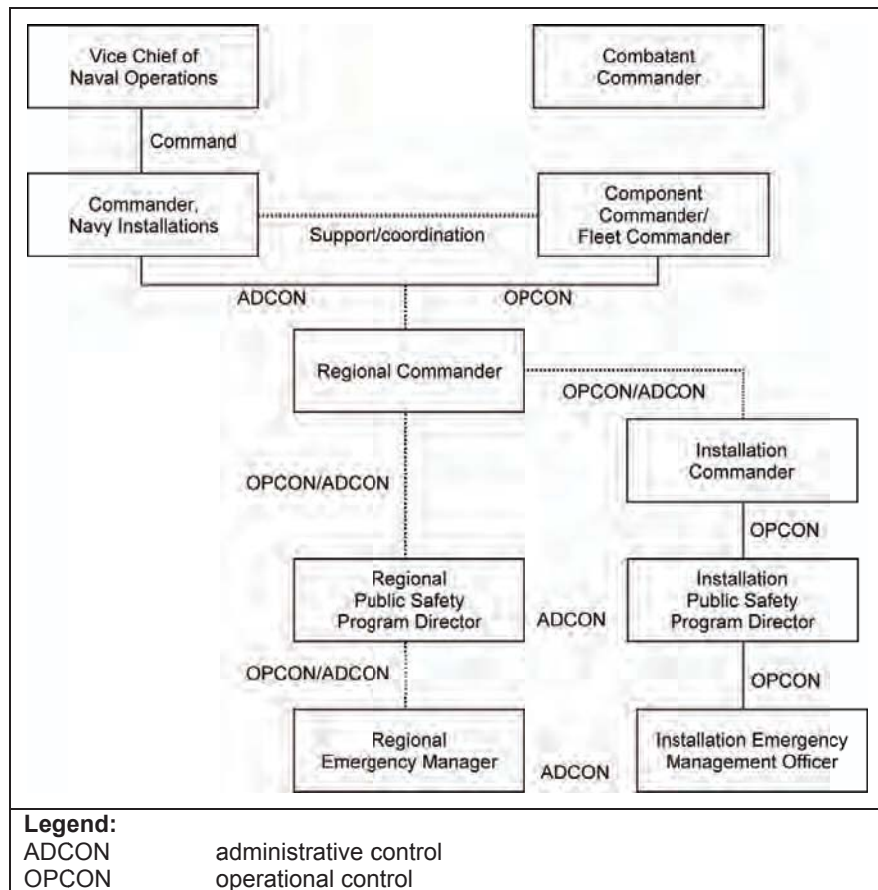

**Figure L-1. Navy emergency management command structure**

L-7. The Commander, Navy Installation Command, encompasses the following regional commands:

- Commander, Naval District Washington.
- Commander, Navy Region Mid-Atlantic.
- Commander, Navy Region Midwest.
- Commander, Navy Region Northwest.
- Commander, Navy Region Southeast.
- Commander, Navy Region Southwest.
- Commander, Navy Region Europe.
- Commander, Navy Region Hawaii.
- Commander, Navy Region Japan.
- Commander, Navy Region Korea.
- Commander, Navy Region Marianas.
- Commander, Navy Region Southwest Asia.

L-8. At the USN regional level, the regional emergency management functional manager is assigned responsibility for developing, coordinating, and executing the USN installation emergency management program within their assigned geographical area. As the senior dedicated emergency management official within a region, the regional emergency management provides management oversight, technical assistance, and specialized guidance on matters pertaining to the establishment, implementation, and sustainment of a comprehensive emergency management program that is capable of effective all-hazards preparedness, including CBRNE, prevention/mitigation, response, and recovery to save lives, protect property, and sustain mission readiness.

- L-9. USN regions located overseas typically have additional foreign consequence management (FCM) responsibilities and additional CBRN defense requirements identified in writing by their supported theater CCDR. As a result, some USN regions have been provided with contract CBRNE coordinators by the communication, navigation, and identification emergency management program and/or the Naval Facilities Engineering Command CBRN program. These contract personnel are fielded to assist with designated regional emergency management programs over a specified period of time. They address CBRNE-specific hazards within their programs, especially in the preparedness areas of planning, training, equipment fielding, inventory management, and limited exercises.
- L-10. At the USN installation level, the installation emergency management officer is assigned responsibility for preparing for, responding to, mitigating potential effects from, and recovering from natural and man-made hazards, including CBRNE events, which may affect their assigned installations. The installation emergency management officer is responsible for the management, administration, and operation of the installation EOC and installation dispatch center (if assigned). Specific USN installations located overseas may have FCM responsibilities and additional CBRN defense requirements identified in writing to their assigned regional commander by their supported theater CCDR.
- L-11. As discussed previously, some USN regions require specialized expertise that is provided in the form of contract CBRNE coordinators. Where multiple high-priority installations are located within close proximity as judged by communication, navigation, and identification emergency management, and where at least one of these installations also contains all or a component of the regional headquarters, a CBRNE coordinator may be provided to the regional emergency management program as the fleet concentration area CBRNE coordinator. In such cases, the fleet concentration area CBRNE coordinator will still directly support the regional emergency management program, but will be authorized to liaison directly with the appropriate installation emergency management point of contact.

## **NAVY FORWARD-DEPLOYED CHEMICAL, BIOLOGICAL, RADIOLOGICAL, AND NUCLEAR DEFENSE SUPPORT ASSETS**

- L-12. The following paragraphs provide a summary overview of the capabilities that USN forward deploys and makes readily available in theater for use by the commander. (See appendix H for additional relevant USN reachback capabilities.)

### **SUPPORT AFLOAT**

- L-13. Medical departments on aircraft carriers; aircraft carriers, nuclear; large-deck amphibious assault ships (general purpose); hospital ships; and command ships are equipped to provide confirmatory testing capability for environmental samples. They can receive, sample, test, report, package, and transport suspected biological warfare samples.

### **FORWARD-DEPLOYABLE PREVENTIVE MEDICINE UNIT**

- L-14. When deployed forward, the primary missions of the forward-deployable preventive medicine unit are to provide force health protection by rapidly assessing, preventing, and controlling health threats in a theater of operations and to enhance organic preventive medicine assets. A designated forward-deployable medicine unit will deploy to provide short-duration, specialized preventive medicine support. Its capabilities include the ability to identify and evaluate environmental health hazards (including CBR and physical agents), assess the risk of adverse health outcomes, monitor the health of deployed forces, and advise the operational commander on significant risks and recommended preventive medicine interventions. It can also provide technical assistance and field confirmatory analysis for CB agents.

## NAVY EMERGENCY OPERATIONS CENTERS

L-15. The following is a summary of the organization and functions of shore-based USN EOCs that serve to facilitate the immediate response of appropriate USN specialists to CBRN incidents ashore:

### TYPES

L-16. Operations centers (regional operations centers, installation EOCs) are the physical locations at which the coordination of information and resources to support incident management activities normally take place. The following are types of operations centers:

- **Incident command post.** It is located at or in the immediate vicinity of an incident site. Although primarily focused on the tactical on-scene response, an incident command post may also perform an operations-center-like function in smaller-scale incidents or during the initial phase of the response to larger, more complex events. Incident command posts, when established, are linked to the installation EOC and/or the regional operations center to ensure effective and efficient incident management.
- **Standing operations centers (or those activated to support larger, more complex events).** They are typically established in a more central or permanently established facility and at a higher level of organization within a jurisdiction.
- **USN operations centers.** They are organized by jurisdiction (combatant command; fleet; numbered fleet; communication, navigation, and identification; region; installation; medical treatment facility; and tenant command).
- **Departmental operations centers.** They are normally focused on internal agency incident management and response and are linked to and, in most cases, physically represented in a higher-level operations center.

### STRUCTURE

L-17. USN operations centers may be permanent organizations and facilities or may be established to meet temporary, short-term needs. The physical size, staffing, and equipping of an operations center will depend on the size of the jurisdiction, resources available, and anticipated incident management workload. Operations centers may be organized and staffed in a variety of ways, but regardless of the specific organizational structure used, they will include the following core functions: coordination; communications; resource dispatch and tracking; and information collection, analysis, and dissemination.

### MULTIAGENCY COORDINATION

L-18. Operations centers may also support multiagency coordination and joint information activities. Multiagency coordination entities typically consist of principals (or their designees) from organizations and agencies with direct incident management responsibility or with significant incident management support or resource responsibilities. These entities are sometimes referred to as crisis action teams, policy committees, incident management groups, executive teams, or other similar terms. For complex incidents, operation centers will be staffed by personnel representing multiple commands/agencies and functional disciplines and a wide variety of resources. For example, an installation EOC established in response to a bioterrorism incident would include a mix of emergency management personnel, Naval security forces, fire and emergency services, electromagnetic pulse, public health, and medical treatment facility providers (including representatives of medical treatment facilities, pharmaceutical repositories, and laboratories).

### CHARACTERISTICS AND FUNCTIONS

L-19. Operations centers must be capable of communicating appropriately with other operations centers during incidents, including those maintained by state, local, other Service, private, and HN agencies. Communications between operations centers must be reliable and contain built-in redundancies. The efficient functioning of operations centers most frequently depends on the existence of mutual-aid

agreements and joint communications protocols among participating agencies. When incidents cross disciplinary or jurisdictional boundaries or involve complex incident management scenarios, a multiagency coordination entity (a regional operations center or installation EOC), will be used to facilitate incident management and policy coordination.

## TIERED ACTIVATION

L-20. The communication, navigation, and identification EOC, regional operations centers, and installation EOCs operate under four activations levels. Each activation level is task-organized by the type of event that the emergency management team is addressing. Although an immediate increase from Activation Level Normal/1 directly to Activation Level 4 may be warranted in many situations, some emergencies will require the capability for transitional activation moving steadily up or down the scale. Examples of such incidents include covert biological terrorism, natural epidemics, and some natural/technological hazard events (fires, volcanoes, hurricanes, winter storms). The activation levels are as follows:

- **Activation Level Normal—Normal Operations.** No emergency incident exists that is sufficient to warrant the activation of the operations center. Activation Level Normal supports FP condition normal and FP condition alpha operations, which may include support of regional/installation emergency management working group meetings, regional/installation commander briefings, and threat/AT working group meetings.
- **Activation Level 1 (Watch)—Enhanced Operations.** No emergency incident exists that is sufficient to warrant the activation of the operations center. Activation Level 1 supports FP condition alpha and FP condition bravo operations. There is no emergency management program requirement for a 24/7 watch officer during Activation Level 1. Some regions and/or installations may have additional AT program requirements based on CDR or fleet commander requirements. Typical causes for the initiation and sustainment of Activation Level 1 include terrorism threat warnings, criminal/terrorism surveillance activities, special-event planning, hurricane season/winter storm preparations, and similar events.
- **Activation Level 2 (Special)—Specialized Operations.** A unique emergency condition exists that is sufficient to warrant special activation of the operations center. Activation Level 2 supports up to FP condition charlie operations and results in increased SA. There is no emergency management program requirement for a 24/7 watch officer during Activation Level 2. Activation Level 2 simply provides additional planning and coordination support, including some specialized assistance from members of the emergency management team. Some regions and/or installations may have additional AT program requirements based on CDR or fleet commander requirements. Typical causes for the initiation and sustainment of Activation Level 2 include bomb threats, biological threat warning, preliminary laboratory results that are indicative of a potential biological incident (terrorism or natural causes), special events, active hurricane warnings/watches posted 48 to 96 hours prior to landfall, and similar events.
- **Activation Level 3 (Partial Activation)—Limited Operations.** Potential or actual emergency conditions exist that are sufficient to warrant the partial activation of the operations center. Activation Level 3 supports up to FP condition charlie operations and results in 24/7 SA, with the establishment of defined operational periods and associated reports. The primary operations center staff establishes necessary organizational sections; establishes communications with appropriate federal, state, local, other Service, and/or private, and HN counterparts; and determines the current status of emergency response and recovery resources. Typical causes for the initiation and sustainment of Activation Level 3 include evacuations involving more than 10 percent of the population, natural/technological emergencies having limited/partial impact on some or all of a population (flooding, winter storms), landfall of tropical storms, expected landfall of hurricanes (within 24-36 hours), volcano warnings, moderate- to large-scale structural fires involving multiple agencies, small-scale wildfires involving mutual-aid support, small-scale hazardous materials spills/releases involving mutual-aid or environmental-spill response, national special security events, and similar events.

- **Activation Level 4 (Full) 24/7 Operations.** Potential or actual emergency conditions exist that are sufficient to warrant the full activation of the operations center. Activation Level 4 supports up to FP condition delta operations and results in 24/7 SA, with the establishment of defined operational periods and associated reports. The emergency management team establishes organizational sections; establishes communications and initiates coordination with appropriate federal, state, local, other Service, private and HN counterparts; begins IM support, including the establishment of a joint information center; determines the current status of emergency response and recovery resources; and initiates resource management support for subordinate operations centers and the incident commander/unified command. Typical causes for the initiation and sustainment of Activation Level 4 include evacuations involving more than 50 percent of the population, earthquakes, tsunami warnings, tornados, expected landfall of hurricanes (within 24 hours or less), overt terrorism incidents, moderate- to large-scale hazardous materials spills/releases involving mutual-aid or environmental-spill response, nuclear-related events, confirmed biological incidents (terrorism or natural causes), wide-scale power blackouts, and similar events.

**This page intentionally left blank.**



## Appendix M

# Execution Activities

This appendix addresses the following execution activities:

- Assessment during execution.
- Conducting CBRN activities specific to execution.
- Integrating processes during execution.
- Making decisions during execution.

### ASSESSING DURING EXECUTION

M-1. Execution is more than putting a decision into action. It involves monitoring the situation, assessing the operation, and adjusting the order as needed.

M-2. During execution, commanders continually assess operation progress based on information from the COP and running estimates. They ensure that subordinate units execute actions appropriate to the actual situation. Assessment keeps their SA current and allows commanders to continuously update their situational understanding and validate their visualization. When the situation varies from the assumptions that the order was based on, commanders direct adjustments to exploit opportunities and counter threats.

M-3. Commanders understand, visualize, describe, direct, lead, and assess throughout the operations process, using CBRN shape and CBRN sense capabilities facilitated by linkages to the ISR process. (See figure M-1 for the commander's role in the operations process.) They develop an understanding of the OE they visualize the desired end state and develop a broad concept of how to transform the current conditions into the desired end state. Commanders describe their visualization through the commander's intent, planning guidance, and CONOPS. They also express gaps in relevant information as CCIR and essential elements of friendly information. Direction is implicit in command; commanders direct actions to achieve results and lead forces to mission accomplishment.

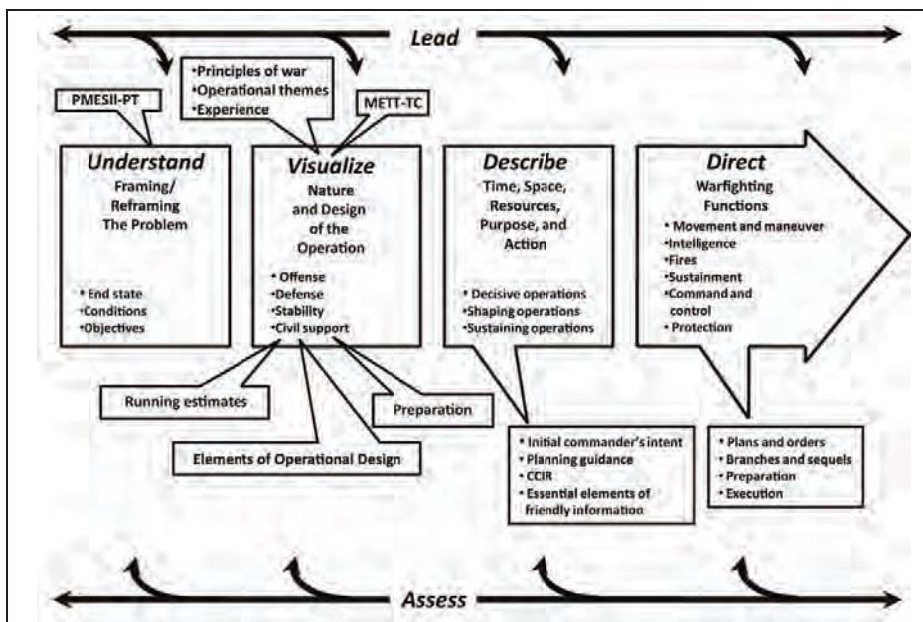

Figure M-1. Commander's role

<b>Legend:</b>	
CCIR	commander's critical information requirements
METT-TC	mission, enemy, terrain and weather, troops and support available, time available, and civil considerations
PMESII-PT	political, military, economic, social, information, infrastructure, physical environment, and time

**Figure M-1. Commander's role (continued)**

## CONDUCTING CHEMICAL, BIOLOGICAL, RADIOLOGICAL, AND NUCLEAR ACTIVITIES SPECIFIC TO EXECUTION

M-4. To execute an operation, commanders synchronize the integrating processes and continuing activities. In addition, they perform the following CBRN activities specific to execution:

- Focus CBRN assets on the decisive operation.
- Adjust CCIR based on the situation.
- Adjust control measures.
- Manage movement and positioning of supporting CBRN units.
- Adjust unit missions and CBRN-specific tasks as necessary.
- Modify the CONOPS, as required.
- Position or relocate committed, supporting, and reserve units.
- Conduct logistics recovery and rearming.

## INTEGRATING PROCESSES DURING EXECUTION

M-5. IPOE/IPB, targeting, and intelligence synchronization continue during execution. IPOE/IPB is designed to reduce the commander's uncertainties concerning weather, enemy, and terrain for a specific geographic area. It enables the commander to see the battlefield in a graphic format—where friendly and enemy forces can move, shoot, and communicate; where critical areas lie; and where friendly and enemy forces are most vulnerable. Conducting an IPOE/IPB with the intelligence staff officer is necessary to determine the most likely area for a CBRN attack and to focus CBRN assets toward that area. CBRN reconnaissance units are positioned throughout the battle zone based on the IPOE/IPB. These units provide a direct sight of defending units in battle positions. They are capable of issuing early warnings of chemical agents in the OE. The employment of CBRN reconnaissance assets provides freedom of movement by allowing the commander to reposition forces without the threat of contamination. Decontamination assets are positioned and allocated based on the IPOE/IPB. Operational decontamination is conducted in support of committed forces for the purpose of sustaining combat operations. The type, composition, and disposition of CBRN-capable units are identified in the AO and AOI, and friendly-force capabilities are identified (ranges and effectiveness of CBRN delivery systems, types of CBRN weapons available, and CBRN protective and detection equipment available). CBRN-related intelligence gaps are identified, and actions are initiated to fill them and begin new intelligence collection operations. CBRN-related gaps in priority intelligence requirements are identified and added to the collection plan. Threat models are updated with the CBRN-related data that has been collected, and threat doctrine is converted into a doctrinal template. High-value targets that may be targeted by CBRN weapons are identified.

M-6. CBRN warning and reporting is a key activity during the execution phase of the operations process. Ordinarily, JWARN automated capabilities are used to facilitate the employment of CBRN warning technologies, providing integrated collection, analysis, identification, location, reporting, and dissemination of CBRN threat information that complements decisionmaking. CBRN warning and reporting can be done manually by conducting multiple calculations/computations in support of CBRN hazard predictions, but the process is manpower-intensive, susceptible to human error, and precludes timely dissemination.

M-7. The JWARN provides the capability to rapidly receive, assimilate, and produce CBRN information that enhances the force commander's CBRN awareness of the OE and reduces the risk to friendly forces. JWARN is an integral component of the execution function because it interoperates with other battle management systems by providing additional data processing, production of plans and reports, and access to specific CBRN shape activities to improve the efficiency of limited CBRN personnel assets.

M-8. The JWARN integrates deployed CBRN sensors into an integrated detection network—a group of autonomous sensors that provide CBRN event detection (CBRN sense) by monitoring the physical parameters of a CBRN threat agent or TIM (radiation, chemical signature). Individual sensors in an integrated detection network are deployed over an AOI. This area coverage provides immediate warning to forces located within the area and supports follow-on actions to determine the actual area of contamination.

M-9. Currently, when a CBRN event occurs, the majority of CBRN agent sensors and alarms operate independently, and only those personnel in the immediate vicinity of the sensor are made aware of a warning signal. To ensure adequate FP, adjacent units also need to be notified of the hazard by radio, wire communications, or audible/verbal means.

M-10. The JWARN will enable CBRN defense specialists and other designated personnel to update the COP with CBRN- and TIM-related information. JWARN will transfer data from existing sensors and to and from future sensors, provide alerts for potential CBRN risks to commanders and units, activate alarms for personnel at risk, and send warning (and dewatering) reports to affected units throughout the OE.

M-11. JWARN operators will develop likely CBRN attack scenarios that reflect the capabilities of adversary forces. Analyzing these scenarios in JWARN as part of current-operation (near-term) planning will allow the operator to position CBRN sensors, pre-position CBRN equipment and consumables, and modify JEM templates so that high-fidelity hazard predictions better reflect the potential capabilities of adversary forces. Information from the analysis of likely CBRN scenarios will support decisionmaking at the tactical level of warfare by increasing the timeliness and accuracy of CBRN warning and reporting. (See appendix F for Service-specific applications for JWARN.)

M-12. The JEM complements JWARN during execution activities by enhancing commanders' capabilities to see first, understand first, and act first when responding to CBRN incidents and providing real-time hazard information to influence current operations. The CBRN staff uses JEM to interface and communicate with JWARN, weather systems, intelligence systems, and various databases, providing common representation of CBRN hazard areas and effects.

M-13. The JEM supports operational and crisis action planning to mitigate the effects of WMD, to include weapons with CBRN payloads and TIM releases. Additionally, JEM assists DOD components and allied or coalition forces by providing CBRN and TIM hazard predictions and effects to the warfighter during and after an incident.

M-14. Operational units will collect and report CBRN information to a CBRN cell. Through CBRN warning systems (JWARN), the CBRN cell will collect and correlate this information. The JEM will be used, automatically or manually, to calculate the transport and dispersion (the plumes of CBRN events), taking into account the terrain and weather information collected from appropriate agencies. The plumes of CBRN events will be formatted and processed by the warning system and broadcast to operational units' COP to provide a standardized picture of the effects of the CBRN hazard throughout the OE. JEM may also be operated as a stand-alone application that is not interfaced or networked with a C4I system when a network is unavailable.

## MAKING DECISIONS DURING EXECUTION

M-15. Decisionmaking continues throughout execution, but its form changes. MDMPs are not designed to address the time-sensitive decisions required to execute operations; therefore, commanders rely more on intuitive or naturalistic forms of decisionmaking than on analytic decisionmaking processes.

M-16. Commanders make two basic types of decisions during execution: execution decisions and adjustment decisions:

- **Execution decision.** An *execution decision* is the selection, during preparation and execution, of a COA anticipated by the order. (FM 6-0) The most basic form of an execution decision is applying resources or activities as outlined in the plan or within minor deviations from the plan. Commanders often delegate execution decisions to subordinates.
- **Adjustment decision.** An *adjustment decision* is the selection of a COA, during preparation and execution that modifies the order to respond to unanticipated opportunities or threats. (FM 6-0) These decisions are rarely delegated to subordinates. When commanders adjust the order, it

normally requires resynchronizing operations across the warfighting functions. Commanders may have to describe their visualization of the adjustment and provide guidance on affected control measures. Staff members take necessary actions within their areas of expertise to implement the decision.

M-17. Decisions during execution are not tied to a cycle or battle rhythm, although some parts of them may be. Being able to act when events occur, not at a predetermined point, is important for effective execution. Only in this way can commanders operate within the enemy decision cycle at a tempo that the enemy cannot match. Effective decisionmaking during execution meets the following criteria:

- It is a comprehensive, integrated combined arms process, not a series of stovepiped processes.
- It relates actions to the commander's intent and CONOPS to ensure that they support the decisive operation.
- It relies heavily on intuitive decisionmaking by commanders and staffs to make rapid adjustments.
- It is continuous and can react immediately to opportunity or CBRN threat.
- It accommodates cyclical process requirements, but is not tied to them.

# Glossary

<b>ACE</b>	aviation combat element Marine air-ground task force (MAGTF)
<b>AFCESA</b>	Air Force Civil Engineer Support Agency
<b>AFDD</b>	Air Force doctrine document
<b>AFH</b>	Air Force handbook
<b>AFI</b>	Air Force instruction
<b>AFMAN</b>	Air Force manual
<b>AFPAM</b>	Air Force pamphlet
<b>AFPD</b>	Air Force policy directive
<b>AFTTP(I)</b>	Air Force tactics, techniques, and procedures (instruction)
<b>AFVA</b>	Air Force visual aid
<b>ANG</b>	Air National Guard
<b>AO</b>	area of operations
<b>AOI</b>	area of interest
<b>AOR</b>	area of responsibility
<b>APOD</b>	aerial port of debarkation
<b>AR</b>	Army regulation
<b>ARNG</b>	Army National Guard
<b>ASCC</b>	Army service component command
<b>AT</b>	antiterrorism
<b>ATP</b>	allied tactical publication
<b>ATTN</b>	attention
<b>ATTP</b>	Army Tactics, Techniques, and Procedures
<b>C2</b>	command and control
<b>C4I</b>	command, control, communications, computers, and intelligence
<b>C4ISR</b>	command, control, communications, computers, intelligence, surveillance, and reconnaissance
<b>CB</b>	chemical and biological
<b>CBIRF</b>	chemical and biological incident response force
<b>CBR</b>	chemical, biological, and radiological
<b>CBRN</b>	chemical, biological, radiological, and nuclear
<b>CBRNC</b>	chemical, biological, radiological, and nuclear center
<b>CBRNCC</b>	chemical, biological, radiological, and nuclear control center
<b>CBRN-CE</b>	chemical, biological, radiological, and nuclear-coordination element
<b>CBRND</b>	chemical, biological, radiological, and nuclear defense
<b>CBRNE</b>	chemical, biological, radiological, nuclear, and high-yield explosives
<b>CBRNE</b>	chemical, biological, radiological, nuclear, and high-yield explosives
<b>CBRNWRS</b>	chemical, biological, radiological, and nuclear warning and reporting system
<b>CCDR</b>	combatant commander

<b>CCIR</b>	commander's critical information requirements
<b>CCMRF</b>	chemical, biological, radiological, nuclear, and high-yield explosives consequence management response force
<b>CERFP</b>	chemical, biological, radiological, nuclear, and high-yield explosives emergency response force package
<b>CFR</b>	Code of Federal Regulations
<b>CJCS</b>	Chairman of the Joint Chiefs of Staff
<b>CJCSI</b>	Chairman of the Joint Chiefs of Staff instruction
<b>CJCSM</b>	Chairman of the Joint Chiefs of Staff manual
<b>COA</b>	course of action
<b>COMDTINST</b>	Commandant, U.S. Coast Guard instruction
<b>CONOPS</b>	concept of operations
<b>CONUS</b>	continental United States
<b>COP</b>	common operational picture
<b>CRD</b>	chemical, biological, radiological, and nuclear reconnaissance detachment
<b>DA</b>	Department of the Army
<b>DC</b>	District of Columbia
<b>DOD</b>	Department of Defense
<b>DODD</b>	Department of Defense directive
<b>DODI</b>	Department of Defense instruction
<b>DSN</b>	Defense Switched Network
<b>DTRA</b>	Defense Threat Reduction Agency
<b>EEI</b>	essential elements of information
<b>EOC</b>	emergency operations center
<b>EOD</b>	explosive ordnance disposal
<b>EPA</b>	Environmental Protection Agency
<b>FBCB2</b>	Force XXI Battle Command, Brigade and Below
<b>FCM</b>	foreign consequence management
<b>FL</b>	Florida
<b>FM</b>	field manual
<b>FMI</b>	field manual, interim
<b>FP</b>	force protection
<b>G-3</b>	assistant chief of staff for operations
<b>GCCS</b>	Global Command and Control System
<b>HBCT</b>	heavy brigade combat team
<b>HN</b>	host nation
<b>HSPD</b>	Homeland Security Presidential directive
<b>HSS</b>	health service support
<b>IBCT</b>	Infantry brigade combat team
<b>IM</b>	information management
<b>IPB</b>	intelligence preparation of the battlespace

<b>IPOE</b>	intelligence preparation of the operational environment
<b>IRF</b>	initial response force
<b>ISR</b>	intelligence, surveillance, and reconnaissance
<b>JEM</b>	joint effects model
<b>JFCOM</b>	Joint Forces Command
<b>JOEF</b>	Joint Operational Effects Federation
<b>JP</b>	joint publication
<b>JPEO-CBD</b>	Joint Program Executive Officer for Chemical and Biological Defense
<b>JPM</b>	joint program manager
<b>JPM-IS</b>	Joint Program Manager for Information Systems
<b>JTF</b>	joint task force
<b>JTF-CS</b>	joint task force-combat support
<b>JWARN</b>	Joint Warning and Reporting Network
<b>MAGTF</b>	Marine air-ground task force
<b>MANSCEN</b>	U.S. Army Manuever Support Center
<b>MANSPT</b>	manuever support
<b>MCDP</b>	Marine Corps doctrine publication
<b>MCO</b>	Marine Corps order
<b>MCPP</b>	Marine Corps planning process
<b>MCRP</b>	Marine Corps reference publication
<b>MCWP</b>	Marine Corps warfighting publication
<b>MDMP</b>	military decisionmaking process
<b>METT-T</b>	mission, enemy, terrain and weather, troops and support available, and time available
<b>METT-TC</b>	mission, enemy, terrain and weather, troops and support available, time available, and civil considerations
<b>MIL-STD</b>	military standard
<b>MO</b>	Missouri
<b>MOPP</b>	mission-oriented protective posture
<b>MOS</b>	military occupational specialty
<b>MSC</b>	major subordinate command
<b>MTTP</b>	multi-Service tactics, techniques, and procedures
<b>NAI</b>	named area of interest
<b>NATO</b>	North Atlantic Treaty Organization
<b>NBC</b>	nuclear, biological, and chemical
<b>NCO</b>	noncommissioned officer
<b>NCOIC</b>	noncommissioned officer in charge
<b>NDP</b>	Navy doctrine publication
<b>NG</b>	National Guard
<b>NIOSH</b>	National Institute for Occupational Safety and Health
<b>NIPRNET</b>	Nonsecure Internet Protocol Router Network
<b>NTTP</b>	Navy tactics, techniques, and procedures



<b>OCONUS</b>	outside the continental United States
<b>OE</b>	operational environment
<b>OSHA</b>	Occupational Safety and Health Administration
<b>PDD</b>	Presidential decision directive
<b>PMESII</b>	political, military, economic, social, information, and infrastructure
<b>PMESII-PT</b>	political, military, economic, social, information, infrastructure, physical environment, and time
<b>RED HORSE</b>	squadron engineer
<b>RI</b>	Rhode Island
<b>S-2</b>	intelligence staff officer
<b>S-3</b>	operations staff officer
<b>SA</b>	situational awareness
<b>SBCT</b>	Stryker brigade combat team
<b>SIPRNET</b>	Secret Internet Protocol Router Network
<b>SME</b>	subject matter expert
<b>SOP</b>	standing operating procedure
<b>SPOD</b>	seaport of debarkation
<b>STANAG</b>	standardization agreement
<b>TIM</b>	toxic industrial material
<b>TOE</b>	table(s) of distribution and equipment
<b>TRADOC</b>	U.S. Army Training and Doctrine Command
<b>TTP</b>	tactics, techniques, and procedures
<b>U.S.</b>	United States
<b>USA</b>	U.S. Army
<b>USACBRNS</b>	U.S. Army Chemical, Biological, Radiological, and Nuclear School
<b>USAF</b>	U.S. Air Force
<b>USAMRICD</b>	U.S. Army Medical Research Institute for Chemical Defense
<b>USAMRIID</b>	U.S. Army Medical Research Institute of Infectious Diseases
<b>USC</b>	U.S. Code
<b>USCG</b>	U.S. Coast Guard
<b>USMC</b>	U.S. Marine Corps
<b>USN</b>	U.S. Navy
<b>UTC</b>	unit type code
<b>UXO</b>	unexploded ordnance
<b>VA</b>	Virginia
<b>WMD</b>	weapons of mass destruction
<b>WMD-CST</b>	weapons of mass destruction–civil support team

# References

## SOURCES USED

These are the sources quoted or paraphrased in this publication.

### ARMY PUBLICATIONS

- AR 25-30. *The Army Publishing Program*. 27 March 2006.
- FM 3-0. *Operations*. 27 February 2008.
- FM 3-05.132. *Army Special Operations Forces Chemical, Biological, Radiological, and Nuclear Operations*. 30 November 2009.
- FM 3-11.20. *Technical Escort Battalion Operations*. 29 August 2007.
- FM 3-11.22. *Weapons of Mass Destruction–Civil Support Team Operations*. 10 December 2007.
- FM 3-11.50. *Battlefield Obscuration*. 31 December 2008.
- FM 3-90.31. *Maneuver Enhancement Brigade Operations*. 26 February 2009.
- FM 4-02.1. *Army Medical Logistics*. 8 December 2009.
- FM 6-0. *Mission Command: Command and Control of Army Forces*. 11 August 2003.
- FMI 3-90.10. *Chemical, Biological, Radiological, Nuclear, and High Yield Explosives Operational Headquarters*. 24 January 2008.

### DEPARTMENT OF DEFENSE PUBLICATIONS

- DODI 6200.3. *Public Health Emergency Management Within the Department of Defense*. 5 March 2010.

### JOINT PUBLICATIONS

- JP 1-02. *Department of Defense Dictionary of Military and Associated Terms*. 12 April 2001.
- JP 3-0. *Joint Operations*. 17 September 2006.
- JP 3-06. *Joint Urban Operations*. 8 November 2009.
- JP 3-11. *Operations in Chemical, Biological, Radiological, and Nuclear (CBRN) Environments*. 26 August 2008.
- JP 3-40. *Combating Weapons of Mass Destruction*. 10 June 2009.
- JP 4-02. *Health Service Support*. 31 October 2006.
- JP 4-06. *Mortuary Affairs in Joint Operations*. 5 June 2006.

### MARINE CORPS PUBLICATIONS

- MCO 3400.3F. *Nuclear, Biological, and Chemical Defense (NBCD) Training*. 1 March 2004.
- MCO 3500.70. *Nuclear, Biological, and Chemical Defense Training and Readiness Manual*. 20 September 2004.
- MCWP 3-37. *MAGTF Nuclear, Biological, and Chemical Defense Operations*. 21 September 1998.

### MULTI-SERVICE PUBLICATIONS

- FM 1-02/MCRP 5-12A. *Operational Terms and Graphics*. 21 September 2004.
- FM 3-11.3/MCWP 3-37.2A/NTTP 3-11.25/AFTTP(I) 3-2.56. *Multiservice Tactics, Techniques, and Procedures for Chemical, Biological, Radiological, and Nuclear Contamination Avoidance*. 2 February 2006.
- FM 3-11.4/MCWP 3-37.2/NTTP 3-11.27/AFTTP (I) 3-2.46. *Multiservice Tactics, Techniques, and Procedures for Nuclear, Biological, and Chemical (NBC) Protection*. 2 June 2003.

- FM 3-11.5/MCWP 3-37.3/NTTP 3-11.26/AFTTP(I) 3-2.60. *Multiservice Tactics, Techniques, and Procedures for Chemical, Biological, Radiological, and Nuclear Decontamination*. 4 April 2006.
- FM 3-11.9/MCRP 3-37.1B/NTRP 3-11.32/AFTTP(I) 3-2.55. *Potential Military Chemical/Biological Agents and Compounds*. 10 January 2005.
- FM 3-11.19/MCWP 3-37.4/NTTP 3-11.29/AFTTP(I) 3-2.44. *Multiservice Tactics, Techniques, and Procedures for Nuclear, Biological, and Chemical Reconnaissance*. 30 July 2004.
- FM 3-11.21/MCRP 3-37.2C/NTTP 3-11.24/AFTTP(I) 3-2.37. *Multiservice Tactics, Techniques, and Procedures for Chemical, Biological, Radiological, and Nuclear Consequence Management Operations*. 1 April 2008.
- FM 3-11.34/MCWP 3-37.5/NTTP 3-11.23/AFTTP(I) 3-2.33. *Multiservice Tactics, Techniques, and Procedures for Installation CBRN Defense*. 6 November 2007.
- FM 4-02.7/MCRP 4-11.1F/NTTP 4-02.7/AFTTP 3-42.3. *Multiservice Tactics, Techniques, and Procedures for Health Service Support in a Chemical, Biological, Radiological, and Nuclear Environment*. 17 July 2009.

### NAVY PUBLICATIONS

- NTTP 3-20.31. *Surface Ship Survivability*. October 2004.

### OTHER PUBLICATIONS

- MIL-STD-2525C. *Common Warfighting Symbolology*. 17 November 2008.
- National Domestic Preparedness Office. *The Beacon*.
- National Strategy to Combat Weapons of Mass Destruction. December 2002.
- OSHA Regulation (Title 29 CFR 1910.120), *Hazardous Waste Operations and Emergency Response*.
- STANAG 2103/ATP-45(C) (Edition 9). *Reporting Nuclear Detonations, Biological and Chemical Attacks, and Predicting and Warning of Associated Hazards and Hazard Areas (Operator's Manual)*. 1 December 2005.
- STANAG 2984 (Edition 6). *Graduated Levels of Chemical, Biological, Radiological, and Nuclear Threats and Associated Protective Measures*. 8 August 2007.
- Title 10, United States Code. *Armed Forces*.
- Title 32, United States Code. *National Guard*.

### OTHER RESOURCES

- AFCEA. <<http://www.afcesa.af.mil>>.
- FEMA. <<http://www.fema.gov/about/contact/statedr.shtm>>.
- JPEO-CBD. <<http://www.jpeocbd.osd.mil/>>.
- NEHC. <<http://www.nehc.med.navy.mil/>>.
- NMRC. <<http://www.nmrc.navy.mil/>>.
- NRC. <<http://www.nrc.uscg.mil/nrchp.html>>.
- USACBRNS. <<https://www.us.army.mil/suite/>>.
- USACHPPM. <<http://chppm-www.apgea.army.mil/>>.
- USAMRICD. <<http://chemdef.apgea.army.mil/>>.
- USAMRIID. <<http://www.usamriid.army.mil/>>.

### DOCUMENTS NEEDED

These documents must be available to the intended users of this publication. DA forms are available on the Army Publishing Directorate Web site <[www.apd.army.mil](http://www.apd.army.mil)>.

- DA Form 12-99-R. *Initial Distribution Requirements for Publications (LRA)*.
- DA Form 2028. *Recommended Changes to Publications and Blank Forms*.

## READINGS RECOMMENDED

These sources contain relevant supplemental information.

### ARMY PUBLICATIONS

- DA Pamphlet 50-6. *Chemical Accident or Incident Response and Assistance (CAIRA) Operations*. 26 March 2003.
- DA Pamphlet 385-61. *Toxic Chemical Agent Safety Standards*. 17 December 2008.
- FM 3-07. *Stability Operations*. 6 October 2008.
- FM 3-13. *Information Operations: Doctrine, Tactics, Techniques, and Procedures*. 28 November 2003.
- FM 3-14. *Space Support to Army Operations*. 6 January 2010.
- FM 3-90. *Tactics*. 4 July 2001.
- FM 4-02. *Force Health Protection in a Global Environment*. 13 February 2003.
- FM 7-15. *The Army Universal Task List*. 27 February 2009.
- FM 8-42. *Combat Health Support in Stability Operations and Support Operations*. 27 October 1997.
- FM 21-10. *Field Hygiene and Sanitation*. 21 June 2000.
- FM 5-0. *The Operations Process*. 26 March 2010.
- TRADOC Pamphlet 525-66. *Force Operating Capabilities*. 7 March 2008.

### AIR FORCE PUBLICATIONS

- AFDD 1. *Air Force Basic Doctrine*. 17 November 2003.
- AFDD 2-1.8. *Counter-Chemical, Biological, Radiological, and Nuclear Operations*. 26 January 2007.
- AFDD 2-4. *Combat Support*. 23 March 2005.
- AFDD 2-4.1. *Force Protection*. 9 November 2004.
- AFDD 2-5. *Information Operations*. 11 January 2005.
- AFDD 2-8. *Command and Control*. 1 June 2007.
- AFDD 2-9.1. *Weather Operations*. 3 May 2006.
- AFDD 2-10. *Homeland Operations*. 21 March 2006.
- AFH 10-222,V3. *Civil Engineer Guide to Expeditionary Force Protection*. 1 May 2008.
- AFH 10-222,V4. *Environmental Guide for Contingency Operations*. 1 March 2007.
- AFH 10-222,V14. *Civil Engineer Guide to Fighting Positions, Shelters, Obstacles, and Revetments*. 1 August 2008.
- AFH 10-2502. *USAF Weapons of Mass Destruction (WMD) Threat Planning and Response Handbook*. 30 October 2001.
- AFI 10-245. *Antiterrorism (AT)*. 30 March 2009.
- AFI 10-2501. *Air Force Emergency Management (EM) Program Planning and Operations*. 24 January 2007.
- AFI 10-401. *Air Force Operations Planning and Execution*. 7 December 2006.
- AFI 10-402,V1. *Mobilization Planning and Personnel Readiness*. 9 August 2007.
- AFI 10-403. *Deployment Planning and Execution*. 13 January 2008.
- AFI 10-404. *Base Support and Expeditionary Site Planning*. 9 March 2004.
- AFI 31-301. *Air Base Defense*. 15 May 2002.
- AFI 32-4001. *Disaster Preparedness Planning and Operations*. 4 August 2002.
- AFI 34-242. *Mortuary Affairs Program*. 2 April 2008.
- AFI 41-106. *Unit Level Management of Medical Readiness Programs*. 14 April 2008.
- AFI 48-101. *Aerospace Medicine Operations*. 19 August 2005.

## References

---

- AFI 51-401. *Training and Reporting to Ensure Compliance with the Law of Armed Conflict*. 19 July 1994.
- AFI 51-701. *Negotiating, Concluding, Reporting, and Maintaining International Agreements*. 6 May 1994.
- AFMAN 10-100. *Airman's Manual*. 1 March 2009.
- AFMAN 10-2602. *Nuclear, Biological, Chemical, and Conventional (NBCC) Defense Operations and Standards*. 29 May 2003.
- AFMAN 32-4004. *Emergency Response Operations*. 1 December 1995.
- AFMAN 32-4005. *Personnel Protection and Attack Actions*. 30 October 2001.
- AFMAN 32-4013. *Hazardous Material Emergency Planning and Response Guide*. 1 August 1997.
- AFPAM 10-219, V2. *Civil Engineer Disaster and Attack Preparations*. 9 June 2008.
- AFPAM 10-219, V3. *Civil Engineer Disaster and Attack Recovery Procedures*. 9 June 2008.
- AFPD 10-25. *Emergency Management*. 26 September 2007.
- AFPD 10-26. *Counter-Chemical, Biological, Radiological and Nuclear Operations*. 26 September 2007.
- AFPD 51-4. *Compliance with the Law of Armed Conflict*. 26 April 1993.
- AFVA 10-2510. *U.S. Air Force Emergency Notification Signals*. 1 November 2003.
- AFVA 10-2511. *USAF Standardized Attack Warning Signals for NBCC Medium and High Threat Areas*. 24 December 2002.
- AFVA 10-2512. *Mission-Oriented Protective Postures (MOPP)*. 24 December 2002.
- AFVA 32-4022. *USAF Unexploded Ordnance (UXO) Recognition and Reporting Chart*. 1 April 1999.
- Headquarters AFCESA. *Protective Actions for a Hazardous Material Release: A USAF Protective Actions Planning Guide for Individuals and Facility Managers*. 22 October 2001.

### DEPARTMENT OF DEFENSE PUBLICATIONS

- DOD. *Protection Joint Functional Concept*. 30 June 2004.
- DOD 3150.8-M. *Nuclear Weapon Accident Response Procedures (NARP)*. 22 February 2005.
- DODD 2000.12. *DoD Antiterrorism (AT) Program*. 18 August 2003.
- DODD 2311.01E. *DoD Law of War Program*. 9 May 2006.
- DODD 3150.8. *DoD Response to Nuclear and Radiological Incidents*. 20 January 2010.
- DODD 5100.46. *Foreign Disaster Relief*. 4 December 1975.
- DODD 5240.1. *DoD Intelligence Activities*. 27 August 2007.
- DODD 5525.5. *DoD Cooperation with Civilian Law Enforcement Officials*. 15 January 1986.
- DODI 2000.16. *DoD Antiterrorism (AT) Standards*. 2 October 2006.
- DODI 2000.18. *Department of Defense Installation Chemical, Biological, Radiological, Nuclear, and High-Yield Explosive Emergency Response Guidelines*. 4 December 2002.
- DODI 2000.21. *Foreign Consequence Management (FCM)*. 10 March 2006.

### JOINT PUBLICATIONS

- CJCS. *National Military Strategy to Combat Weapons of Mass Destruction*. 13 February 2006.
- CJCSI 5120.02B. *Joint Doctrine Development System*. 4 December 2009.
- CJCSM 3150.03B. *Joint Reporting Structure Event and Incident Reports*. 28 July 2003.
- CJCSM 3500.04E. *Universal Joint Task List*. 25 August 2008.
- JP 1. *Doctrine for the Armed Forces of the United States*. 2 May 2007.
- JP 2-01.3. *Joint Intelligence Preparation of the Operational Environment*. 16 June 2009.
- JP 3-01. *Countering Air and Missile Threats*. 5 February 2007.

- JP 3-07.1. *Joint Tactics, Techniques, and Procedures for Foreign Internal Defense (FID)*. 30 April 2004.
- JP 3-08. *Interagency, Intergovernmental Organization, and Nongovernmental Organization Coordination During Joint Operations Volume I*. 17 March 2006.
- JP 3-10. *Joint Security Operations in Theater*. 3 February 2010.
- JP 3-27. *Homeland Defense*. 12 July 2007.
- JP 3-41. *Chemical, Biological, Radiological, Nuclear, and High-Yield Explosives Consequence Management*. 2 October 2006.
- JP 4-0. *Joint Logistics*. 18 July 2008.
- JP 5-0. *Joint Operation Planning*. 26 December 2006.

### MARINE CORPS PUBLICATIONS

- MCDP 1-0. *Marine Corps Operations*. 27 September 2001.
- MCO P5090.2A. *Environmental Compliance and Protection Manual*. 10 July 1998.
- MCWP 3-40.2. *Information Management*. 24 January 2002.

### MULTI-SERVICE PUBLICATIONS

- FM 3-11/MCWP 3-37.1/NWP 3-11/AFTTP(I) 3-2.42. *Multiservice Tactics, Techniques, and Procedures for Nuclear, Biological, and Chemical Defense Operations*. 10 March 2003.
- FM 3-11.86/MCWP 3-37.1C/NTTP 3-11.31/AFTTP(I) 3-2.52. *Multiservice Tactics, Techniques, and Procedures for Biological Surveillance*. 4 October 2004.
- FM 4-02.283/NTRP 4-02.21/AFMAN 44-161(I)/MCRP 4-11.1B. *Treatment of Nuclear and Radiological Casualties*. 20 December 2001.
- FM 4-02.285/MCRP 4-11.1A/NTRP 4-02.22/AFTTP(I) 3-2.69. *Multiservice Tactics, Techniques, and Procedures for Treatment of Chemical Agent Casualties and Conventional Military Chemical Injuries*. 18 September 2007.
- FM 6-40/MCWP 3-1.6.19. *Tactics, Techniques, and Procedures for Field Artillery Manual Cannon Gunnery*. 23 April 1996.
- FM 8-284/NAVMED P-5042/AFMAN(I) 44-156/MCRP 4-11.1C. *Treatment of Biological Warfare Agent Casualties*. 17 July 2000.

### NAVY PUBLICATIONS

- NDP 1. *Naval Warfare*. 28 March 1994.
- NDP 2. *Naval Intelligence*. 30 September 1994.

### OTHER PUBLICATIONS

- STANAG 2002 (Edition 10). *Warning Signs for the Marking of Nuclear, Biological, and Chemical Contaminations*. 28 March 2006.
- STANAG 2047 (Edition 7). *Emergency Alarms of Hazard or Attack (NBC and Air Attack Only)*. 24 July 1998.
- STANAG 2083 (Edition 6). *Commander's Guide on Nuclear Radiation Exposure of Groups During War*. 22 May 2003.
- STANAG 2112 (Edition 5). *Nuclear, Biological and Chemical Reconnaissance*. 12 September 2005.
- STANAG 2133 (Edition 2). *Vulnerability Analysis of Chemical and Biological Hazards*. 9 March 2004.
- STANAG 2150 (Edition 7). *NATO Standards of Proficiency in NBC Defence*. 25 October 2002.
- STANAG 2353 (Edition 5). *Evaluation of NBC Defence Capability*. 24 March 2000.



## References

---

- STANAG 2473 (Edition 2). *Commander's Guide to Radiation Exposures in Non-Article 5 Crisis Response Operations*. 6 October 2004.
- Capability Development Document (CDD) for Joint Operational Effects Federation (JOEF)*. 18 March 2005.
- Capability Production Document (CPD) for Joint Effects Model (JEM) Increment: 1 ACAT: III*. 26 October 2006.
- Capability Production Document (CPD) for Joint Warning and Reporting Network (JWARN) Increment: 1 ACAT: III*. 6 September 2007.
- COMDTINST M3120.15. *Coast Guard Incident Command System Implementation Plan*. 1 February 2001.
- Ashore AT/FP Vision Brief*. June 2005.
- CRS Report for Congress. *Terrorist Nuclear Attacks on Seaports: Threat and Response*. 24 January 2005.
- Defense Against Weapons of Mass Destruction Act of 1996* (Nunn-Lugar-Domenici Amendment to Defense Authorization Act of 1997). 1997.
- Defense Science Board. *DoD Roles and Missions in Homeland Security, Volume II—A: Supporting Reports*. May 2004.
- Department of Homeland Security. *National Incident Management System*. 18 December 2008.
- Department of Homeland Security. *National Response Framework*. 22 March 2008.
- Destruction Act of 1996 and National Defense Authorization Act Fiscal Year 1997, Public Law 104-201, Sections 1401-1455*. 23 September 1997 (U).
- Emergency Response Guidebook 2008: A Guide for First Responders During the Initial Phase of a Dangerous Goods/Hazardous Materials Incident*.
- Executive Order 12148. *Federal Emergency Management*. 20 July 1979.
- Executive Order 12656. *Assignment of Emergency Preparedness Responsibilities*. 18 November 1988.
- GAO-03-15. *Combating Terrorism: Actions Needed to Improve Force Protection for DOD Deployments through Domestic Seaports*. October 2002.
- HSPD-5. *Management of Domestic Incidents*. 28 February 2003.
- HSPD-7. *Critical Infrastructure Identification, Prioritization, and Protection*. 17 December 2003.
- HSPD-8. *National Preparedness*. 17 December 2003.
- Joint Vision 2020*. June 2000.
- Medical Management of Radiological Casualties Handbook. Second Edition*. April 2003.
- NIOSH/OSHA/USCG/EPA. *Occupational Safety and Health Guidance Manual for Hazardous Waste Site Activities*. October 1985.
- DHHS. *NIOSH Pocket Guide to Chemical Hazards*. September 2007.
- Operational Requirements Document (ORD) for Joint CBRN Warning and Reporting Network (JWARN)*. 20 May 2005.
- Operational Requirements Document (ORD) for the Joint Effects Model (JEM)*. 28 May 2004.
- PDD 39. *United States Policy on Counterterrorism*. 21 June 1995.
- PDD 62. *Protection against Unconventional Threats to the Homeland and Americans Overseas*. 22 May 1998.
- Richard R. Brennan, Jr., *Protecting the Homeland—Insights from Army Wargames*, RAND, 2002.
- Steven Lambakis, James Kiras, and Kristin Kolet, *Understanding “Asymmetric” Threats to the United States*, National Institute for Public Policy, September 2002.
- U.S. Secretary of Defense Office of Force Transformation, *Military Transformation—A Strategic Approach*. Fall 2003.



# Index

## A

adjustment decision, M-3  
agent detector, 5-5  
AO, 2-1, 2-3, 3-3, 3-4, 3-5, 3-6,  
4-2, 4-4, 5-1, 5-2, 5-4, 5-6,  
B-11, C-1, C-2, C-3, C-9, C-  
14, C-15, C-16, D-1, D-2, D-  
3, E-2, E-9, E-13, F-4, G-1,  
H-6, M-2  
AOI, D-19  
AOR, 2-2, 4-4, 5-5, C-9, D-2,  
F-3, F-8, H-5  
Armed Forces Radiobiology  
Research Institute, H-5  
assessments, 1-3, 1-4, 1-6, 2-  
1, 2-2, 2-3, 3-2, 3-3, 3-5

## B

biological agents, B-9, D-7, E-  
12, E-13, E-14, E-15, E-16,  
E-17, E-18, H-5  
biological attacks, B-9  
biological hazards, C-4, E-12  
Biological Integrated Detection  
System, C-2, C-14, I-11  
biological warfare, C-4  
biological weapons, 2-2, E-14  
blister agents, E-15, E-18  
blood agents, E-15

## C

C2, 1-1, 1-2, 1-3, 1-4, 1-6, 2-1,  
2-5, 3-6, 4-6, 5-3, 5-5, B-3,  
B-6, B-7, C-9, E-4, E-9, F-2,  
F-3, F-5, F-6, G-1, G-2, G-4,  
I-1, I-2, I-11, I-15, I-20, I-21,  
I-27, J-4, J-5, K-1, K-3, K-5  
C2 information system, 1-2  
C4ISR, F-3  
capabilities, 1-1, 1-3, 2-2, 2-3,  
2-4, 3-5, 4-3, C-2, C-6, C-9,  
C-11, D-19, H-1, H-4, J-2  
capability assessments, 1-5, 2-  
1, 2-4  
casualties, 1-4, 2-4, 3-1, 3-7, 4-  
7, 5-7, B-9, E-18, K-3, K-5,  
K-6  
casualty estimate, B-8  
CBIRF, K-3, K-4  
CBIRF capabilities, K-5  
CBRN attacks, B-11, D-4

CBRN defense capabilities, B-  
4  
CBRN hazards, 2-2, 2-4, 3-3,  
5-2, 5-6, B-5, B-11, C-3, D-1,  
D-19, E-10, F-4  
CBRN incidents, 1-2, 1-3, 1-4,  
4-2, 5-3, 5-4, 5-5, 5-6, B-7,  
C-3, C-7, D-2, D-4, D-15, F-  
4, I-28, J-2, K-10, M-3  
CBRN operations process, 1-6  
CBRN reporting, M-2  
CBRN threat assessments, D-  
14  
CBRN threats, 1-3, 2-2, 2-4, 3-  
3, 5-2, D-19  
CBRN warnings, M-2  
CBRN weapons, 2-3, D-14  
CBRNCC, B-12  
CBRNCC, F-4, K-10, K-12, K-  
13, K-14, K-15, K-18, K-19,  
K-20, K-21  
CBRN-CE, I-28  
CBRNE incidents, I-28, J-5, K-  
4  
CBRNWRS, 4-5, 5-3, 5-4, 5-5,  
5-6, B-7, B-11, C-2, I-24  
CBRNWRS capabilities, 5-5  
CCDR, 5-7  
CCIR, 1-5, 3-6, 4-2, C-13, M-1  
CCMRF, I-28  
CERFP, I-28  
chemical agents, B-9, C-3, D-7,  
D-14, E-11, E-12, E-14, E-  
15, E-18  
chemical attack, B-9  
chemical hazards, E-11  
chemical warfare, C-3, D-1, K-  
5  
choking agents, E-15  
COAs, 3-2, 3-3, 3-5, 5-2, 5-6,  
B-1, B-2, C-1, C-8, C-11, C-  
13, C-14, C-15, C-16, F-4,  
H-7  
command element, K-2, K-8,  
K-11, K-14, K-18  
commander's intent, 1-1, 1-2,  
4-6, 4-7, B-3, C-7, C-13, F-4,  
G-2, M-1  
communications, 5-3

communications capabilities,  
B-7  
concept of operations, F-2, F-3,  
F-5  
consequence management, 5-  
3, I-28, L-4  
Consequence Management  
Advisory Teams, H-5  
contaminated wastes, B-12  
CONUS, B-1, F-3, F-5, K-4  
COP, 1-1, 1-2, 3-6, 5-3, 5-4, 5-  
5, E-4, F-2, F-5, M-1, M-3  
crisis action planning, 3-5, C-1,  
F-1, F-5, M-3

## D

decontamination, 2-1, 3-4, 4-4,  
4-7, 5-2, 5-7, B-7, B-8, B-9,  
B-12, C-2, C-10, C-12, C-14,  
C-15, D-3, D-16, E-9, G-4,  
H-1, H-5, H-7, I-8, I-9, I-11, I-  
19, I-26, I-28, J-2, J-3, J-5,  
J-6, K-3, K-4, K-5, K-6, K-7,  
K-9, K-10, K-11, K-12, K-13,  
K-14, K-18, K-21, M-2  
detection capabilities, G-2  
DTRA, F-5, H-4, H-5

## E

execution decision, M-3

## F

force health protection, J-2, L-4

## G

Global Expeditionary Medical  
System, F-7

## H

health surveillance, 1-3  
health threats, 3-8, C-6, F-6, L-  
4  
HSS, vii, 3-7, 4-4, 4-7, C-6, I-  
11, I-27  
HSS assessments, C-6

## I

IM systems, F-1  
improvised explosive devices,  
C-5  
incident management, 5-3

individual protective  
equipment, 4-3, C-3, C-7, D-3, E-10

information systems, 1-2

IPB, 2-3, 3-2, 3-3, 3-6, C-9, C-12, D-3, G-4, M-2

IPOE, 2-3, 3-2, 3-3, 3-6, C-9, C-12, D-3, G-4, M-2

ISR, 1-5, 3-2, 3-3, 3-4, 3-6, 4-2, 5-1, 5-2, D-1, D-4, E-1, E-3, M-1

**J**

JEM, 3-5, F-1, F-3, F-4, F-5, M-3

Joint Acquisition CBRN  
Knowledge System, H-6

Joint Biological Point Detection  
System, B-9

joint medical analysis tool, 3-8

JPEO-CBD, H-6

JWARN, 1-3, 3-5, 3-6, 5-6, F-1, F-2, F-3

**L**

limitations, C-6

**M**

MCP, 3-2, 3-4, C-18

MDMP, 3-2, 3-4, C-18, M-3

medical surveillance, 1-3, 4-4, 4-7, B-9, C-6, F-1

**N**

National Response Center, H-3

nerve agents, E-15

nuclear blasts, E-18

nuclear detonations, E-16, E-18

nuclear devices, D-14

nuclear targeting, E-17

nuclear weapons, D-7

**O**

OCONUS, B-1, K-4

OE assessments, 1-5, 2-1, 2-3, 3-4

operational control, K-3, K-21

operations security, 4-5

**P**

passive defense capabilities, 2-1

persistent agents, D-14

personal protective equipment, 5-7, K-5

PMESII, 3-4, E-1, E-2, E-7

PMESII-PT, 1-5, 3-4, E-1, E-2, E-7

preventive medicine, J-3

priority intelligence  
requirements, 2-3, 3-3, B-6, C-13, M-2

**R**

radiological agents, D-14

radiological weapons, D-7

reconnaissance and  
surveillance capabilities, 4-2

risk assessments, 4-6, 4-7, 5-2, C-9, C-12, C-15, F-5, J-2, J-3

**S**

situational understanding, E-4

**T**

targets, 3-7

technical reachback, H-1

threat assessments, 1-4, 2-1, 2-2, 2-3, 4-2, D-4, D-7, D-16

TIMs, 2-2, 2-3, 5-3, 5-6, C-1, C-2, C-5, C-6, C-9, C-10, D-1, D-2, E-3, E-17, F-1, F-2, F-4, H-1, H-6, I-26, J-2, J-3, K-7, K-8, M-3

toxic industrial chemicals, K-5

**U**

U.S. Army Center for Health  
Promotion and Preventive  
Medicine, C-6

unintentional releases, D-13

**V**

vulnerabilities, B-9

vulnerability analysis, B-4, B-8

vulnerability assessments, 1-5, 2-1, 2-4

**W**

weather effects, E-10, E-11

WMD, 3-6, F-1, F-3, F-4, H-4, H-5, I-2, I-21, I-26, I-27

WMD-CST, I-28

ATTP 3-11.36  
MCRP 3-37B  
NTTP 3-11.34  
AFTTP(I) 3-20.70

12 July 2010

By order of the Secretary of the Army:

**GEORGE W. CASEY, JR.**  
*General, United States Army*  
*Chief of Staff*

Official:



**JOYCE E. MORROW**  
*Administrative Assistant to the*  
*Secretary of the Army*  
1019601

**DISTRIBUTION:**

*Active Army, Army National Guard/Army National Guard of the United States, and U.S. Army Reserve: To be distributed in accordance with the initial distribution number 115443, requirements for ATTP 3-11.36.*

By Order of the Secretary of the Air Force:

**JAMES F. JACKSON**  
*Brigadier General, USAF*  
*Commander*  
*Headquarters Air Force Doctrine Center*

**ACCESSIBILITY:** Publications and forms are available for downloading or ordering on the e-publishing Web site at <<http://afpubs.hq.af.mil>>.

**RELEASABILITY:** There are no releasability restrictions on this publication.

