

**MCRP 12-10A.2  
(Formerly MCRP 3-35.1B)**

---

# **Mountain Leader's Guide to Winter Operations**

---



**US Marine Corps**

---

DISTRIBUTION STATEMENT A: Approved for public release; distribution is unlimited.

**PCN 144 000116 00**

CD&I (C 116)

2 May 2016

ERRATUM

to

MCRP 3-35.1B

MOUNTAIN LEADER'S GUIDE TO WINTER OPERATIONS

1. Change all instances of MCRP 3-35.1B, *Mountain Leader's Guide to Winter Operations*, to MCRP 12-10A.2, *Mountain Leader's Guide to Winter Operations*.
2. File this transmittal sheet in the front of this publication.

PCN 144 000116 80

## To Our Readers

**Changes:** Readers of this publication are encouraged to submit suggestions and changes through the Universal Need Statement (UNS) process. The UNS submission process is delineated in Marine Corps Order 3900.15, *Marine Corps Expeditionary Force Development System*, which can be obtained from the on-line Marine Corps Publications Electronic Library:

<http://www.marines.mil/News/Publications/ELECTRONICLIBRARY.aspx>.

The UNS recommendation should include the following information:

- Location of change
  - Publication number and title
  - Current page number
  - Paragraph number (if applicable)
  - Line number
  - Figure or table number (if applicable)
- Nature of change
  - Addition/deletion of text
  - Proposed new text

**Additional copies:** If this publication is not an electronic only distribution, a printed copy may be obtained from Marine Corps Logistics Base, Albany, GA 31704-5001, by following the instructions in MCBul 5600, *Marine Corps Doctrinal Publications Status*. An electronic copy may be obtained from the United States Marine Corps Doctrine web page:

<https://www.doctrine.usmc.mil>.

**Unless otherwise stated, whenever the masculine gender is used,  
both men and women are included.**

DEPARTMENT OF THE NAVY  
HEADQUARTERS UNITED STATES MARINE CORPS  
WASHINGTON, D.C. 20380-1775

11 July 2013

FOREWORD

Marine Corps Reference Publication (MCRP) 3-35.1B, *Mountain Leader's Guide to Winter Operations*, is a reference for trained winter mountain leaders to use during operations in snow. This publication is to be used with the Marine Corps' mountain warfare and cold weather series doctrinal publications. It contains winter operations tactics, techniques, and procedures covering combat ski instruction and skills, crawls, firing positions, avalanche hazard assessment and mitigation, and crossing frozen waterways. It also covers, snow tracking and deception, skiborne patrolling considerations, and over-the-snow vehicle employment. Focusing on a standard method of instruction, this publication stresses only the cold weather skills necessary for Marines to go into combat.

Because of the rapid turnover in personnel, the many units that train annually, the multitude of training commitments, and the short winter season, the Marine Corps Mountain Warfare Training Center cannot train all scout skiers or units. Therefore, in combat, Marines may receive ski instruction from their unit's qualified winter mountain leaders.

This publication supersedes MCRP 3-35.1B, *Instructor's Guide to Combat Skiing*, dated November 1991.

Reviewed and approved this date.

BY DIRECTION OF THE COMMANDANT OF THE MARINE CORPS

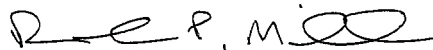

RICHARD P. MILLS  
Lieutenant General, U.S. Marine Corps  
Deputy Commandant for Combat Development and Integration

Publication Control Number: 144 000116 00

DISTRIBUTION STATEMENT A: Approved for public release; distribution is unlimited.

This Page Intentionally Left Blank

# MOUNTAIN LEADER'S GUIDE TO WINTER OPERATIONS

## TABLE OF CONTENTS

### Chapter 1. Operations in Avalanche-Prone Terrain

Data Collection and Analysis .....	1-1
Avalanche Triggers .....	1-1
Signs of Instability and Stability .....	1-1
Expedient Methods to Determine Slope Angle .....	1-2
Field Expedient Stability Tests .....	1-3
Avalanche Checklists .....	1-6
Avalanche Transceivers .....	1-7
Nomenclature and Functions .....	1-7
Wearing the Transceiver .....	1-7
Operational Test .....	1-8
Bracketing Method of Search .....	1-8

### Chapter 2. Winter Tracking

Age Determination .....	2-1
Tracking .....	2-2
Direction .....	2-2
Tracking Teams .....	2-3
Formations .....	2-4
Sign Cutting .....	2-5
Lost Spoor/Track Procedures .....	2-5
Dog Teams .....	2-6
Antitracking Techniques .....	2-6

### Chapter 3. Ice Reconnaissance

Prechecks .....	3-1
During Reconnaissance .....	3-1
Tools and Special Equipment Required .....	3-1
Ice Classification .....	3-1
Saltwater Ice .....	3-2
Freshwater Ice .....	3-2
Land Ice .....	3-2
Ice Growth .....	3-2
Blue Ice .....	3-3
Chandelier Ice .....	3-3

Rotten Ice . . . . .	3-3
Unsupported Ice . . . . .	3-3
Ice Formation Rates . . . . .	3-3

#### **Chapter 4. Military Ski Equipment**

Nomenclature of a Military Ski . . . . .	4-1
Ski Binding . . . . .	4-2
Military Ski Poles . . . . .	4-4
Care and Maintenance of the Military Ski . . . . .	4-4
Serviceability Checks . . . . .	4-4
Care of the Ski . . . . .	4-5
Maintenance of the Ski . . . . .	4-5
Ski Waxing . . . . .	4-5
Ski Waxes . . . . .	4-5
Wax and Its Effects on Snow . . . . .	4-5
Proper Selection and Application of Ski Waxes . . . . .	4-6
Wax Kit . . . . .	4-6
Climbing Skins . . . . .	4-6

#### **Chapter 5. Ski Techniques**

Falls and Injuries . . . . .	5-1
Warmup Exercises . . . . .	5-2
Ski Moves and Stances . . . . .	5-2
Basic Athletic Stance . . . . .	5-2
Telemark Position . . . . .	5-2
Star Turn . . . . .	5-3
Controlled Fall . . . . .	5-3
Recovery From a Fall . . . . .	5-3
Kick Turn . . . . .	5-4
Diagonal Stride . . . . .	5-4
Telemark Glide . . . . .	5-6
Double Poling . . . . .	5-6
Sidestep . . . . .	5-7
Forward Sidestep . . . . .	5-7
Herringbone . . . . .	5-7
Half Herringbone . . . . .	5-8
Downhill Running . . . . .	5-8
Terrain Absorption . . . . .	5-8
Uphill Traverse . . . . .	5-9
Downhill Traverse . . . . .	5-9
Uphill Diagonal Stride . . . . .	5-9
Double Pole with a Kick . . . . .	5-10
Wedge (Gliding and Braking) . . . . .	5-10
Wedge Turn . . . . .	5-11

Wedge Christie . . . . .	5-11
Wedge Telemark . . . . .	5-11
Stem Christie . . . . .	5-12
Step Turn (In Motion) . . . . .	5-12
Skate Turn . . . . .	5-13
Basic Parallel . . . . .	5-13
Dynamic Parallel . . . . .	5-13
Basic Telemark . . . . .	5-14
Stem Telemark . . . . .	5-14
Dynamic Telemark . . . . .	5-14
Telemark Turn . . . . .	5-15
Obstacle Crossing . . . . .	5-16
Free Skiing . . . . .	5-16

## **Chapter 6. Skijoring**

Safety Requirements . . . . .	6-1
Over-the-Snow Vehicle . . . . .	6-1
Techniques . . . . .	6-2
Special Considerations . . . . .	6-3

## **Chapter 7. Ice Mobility and Countermobility**

Ice Reconnaissance . . . . .	7-1
Tools and Special Equipment Required . . . . .	7-1
Information to Measure/Gather During Ice Reconnaissance . . . . .	7-1
Crossing Route Site Selection . . . . .	7-1
Fords . . . . .	7-2
Ice Breaching for Countermobility . . . . .	7-2
Ice Breaching Party . . . . .	7-3
Water Obstacle Maintenance . . . . .	7-4
Ice Ambushes . . . . .	7-4

## **Chapter 8. Over-the-Snow Casualty Evacuation**

### **Chapter 9. Over-the-Snow Vehicles**

BV-206 Small Unit Support Vehicle . . . . .	9-1
BVS-10 Viking . . . . .	9-2
Snowmobiles . . . . .	9-2

### **Chapter 10. Skiborne Firing Positions**

The Effects of Deep Snow . . . . .	10-1
Rifle Carries . . . . .	10-2
Carry 1 . . . . .	10-2
Carry 2 . . . . .	10-2



Ski Crawls . . . . .	10-2
Working Forward on Skis . . . . .	10-3
Advancing by Sliding . . . . .	10-3
Advancing in a Crouching Form . . . . .	10-3
Advancing with Trailing Skis . . . . .	10-3

## **Chapter 11. Snow Shelters**

Basic Characteristics for Shelters . . . . .	11-1
Snow Shelter Types . . . . .	11-1
Snow Wall . . . . .	11-1
Snow Cave . . . . .	11-2
Tree-Pit Snow Shelter . . . . .	11-2
Fallen Tree Bivouac . . . . .	11-3
Snow Trench . . . . .	11-3
Snow Coffin . . . . .	11-4
Construction of Snow Shelters . . . . .	11-4

## **Chapter 12. Training**

Winter Mountain Leaders (M7B) . . . . .	12-1
Scout Skiers (HB4) . . . . .	12-1

## **Appendices**

A Avalanche Decision-making Checklist . . . . .	A-1
B Avalanche Data Observation Checklist . . . . .	B-1

## **Glossary**

## **References and Related Publications**

# CHAPTER 1

## OPERATIONS IN AVALANCHE-PRONE TERRAIN

This chapter contains in depth technical information for avalanche-prone terrain, including data collection and analysis and the use of transceivers. The information discussed in this chapter directly impacts the intelligence warfighting function; for example, since entire units can be killed in an avalanche if accurate and timely information is not received and the ability to analyze tracks to determine size, direction, proficiency of enemy units will directly impact decisionmaking. Mountain leaders must combine this information with that contained in Fleet Marine Force Manual 7-29, *Mountain Operations* (currently under development as Marine Corps Warfighting Publication [MCWP] 3-35.1, *Mountain Warfare Operations*), and Marine Corps Reference Publication (MCRP) 3-35.1A, *Small Unit Leader's Guide to Cold Weather Operations*.

---

### Data Collection and Analysis

---

An avalanche is a falling mass of snow that can contain rock, soil, or ice and travels over terrain of least resistance. While operating in snow-covered mountains, avalanche threat potential must be part of the intelligence preparation of the battlespace process. Leaders assist in this process by analyzing local maps and slope angles and aspects, gathering patterns for the entire season, and conducting field data collection when possible. It is possible to travel at times of high snow instability by choosing safe routes; similarly, it is possible to be caught in an avalanche during periods of relatively low snow instability because of poor route selection and stability evaluation. A hazard potential is created by traveling in avalanche terrain; however, through careful route selection, preparation, and decision-making, the amount of danger can be limited (but

never eliminated). In order to mitigate the risk of avalanche, mountain leaders need to be able to collect and analyze pertinent data, which include trigger recognition, signs of instability and stability, field testing methods, and observation and decision-making checklist use.

### Avalanche Triggers

There are two types of triggers—natural and artificial. Natural triggers are not triggered directly by man or his equipment. Natural triggers include a falling cornice, sloughing snow, or stress change due to changes in the snowpack. Artificial triggers occur when humans or their equipment trigger avalanches, such as a passing skier, a mountaineer's weight, an explosive blast, or a sonic boom.

### Signs of Instability and Stability

To prevent Marines from creating an avalanche trigger, the mountain leader must evaluate the stability of the snow as soon as possible. An avalanche hazard evaluation is based upon a systematic decision-making process that uses signs of nature to determine the sensitivity of the snowpack. Marines may experience the following indicators of instability alone or together:

- Recent avalanche activity on similar slopes and small avalanches under foot.
- Booming or whumping, which is the audible collapse of the snow layers (normally a faceted layer).
- Visible cracks shooting out from underfoot that indicate severe tension in the snowpack.
- Sloughing debris is small-scale evidence of avalanche activity occurring. Material sliding down can leave several signs—a visible path, ripples upslope, or an accumulation pile.

- Sunballing, which is caused by rapid rewarming, creates visible lines left by snowballs rolling down the slope.
- Excessive snowfall—more than 1 inch per hour for 24 hours or more.
- Heavy rain that warms and destroys the snowpack.
- Significant wind-loading, causing leeward slopes to become overloaded.
- Long, cold, clear, calm period followed by heavy precipitation or wind-loading.
- Rapid temperature rise to near or above freezing after a long, cold period.
- Prolonged periods (more than 24 hours) of above freezing temperatures.
- Snow temperatures remaining at or below 25 °F, which slows down the settlement/strengthening process and allows unstable snow conditions to persist longer.

The following are signs of stability:

- Snow cones or settlement cones, which form around trees and other obstacles and indicate the snow around the object is settling.
- Creep and glide. Creep is the internal deformation of the snowpack. Glide is slippage of the snow layer with respect to the ground. Evidence of these two properties on the snowpack is a ripple effect at the bottom of a slope. It is an indication that the snow is gaining equilibrium and strength through this type of settlement process. See figure 1-1.
- Absence of wind during storms, which is indicated by snow accumulation in the trees.
- Snow temperatures remaining between 25°F and 32°F, which ordinarily settles the snow rapidly and causes snow to become denser and stronger because of the effects of rounding.

### Expedient Methods to Determine Slope Angle

Slope angle is the most important variable in determining the possibility that a given slope will avalanche. Methods that can be used to determine slope angle are the inclinometer and protractor.

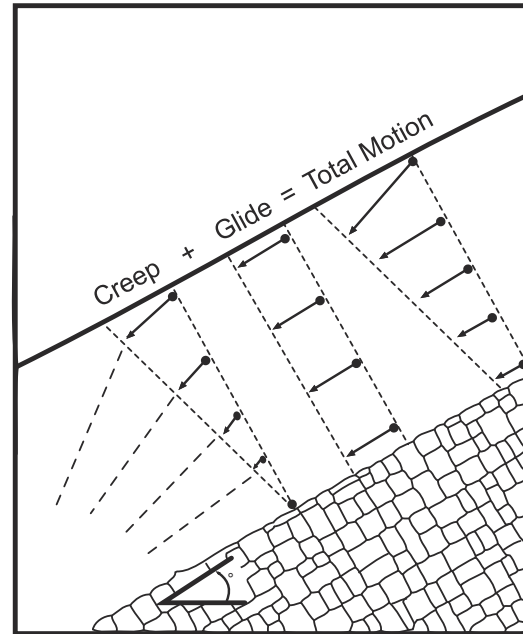

Figure 1-1. Creep and Glide.

### Inclinometer Method

Inclinometers are designed to get an approximate reading of a slope angle in degrees. They may be a part of a compass or a separate piece of equipment. To use an inclinometer, Marines must—

- Place a ski pole on a slope, ensuring that the pole is flush with the surface.
- Place the inclinometer on the ski pole. The dial will indicate the angle of the slope.

### Protractor Method

To use a standard-issued protractor to determine slope, it must be modified with a 12-inch string in its center and a weight placed on the end of the string. To use this method, Marines must—

- Dig a small hole into a slope.
- Place a ski pole on the slope, ensuring that the pole is flush with the surface and that it is aligned over the hole.
- Place the protractor on the ski pole with 0° down and 90° facing down the slope.
- Read the azimuth degree scale where the string intersects it, which indicates the angle of the slope. See figure 1-2.

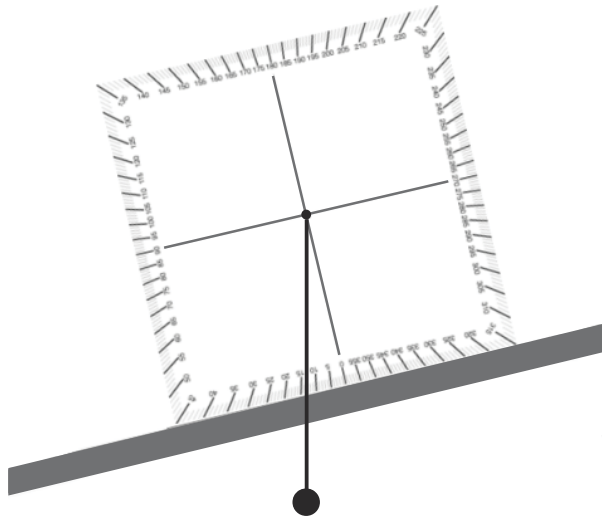

**Figure 1-2. Protractor Method.**

### Field Expedient Stability Tests

Often, no single field test or observation provides all the required information. A mountain leader must gather all available information about the snowpack in order to make a complete analysis. Usually, the various pieces of information back each other up and tell the same story. Field expedient stability tests are a good place to start gathering information, but they should be conducted on short slopes where no serious consequences would result. The following six tests are used to gather field expedient snow stability information.

#### **Testing Small Steep Hills**

Small, steep slopes can provide a Marine with valuable information. To test the slope, the Marine jumps from the top on to the slope and notes how the slope responds.

#### **Test Skiing**

Test skiing is a stability test during which a skier adds stress to the snow with his weight and/or by jumping and kicking. The tester can immediately observe the depth and type of the weak layer that might have failed. While traversing uphill on skis and having just turned a corner, he jumps just below the uphill ski track to see if any uphill

snow breaks off in blocks. Breakage indicates that the snow may fracture (see fig. 1-3).

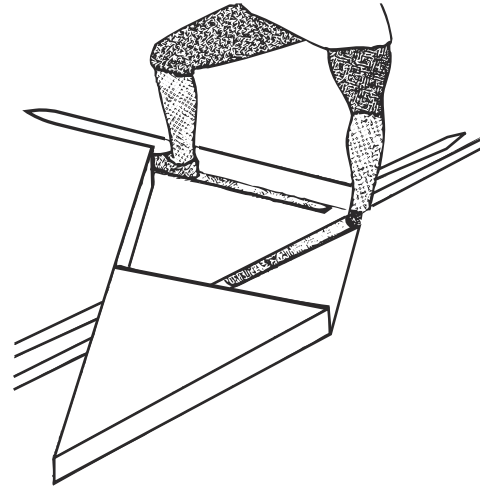

**Figure 1-3. Example of a Ski Test for Stability.**

#### **Ski Pole Test**

The ski pole test determines the depth and distribution of potential slabs. This test takes only seconds and should be done while traveling. To perform the ski pole test, Marines must—

- Hold the ski pole at a right angle to the snow surface, then gently push the pole into the snowpack.
- Feel for the relative hardness and the thickness of the layers.
- Be alert for well-consolidated layers that feel harder than underlying soft, weaker layers.

See figure 1-4 on page 1-4. If the basket of the ski pole interferes with probing, the handle of the ski pole can be used to probe instead.

*Note: One serious limitation of the ski pole test is that sometimes the weak layers are too thin to detect. The test does not detect how well the layers are bonding together.*

#### **Shear Tests**

The principle objective of a shear test is to locate weak layers and interfaces. There are many

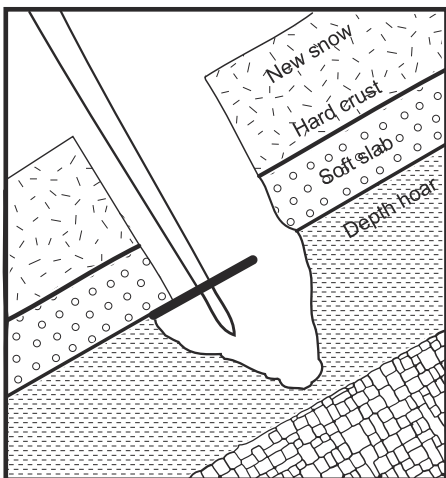

**Figure 1-4. Ski Pole Test.**

different types of shear tests, but the two types Marines use are the rutschblock and shovel/ski shear tests.

The rutschblock test involves several steps. To construct the rutschblock, Marines must—

- Select a site on a slope with the same slope angle and aspect as the slope the unit intends to cross. Personnel conducting the test may be belayed.
- Begin digging a pit approximately one ski length wide and at least 5 feet deep (1.5 m).
- From the ends of the pit, dig two narrow trenches uphill into the slope approximately

the length of one ski pole. Ensure that the depths of the trenches are the same as the pit's depth.

- Being very careful not to disturb the area of the rutschblock, use a snow saw or a knotted length of cordage and cut the back of the wall to isolate the snow block (see fig. 1-5).
- Carefully ski to the side of the test site and approach the upper cut of the rectangular block diagonally from above. Once the skis are perpendicular to the cut on the uphill side, gently move on to the block. Stability is determined at the point when the block fails (see table 1-1).

The shovel/ski shear test is a method of obtaining information on where weak layers are suspected without a lot of digging. To construct a shear pit, Marines must—

- Isolate a column in the uphill pit wall by cutting away the sides with a shovel or ski. The width of this column and the depth cut into the pit should be approximately 12 inches (30.5 cm). The column must be both vertical and smooth (see fig. 1-6).
- Insert a shovel/ski behind the column and exert steady pressure while pushing down. Look for possible separation of the weak layers (see fig. 1-7).

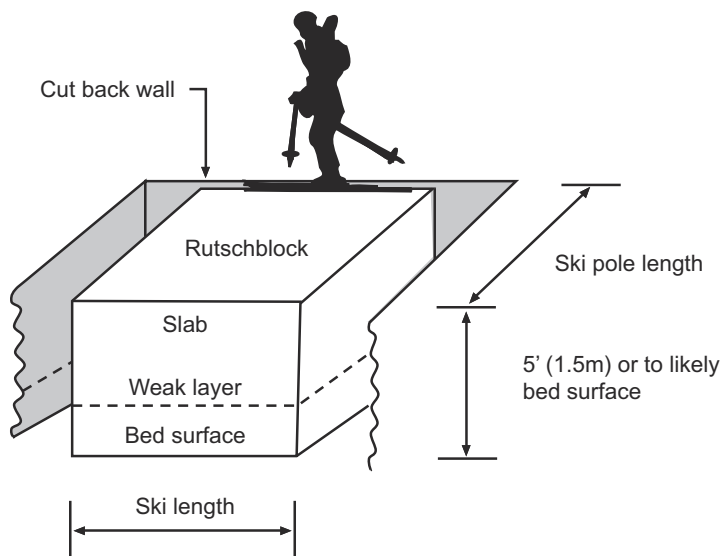

**Figure 1-5. Rutschblock Test.**

**Table 1-1. Rutschblock Test Sequence.**

STEP	REACTION	RESULT
1	Fails while excavating test site	Extremely unstable
2	Fails while approaching test site	Extremely unstable
3	Fails while standing on shear block	Extremely unstable
4	Fails while flexing knees	Unstable
5	Fails with one jump while wearing skis	Unstable
6	Fails after repeated jumps with skis on	Relatively stable
7	Doesn't fail after repeated jumps with skis off	Stable or very stable

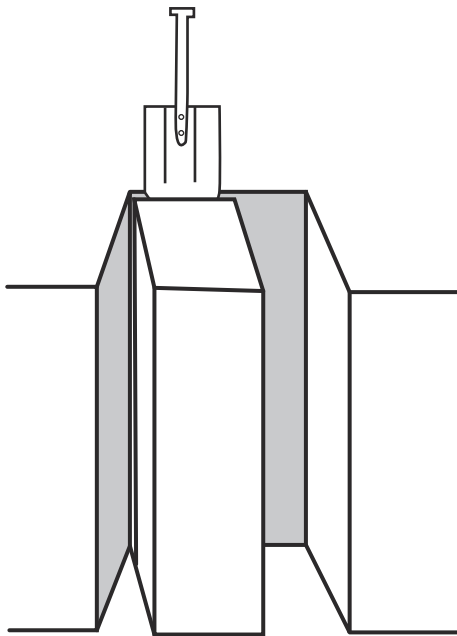
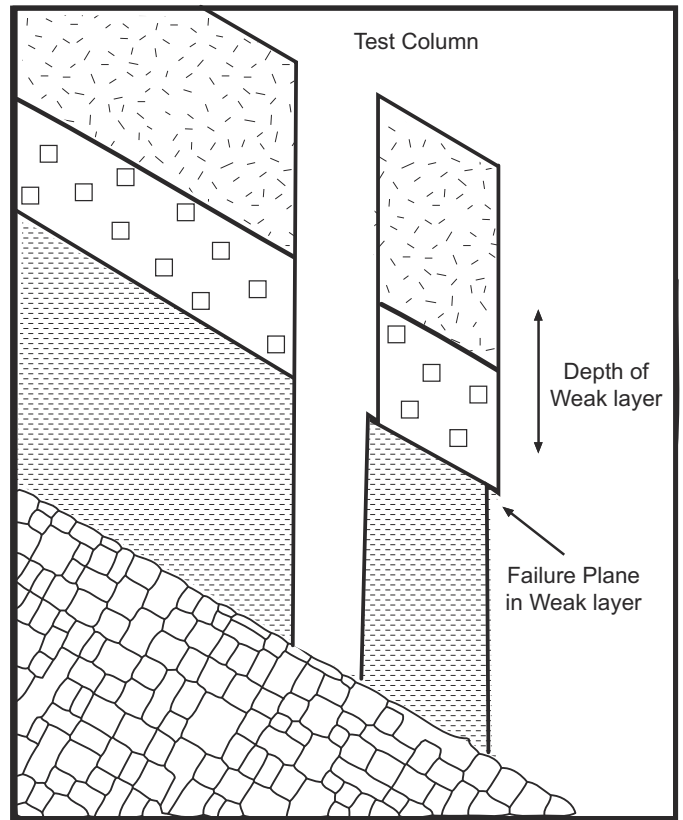

**Figure 1-6. Shovel Shear Test.**

**Shred Block Test**

The shred block test is like a rutschblock, but uses snowshoes instead of skis. To perform this test, Marines must—

- Dig the shred block. See figure 1-8 on page 1-6. Dimensions of the shred block will be a column approximately 1.75 meters wide (across the fall line), 1.5 meters on each side (up the fall line), and somewhat deeper than the suspected failure layer (to a maximum of about 1.5 meters),



**Figure 1-7. Weak Layer Giving in a Shovel Shear Test.**

which requires excavating a significant amount of snow. Dimensions will vary slightly, depending on what method is used to cut the sides of the block.

- Conduct the test same as the rutschblock, wearing snowshoes instead of skis.

**Snow Pit Analysis**

Snow pit analysis is a method of analyzing the snowpack for instabilities by identifying weak layers. Snow pit analysis can be extremely complex, but mountain leaders must only make the basic observations. To construct the snow pit, Marines must—

- Choose a location with the conditions similar to those Marines are trying to evaluate, such as elevation, snow condition, slope angle, and slope aspect.

- Dig a pit five feet deep and wide enough to work in. Be careful not to disturb the snow surface surrounding the uphill portion of the pit.
- With a shovel, smooth off the uphill pit wall and adjacent (side) wall. Ideally, the adjacent wall should be shaded; the tests will be conducted on them. It is important that they are smooth and vertical and that the snow above the uphill wall remains undisturbed.

To identify layers, perform the following tests in the snow pit:

- *Stratigraphy test.* Using a whiskbroom, paint brush, hat, or mitten, lightly brush the sidewall of the pit with uniform strokes parallel to the snow surface, which quickly transforms the wall from a plain white surface into a layered mosaic of snow history. The raised or ridged surfaces indicate the harder, stronger layers that may be possible slabs or sliding surfaces. The indented surfaces reveal softer, weaker layers.
- *Resistance test.* Insert a credit card, saw, or any straight edge into the top of the sidewall and run the card down the wall, feeling the relative resistance of the layers and noting the boundaries of hard and soft layers. In helping to identify potential slab and weak layers, this test can help

corroborate and expand upon the information gained from the stratigraphy test. See figure 1-9.

- *Hardness test.* Marines test the relative hardness of each layer by gently pushing a hand or fingers into the pit wall, applying approximately 10 pounds of pressure. One layer might be so soft that one can easily push the whole fist into it, while another might require a knife to penetrate it. An example of a potential unstable slab configuration would be a cohesive one-finger hard layer resting on top of a less cohesive fist hard layer (see table 1-2).

### Avalanche Checklists

The checklist consists of two different checklist tools—the decision-making checklist, which rates hazard low to extreme (see app. A), and the data observation checklist, which rates hazard by *GO/NO GO* levels (see app. B). Using both checklists will give the most accurate avalanche hazard assessment when moving the unit through a snow-covered battlefield. The tactical situation will affect the determination of a *GO/NO GO* hazard level. See MCRP 3-35.1A for ways commanders can mitigate avalanche risk. These checklist blanks can be laminated back-to-back for field use.

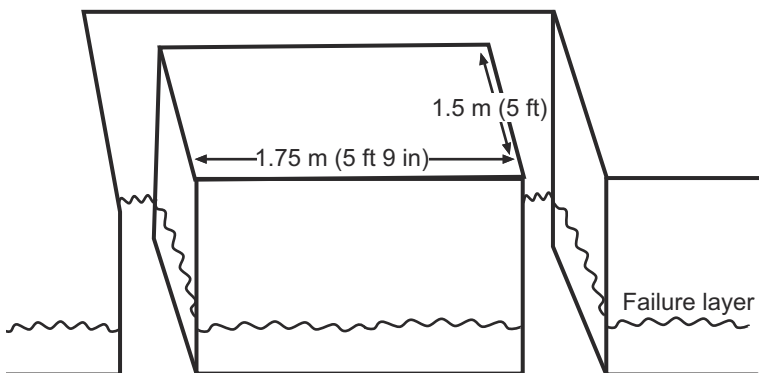

Figure 1-8. Shred Block Using Snowshoes.

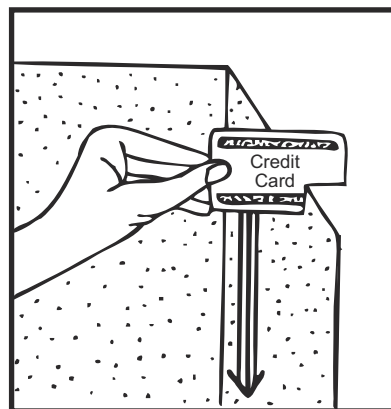



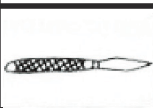

Figure 1-9. Resistance Test.

**Table 1-2. Hardness Test.**

Very soft	Fist (F)	
Soft	Four fingers (4F)	
Medium	One finger (1F)	
Hard	Pencil (P)	
Very hard	Knife (K)	

## Avalanche Transceivers

Transceivers (rescue beacons) are electronic devices that can transmit and receive radio signals. The 457-kilohertz radio frequency is now standard, but numerous older units with a 2.275-kilohertz frequency and units that operate on both 457 and 2.275 kilohertz are still in use. Leaders must ensure that all members of the patrol carry transceivers that are compatible with each other.

### Nomenclature and Functions

Transceivers have the following features:

- *On/off plug.* To turn the transceiver on, Marines must insert the cross plug into the designated socket and lock it into place by gently pushing the cross plug inward while turning 90°. The procedure is reversed when turning the transceiver off.
- *Earphone jack.* This jack is the socket where an earphone can be attached.
- *Battery compartment.* Two AA (1.5 volt) premium quality alkaline batteries are used in this compartment. Rechargeable batteries should not be used.

- *Battery light emitting diode.* This indicator shows the amount of battery power available.
- *Transmit/receive switch with safety catch.* The switch is pushed in to transmit or pulled out to receive. The safety catch must be in place during the transit mode to prevent accidental employment of the receiving mode. See figure 1-10.
- *Range dial.* This dial controls the volume of the signal.
- *Signal strength indicator light emitting diode.* This indicator shows the strength of the signal being received and is accurate to within 50 centimeters.
- *Search direction arrow.* This arrow indicates the direction the transceiver needs to be oriented during the search.
- *Casing.* The casing is made of watertight and shockproof plastic.
- *Straps.* Nylon webbing adjustable straps with a plastic buckle are used to secure the transceiver around the body, under outer garments.

### Wearing the Transceiver

To wear the transceiver, Marines must—

- Place the strap with the cross plug around the neck or around the neck and shoulder.

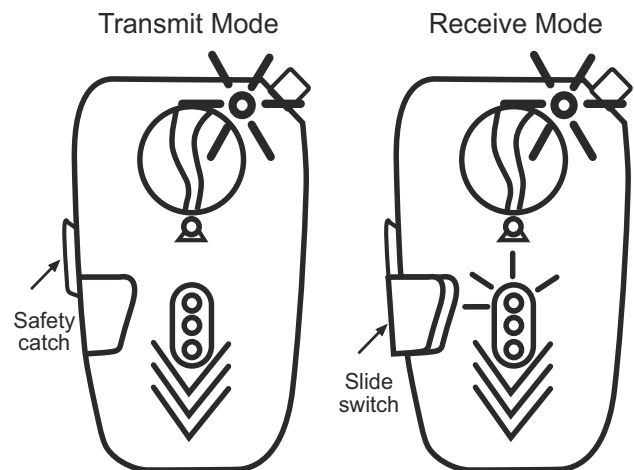
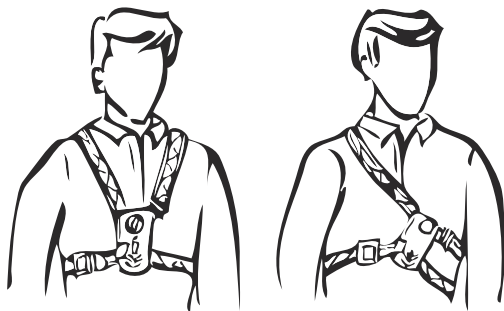

**Figure 1-10. Transceiver in Transmit and Receive Modes.**



- Insert cross plug into the case to activate the transceiver.
- Adjust the strap to a comfortable position, run the second strap around the torso, and secure the plastic buckle. See figure 1-11.
- Check the transmit/receive switch to ensure that it is in the transmit mode.

*Note: The transceiver should always be worn under outer clothing and as close to the body as possible.*



**Figure 1-11. Wearing the Transceiver.**

### Operational Test

Before a patrol deploys from a safe area, the transceivers must be checked to ensure that all the transceivers are operable. The patrol leader should perform the following test:

- The leader will set his transceiver to the transmit mode while all other members set their transceivers to the receive mode.
- The leader will walk away from the patrol to a point where the patrol member's transceivers are no longer picking up the patrol leader's signal to ensure that all the patrol member's transceivers are receiving and that the patrol leader's transceiver is transmitting.
- The leader will then set his transceiver to the receive mode while all the patrol members set their transceivers to the transmit mode.
- One at a time, the patrol members will file past the leader. The leader will ensure that each patrol member's transceiver is transmitting properly.

- After each member has been checked, the leader will set his transceiver back to the transmit mode.

### Bracketing Method of Search

There are numerous methods of searching for victims. The bracketing method provides speed and accuracy when conducted properly. To conduct this type of search, Marines must—

- Note and mark last seen point of the victim carefully. If there is further danger of avalanches, post an avalanche guard who should be prepared to switch back to transmit.
- Set all the transceivers to the receive mode. The leader must ensure his Marines' transceivers are set to receive so as to prevent any misleading transmissions from other transceivers.
- Turn the range dial to its highest range indicator/volume.
- Deploy a line of searchers at a maximum of 20 meters apart to the last seen area and move down the slope. See figure 1-12.
- Slowly rotate the transceiver 120 degrees from side to side to determine direction of strongest signal. See figure 1-13.
- Mark the spot where the first signal was received and proceed in a straight line. The signal will get stronger then weaker.
- Mark the weakest point.

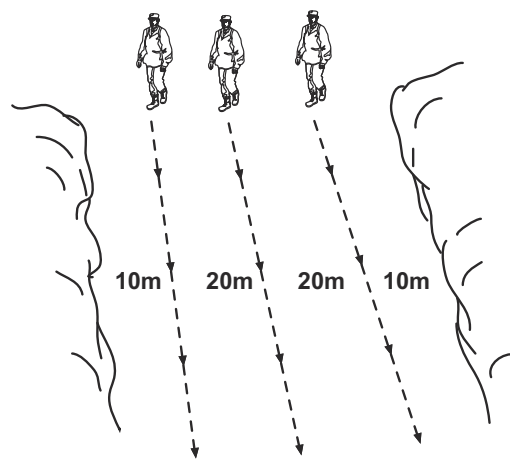
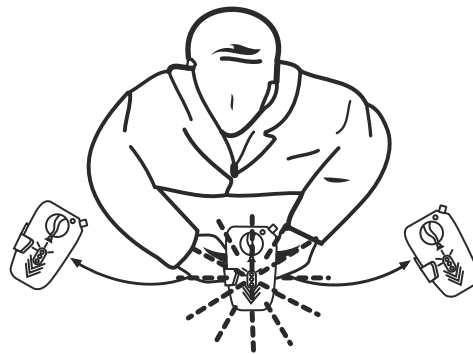

**Figure 1-12. Conducting a Bracketing Search.**

- Find the middle of the two weak points and mark this spot. Turn the range dial/volume down so that the signal is low.
- Proceed in a direction 90 degrees to the first line. In one direction the signal will get weaker, in the opposite direction the signal will get stronger. Move in the direction of the stronger signal.
- Proceed past the strong signal until it becomes weaker, mark this weak spot. Remember to

- turn down the range dial/volume each time a new line of travel is taken.
- Repeat this process until the exact location is found and begin probing and/or digging. See figure 1-14.

*Note: After the search and recovery is completed, all transceivers must be set back to the transmit mode. See MCRP 3-35.1A for information on organizing a company-sized avalanche search.*



**Figure 1-13. Rotating the Transceiver.**

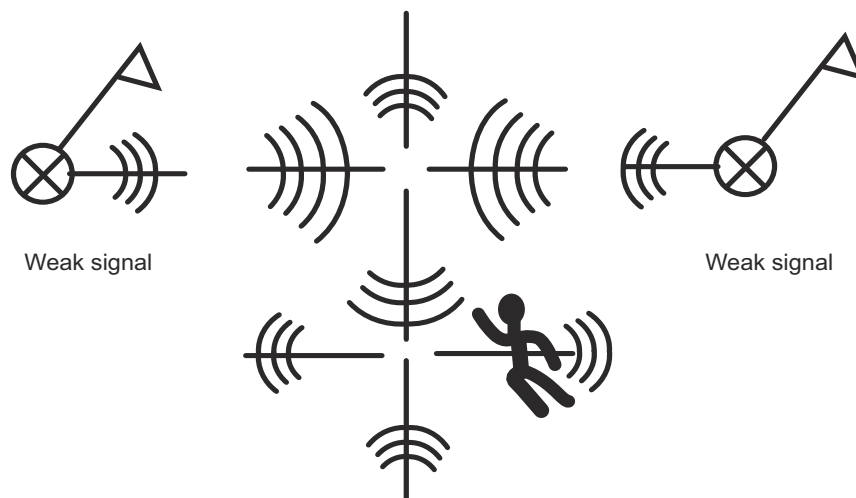

**Figure 1-14. Pinpointing Location.**

This Page Intentionally Left Blank

# CHAPTER 2

## WINTER TRACKING

In snow-covered terrain, tracking can be very effective. The size of the unit, direction of travel, and time of travel can all be determined from tracks in snow. On the other hand, countertracking is also a skill Marines will need when moving in snow-covered terrain to prevent compromise or to deceive the enemy.

Basic terms unique to tracking in snow include—

- *Transference*. Transference is the removal of material from one area onto another. Transference can occur when walking along a muddy stream bank and then crossing a log. The mud left on the log is considered transference.
- *Compression*. Compression is the actual flattening of the soil or snowpack. It is caused by the pressing down or leveling of soil, sand, stones, twigs, or leaves by the weight of the body. Compression is more likely to be found in frozen, hard, dry, and sandy conditions where there is no moisture to hold a clear and lasting imprint.
- *Disturbance*. Disturbance is the eye-catching effect of unnatural patterns, which is very common in a snow-covered environment. Examples include—
  - ◆ *Shoveling snow*. The initial tossed snow is transference. Once it melts, it will disturb the top layer of the snowpack, leaving an unnatural pattern.
  - ◆ *Forward movement*. All forward movement by man or animal will kick snow forward. The initial tossed snow is transference, but it becomes disturbance once the snow has melted.
- *Sign*. A sign is any disturbance of the natural condition, which reveals the presence or passage of animals, persons, or things. Examples

of signs include stones that have been knocked out of their original position, overturned leaves showing a darker underside, sand deposited on rocks, drag and scuff marks, displaced twigs, and scuff marks on trees.

- *Spoor*. Spoor is the actual track or trail of a man or animal, which can identify its size, shape, type, and pattern. This word is generally interchanged with track. Spoor can be either aerial or ground.

---

### Age Determination

---

It is critical to be able to determine track age. Each area and climate will vary in the effects of aging tracks, so practice, experimentation, and experience is vital in that area. The following factors lead to deterioration of tracks:

- *Weather*. The last snow, rain, fog, melt-freeze cycle, and dew all affect deterioration rates.
- *Sun*. Latitude, cloud cover, and slope aspect/angle to the sun affect deterioration rates.
- *Wind*. Strength and direction of wind impact deterioration. Also, the windward side of the mountain erodes tracks while the leeward side buries tracks.
- *Surface content*. Whether the surface is hard, sandy, firm, or moist soil or it is covered with frozen, hard, or loose snow will impact the rate of deterioration.
- *Track erosion*. All tracks will erode over a given period. The key to snow track erosion is the amount of sunlight and temperature to which the track has been exposed. Table 2-1 on page 2-2 can be used as a general guideline.

**Table 2-1. Track Erosion Timetable.**

Time	Track Erosion
Minutes to 1 hour	Transference is noticed around the outer edges on top of the snowpack Track edges are sharp and clean
1 to 3 hours	Transferred snow has melted, leaving small pockmarks on top of the snow Track edges are slightly rounded
4 to 24 hours	Pockmarks on top of snowpack have disappeared Track edges are rounded, inside track walls are firm
24 to 72 hours	Top layer of snowpack is angling down toward the track Track is beginning to fill in and will have an "S" curve

## Tracking

Tracking is a critical skill while operating in mountains. The following techniques and procedures produce effective results:

- The best time to track is early in the morning or late in the afternoon due to the height of the sun to cast shadows.
- When reading spoor, the tracker must always place himself between it and the sun.
- Trackers should not move past the last sign until the next sign has been found, which is known as "sign cutting."

- Once the initial track is found, trackers must completely document and sketch it for future reference. This sketch will prevent Marines from following the wrong track later on.

## Direction

Determining the direction of the pursued is generally not a problem with animals; however, man's over-the-snow equipment may confuse a tracker. All forward movement will displace snow forward, referred to as "fluffing." Fluffing is the key to successful tracking. As snow begins to melt, pockmarks will be left on the level snowpack (see fig. 2-1).

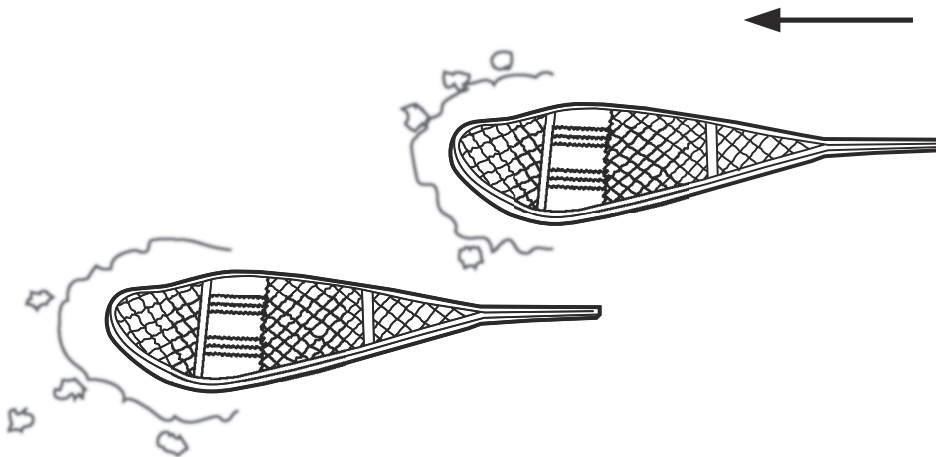

**Figure 2-1. Fluffing.**

Inexperienced personnel may believe that walking backwards in snowshoes will fool a tracker, but it will not confuse an experienced tracker. This type of activity is extremely exhausting and some fluffing still occurs (see fig. 2-2).

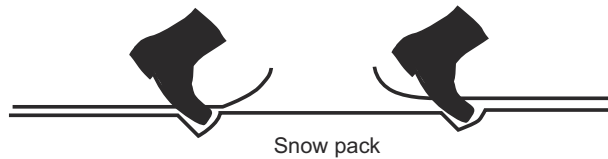

**Figure 2-2. Walking Backwards in Snowshoes.**

Skiers can also be tracked and their direction determined. As the ski pole is planted and the ski moves forward, the basket will also angle forward. The basket digs into the snow, leaving an indent on the forward edge indicating direction. The point of the ski pole will also contact the snow before the pole is planted, making a line pointing away from the direction (see fig. 2-3).

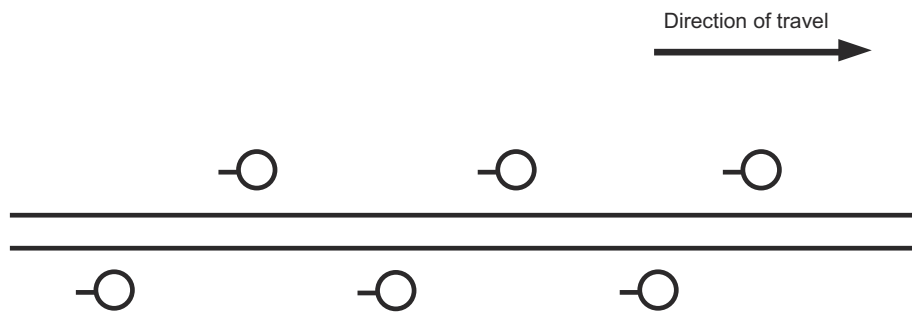

**Figure 2-3. Skiing Direction.**

Direction is difficult to determine with snowmobiles and tracked vehicles. The tracks will compress snow inside the track, forming plates. These plates are the keys to determining direction. At ground level, most plates will face the direction of travel, although a small number will face in the opposite direction (see fig. 2-4).

**Tracking Teams**

If tracking teams are available, sign cutting can speed up the tracking process. All of the tracking teams (minimum of two) must document and sketch the initial track. The advantages of tracking teams include—

- Locating other members of the team if they become separated.
- Assisting dog handlers to find a track if the dog loses the trail.
- Giving a verbal account of the track picture over the radio.

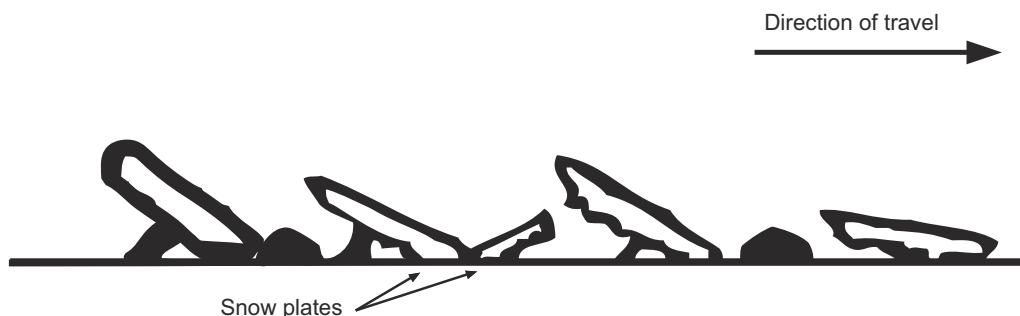

**Figure 2-4. Determining Tracked Vehicle Direction.**

The disadvantages of tracking teams include—

- Normally slower than dogs.
- Must always use their powers of observation.
- Limited use during the hours of darkness.

## Formations

Several formations may be used for tracking—

- *“Y” formation.* This very flexible formation is the basis for all other formations and immediate action drills. Best used in open to fairly open country, the distance between trackers depends on visual contact with the controller and will vary according to terrain and vegetation conditions. See figure 2-5.

- *Half “Y” formation.* This formation is used when ground or vegetation conditions are such that the flank tracker cannot keep up with the speed of the follow-up. Although he is now positioned to the rear of the controller, he is still responsible for observing his zone of responsibility. See figure 2-6.
- *Single file formation.* This formation is used when the terrain or vegetation is such that both flank trackers cannot keep up with the pace of the tracker. Generally, it is used in thick brush conditions where visibility is restricted. See figure 2-7.
- *Extended line formation.* This formation is used when there is little vegetation to restrict visibility and the spoor is difficult to see. Using three trackers simultaneously speeds up the follow-up and maintains momentum. See figure 2-8.

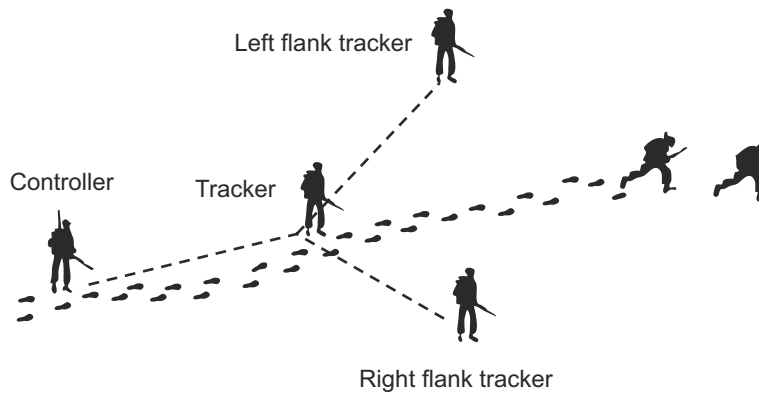

**Figure 2-5. “Y” Formation.**

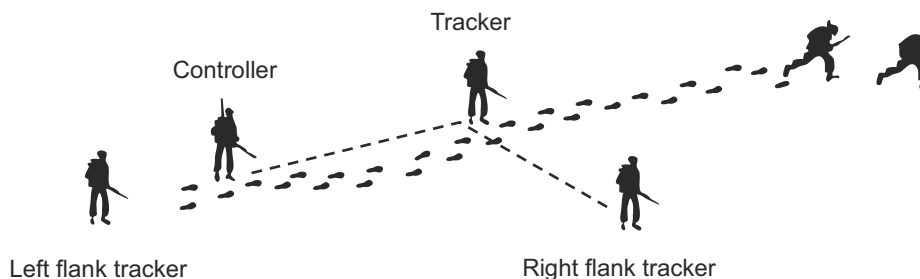

**Figure 2-6. Half “Y” Formation.**

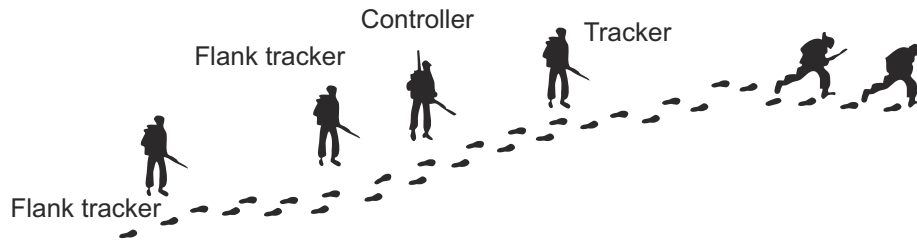

**Figure 2-7. Single File Formation.**

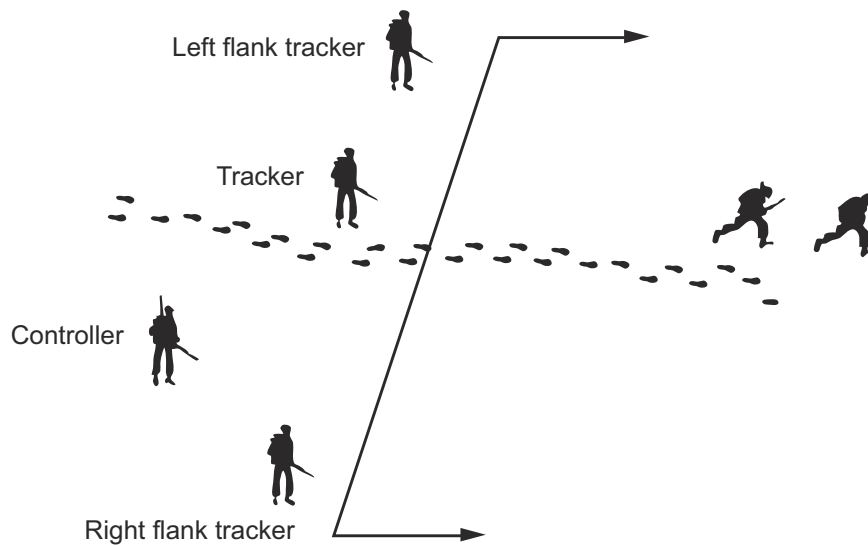

**Figure 2-8. Extended Line Formation.**

**Sign Cutting**

Sign cutting is the process of two tracking teams criss-crossing in arcs to intersect the track. The initial team that finds the track continues to track until another tracking team has positively found the same track further ahead on the trail. The last track is marked for future reference. The second team then assumes the responsibility of locating each track until they have been radioed by the first team that they have found the track. Increased distance can be overcome by sign cutting/leap frogging.

**Lost Spoor/Track Procedures**

If a track is lost by a tracking team that is operating alone, the team uses the following (in order of presentation) lost spoor procedures:

- Search the most likely lines of advance.
- If not successful, search in a 360-degree pattern, starting behind the controller.
- If still unsuccessful, widen the 360 and search again.
- If that fails, proceed with an extended line search from the last known point.



## Dog Teams

The advantages of dog teams are that dogs—

- Cause fear in the pursued.
- Track faster and are more aggressive on a hot track.
- Are very good at picking up the initial trail and direction.
- Can track over terrain that has little or no visual sign.
- Can track at night.
- Will alert trackers when the enemy is near.

The disadvantages of dog teams are that dogs—

- May stray off track when tired.
- Cannot work long tracks under difficult conditions.
- May track for or stop at water.
- Are only as good as the handler's physical condition and abilities.

---

## Antitracking Techniques

---

There are four methods that the enemy may use to track Marines—

- Direct observation.
- Detection equipment, such as thermal imaging, active infrared (night vision goggles), acoustic detectors/sensors, and/or direction-finding equipment for radios.
- Search teams, which may be military, civilian, and/or trained trackers.
- Dogs, which may be attack or tracking dogs. It is difficult to determine if Marines are being tracked by dogs.

There are several techniques that Marines can use to defeat the enemy's ability to track them; however, Marines must remember that the enemy may also use antitracking techniques. A variety of antitracking techniques can be employed with respect to time and terrain. More than one technique can

be employed at a time. The following are antitracking techniques for units or individuals:

- Brushing out tracks.
- Restoring vegetation.
- Using hard, stony ground.
- Changing direction abruptly.
- Traveling on well-used paths.
- Wearing custom footwear, so tracks appear as the local population or enemy military.
- Using foot coverings to mask tread pattern/imprint.
- Walking backwards.
- Confusing the start point or track by tracking up with multiple tracks in various directions. Crossing or moving in streams, lakes, or waterways. Changing footwear.
- Crossing roads/paths with traffic pattern.
- Using daily traffic to hide or destroy spoor.
- Carefully placing footfalls on ground, leaving little heel or toe dig.

The following techniques may be used by units to reduce or hide tracks:

- Calling in fire to destroy a section of tracks, also called bomb-shelling.
- Splitting up in break-away groups, so not all tracks can be followed.
- Being dropped off by ground, water, or air transportation, which creates gaps in the track. This technique can be used for legs within a movement, not just the start point.

If Marines are being tracked, the primary concern is to gain as much distance between them and the tracker. Increasing the distance between Marines and the trackers is best accomplished by using antitracking/spoor reduction techniques.

*Note: Running is the worst method for increasing the time-distance gap (with exceptions).*

Creating distance also creates additional time, allowing Marines to develop and use more

antitracking techniques. The following are delaying techniques:

- *Creating simple path guards along the trail.* An experienced tracker will not pick up things along the trail because of the possibility that they are boobytrapped. If he notices possible traps, he will use more caution and slow his pace.
- *Using caution when moving along the trail.* When traveling, Marines can make it difficult for the tracker to find their tracks. Although this is difficult in snow, staying in the tree line will reduce the possibility of being discovered

by aircraft; however, Marines should avoid brushing up against snow-covered saplings and large branches and knocking the snow off the branches. Exposing the green foliage draws immediate attention to the area.

- *Backfilling all tracks leading toward the bivouac.* When in a small unit or when the tactical situation dictates, backfill the jump off point with snow from the bivouac site, completely filling in all holes from the main track until no longer seen. Make sure that the filler snow is completely blended in with the top layer of the snowpack.

This Page Intentionally Left Blank

# CHAPTER 3

## ICE RECONNAISSANCE

Reconnaissance of a frozen waterway prior to crossing is necessary to determine the load bearing capacity of the ice. The thickness of the ice dictates what can cross and at what dispersion to mitigate risk. Therefore, the thickness of the ice must be determined at the crossing point and periodically along the route if using the frozen waterway itself as a road.

---

### Prechecks

---

Prior to cutting the ice to determine thickness, Marines should check for the following to ensure the crossing site is tactically safe:

- Mines.
- Ice obstacles.
- Tank traps on ice.
- Demolitions/explosives (standard or improvised) under ice.
- Chemical, biological, radiological, and nuclear (CBRN) hazards.

---

### During Reconnaissance

---

The information to be collected during reconnaissance is far more than just ice thickness. The following information must also be collected:

- Ice thickness and its formation or quality.
- Snow thickness on the ice.
- Snow thickness on the banks.
- Ice attachment to the banks. Does it hang over the water?
- Slope angle and composition of banks.
- Width and depth of water.

- Current speed and the slowest current area.
- Weight bearing capacity of ice.
- Theoretical growth of ice based on weather patterns.
- Best routes for main and secondary crossing.
- Requirements to make the crossing site suitable.
- Natural material available for reinforcement.

---

### Tools and Special Equipment Required

---

The following tools and special equipment will be needed to conduct an ice reconnaissance:

- Ice measuring rod.
- Ice auger/axe bar.
- Chisel/spud.
- Ice saw.
- Weighted depth cord.
- CBRN detectors.
- Probes.
- Mine detectors (improvised explosive detector dogs, if available).
- Belay rope.
- Thermite grenades.
- Axe.
- Ski poles or staff.
- Demolitions.

*Note: Equipment carried depends on availability and need.*

---

### Ice Classification

---

Ice is classified in three general types—saltwater ice, freshwater ice, and land ice.

## Saltwater Ice

Saltwater ice is weaker than freshwater ice. Saltwater ice first forms in crystals within the layer of salt water affected by convection. These crystals give saltwater ice an oily or opaque appearance. Saltwater ice is classified by its concentration as pack ice, drift ice, fast ice, and ice foot. Sea ice older than one year is much stronger than young sea ice. Young sea ice must be at least 1.66 times the thickness of old sea ice to carry the same load.

Pack ice is formed on the open sea, remains packed together, and is influenced by currents and winds. When pieces of ice break off the pack, they are called drift ice. Pack ice seldom grows thicker than 5 to 7 feet in the first year, but has attained thicknesses of 12 feet in the polar basin where pack ice is perennial. Telescoping and piling up of ice floes can create ice thicknesses of up to 125 feet around the edges of the pack. Although the interior of the pack is solid and relatively smooth, it is usually not smooth enough for airstrips without some grading. Currents and winds constantly fracture pack ice, leaving lanes or leads of open water. When the leads freeze, they provide sites of smooth ice, which make good airstrip locations. The length of such an airstrip must be double the normal length for a fully loaded aircraft to take off.

Fast ice is either attached to the shore (land-fast) or otherwise confined so that it does not drift. An example of fast ice is ice in a bay or lagoon. The portion of fast ice that is attached to the shore is called the ice foot. Fast ice may be attached to the ice foot or be separated from the ice foot by a crack. Fast ice rises and falls with the tide, but the ice foot remains fast to the shore. The more irregular the shoreline and the greater the number of islands in the area, the wider the fast ice will be. Fast ice provides better movement routes and emergency landing fields than does pack ice.

## Freshwater Ice

Freshwater ice begins to form on lakes and rivers under normal conditions, from 3 to 5 weeks after

the daily temperature drops to 32 °F. Rates of formation and types of ice vary tremendously. Freshwater ice has fewer defects and is stronger than sea ice.

Lakes generally freeze with a smooth surface, and, as the ice thickness increases, no crystalline structure shows. The surface retains its smooth, dry, polished appearance. Lake ice is generally weak in the areas of streams, inlets, springs, or outlets. Decaying vegetation on the bottom of a lake may give off air bubbles, which slow ice formation and create weak ice. These bubbles are trapped and visible in the ice.

Ice that forms on wide, slow-moving rivers frequently has the same smooth appearance as lake ice. Warm weather and wind may, however, create a rough surface, which will remain rough throughout the winter. This ice is filled with air bubbles. In cold water (below 32°F), ice will form around solid particles in fine, spicular, sharp, pointed crystals in loose spongy masses called frazil ice or slush ice. Frazil ice floats upward and can accumulate to great thickness under ice sheets to become an integral part of the river ice.

## Land Ice

Land ice is ice on top of land/solid objects, not water. It presents a slippage hazard only and requires no further discussion.

---

## Ice Growth

---

Normally, fresh water does not freeze to a thickness greater than 8 feet in a single season. In lakes, the normal ice depth by late winter is from 3.5 to 6 feet, depending on winter temperatures. The strength of the ice depends on ice structure, purity of water, freezing process, cycles of freezing and thawing, crystal orientation, temperature, ice thickness, snow cover, water current, under-side support, and age. There are four types of ice

formations found on inland rivers and lakes—blue, chandelier, rotten, and unsupported ice.

### Blue Ice

Blue ice is by far the best quality. Normally, the color is light blue or green in shallow areas and black over deep water. In some cases, where the water depth is less than 3 feet the ice will be clear and the bottom visible. A few cracks may be visible, but are not a sign of weakness if they run in the same direction as the current. These cracks are caused by ice contraction in extreme cold; no bubbles should be present.

### Chandelier Ice

Chandelier ice is normally encountered in the spring. Water covers the surface of the ice during formation due to surface melting or an upstream breakup, which floods the surface. Chandelier ice is formed when this water percolates/melts through the remaining ice to reach the water below. The ice then appears as a series of icicles, like a chandelier. Because the horizontal strength of the ice has been weakened, there is no cohesion for strength. This ice is dangerous to cross even though it may be 5 to 6 inches thick.

### Rotten Ice

Rotten ice can be encountered at any time. It can be caused by a thaw or by incomplete freezing. In wintertime it can be caused by bogs, rotting vegetation, and sewers; which indicates the presence of contamination. Generally, it is dull and chalky in color and very brittle. Rotten ice should not be used.

### Unsupported Ice

Ice is unsupported when there is a space between the ice and water. This ice is a common hazard found in areas where the water table has fallen due to tidal action and in areas upstream of power dams through spillway release. Unsupported ice can be detected by cutting a hole in the ice. If the water rises less than three-quarters of the way up the side or does not rise at all, then the ice is unsupported and should be avoided. It is a very dangerous condition.

---

### Ice Formation Rates

---

When predicting crossing site sustainability, Marines must consider the factors that will speed up or slow down ice formation. The following factors will speed up freezing:

- Low, stable temperatures.
- High wind-chill factor.
- No snow cover.
- No current.

The following factors will slow down freezing:

- Fluctuating temperature.
- Fast current.
- Snow cover.
- Salt water/other impurities.

The amount of ice required to support men and vehicles with the proper interval can be seen in table 3-1 on page 3-4.

**Table 3-1. Ice Safety Table.**

<b>Item Loaded</b>	<b>Weight in Tons</b>	<b>Ice Thickness Needed (centimeters/inches)</b>	<b>Distance Apart Needed (meters/feet)</b>
Man on skis/snowshoes	0.1	3/1.2	5/15
Man on foot	0.1	5/2	5/15
Horse	0.5	10/4	5/15
Horse-drawn sled/cart	1	15/6	15/50
BV-206	2	15/6	15/50
Armored personnel carrier	3	20/8	15/50
Bulldozer	5	25/10	23/75
7-ton truck and load	10	33/13	32/105
Tank	68	122/48	92/300

# CHAPTER 4

## MILITARY SKI EQUIPMENT

This chapter contains technical information for military skiing, ice mobility and countermobility, over-the-snow casualty evacuation (CASEVAC), and over-the-snow vehicles. Mountain leaders will combine the information in this chapter with the information contained in MCWP 3-35.1 and MCRP 3-35.1A to augment their knowledge of mountain and winter operations.

For well-trained Marines, skis provide not only flotation over the snow, but also a more efficient and much accelerated means of moving over snow-covered terrain. To achieve proficiency on skis, Marines require approximately 3 to 4 weeks of concentrated ski training. This initial investment of time will enhance a unit's ability to conduct mountain operations in the intelligence, maneuver, and force protection warfighting functions. Once mastered, skis are the most effective and reliable means of transportation in a snow-covered environment.

The military currently issues Asnes double cambered skis, which have a hole in the tips for towing. These skis vary in length from 190 to 210 centimeters and are issued depending on the

skier's weight; heavier Marines should receive longer skis. Alpine touring (AT) skis are under development (along with an AT binding and mountaineering boot) for use by intelligence, surveillance, and reconnaissance (ISR) assets, mountain leaders, and scout skiers.

---

### Nomenclature of a Military Ski

---

The following are the common parts of a ski (see fig. 4-1):

- *Tip*. The forward point of the ski.
- *Shovel*. The curvature at the front of the ski that helps push aside the snow as the ski moves forward.
- *Tail*. The rear of the ski. It has a notch in the center for attaching climbing skins.
- *Base*. The bottom of the ski, which is made from a synthetic material called P-Tex®.
- *Camber*. The bow in the center portion of the skis. It is often referred to as the wax pocket. When a Marine puts weight on the ski, he will notice that the bow will flatten. The amount of

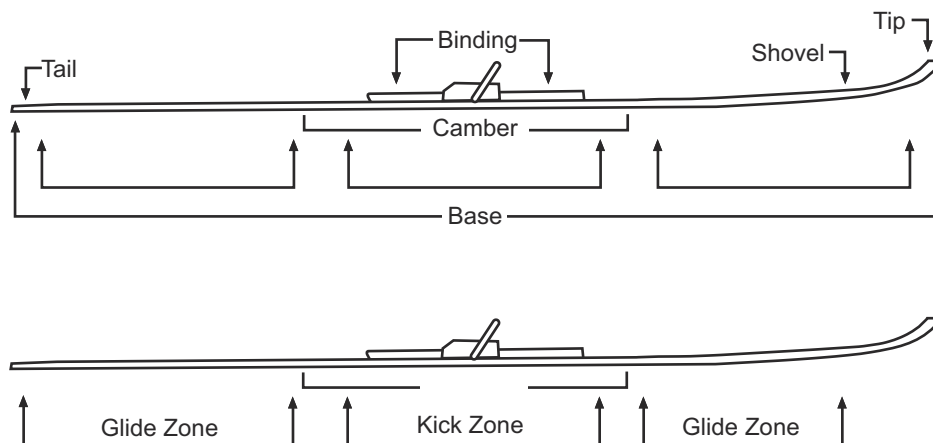

Figure 4-1. Ski Nomenclature.



weight needed to flatten the bow depends on the skier's weight and ability.

- ◆ *Single camber.* The camber in the ski is soft so that more of the ski is in contact with the snow, making steering easier and providing greater control.
- ◆ *Double camber.* The "stiffness" in the camber of the ski. A double camber ski will require more force to flatten out, causing steering to be more difficult, but the stiffer ski will have a better gliding and grip wax pocket. The Asnes ski is a double camber ski.
- *Binding.* Holds the boot to the ski. The current ski binding is the North Atlantic Treaty Organization (NATO) 120 binding. It is an all-metal binding, consisting of a cable clamp, toe plate, and a cable, and is discussed further in the adjacent column. New bindings are in development for mountaineering boots for mountain leader, ISR personnel, and scout skier use.
- *Tracking groove.* A U-shaped cut going from just below the tip down to the tail. It is designed to help the ski run over the snow in a straight line. Without the groove, the ski will tend to wobble or move from side to side.
- *Kick zone.* This area is located within the camber and is where the wax is applied. The kick zone will vary due to a Marine's weight and ability and the terrain being skied. As a general guideline, the zone begins six inches before the binding and extends to 6 inches beyond the binding.
- *Glide zone.* This area remains in contact with the snow surface. The glide zone runs from the ends of the kick zone to the respective ends of the ski.
- *Metal edge.* The edge can be offset or flush with the running surfaces of the ski and is essential for mountaineering skis.
- *Side wall.* The side covers of the ski that protect the core of the ski from warping due to water damage.

- *Side cut (waist).* The difference in width measurements from tip to tail. The side cut makes the ski easier to turn when pressure is applied on the ski at an angle to the snow surface.
- *Flex.* There are three types of flex—
  - ◆ *Tip flex.* Soft tips follow the terrain by easily flowing over bumps, dips, and irregularities in the snow. If the tip is too soft, the ski tends to wander and become difficult to control in turns. Moderate tip flex is more desirable for backcountry touring and mountain skiing, providing better flotation in powder and adequate control when turning.
  - ◆ *Tail flex.* Similar to tip flex in its response to snow and turning. If it is too soft, the ski may wash out or not hold an edge while turning.
  - ◆ *Torsion flex.* The twisting action from side to side that a ski experiences while in a turn or track. A good touring or mountain ski has a torsionally stiffer tip, which gives the ski more holding power and better edge control when turning.

---

## Ski Binding

---

Currently, the NATO 120 binding is being used because it can be fitted to the vapor barrier boot and a 75-millimeter Nordic norm, box-toed, ski-march boot (used by some NATO countries and, at times, open purchased by Marine units). A new binding is in development for use with a dedicated mountaineering boot, which will be issued to ISR personnel to support the full range of ISR operations.

The following are parts of the NATO 120 ski binding (see fig. 4-2):

- *Toe plate.* Consists of a wing nut fastener, locking lever, and two adjustable toe plates designed for proper emplacement of a boot toe.

A toe strap is used across each toe plate to hold the boot down.

- *Cable clamp.* Located in the front of the binding and is designed to tension the cable around the boot. The cable clamp also has a retractable nut, which allows for two full sizes of adjustment of a cable to a boot.
- *Cable.* A plastic coated cable with a coil spring that fits behind the back of the heel. The cables come in four sizes and have a different colored band representing the size rating of that cable. Table 4-1 contains the color and corresponding boot size.

**Table 4-1. Cable Sizing Chart.**

Band Color	Size	Boot Size
Blue band	Extra large	12 to 14
Black band	Large	10 to 12
Green and Yellow band	Medium	8 to 10
Red band	Small	6 to 8

*Note: Blue band cables must be ordered separately; all other cables are SL [stock list]-3 to each binding assembly.*

To adjust the NATO 120 binding, perform the following:

- *Toe plate.* Due to the different boot sizes used with this binding, the adjustment of the toe plate is always necessary. It may be necessary to mark which ski is left or right since each toe plate will be adjusted differently. To adjust the toe plate, Marines must—
  - ◆ Loosen the wing nut and lift the locking lever.
  - ◆ Place the toe of the boot behind the wing nut, ensuring that the heel of the boot is centered on the ski.
  - ◆ Align the toe plates against the welt of the boot and push the locking lever back down into its original position.
  - ◆ Tighten the wing nut until no movement can be felt from the toe plate.
- *Cable clamp.* These clamps must provide the proper tension and be secured down. Minor adjustments to the tension can be accomplished by unscrewing or tightening the nut. Once the cable is clamped down, there should be no lateral movement of the boot.
- *Cable.* Correct cable length for the appropriate boot size and the cable clamp will compensate for the proper adjustment. Attention to the correct cable length for the boot size is important.

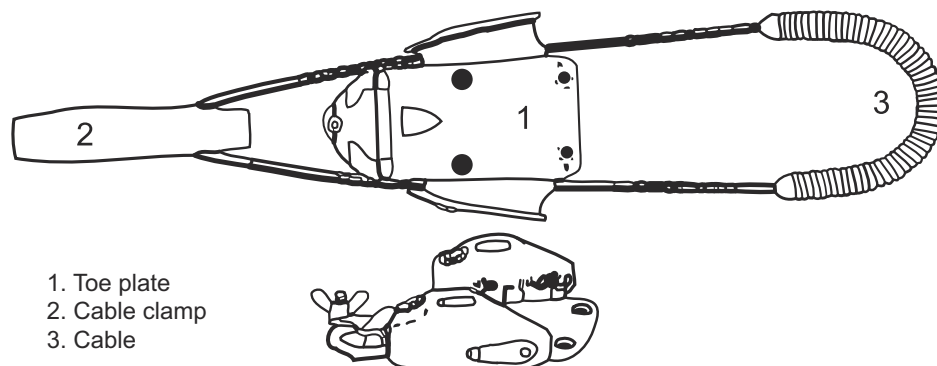

**Figure 4-2. NATO 120 Ski Binding.**

## Military Ski Poles

Ski poles (see fig. 4-3) aid the skier in movement, balance, and timing and have the following characteristics:

- *Wrist straps.* The wrist strap should be adjusted to support the wrist for pushing while cross-country skiing. Once adjusted, they should not be cut as different types of gloves or mittens will require readjustment.
- *Handgrip.* The handgrip is made of a hard plastic. Some poles are designed with detachable color-coded handgrips, which indicate that the poles can be converted into an avalanche probe pole. In order to transform the ski poles into a probe, it is necessary to have a red top handgrip, representing a “male” pole, and a white top handgrip, representing a “female” pole. To convert the ski poles to an avalanche probe pole, Marines must—
  - ◆ Remove the color-coded handgrips by unscrewing them from the poles.
  - ◆ Screw the male end into the female end.
  - ◆ Remove a basket from one end of the pole.
- *Shaft.* The shaft is made from a single hollow piece of aluminum.
- *Basket.* The basket is located near the bottom end of the pole. This basket allows the pole to remain above the surface of the snow during pole plants.
- *Point.* The point is located at the end of the pole and is also known as a ferrule. The point penetrates the snow surface during pole plants.

The current military ski pole comes in three lengths: 130 centimeters, 137 centimeters, and 147 centimeters. To properly size a pole to an individual, its tip should be placed on the deck and the handgrip should fit snugly in the individual’s armpit. Adjustable ski poles are preferred and available. Each adjustable pole weighs approximately one-half pound, while a nonadjustable pole weighs about one pound.

## Care and Maintenance of the Military Ski

Serviceability checks and proper care and maintenance are required in order to maintain ski equipment.

### Serviceability Checks

The following items must be checked by Marines for serviceability:

- *Delamination.* Delamination occurs when the plastic coating separates from the ski, causing water damage to the inner core. Skis should be frequently checked for nicks and gouges in the coating.
- *Ski base.* The ski base should be uniformly flat and smooth. Marines should check for possible gouges and cuts, which may hamper the glide of the ski and create problems in waxing. Any gouges or cuts should be filled to prevent an unstable ski.
- *Ski edges.* If the ski edge is separated from the ski, mobility will become difficult, especially when turning or edging.

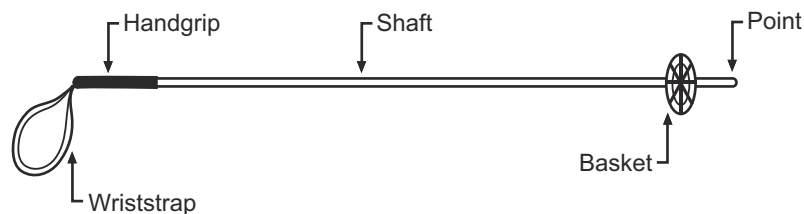

Figure 4-3. Military Ski Pole.

- *Bindings.* Marines should check all metal parts for stress fractures and missing parts, ensuring that the cable is not missing large sections of the plastic coating or that the coil spring is not over stretched.
- *Detuning.* Detuning is a process of dulling the edges. If the skis are new, the metal edges are very sharp. Detuning the tips and tails approximately 6 inches on both sides will help prevent skiers from “catching an edge” and is done with a standard file moving from the tip toward the tail.

### Care of the Ski

Military skis should be cared for in the following ways:

- *Heat.* Skis should not be placed next to direct heat because the bottom of the ski could easily melt. Skis should not be attached too close to the exhaust pipes on tracked vehicles.
- *Snow/ice.* Snow and ice should be removed from the skis before staging overnight.
- *Waxes.* All wax should be removed before staging skis overnight or skiing with old wax on new snow conditions may result.
- *Staging skis.* Placing the tails of the skis straight into the snow may damage the tails if a hidden object, such as a rock or tree stump, is struck. Skis should be staged during breaks by directing the base of the ski toward the sun using the poles for support, which will keep the grip wax fresh and pliable.

### Maintenance of the Ski

The base and edges of skis become damaged through normal use, requiring maintenance by the skier. For base preparation, base glide wax is used to protect the ski's synthetic base and to maximize the forward speed of the ski. The simplest method for waxing is to rub the wax directly on the base; however, hot waxing allows the wax to penetrate deeper and last longer.

Metal edge tuning can be difficult when the ski's metal edge is dulled or pitted. The edges should

be sharpened as needed, except in the shovel and tail area. These two areas should be detuned for maximum turning efficiency. To tune, the file is held parallel and lengthwise against the side of the edge, filing from the tip to tail and keeping the file at a 90-degree angle to the base. Excessive filing should be avoided. The first 6 inches of the tip and the last 3 inches of the tail should be slightly dulled (detuned).

---

### Ski Waxing

---

Wax is applied to the base of the skis to prevent slipping, influence momentum, and help maintain glide. The goal of waxing is to find the proper wax combination for optimum grip and glide without sacrificing either. As the snow conditions and temperature change, the wax required will also change.

### Ski Waxes

Each wax has a range of ideal snow conditions. The type of snow (wet or dry) and the temperature affect the wax chosen and how it is applied. The Marine Corps uses a simple, two-wax system, which is part of the Marine Corps Cold Weather Infantry Kit (MCCWIK) (see table 4-2).

**Table 4-2. Two-Wax System.**

Wax	Snow Temperature (°F)	Usage
Blue	5° to 32°	A wide range wax for normal cold snow
Red	32° and warmer	Ideal for conditions around freezing and slightly warmer

### Wax and Its Effects on Snow

When wax is spread on the ski's base, it provides a cushion to which thousands of snowflakes can adhere. For a moment, when the skier's weight is on one ski, snow crystals are embedded in the wax, holding the ski firm while the skier pushes

off. As the ski begins to slide forward, the pressure release and friction of the sliding ski releases this bond. A thin layer of water (a result of friction between the ski's base and the snow) causes the ski to glide until it stops and downward pressure is again applied.

### Proper Selection and Application of Ski Waxes

Grip waxes are formulated to provide optimum gliding and gripping characteristics for various types of snow and temperatures. Each type is labeled with appropriate instructions on its intended use in various weather conditions. Since the type of wax varies among manufacturers, no particular type of wax can be prescribed for each classification of snow; however, the instructions on each container specify the weather conditions and the type of snow in which wax performance is best. To provide a proper grip, varying amounts, combinations, and methods of application of different waxes may be used. Tips for applying grip wax include—

- Wax in the temperature being skied.
- Ski should be dry when waxing.
- The wax should be corked in from tip to tail.
- Grip waxes may be crayoned on and then corked in.
- When in doubt, start with a harder (colder) wax.
- Do not apply a harder on top of a softer (warmer) wax.
- Several thin layers work better than one thick layer.
- During movement, carry wax in an inside pocket to keep it warm.

- Do not put newly waxed skis on the snow until the wax has cooled to the air temperature. If the lead group has a specific wax on for the starting conditions, the trailing group might want to use a warmer or colder wax due to track conditions left by the lead group.
- Before Marines move out on skis, they should test the waxing job and re wax, if necessary. It will normally take several hundred feet of skiing for the wax to function properly.

### Wax Kit

The wax kit (currently part of the MCCWIK) includes two grip waxes (the two-wax system), a cork, and scraper.

### Climbing Skins

Climbing skins are made from synthetic fur called mohair. These mohair strips attach to the bottom of the skis, which allow the skier to slide forward, but not back. Skins are used for ascending moderate to steep terrain or pulling sleds and are currently located in the MCCWIK. Climbing skins (see fig. 4-4) include—

- *Skin*. A skin has two distinct sides: an adhesive side and a mohair side. The adhesive side is placed against the base of the ski. The mohair side is exposed to the snow.
- *Heel clamp*. The heel clamp secures the skin to the tail of the ski.

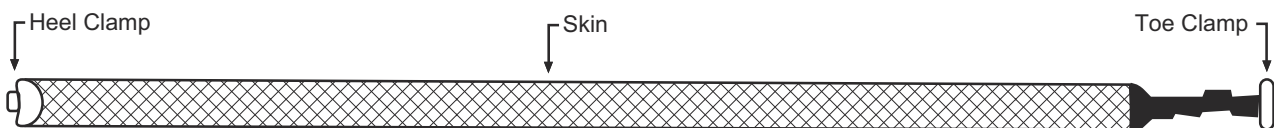

Figure 4-4. Climbing Skin Nomenclature.

- *Toe clamp.* The toe clamp secures the skin to the tip of the ski. It is normally equipped with a rubber tensioning device.
- *Fitting.* The M-buckle located on the toe clamp is held in place by inserting the actual skin through the buckle and folding it behind itself. To adjust skins, the folded adhesive should be pulled apart. When the correct length is attained, the skin is folded back on itself.

To maintain the adhesive side after each use, the skins must be air-dried. To store when not in use, Marines should find the midpoint and fold the two adhesive sides on themselves, then store the skins in their carrying bag. When in the field, skins should not be left on skis overnight, but placed (folded at the midpoint) between the sleeping mat and sleeping bag. The warmth will reactivate the skin glue for the next use.

This Page Intentionally Left Blank

# CHAPTER 5

## SKI TECHNIQUES

The goal of combat skiing is to provide flank security and overwatch in support of large unit movements and to enable reconnaissance and security elements with an enhanced mobility option. Combat skiing is a combat multiplier; if done correctly, skiing gives Marines an edge in combat.

A force must have mobility at least equal to its enemy if it is to succeed. Snow-covered terrain limits mobility, making cold weather operations more difficult than operations in other climates. For Marines to have the mobility to successfully maneuver, they must learn to ski effectively and be trained in route selection. Combat skiing will enhance mobility, giving Marines the ability to move across snow-covered terrain, steep slopes, and through bush- and tree-covered terrain that cannot be crossed on foot or snowshoes.

All ISR Marines and Sailors, including attachments, such as forward air controllers, forward observers, and naval gunfire ground spot team members, should be ski trained. Some ISR units will need more training than others. For example, the force reconnaissance company will need to be highly skilled to accomplish their mission, the air/naval gunfire liaison company will need highly developed skills to keep up with the allied unit to which they are attached, and overwatch personnel (mountain pickets) in larger, conventional units should also be proficient scout skiers in snow-covered terrain.

The skiing skills in this chapter are organized in a logical progression that winter mountain leaders can use to introduce Marines to combat skiing. It is assumed that the initial instruction will be provided to the inexperienced Marine. All skills teach basic balance and movement. Training begins on a flat, snow-covered surface. As the task becomes more difficult, skills are introduced

that will enable skiers to negotiate more difficult terrain. Weather and surface conditions impact the level of individual skills that a group of Marines can achieve in a given time. Initial instruction should be kept basic to provide a solid foundation. Basic techniques of military instruction should be followed: explaining and demonstrating any new terms, such as “fall line” or “snow plow,” that may be unfamiliar to students. After describing the basic skill, instructors should demonstrate it from a front, side, and rear view.

Skiing is a balance and movement activity that Marines will learn only through application. *Marines must practice.* Scout skiers must master all snow and weather conditions. After completing initial instruction, Marines should train with packs, weapons, and equipment in all environmental conditions and levels of visibility.

---

### Falls and Injuries

---

Falls and the resulting injuries must be minimized. Falls will slow down the unit; injuries may compromise the mission. Marine ski instruction must *always* emphasize terrain selection—the most important consideration for avoiding injuries and accomplishing the mission. Because all Marines are potential leaders, they may, at some time, lead the ski march. The skill level of the most inexperienced or least skilled Marine/Sailor should be considered when selecting the route of march.

The cost of an irresponsible act on skis is the loss of at least 4 and possibly 8 to 12 Marines from a unit’s combat strength, which directly affects medical emergency evacuation. Therefore, responsibility is the most important concept in Marine



ski instruction. When someone is injured during instruction, the ski instructor is responsible. If a Marine is injured during a ski march, the small unit leader is responsible. This theme of responsibility must be communicated to all Marine leaders and skiers.

---

## Warmup Exercises

---

To avoid overheating, minimal clothing should be worn and removed as Marines warm up. To warm up the body for skiing, Marines without skis and poles should—

- Work the neck, arms, legs, and ankles in circles.
- Jog or march in place to raise the heart rate.
- Jog in place with leg kicks.
- Do some lunges, alternating legs and keeping the back erect.

With skis and poles, Marines should do the following stretches without bouncing, using poles for balance:

- *Knee lift.* Assume the basic athletic stance (described in the following section). Pull up the knee with the arms as high as possible.
- *Hamstring stretch.* Place ski tail on snow, stretch toward the knee.
- *Quadricep stretch.* Place the tip of the ski behind the skier, lean back, and pull the ski tail forward.
- *Groin stretch.* Assume the herringbone position, feet spread. Bend the knees, stretch forward and sideways.
- *Back bend.* Assume the basic athletic stance. Bend backwards.
- *Toe touch.* Bend from the waist and touch toes.
- *Side bends.* Assume the basic athletic stance. Hold ski poles behind back and bend side to side.

- *Trunk rotation.* Assume the same position as side bends and twist upper torso in both directions.
- *Lunges.* Deep lunge until quadriceps stretch.
- *Back and leg stretch.* Bend toward toes, reach between legs, grab ankles, and try to stand.

---

## Ski Moves and Stances

---

### Basic Athletic Stance

A neutral stance with the balance over the center of the whole foot and both skis evenly weighted. The foundation for all ski movement.

#### Teaching Terrain:

~ Flat or nearly flat ground.

#### Body Position/Mechanics:

~ Knees and ankles are comfortably flexed; arms are loose and relaxed with slightly flexed elbows. The trunk is relaxed. The head is upright with eyes forward.

#### Instructional Techniques:

~ Demonstrate.

~ Equate this stance to an athlete in the “ready” position; i.e., a linebacker or a basketball player ready to move in any direction. Tell students to find a balance point over the center of the foot by leaning forward and backward until they feel a comfortable balance point.

### Telemark Position

A neutral stance with one foot ahead of the other—not applicable for AT skiing. The basic balance position when moving on skis with the heel free.

#### Teaching Terrain:

~ Flat or gently sloping ground.

#### Body Position/Mechanics:

~ Center balance on the whole of the front foot and ball of the back foot with both skis evenly weighted. Knees and ankles are comfortably flexed; arms are loose and relaxed with slightly flexed elbows. The trunk is relaxed. The head is upright with eyes forward.

**Instructional Techniques:**

- ~ Demonstrate standing still.
- ~ Explain that the telemark position provides forward/backward stability when working with the free heel military binding system.
- ~ Show how the basic athletic stance leads into the upper body position of the telemark stance. From the telemark stance, students can move into the telemark glide.

**Star Turn**

This turn is used to change direction when stationary on a flat surface or to change direction when snow conditions, terrain, skiing ability, or load prohibit the use of other turning skills.

**Teaching Terrain:**

- ~ On flat ground.

**Body Position/Mechanics:**

- ~ Start with the basic athletic stance.
- ~ Flex the knee to pick up the tip of the ski.
- ~ Move the tip to one side, forming a "V" position with the skis and lower the foot.
- ~ Bring the other ski parallel with the first.
- ~ Repeat.
- ~ Use poles for balance.

*Note: This turn requires a high knee lift to raise the tip of the ski out of the snow. Some students may need some time to adjust, especially in new or loose snow. Use poles for balance.*

**Instructional Techniques:**

- ~ Turn around the tails.
- ~ Demonstrate a 360-degree turn, keeping the tails of the skis together.
- ~ Point out that the tails of the skis remain fairly close together and on the snow.
- ~ Turn around the tips.
- ~ Demonstrate a 360-degree turn, keeping the tips as the pivot point and moving the tails into an "A" position.

**Extra Practice:**

- ~ Tell students to execute the turn around the tails without poles. Then, tell them to execute the turn around the tips without poles. Tell students to alternate moving tips then tails without poles. This practice will prepare

students to move in tight places where they cannot complete a full turn in one place.

**Controlled Fall**

A method of safely stopping after losing control. The skier uses this fall to prevent injury. It also helps beginners gain self-confidence.

**Teaching Terrain:**

- ~ Flat ground for a static fall (fall while standing still) or a gentle to moderate slope for a dynamic fall (fall while moving).

**Body Position/Mechanics:**

- ~ Lean toward the slope and sit down, landing on the hip. If the left side of the body is closer to the slope, the skier will land on the left hip. If the right side is closer, the skier will land on the right hip.
- ~ Raise the pole out of the way of the fall.
- ~ Lean back into the slope, allowing hands to trail over the head and the poles to fall naturally.
- ~ Slide to a stop as if sliding into base in baseball.

**Instructional Techniques:**

- ~ The instructor demonstrates both falls on the appropriate terrain.

**Recovery From a Fall**

A method of regaining an upright position and returning a downed skier to the basic athletic stance while on skis.

**Teaching Terrain:**

- ~ Flat ground or gentle to moderate slopes.

**Body Position/Mechanics:**

- ~ Evaluate the position on the hill.
- ~ Determine the position in relation to the fall line. (The fall line is the most direct route downhill. A dropped ball rolls down the fall line.)
- ~ Place the skis downhill from the body.
- ~ Position the body so that it aligns with the fall line and so that the skis are at a 90-degree angle to it.
- ~ Pull the skis up as close to the hips as possible while keeping them perpendicular to the fall line and close together.

- ~ Remove the ski pole straps from the wrists.
- ~ Place the tip of one ski pole through the basket of the other.
- ~ Place the ski pole tips into the snow next to the hip on the uphill side. The hand closer to the snow grasps the poles near the basket. The other hand grasps the ends of the poles.
- ~ Push away from the hill.
- ~ Start straightening the legs. The hand closer to the baskets should work its way up the poles as weight is put on the skis.

**Instructional Techniques:**

- ~ Students may have to remove their packs and other equipment to get up.
- ~ If in deep snow and the poles sink, cross the poles so the baskets are 90 degrees apart. Use them as a base of support to push away from the hill.

## Kick Turn

A stationary turn that moves the skier in the opposite direction, to change direction 180 degrees when other techniques are undesirable or ineffective. It is particularly useful on narrow trails or where the snow is deep. It is appropriate for slopes, whether going uphill or downhill.

**Teaching Terrain:**

- ~ Taught best on flat ground or gentle to moderate slopes.

**Body Position/Mechanics:**

- ~ In the initial body position, the lower body faces in the direction of movement while the upper body turns and faces downhill. Skis should be parallel. The body weight is on the nonkicking leg. If on a hill, the nonkicking leg is the uphill leg.
- ~ Plant the poles above the uphill ski for support. The poles help maintain balance during the turn and support body weight. The poles should remain planted throughout the entire maneuver.
- ~ Kick the downhill ski and leg forward and up.
- ~ Rotate the ski, turning the toe outside, and place the foot down so that the skis are parallel with the downhill ski and facing in the opposite direction.
- ~ Transfer body weight to the ski facing in the new direction (the downhill ski).

- ~ Bring the uphill ski around, placing it parallel to the other ski. Now, both skis face in the new direction.
- ~ Lift the ski pole to follow the moving leg.

**Instructional Techniques:**

- ~ Practice ski balance drills.
- ~ Demonstrate the turn on a flat surface and instruct students to practice the turn on flat ground, then demonstrate and have students practice on a slope.
- ~ Emphasize maintaining three points of contact throughout the turn—the two planted poles and one leg.

## Diagonal Stride

The fundamental Nordic technique for flat or slightly uphill terrain. It stems naturally from the telemark position. It is similar to running, but the feet glide on the skis and the hands push back on the poles. The term diagonal stride refers to the simultaneous movement of the diagonally opposite arm and leg. If on AT skis, there is no dynamic movement, just walking on skis. The diagonal stride is the most used technique for forward motion in cross-country skiing. It provides rhythm and efficiency.

**Teaching Terrain:**

- ~ Start the students on flat terrain. Well-defined tracks deep enough to hold the skis will aid learning. As students progress, the terrain should also increase in difficulty to include mildly rolling tracks or a slight uphill slope.

**Body Position/Mechanics:**

- ~ Keep the head up with the eyes focused down the track.
- ~ Timing in the diagonal stride requires coordination of arm and leg movement. As in walking, the opposite arm and leg work together.
- ~ Arms are comfortably flexed at the elbow and wrist when planting the pole. This angle is maintained as power is initially applied to the pole. Power increases until the hand passes the hips and the arm is totally extended and straight.
- ~ The tip of the pole should be planted approximately even with and just outside the tip of the lead boot (the opposite foot). On the vertical plane, the pole handle is moved ahead of the baskets. As the pole is planted, the skier exerts downward and backward pressure on the

pole, providing a propelling force as the arm extends to the rear. The push action occurs as the knee comes forward. The degree of follow-through varies with speed. As speed increases, more follow-through is needed.

~ Advanced skiers plant the pole immediately after pushing off with the leg. Pole pressure helps maintain momentum on the gliding ski for as long as possible.

~ The poling arm should swing forward near the body when the feet come together to maximize glide before another pushoff.

~ The skier pushes off to start one ski to glide and then pushes off on the other ski before the first one stops. The motion is similar to walking, but only the heel rises as the body moves forward. A slow motion at first develops into a more powerful compression of body weight on the pushoff ski. A quick explosive pushoff is the main source of acceleration.

~ Before pushoff, the skier is erect. Then, at the moment of pushoff, the body leans slightly forward while the leg remains vertical. The knees, ankles, and hips are slightly flexed to tense the muscles prior to the pushoff and leg extension. The whole foot pushes down and back, which causes the wax to grip and creates a stationary platform from which to project forward. At the end of a pushoff, the leg is fully extended back. The knee and ankle are extended. The degree of extension is in direct relation to the speed of the skier. The faster skier uses a full extension and the slower skier, less extension. The front or sliding leg supports the body while gliding. As the skier glides, the weight moves from the heel to the ball of the foot, but the knee angle remains constant. The knee and ankle of the front leg are flexed to help with balance and remain flexed for the next pushoff.

#### **Instructional Techniques:**

~ The instructor should select wax for the students and supervise its application. Students must feel their skis grip to practice this skill.

~ Instructors may be unable to provide ski poles of proper length to the students, which may affect the efficiency of pole use.

~ Teaching the diagonal stride is similar to teaching all cross-country skills. Three key areas of instruction are the ability to glide, to pole, and to push off on the ski. Each of these areas should be taught separately, focusing on timing and balance; speed will develop accordingly. Exercises should be used during the lesson to practice these skills and to analyze students' progress.

~ Students can experiment with the equipment by moving along the track. With practice, students can see that simply walking leads easily into military skiing. After the

students have experienced the initial excitement of skiing, they can continue with easy movements with or without poles.

~ Omitting poles at the start of the lesson removes confusion about their use. Students can then concentrate on moving the skis and developing a natural arm swing.

~ First, demonstrate an easy push and glide so that the students can see a side view. Tell students to stand in a relaxed, upright position; slide the skis on the snow; swing their arms at their sides; take small strides; try to feel a little glide after each push from the ski; and try to feel the weight on the gliding ski.

~ Have the class practice with an easy, slow push and glide. The heel should rise off the ski slightly as the skier pushes. The arms should also swing in time with the legs. As balance and confidence improve, more power comes by pushing harder off the skis. The body leans forward, and the back ski may naturally lift slightly off the snow. Stress a relaxed, upright position since it is restful and quite efficient. When bending forward and using overly bent knees, the skier uses too much energy and load carrying is adversely affected.

~ The faster a skier moves, the farther ahead the pole is planted and the closer the pole shaft is to vertical. When speed slows down, plant the pole farther back to allow immediate pull and push. Faster skiers plant the pole straighter because of increased momentum and because the pole is at a working angle by the time pressure is applied.

#### **Extra Practice:**

~ *Poor balance.* Students with poor balance or a fear of sliding will need more practice time without their poles. The following exercises are helpful for the novice and advanced skiers. Precede each exercise with a demonstration followed by a concise explanation and practice. Demonstrate-instruct-practice is a good instructional routine.

~ *Exaggerated knee bend.* Stand straight and sink low, bending the knees. Keep the upper body erect and push off on the ski. Then, slide the other ski forward. This skill will be useful when a skier must absorb a bump or dip.

~ *Exaggerated arm movement.* Move arms forward in exaggerated motion, then follow through to a high back extension, which can become a timing practice for arms and legs. It also aids flexibility in the shoulder joint. Arms should move straight forward and back without crossing over in front.

~ *Quickski.* Take short, shuffling steps while keeping skis on the snow. Bring the arms up to the chest like a jogger. Start the pushoff from the whole foot and move the arms

in quick succession forward and back. This exercise will also loosen the shoulders. The speed will increase the breathing rate in the warmup stages.

~ *Weight transfer.* Balance on one ski while it moves and hold a stationary position over the gliding ski. Then, switch and balance on the other ski. This exercise works well on gradual downhills when the position can be held longer.

~ *Scooter drill.* This drill is effective for emphasizing dynamic weight transfer and pushoff. It requires firmly packed snow and a preexisting track. Have students remove one ski. Using both poles, students push off with the foot that has no ski and slide on the ski. Progress from two poles to no poles. Then, introduce using just one pole.

~ *Using the poles.* Pole use centers on a relaxed, loose arm swing. First, review how to grip the pole. Show how to bring the hand under and up through the strap so it falls around the wrist. Then, grip the strap and handle together. If the strap is adjustable, show how to adjust it so that the hand is close to the top of the handle. Next, plant the pole in the snow at an angle, pointing back in order to use it immediately to apply pressure. Look for proper technique while students practice pole use. Have students ski slowly and drag the pole basket in the snow when it is brought forward to be planted. Look for a light grip between the thumb and forefinger.

## Telemark Glide

A running or gliding position with the skis parallel and approximately shoulder-width apart. As the skier moves, one ski advances about one-quarter to one-half a ski's length. This technique is not applicable for AT skis. It enables the skier to absorb changes in snow conditions or terrain and to provide stability from front to rear, skiing across slopes with or without packs.

### Teaching Terrain:

~ All types.

### Body Position/Mechanics:

~ From the basic athletic stance, advance one ski forward of the other to increase the skier's forward and backward stability. The front knee is bent with the foot flat on the ski. The rear heel is lifted off the ski, resulting in ski-boot contact at the ball of the foot.

~ Flex the knees and slide one ski forward until the tip of the back ski is approximately half way between the binding and shovel of the forward ski.

~ Position the front knee over the toes of that foot. Bend the knee to form a right angle between the upper and lower leg. Raise the back heel off the ski and support weight on the ball of the back foot.

~ Stand relaxed as the skis glide in the snow about shoulder-width apart.

### Instructional Techniques:

~ Demonstrate static drill with change of leading ski.

~ Keep both poles planted for balance.

~ Practice sinking into the telemark glide position, alternating the leading ski.

~ When moving from the telemark glide position to the downhill running position, slide the new leading ski forward. Resist the temptation to let the rear ski move backward.

~ Then, change the lead ski, maintaining the basic telemark position.

## Double Poling

A technique for forward propulsion. Using both poles simultaneously, double poling maintains or increases speed on downhills or as an alternative to other techniques on flat terrain. Double poling is used primarily on downhills.

### Teaching Terrain:

~ Gradual downhill sections of the trail, but can be taught on the flat sections. If taught on a steep hill, students may be unable to stop, so select a slope to match ability level.

### Body Position/Mechanics:

~ The arms swing forward and backward together. As the arms swing forward, plant the poles at an angle and apply pressure immediately, keeping a slightly flexed elbow. Compress the larger, stronger abdominal muscles and transmit this power through the slightly flexed arms to the poles. The angle between the upper and lower arm should remain constant during the initial phase of poling to better transmit muscular force to keep the skis gliding. The angle of the pole shaft varies with the speed.

~ As pressure is applied to the pole, the hand, forearm, and upper arm together lever on the pole shaft. The arms are slightly flexed. Remember, the arms are not the primary muscle group that produces the power. They are extensions that transfer the power of the major muscle groups of the upper body to the poles.

~ As the hands pass the hips, continue to push until the arms, hands, and pole shafts are in a straight line to the

rear. At the first extension, release the grip and point the fingers toward the pole basket. This technique shows why a properly adjusted wrist strap is important. The arms then swing forward in a relaxed pendulum motion.

**Instructional Techniques:**

~ First, demonstrate proper movements in a static position. Then, demonstrate by using the appropriate speed and tempo.

~ When enough speed and tempo are generated, have students reach forward with both arms extended and plant both poles at an angle (top of pole ahead of tip). Push on the pole until arms are extended straight behind.

~ Separate tracks allow individual practice.

~ Instructors can combine practice with the diagonal stride if terrain favors its use.

~ Practice reaching forward to plant the poles. Make a powerful pull, then push off with the poles. Start the pulling with the larger, stronger abdominal muscles and continue acceleration with the smaller muscles of the arm and wrist.

**Sidestep**

Helps a skier move uphill or downhill along the fall line through narrow, steep sections of a trail or very deep snow where no other technique is possible. Use the sidestep as a restful alternative to other uphill techniques or as a safe way to descend a slope.

**Teaching Terrain:**

~ Moderate slopes with some loose snow for easy edging.

**Body Position/Mechanics:**

~ Keep the skis perpendicular to the fall line with edges angled into the hill just enough to prevent the skis from slipping downhill.

~ Keep the body upright, weight over the feet, knees slightly flexed for balance, and head up.

~ Move the arms simultaneously or alternately, depending on snow conditions and slope steepness. The arms are used mainly for balance and support.

~ Be careful not to step on the ski pole baskets.

**Instructional Techniques:**

~ First, demonstrate the techniques of a sidestep going in both directions.

~ Find a section of open slope with consistent snow and tell students to practice the movements as demonstrated.

~ Remind students to practice the angling of the knees.

*Note: The instructor may have students practice the sidestep on the same slope that is to be used for downhill techniques so that it becomes packed and ready for the first run.*

**Forward Sidestep**

A combination of the diagonal stride and the sidestep used to traverse quickly up open slopes and wooded areas that are too steep for the diagonal stride. A skier can climb faster using this technique, although it is more strenuous than the traverse. The forward sidestep is secure when the skis stay perpendicular to the fall line and the inside edges are set.

**Teaching Terrain:**

~ Open slopes with fresh or loose snow. Fresh snow helps students see their tracks and makes edging easier.

**Body Position/Mechanics:**

~ Demonstrate the forward sidestep while showing a traverse and a forward uphill step.

~ Poles are used either diagonally or simultaneously with each step depending on slope steepness.

~ Moderate to steep slopes are ideal as practice terrain. To prevent slipping on steeper slopes, the skis must stay edged and perpendicular to the fall line. In deep snow, this requires a high-stepping motion.

~ Have students make their own tracks so that all can practice individually.

~ Instruct them to use the kick turn to change direction.

**Herringbone**

A method to climb straight uphill. The herringbone is faster than the uphill sidestep and more secure on steep terrain than the uphill diagonal stride, but it is generally more tiring.

**Teaching Terrain:**

~ Moderate to steep slopes. Some loose snow helps show students their tracks.

**Body Position/Mechanics:**

~ Initially, keep the body's center of gravity between the skis. The head should remain erect, especially when wearing or pulling heavy equipment.

~ Alternate poles or plant both at once while moving one ski at a time.

~ Depending on the steepness of the slope, keep the poles even with or behind the center of gravity.

~ When on steep slopes/wearing or pulling heavy equipment, put the hands on the top of the ski poles for extra leverage.

**Instructional Techniques:**

~ Introduce this skill on flat terrain.

~ Demonstrate on a slope that starts gradually and gets steeper.

~ Start students on a hill where they can practice the transition from the uphill diagonal stride to the herringbone as the slope steepens.

**Half Herringbone**

A technique to ascend moderate slopes where two edged skis are not required and the terrain precludes other uphill methods. This technique is less strenuous and is faster than the uphill sidestep and the herringbone.

**Teaching Terrain:**

~ Moderate to steep slopes. Some loose snow helps show students' tracks.

**Body Position/Mechanics:**

~ Position skis at a 45 degree angle to one another (one ski in a track, the other angled). Slide the ski that is in the track in the snow. The skier should feel pressure against the top of the toes as the ski that is angled is picked up. The angled ski is lifted and placed ahead on its inside edge.

~ The poles are used as in the diagonal stride. If more stability is needed when carrying heavy loads, the hand can be placed on the top of the ski pole.

~ The opposite arm and leg move forward. Plant the poles behind the feet for support.

**Instructional Techniques:**

~ Best introduced on flat terrain.

~ Demonstrate on a slope that starts gradually and becomes steeper.

~ Start students at the bottom of the hill.

**Downhill Running**

The skis are parallel, flat, and directed down the fall line, which is useful when going straight down the hill.

**Teaching Terrain:**

~ Smooth, gentle downhill terrain with a natural runout. This technique is a good way to challenge those in the class who are ready, while respecting the skier who is not.

**Body Position/Mechanics:**

~ Tell students to assume the basic athletic stance, bend the knees, and move the hands forward in front of the hips. Skiers will have to adjust this position as speed and terrain dictate. The center of gravity will become lower and the knees bend more when speed increases. With the increased knee bend, stability increases and the unevenness in the terrain is absorbed by the knees.

~ As speed increases, tell students to slide one foot slightly ahead of the other (telemark position) to help them maintain balance and increase the forward and backward support. The heels of both feet should remain on the skis.

**Instructional Techniques:**

~ At the top of the slope, spread the class so that each student makes his own track to the bottom. Be sure to provide an adequately safe runout area at the bottom.

~ After a demonstration, begin the straight run from a level area.

~ Point skis straight down the fall line and start moving with a double pole push.

~ Class control is important! Do not allow students to start a great downhill dash to the bottom.

~ Demonstrate that at the end of each straight run the student finishes the runout in the telemark glide position.

**Terrain Absorption**

A technique to maintain balance and stability over irregular terrain by flexion and extension of the legs.

**Teaching Terrain:**

~ Irregular terrain, such as dips and bumps, and changing snow conditions, such as ice, slush, packed snow, and powder.

**Body Position/Mechanics:**

- ~ Make sure that the weight is distributed over both feet.
- ~ To increase stability, hands should be held out in front of the body with the forearms parallel with the ground.
- ~ Skis may be either parallel or in the preferred telemark glide position.
- ~ Use absorption or extension so that the greater absorption occurs at the top of the bump and the greater extension occurs at the bottom of the dip.
- ~ The flexion on the bumps and extension in the dips allow the skier to absorb the force generated by the irregular terrain.

**Instructional Techniques:**

- ~ Select tracks with varying terrain and snow conditions, both in ski training and on ski marches. When students learn this skill well enough, have them practice while wearing packs with realistic loads.

## Uphill Traverse

A method to move diagonally across the fall line, gaining elevation while conserving energy.

**Teaching Terrain:**

- ~ Open slope of moderate steepness with soft snowpack that allows easy edging.

**Body Position/Mechanics:**

- ~ Angle ski edges into the hill to prevent the skis from slipping downhill.
- ~ Move arms as in the diagonal stride, shortening the uphill arm swing as the slope steepens.

**Instructional Techniques:**

- ~ On flat terrain, the instructor should review edging techniques, diagonal stride, kick turn, and the angling of the knees. Explain how the edges keep the ski from sliding downhill. The technique resembles the uphill diagonal stride, but uphill edges of the skis are kept at an angle across the slope.
- ~ A properly waxed ski that provides grip is essential. A slipping ski tires the arms because, when the ski slips, the arms must provide the support.
- ~ Practice a gradual angle across the slope to build confidence.
- ~ When planting the pole, try to keep the uphill arm from rising unnecessarily.
- ~ The hands should stay low and swing forward only high enough to plant the pole and apply pressure.

- ~ Link the traverse with a kick turn to show students how to continue traversing uphill.

- ~ A kick turn on steep slopes is secure because of ski pole support and the body facing downhill.

## Downhill Traverse

A method to move diagonally across the fall line in order to descend a slope under control and to approach a turn safely by reducing the effective slope of the hill.

**Teaching Terrain:**

- ~ On open slopes of moderate steepness with soft or loose snowpack. Since edging is easier in soft snow, powder slopes are ideal.

**Body Position/Mechanics:**

- ~ Have students practice edging by side slipping to an edge set. To do this, flatten the skis on the snow, slide downhill perpendicular to the slope, then turn the ankles and knees into the hill to set an edge and stop.
- ~ The body should assume an angled position over the skis. Angling results when the knees and hips move toward the hill and the upper body is centered over the downhill ski.
- ~ Weight the downhill ski with the uphill ski slightly ahead, freeing the hips and allowing the upper body to face downhill with less resistance.
- ~ Hold the arms and hands in front of the body about waist high, elbows flexed.
- ~ The pole baskets are behind the skier.
- ~ The weight should be distributed approximately 60 percent on the downhill ski and 40 percent on the uphill ski.

**Instructional Techniques:**

- ~ Demonstrate this technique by skiing toward and away from the class.
- ~ Explain how it is similar to the straight run.
- ~ Demonstrate by skiing at an angle across the slope with ankles turned into the hill, edging the skis.
- ~ Make sure students can stop on a gradual runout.

## Uphill Diagonal Stride

A fundamental Nordic technique for rhythmically ascending gradual to moderate slopes.



**Teaching Terrain:**

~ Gradual to moderate uphill slopes with well-defined tracks.

**Body Position/Mechanics:**

~ Timing in the uphill diagonal stride involves the coordination of movement between the arms and the legs. As in walking, the opposite arm and leg work together in a diagonally opposite direction.

~ The hand moves down as the pole is pulled and pushed off in a shorter, more vigorous motion.

~ The stride length is shortened and the tempo is increased to maintain momentum with little or no forward glide.

~ The angle of the slope requires a definite weight transfer to the forward ski while that foot is pushed slightly ahead of the knee to apply maximum pressure on the gripping ski.

~ Pushoff is quick and explosive to eliminate time spent on the stopped ski.

**Instructional Techniques:**

~ Select the proper wax and supervise its application.

~ Instruct students to use quicker and shorter movements, similar to jogging uphill.

~ The push comes from the whole foot and ends with an ankle extension. Similar to the diagonal stride, the legs contribute to the major thrust.

~ Keep the legs flexed and hips forward.

~ While maintaining the same knee angle during the glide, plant the poles farther back at an angle so that force is immediately applied to keep the gliding ski moving.

~ Even though the steepness of the hill will shorten the stride length, students should continue the glide, if possible.

~ The distance covered during the poling motion is critical to the overall stride length.

**Double Pole with a Kick**

A pushoff with one leg combined with a double pole to maintain or increase speed or change pace for recovery. This technique is developed from double poling skills.

**Teaching Terrain:**

~ Gradual downhill slopes or flat terrain with good tracks.

**Body Position/Mechanics:**

~ The arms swing forward and backward together. As the arms swing forward, plant the poles at an angle and apply pressure immediately while keeping elbows slightly flexed. Compress the larger, stronger abdominal muscles and transmit this power through the slightly flexed arms to the poles. While the arms are slightly flexed, the hand, forearm, and upper arm align with the pole shaft as pressure is applied to the pole.

~ Leg movement involves a pushoff from one ski with a complete weight transfer to the forward or gliding ski.

~ Make the pushoff with the same foot or alternate feet. For a better distribution of the workload, alternate feet.

~ The leg is flexed to supply power in the pushoff. The leg then extends. The other leg remains flexed during the glide with weight on the ball of the foot.

**Instructional Techniques:**

~ Start with double poling.

~ Continue double poling, initiating a kick with the same leg.

~ Alternate legs on subsequent practice runs.

~ Use the scooter drill (see diagonal stride) to emphasize pushoff/weight transfer.

**Wedge (Gliding and Braking)**

A technique for downhill running with skis in an "A" (convergent) position while controlling speed, maintaining stability, or providing a way to stop on a downhill run.

**Teaching Terrain:**

~ Packed, smooth, and gentle slopes that are free of bumps and obstacles.

**Body Position/Mechanics:**

~ Assume the basic athletic stance, emphasizing that the head is upright and eyes are forward.

~ The arms are slightly flexed and the forearms are parallel to the slope. Arms and hands are forward of the hips about waist high with elbows bent. Pole baskets are behind the skier.

~ Spread both ski tips into an "A" position with equal pressure on both skis. The ankles and knees control the slight edging of both skis, relative to the slope.

~ In a braking wedge, put pressure on the inside edges by turning the knees and ankles inward. Use pressure, edging, and the width of the wedge to control speed.

- ~ The legs flex more to lower the center of gravity and widen the wedge as speed decreases.
- ~ In the gliding wedge, keep the ankles and knees flexed.
- ~ Keep the skis nearly flat on the snow for momentum. Control the edges with the knees and ankles.
- ~ Slope steepness and snow conditions determine the exact amount of edging needed to maintain forward movement.
- ~ At the same time, maintain the tips a fist's width apart.

**Instructional Techniques:**

- ~ Demonstrate moving from the basic athletic stance to the wedge position on flat terrain.
- ~ On a gentle slope with a safe runout, have the students practice the gliding wedge, holding the position until they stop.
- ~ Progress from the downhill running position to a gliding wedge and back to the downhill running position.
- ~ Alternate positions while moving, emphasizing a sinking and rising motion.
- ~ Practice moving from a gliding wedge to a braking wedge and stopping at a predetermined point.

**Wedge Turn**

A technique to control speed and change direction while maintaining an "A" or wedge position.

**Teaching Terrain:**

- ~ Moderate, even, smoothly packed slopes. Packed or settled snow or light, shallow powder is best used for this practice.

**Body Position/Mechanics:**

- ~ Assume the basic athletic stance, emphasizing head upright and eyes forward. Arms are slightly flexed with forearms parallel to the slope. Arms and hands are forward of the hips about waist high and elbows are bent. Pole baskets are behind the skier.
- ~ The weight is transferred onto the turning ski (the ski on the outside of the curve) with a greater bend at the knee and ankle and with a slight sideward bend of the upper body over the turning ski.
- ~ To steer, the muscle groups in the upper leg and hip press on the inside forward edge of the weighted ski.
- ~ The edged ski skids a curved path in the snow resulting in a gradual turn.
- ~ The outside ski is edged and pressure is applied against it while the inside ski is fairly flat throughout the turn.

**Instructional Techniques:**

- ~ Demonstrate shifting weight from one ski to the other while on flat terrain and in the wedge position.
- ~ Practice a wedge turn in one direction and stop with a braking wedge. Alternate directions on successive runs.
- ~ Practice a downhill traverse, finishing with an uphill wedge.
- ~ Link wedge turns on varying terrain and snow conditions. Link wedge turns on a slalom course using student ski poles for gates.

**Wedge Christie**

To learn to transition from a wedge to a parallel turn.

**Teaching Terrain:**

- ~ Groomed easy (green) and intermediate (blue) terrain.

**Body Position/Mechanics:**

- ~ The wedge christie is similar to the wedge turn, but the skis are matched to parallel as the turn progresses. Both skis are steered from a parallel position to a wedge position. As the turn progresses, the outside leg will become more dominant and the inside leg will be turned at a slightly faster rate, causing the skis to match. Steering the inside ski is facilitated by actively rolling the ski off its inside edge to the outside edge (flattening the inside ski). The turn finishes with both skis skidding out of the fall line.
- ~ Matching of the skis occurs at different points with respect to the fall line, depending on speed, terrain, snow conditions, and competence of the skier.
- ~ Flexion and extension of all joints may involve a greater range of motion, and more pronounced weight shift due to increased speed and terrain.
- ~ No pole touch is required; hands and arms are used to balance torso over feet and legs.

**Instructional Techniques:**

- ~ Speed is slightly higher than for wedge turns.
- ~ Demonstrate single turn to one side.
- ~ Link wedge christies on varying terrain and snow conditions.
- ~ Link wedge christies on a slalom course using student ski poles for gates.

**Wedge Telemark**

To transition from a wedge to a telemark turn (not applicable with AT skis).

**Teaching Terrain:**

~ Groomed easy (green) and intermediate (blue) terrain.

**Body Position/Mechanics:**

~ The initiation of this turn is similar to the wedge christie, with the finish of the turn completed by moving into a telemark position. At turn initiation, as the old outside ski edge is released, the new outside leg twists to form a wedge. As the turn progresses, the inside ski is actively steered along with the outside ski moving from wedge to telemark. In a tall telemark stance, the feet are positioned about a boot's length apart and the skis are parallel to each other.

~ Matching of the skis occurs at different points with respect to the fall line depending on speed, terrain, snow conditions, and competence of the skier.

~ Flexion and extension of all joints may involve a greater range of motion, and more pronounced weight shift due to increased speed and terrain.

~ No pole touch is required; hands and arms are used to balance torso over feet and legs.

**Instructional Techniques:**

~ Demonstrate and practice the wedge telemark J-turns to a stop.

~ Practice to both sides.

~ Link wedge telemarks on varying terrain and snow conditions.

~ Link wedge telemarks on a slalom course, using student ski poles for gates.

**Stem Christie**

To negotiate varying conditions while carrying heavy loads.

**Teaching Terrain:**

~ Intermediate (blue) to advanced (black) terrain in varying conditions, including bumps, crud, and powder.

**Body Position/Mechanics:**

~ This turn is similar to the wedge christie, but it uses a stem move to create the initial wedge position. At turn initiation, while maintaining an edge set on the downhill ski, the new outside ski is stemmed out to form a wedge. Concurrently, a pole swing and tap will direct a movement of the center of mass toward the new turn. As the turn progresses, the outside leg will become more dominant and the inside leg will be turned at a slightly faster rate, causing the skis to match. The turn finishes with both skis skidding out of the fall line.

~ Based on conditions, the stemmed ski can be stepped out into a wedge and the inside ski can be stepped into a matched position.

**Instructional Techniques:**

~ Demonstrate and practice wedge christie J-turns to a stop.

~ Practice to both sides.

~ Practice stepping the stem out and in to both sides.

~ Practice sliding the stem out and in to both sides.

~ Demonstrate and practice up stem and down stem.

~ Link wedge christies on varying terrain and snow conditions.

~ Link wedge christies on a slalom course, using student ski poles for gates.

**Step Turn (In Motion)**

A technique to change direction by stepping the skis divergently ("V") into a new direction. The step turn controls speed, changes direction, or both and it can be used in all snow conditions.

**Teaching Terrain:**

~ Taught best on moderate downhill terrain.

**Body Position/Mechanics:**

~ Assume the basic athletic stance.

~ Project the arms and upper body slightly in the direction of the anticipated turn.

~ The tip of the inside ski is picked up and placed at a divergent angle to the other ski. The other ski is brought parallel and the process is repeated until the desired change in direction is achieved.

~ Both skis are edged to the inside of the turn; the tails are left on the snow.

~ Knees and ankles are flexed throughout the turn.

**Instructional Techniques:**

~ Have students practice static star turns around the tails.

~ From a downhill traverse, step turn out of the fall line.

~ Instruct students that they should try to have the sensation of pulling up with the toes and pressing down with the heel, much like a star turn.

~ Tell students this technique is a moving star turn.

## Skate Turn

A dynamic step turn is accomplished by pushing off an edged, divergent ski. To move through a turn while maintaining speed or accelerating.

### Teaching Terrain:

~ Flat or downhill terrain, with or without tracks, on fairly hard snow.

### Body Position/Mechanics:

~ Assume the basic athletic stance.

~ Arms and upper body are dynamically projected in the direction of the turn.

~ Legs are flexed to lower the body over the skis (pre-loading).

~ The inside ski is lifted and angled in the direction of the turn. From the weighted ski, the skier pushes off in the new direction, transferring all weight to the inside ski and gliding on it.

~ The other ski is brought parallel (matched).

~ Repeat this maneuver until the desired new direction is obtained.

### Instructional Techniques:

~ Start practicing on flat terrain.

~ Move to gentle downhill terrain.

~ Encourage students to practice in both directions.

~ Instruct students to practice several skating turns to both sides, first with the poles and then without them.

## Basic Parallel

To link parallel turns with rhythm and speed control.

### Teaching Terrain:

~ Groomed intermediate (blue) terrain. Speed is faster than for the wedge christie.

### Body Position/Mechanics:

~ At turn initiation, a pole swing and tap will time and direct a movement of the center mass toward the new turn. Skis are maintained at a hip's width stance. Tipping and twisting movements of both feet/legs occur simultaneously so that the skis are parallel throughout the turn. Pressure dominance shifts from the former outside ski to the "new" outside ski. Knee and ankle flexion develop as the turn progresses. Accurate blending of skills enhances consistent turns.

~ At initiation, a pole swing and tap will time and direct a movement of the center of mass toward the new turn.

~ Edge change (releasing and re-engaging) occurs through tipping versus pushing movements.

~ Turn shape controls speed.

~ Slightly more dynamic turns require increased range of motion.

~ Countering develops as needed, but should not be contrived.

### Instructional Techniques:

~ Use a short downhill run to parallel J-turn; do each side.

~ From a downhill traverse, release edges, steer into the fall line, and then continue steering into a J-turn and set edges.

~ Practice a static knee roll left-to-right, back and forth. Then, try narrow radius parallels, using simple knee rotation back and forth, rolling from one set of edges to the other.

~ Link turns together with and without pole plants.

~ Increase slope angle and vary snow conditions.

## Dynamic Parallel

To make parallel turns in advanced terrain in a variety of conditions.

### Teaching Terrain:

~ Intermediate (blue) to advanced (black) terrain in varying conditions, including bumps, crud, and powder. Dynamic parallel turns can be short, medium, or long radius.

### Body Position/Mechanics:

~ This turn is similar to basic parallel, but uses more external forces generated by speed and ski-snow interaction. It requires more active use of the feet and legs in edging and twisting movements and earlier edge engagement. Dominance of the outside ski also develops earlier than in basic parallel due to increased speed and more active flexing/extending movements. The center of mass is continuously and actively moved into each new turn.

~ Skier increases the range of motion.

~ More dynamic skiing requires more speed.

~ Increased edging movements maximize use of ski design. Ski design, accompanied by efficient skill blending, is used to carve and shape turns.

**Instructional Techniques:**

- ~ Link turns together with and without pole plants.
- ~ Increase slope angle and vary snow conditions.
- ~ Practice a single ski turn by picking up the inside ski at turn initiation and holding through full radius.
- ~ Practice rapid, linked, short radius turns.
- ~ Practice long, gradual, giant slalom turns.
- ~ Practice hopping parallels for turn initiation; practice hopping turn initiation at the top moguls.
- ~ Progress from hopping to jumping parallels.

**Basic Telemark**

To link telemark turns with rhythm and speed control.

**Teaching Terrain:**

- ~ Groomed intermediate (blue) terrain.

**Body Position/Mechanics:**

- ~ This turn is similar mechanically to the basic parallel but with the skier moving from one telemark turn into the next.
- ~ Both feet/legs steer actively throughout each phase of the turn so that the skis remain parallel with respect to each other throughout the turn.
- ~ Lead change occurs continuously while moving from one telemark stance through a transition to another.
- ~ Feet move past each other in unison.
- ~ Maintain equal pressure of the skis throughout the turn.
- ~ At the start and finish of the turn, balance is distributed over the whole front foot and the ball of the back foot.
- ~ At initiation, a pole swing and tap will time and direct a movement of the center of mass toward the new turn.
- ~ Edge change (releasing and reengaging) occurs through tipping versus pushing movements.
- ~ Turn shape controls speed.
- ~ Slightly more dynamic turns require increased range of motion.
- ~ Countering develops as needed, but should not be contrived.

**Instructional Techniques:**

- ~ Use telemark lead changes down a gentle fall line after static lead change practice.
- ~ Use a short downhill run to telemark J-turn; do each side.

~ From a downhill traverse, steer into a telemark J-turn and set edges.

- ~ Link turns together with and without pole plants.
- ~ Increase slope angle and vary snow conditions.
- ~ Practice a static knee roll left-to-right, back and forth; then try narrow radius telemarks using simple knee rotation back and forth, rolling from one set of edges to the other. This technique can be done by holding one telemark position and steering to both sides as a balance and edging drill.

**Stem Telemark**

To negotiate varying conditions while carrying heavy loads.

**Teaching Terrain:**

- ~ Intermediate (blue) to advanced (black) terrain in varying conditions, including bumps, crud, and powder.

**Body Position/Mechanics:**

- ~ This turn is similar to the wedge telemark, but it uses a stem move to create the initial wedge position.
- ~ At turn initiation, while maintaining an edge set on the downhill ski, the new outside ski is stemmed out to form a wedge.
- ~ Concurrently, a pole swing and tap will direct a movement of the center of mass toward the new turn.
- ~ As the turn progresses, the inside ski is actively steered along with the outside ski moving from wedge to telemark.
- ~ Based on conditions, the stemmed ski can be stepped out into a wedge and the inside ski can be stepped into a telemark position.

**Instructional Techniques:**

- ~ Demonstrate and practice stem telemark J-turns to a stop.
- ~ Practice to both sides.
- ~ Practice stepping the stem out and in to both sides.
- ~ Practice sliding the stem out and in to both sides.
- ~ Link turns on varying terrain and snow conditions.
- ~ Link turns on a slalom course using student ski poles for gates.

**Dynamic Telemark**

To make telemark turns in advanced terrain in a variety of conditions.

**Teaching Terrain:**

~ Intermediate (blue) to advanced (black) terrain in varying conditions, including bumps, crud, and powder. Dynamic telemark turns can be short, medium, or long radius.

**Body Position/Mechanics:**

~ This turn is similar to the basic telemark, but uses more external forces generated by speed and ski-snow interaction.

~ It requires more active use of the feet and legs in tipping and twisting movements and earlier edge engagement.

~ The center of mass is continuously and actively moved into each new turn.

~ Skier increases the range of motion.

~ More dynamic skiing requires more speed.

~ Increased edging movements maximize use of ski design.

~ Ski design accompanied by efficient skill blending is used to carve and shape turns.

**Instructional Techniques:**

~ Link turns on varying terrain and snow conditions.

~ Link turns on a slalom course using student ski poles for gates.

~ Demonstrate front and back pedal telemark turn initiation.

~ Use hopping telemark initiation; then jumping telemark.

~ Work timing in moguls for hops and jumps.

**Telemark Turn**

To control speed, change direction, and maintain greater stability. The telemark turn is particularly useful for descending through deep powder or broken crust. The telemark position, combined with a turn, puts the skier in a very solid position. The turn is effective both in the back country and on packed slopes. Skis remain staggered fore and aft throughout the turn. This technique is not applicable to AT skiing.

**Teaching Terrain:**

~ Moderate to steep slopes in all snow conditions.

**Body Position/Mechanics:**

~ Assume the basic athletic stance.

~ Have students assume the telemark position by flexing the knees and sliding the ski that will be the outside

ski in the turn forward until the tip of the back ski is approximately half way between the binding and shovel of the forward ski.

~ Position the front knee over the toes of that foot.

~ Bend the knee to form a right angle between the upper and lower leg.

~ Raise the back heel off the ski and support weight on the ball of the back foot.

~ Stand, trunk erect and relaxed, centered between the feet, which are approximately shoulder-width apart.

~ When turning, the upper body twists at the waist, getting ready to face downhill through the turn. In larger turns, the upper body twist is set. In short radius turns, the upper body faces downhill constantly.

~ Hands are forward, to the side, and held about waist high.

~ Initiate the turn by sinking into the telemark position, applying pressure, and steering the forward or leading ski. The rear ski should point toward the front ski.

~ The center of balance remains between the feet. The pressure on the front and rear skis depends on terrain, snow conditions, and purpose of the turn. The tightness of the turn dictates the amount of pressure applied to the leading ski. Subtle pressuring of the rear ski allows edge change and matching the skis at the end of the turn.

~ As steering diminishes, bring the trailing ski forward to the traverse position or forward in anticipation of a new turn.

**Instructional Techniques:**

~ Demonstrate as a static drill with changing of the lead ski.

~ Keep both poles planted for balance.

~ Have students practice sinking into the telemark position, alternating the lead skis.

~ When returning from the telemark position to the downhill running position, slide the new leading ski forward.

~ Resist the temptation to let the rear ski move backward.

~ Traverse into an uphill telemark. Do a single telemark turn through the fall line and traverse again.

~ Link turns together using long and short radius.

~ Use the pole plant as a timing aid at the initiation of the turn, signaling an edge and lead change.

~ Plant the pole forward and downhill of the body, turning around the pole.

~ Practice under all snow and terrain conditions.

## Obstacle Crossing

A method of crossing ditches, fences, fallen trees, streams, and crevasses while on skis, which allows skiers to continue the ski march uninterrupted without removing skis.

### Teaching Terrain:

~ As applicable.

### Body Position/Mechanics:

- ~ Assume the basic athletic stance.
- ~ Evaluate skier position. Align skis parallel to the obstacle.
- ~ Set poles to stabilize skier position with one pole placed on the far side of the obstacle. Be sure to allow enough room to place skis in the new position.
- ~ Sidestep the ski closest to the obstacle followed by the other ski.
- ~ Bring the second pole across.
- ~ Be careful and check both sides of the obstacle to see if it can support weight. If this is questionable and if the obstacle is deep or wet, a safety rope must be used.

### Instructional Techniques:

~ Subject students to manmade and natural obstacles in all types of terrain and snow conditions.

## Free Skiing

To negotiate varied and difficult terrain.

### Teaching Terrain:

~ Intermediate (blue) to advanced (black) terrain off piste (a marked run) with varying conditions.

### Body Position/Mechanics:

#### Bumps (mogul skiing)

- ~ Visualize a trajectory (the line) down the mogul run.
- ~ Keep the upper body facing down the fall line.
- ~ Maintain rhythmic fall-line turns.
- ~ Maintain continuous leg steering.
- ~ Maintain ski-to-snow contact.
- ~ Keep hands in continuous motion.

#### Steeps (skiing steep terrain)

- ~ Visualize a trajectory (the line) down the mogul run.
- ~ Vary turn tempo and shape to control speed.
- ~ Direct the upper body down the fall line.
- ~ Steer with the legs.
- ~ Initiate with a solid pole plant.
- ~ Manage pressure build-up.

#### Ice

- ~ Keep ski edges sharp.
- ~ Align self laterally to aid balance over edged skis.
- ~ Keep both skis equally weighted and pressured.
- ~ Apply pressure over the skis consistently and progressively.
- ~ Edging movements are key. Edge early or drift early!
- ~ Exploit ski design.

#### Powder (loose deep snow)

- ~ Develop tolerance for speed in deep snow.
- ~ Keep the upper body quiet and solid.
- ~ Equalize pressure over both skis.
- ~ Keep feet and legs loose and supple.
- ~ Actively steer skis in and out of turns.
- ~ Use poles to aid in rhythm and flow.

#### Crud and crust

- ~ Keep the upper body facing down the fall line.
- ~ Maintain rhythmic fall-line turns.
- ~ Ski aggressively and with a purpose.
- ~ Use leapers and hop turns.
- ~ Initiate with a solid pole plant.

#### Wet, heavy snow

- ~ Wax skis to minimize sudden grabbing of the snow.
- ~ Keep the upper body facing down the fall line.
- ~ Maintain a centered stance.
- ~ Maintain rhythmic fall line turns.

### Instructional Techniques:

~ Vary in accordance with snow condition and steepness of the slope.

# CHAPTER 6

## SKIJORING

Skijoring is the technique of towing troops on skis by vehicles. Skijoring is a swift and efficient means of transporting Marines over a snow-covered environment, but is primarily limited to snow-packed roads or trails made by tracked vehicles. Additionally, those being towed must have a basic level of skiing proficiency.

An advantage of skijoring is that less energy is expended if the technique is performed properly; however, Marines that continually fall may expend more energy by repeatedly picking themselves up. Skijoring can expedite the movement of a skiborne unit, if Marines do not slow the process by falling. A disadvantage of skijoring is that, if done improperly, it can become tiring and slow. Training is critical. Though time consuming, proper training is important for the skiers and for the drivers. Improperly trained drivers can cause serious accidents to skiers.

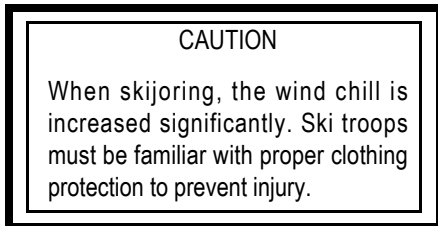

---

### Safety Requirements

---

The following safety points should be observed when skijoring:

- Never, under any circumstances, should a skier tie into a skijoring rope because this could cause the skier to be dragged over, around, or through obstacles and cause serious injuries.
- The rate of speed for a vehicle pulling experienced skiers should not exceed 25 miles per hour. For inexperienced skiers, the rate of speed should not exceed 15 miles per hour.

- Skiers should be spaced at least half a ski's length apart from the tail of the front skier to the tip of the following skier.
- A safety rider that has visual contact with the skiers and communications with the driver will always be employed. The safety rider should be experienced in skijoring. The safety rider must—
  - ◆ Be situated where he can observe all skiers.
  - ◆ Be in communication with the driver at all times, whether by using a whistle, a cord, or another person.
  - ◆ Give the halt signal for all others to hear in case anyone falls and, most importantly, so the driver knows that he must halt.
  - ◆ Have a signal that everyone knows for stopping, slowing, and accelerating.

---

### Over-the-Snow Vehicle

---

Skijoring requires the use of an over-the-snow vehicle with a sufficient towing capacity. Towing capacity is determined by the driver of the vehicle based upon the snow conditions, type of vehicle, and the safety rider's field of observation. The vehicle's driver should ensure that—

- The mirrors for the driver are in correct alignment for best viewing to the rear of the vehicle.
- The vehicle has a functional back-up horn.
- The safety rider occupies the roof hatch so he can observe the skiers.

The number of skiers skijoring will be determined by the driver or mountain leader. To prepare for skijoring, the driver or mountain leader shall—

- Find the middle of the towing rope.
- Open the trailer hitch and place an over-the-object clove hitch into it using the middle of



the towing rope, which will form two towing lines behind the vehicle. A clove hitch is the only knot used.

- Tighten down the clove hitch, replace the top of the trailer hitch, and ensure it is locked down to prevent the rope from slipping out.

## Techniques

Each skier should line up on the outside of his line. The first skiers should be at least one ski length behind the vehicle or where the safety rider can observe them. Skiers should be a half ski's length apart from each other before hooking up. See figure 6-1.

Once the interval is appropriate and the skiers are ready to hook up, the forward skiers should hook

up first, followed by the second set, and so on in sequence. To hook up, Marines must—

- Place the ski pole handgrips on top of the tow rope.
- Grasp the tow rope in front of the pole.
- Wrap the rope around the ski poles and directly under the handgrips, forming a half hitch.
- Place the ski pole baskets behind the outside armpit to use as a rest (see fig. 6-2).
- Shuffle skis when starting to prevent skis from freezing to the ground.
- Keep skis parallel, about shoulder width apart, and knees flexed in the basic ski stance.

The last skiers should ensure they keep the tension on the end of the rope to keep their ski poles in place. If a Marine falls, everyone must let go of the rope and ski outboard. The most

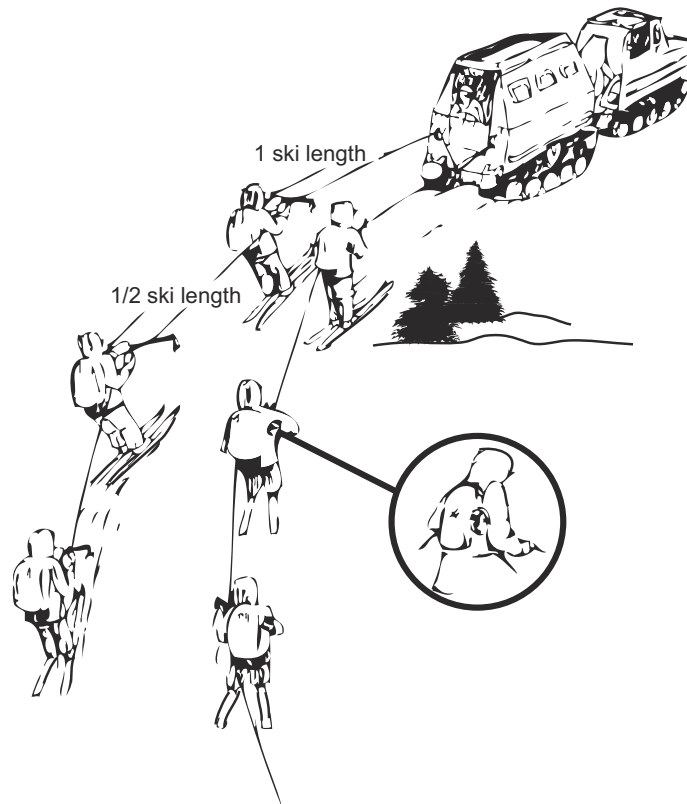

Figure 6-1. Skijoring.

experienced skiers should be in the front and back of the rope.

---

### Special Considerations

---

The following points should be considered when skijoring:

- Communication signals between the safety rider and driver must be established.
- The safety rider must be positioned to view all skijoring, start slowly with a consistent speed and stop gradually, and increase speed down gentle slopes.

- Skiers shall unhook before steep slopes. The decision to unhook for downhill grades will depend upon the skier's ability.
- Sharp turns must be avoided.
- Visibility might warrant fewer skiers.
- Deep snow may warrant fewer skiers.
- The skier's ability will dictate the speed of the vehicle.
- If sleds must be towed, they should be towed separately for safety (see fig. 6-3).
- When negotiating turns or curves, Marines should ski to the outside of the turn, especially the rear skiers on the inside rope.
- Drivers must be properly briefed.

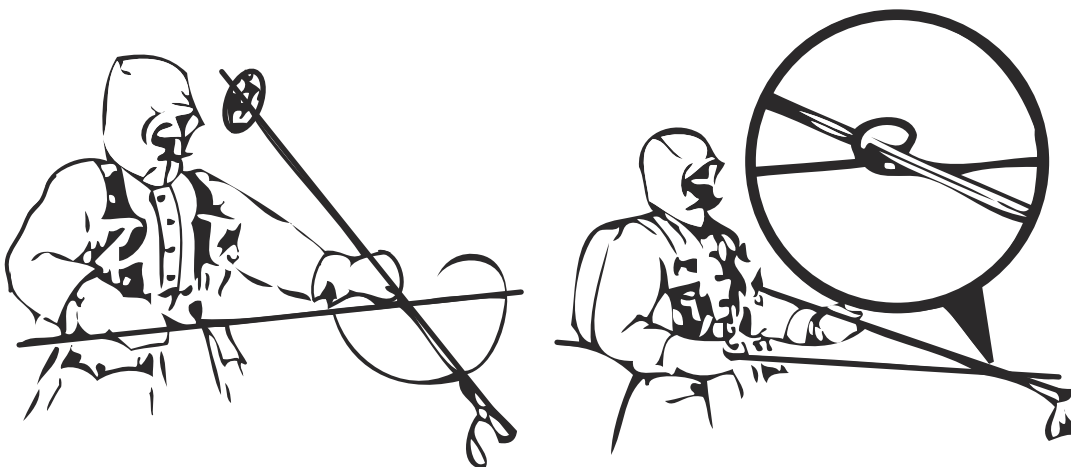

Figure 6-2. Hooking Up to Skijoring Line with Ski Poles.



Figure 6-3. Towing Sleds.

This Page Intentionally Left Blank

# CHAPTER 7

## ICE MOBILITY AND COUNTERMOBILITY

This chapter addresses ice crossing procedures and the use of ice to increase mobility, create obstacles, and impede mobility.

---

### Ice Reconnaissance

---

Whether crossing ice or using it as a road, reconnaissance is required to determine trafficability and capacity. Specific equipment and information are needed, depending on the type of ice.

#### Tools and Special Equipment Required

The equipment carried depends on availability and need. Some or all of the following equipment may be required:

- Ice measuring rod.
- Ice auger/axe bar.
- Chisel/spud.
- Ice saw.
- Weighted depth cord.
- CBRN detectors.
- Probes.
- Mine detectors (improvised explosive detector dogs, if available).
- Belay rope (*always belay the Marine conducting the ice reconnaissance*).
- Thermite grenades.
- Axe.
- Ski poles or staff.
- Demolitions.

#### Information to Measure/Gather During Ice Reconnaissance

Marines should determine the following about the ice they are considering crossing:

- Thickness of ice and its formation.
- Thickness of snow on the ice.

- Thickness of snow on the banks.
- Is there ice on banks? How is the ice attached to the banks? Does it hang over the water?
- The slope angle of banks.
- Width and depth of water.
- Current speed and slowest current area.
- Weight capacity of ice.
- Theoretical growth of ice.
- Best routes for main and secondary crossing.
- If additional work is required to affect the crossing, will it be a small or large effort?
- Is natural or artificial material available for reinforcement?

#### Crossing Route Site Selection

The best conditions for ice crossing exist where the stream is broad and straight and the bank is relatively low or has a gentle slope and is easy to prepare. It should also have an even bottom, well-defined channels, and a water flow that is reasonably deep with a low, uniform velocity. These conditions favor the formation of strong thick ice suitable for ice bridges. Of particular interest is the effect of a small stream running into the outside curve of a main stream. Observations have shown that where a main current curves at a right angle, and a secondary current enters perpendicular to or into the main current, there is a slowing of the entire water movement of that particular area. This occurrence results in freezing from bank to bank, which makes the ice capable of supporting troops on snowshoes or skis. Specific site selection considerations are—

- Designate the proposed route, approaches, exits, and sounding holes with bags, ice blocks, snow piles, stakes, or tape, depending on tactical considerations.
- Determine the width of the water obstacle.
- Determine if any dams are upstream.

- Determine tidal rise and drop for bays and the duration of high tide.
- Cut and drill holes along the axis through the ice every 3 to 5 meters by the banks and every 10 meters in the channel.
- Sketch river profiles on special engineer paper.
- Determine alternate routes.

Immediately adjacent to the shore, the ice formation is thin, weak, and more likely to develop cracks than ice in the center of a frozen stream. Depending upon the gradient of the riverbed and the thickness of the ice near the shore, it is generally safer to maintain a route near the shore if the ice rests upon the river bottom.

Where a current of water flows under a large ice area, the ice in contact with the current is subject to a greater variation in temperature; it is, therefore, thicker than the ice in adjacent areas. Marines should consider the following points:

- Shallow water ice is usually thinner than deep water ice.
- Good quality ice is clear and without bubbles and cracks. In a body of water containing clear and cloudy ice, the clear ice will frequently be thinner than the cloudy ice.
- Muskeg lakes contain a great deal of vegetation that, when decomposing, retards freezing and results in weak ice.
- Flooded snow, when frozen, produces slush ice, which is white and may contain air bubbles. Slush ice has a load-carrying capacity approximately 25 percent less than that of prime natural ice.
- During freezing weather, the thickness of ice is increased by removing its snow cover.
- Ice that remains unsupported after a drop in the water beneath it has little strength. Such types of water include reservoirs and lakes with run-offs or hydro-electric dams. In some countries, such as Norway, many rivers and lakes are controlled by flood gates and may be opened by home guard units upon attack.

- During extremely cold weather, cracks caused by contraction of the ice may be enlarged by heavy traffic.
- In spring, the main body of ice can be traveled over (if water is on the ice surface) for a limited time only. Potholes demand extra caution.
- The location of a reinforced ice crossing downstream of a summer crossing site that uses floating equipment in order to minimize the danger of damage to the bridging equipment during the thaw.
- Marines should check for mines, ice obstacles, tank traps on ice, demolitions/explosives (standard or improvised) under ice, and CBRN contamination and indicators.

## Fords

Broad flood-plains with sandbars and shifting water produce weak or unsupported ice with open water areas and difficult working conditions. Such locations will probably require a combination of an ice crossing and conventional floating bridges/winter ford. Fording streams in the winter should be avoided because of the difficulties encountered in the crossing and the effects of water on personnel and equipment when the ambient temperatures are very low. More information on seasonal fording of bodies of water can be found in MCRP 3-35.1A.

---

## Ice Breaching for Countermobility

---

Explosives or supporting arms may be required to breach ice; for example, Marines may choose this method to—

- Deny the enemy use of a frozen river or lake as an avenue of approach, landing zone, or main supply route by breaking up ice with supporting arms, which must occur regularly due to refreezing—the colder, the more frequently.
- Protect a defensive position on a lake or river line by preplanning fires on the ice and positioning machine guns for grazing fire over the ice.

- Ambush troops, vehicles, or helicopters using a frozen body of water (by grazing fire or pre-planned supporting arms).

### Ice Breaching Party

The ice breaching party is organized into three teams—reconnaissance, demolition, and initiator.

The reconnaissance team conducts an ice reconnaissance to select the appropriate site and determine the demolition requirements. It reports this information to the demolition team. Furthermore, the reconnaissance team goes ahead of the demolition team to prepare the holes in the ice by chopping, drilling, or blasting. Chopping can be done with an ice axe, pick axe, or spud bar. Drilling is done with small, tamped charges placed on the surface of the ice in a partially excavated hole. The holes should be larger than required for the main charges to pass through them. When chopping through the ice, the darker water will be seen before breaking through. The hole is then quickly cleared out to its desired diameter before the hole fills up with water. The reconnaissance team then moves off the ice.

The demolition team, having prepared the charges in a concealed position on a single detonating cord chain or with each charge individually prepared for electric detonation, brings the charges onto the ice by sled and places one charge by each hole. One team member remains with each charge and suspends the charge through the hole, using a stake to bridge the hole and hold the charge in place. The demolition team moves off the ice. In cold weather, the following points should be noted in connection with demolitions:

- At subzero temperatures, the plastic explosive (C-4) can become brittle. The preparation of charges should be done in warm surroundings if the explosive has to be molded. Trinitrotoluene (TNT) demolition blocks are a suitable alternative to C-4 due to TNT being water resistant and freeze proof; TNT, however, cannot be molded.
- Detonating cord becomes very brittle in the cold and may not explode its whole length unless all kinks or bends are removed very carefully. There should be no sharp bends or knots.
- Electric detonation by means of a series circuit is an effective alternative to using detonating cord in extreme cold weather. This type of detonating process should be used on small gaps/widths.
- The effect of a charge in snow is considerably lessened; however, when used in a pattern charge on ice, explosives are very effective.

When working with explosives and accessories, a complete sense of touch is required. Due to the cold, the preparation of explosive charges will take twice as long as normal. No Marine should work for more than 30 minutes before going into a warm tent to warm his hands. Contact gloves can increase the 30-minute period. If temperatures remain between -4 and 14 °F, a blown hole in ice will be passable for personnel in 4 days, light vehicles in 14 days, and heavier tracked vehicles in 6 weeks.

Improvising in a combat situation may be needed to accomplish a given mission. If C-4/TNT is not present, the use of other explosives, such as Bangalore torpedoes, M-15 antitank mines, and cratering charges can be used effectively. The amount of explosives needed is determined using the ice-breaching formula in fig. 7-1 on page 7-4.

If the water is more than 8 feet deep, charges should be suspended 4 feet under the ice. If the water is less than 8 feet deep, charges are suspended halfway between the ice and the bottom. The charges may have to be weighted in river currents to keep them stationary at the proper depth. The charges should be set up on a continuous detonation cord trunk line with each charge being wrapped with detonating cord and taped. This preparation ensures positive detonation and quick assembly as each charge is measured off for proper separation. The charges are suspended from the detonating cord by wrapping the cord

**Weight of Charge:**  $W = 1.4 \times T^3$  (to third power).

**Depth of Charge:**  $D = .6 \times T$

**Radius of Crater:**  $R = 6.56 \times W^{1/3}$  (to 1/3 power or the cube root).

LEGEND:

**D** depth  
**R** radius  
**T** ice thickness  
**W** pounds TNT

**Figure 7-1. Ice-Breaching Formula.**

around the stake bridging each ice hole. For this reason, the proper length between charges should be the separation distance, plus twice the suspended distance, plus 2 feet for wrapping the charge and the stake.

The initiator follows the remainder of the group, checks the charges, and initiates the charges if nonelectric blasting is being used. The time fuze should be sufficiently long to ensure that the initiator clears the ice before detonation. If electric blasting caps are used, the initiator completes the firing circuit. This method is used when detonation is time-sensitive or is to be on command at a future time, but the charges must be reexamined periodically.

### Water Obstacle Maintenance

In cold weather, the water obstacle will begin to refreeze soon after breaching. Refreezing can be delayed by removing the shattered blocks of ice from the water or pushing them under the downstream ice in a river. The open water can then be covered with a tarpaulin or plastic to insulate it from the colder air and inhibit ice formation.

When examining the obstacle after breaching, Marines should avoid large sympathetic cracks, which may have opened nearby.

### Ice Ambushes

There is sometimes a need to blow up ice without marking the snow on top of it. Ambush sites are typical of this requirement and may be done by employing the following technique:

- Near the bank, remove a section of ice one meter in diameter.
- Cut a number of saplings up to 10 meters tall and trim the branches.
- Attach explosives to these saplings and connect the detonator cord.
- Slide saplings through the hole in the ice with their explosives attached.
- Lash the end of one sapling to the front of the next until the length of ice, which is to be blown, is covered. The charges will be kept afloat and flush against the ice through the buoyancy of the saplings. The water provides the tamping.
- Blow the charge from the bank, as required.

## CHAPTER 8

# OVER-THE-SNOW CASUALTY EVACUATION

Detailed CASEVAC/medical evacuation planning enables mission accomplishment for the unit. Depending on the type of injury and the environmental/terrain conditions, moving a casualty from the point of injury to the collection point may require the Marine's entire squad and take significant time. Such movement not only endangers the mission, but can be deadly for the patient. Realistic and detailed planning must be conducted and should include preplanned collection points and movement routes, extraction points, alternate transportation options, and

availability of appropriate types of litters (equipment). Leaders must ensure the CASEVAC plan is supportable at all levels.

There are two types of standard litters for over-the-snow CASEVAC: the team sled, which is the current fire team sled in the Marine Corps supply system, and the large sled. There are two large sleds in the system: the old ahkio and new weapons/CASEVAC variant of the team sled. Detailed information on over-the-snow CASEVAC can be found in MCRP 3-35.1A.



This Page Intentionally Left Blank

# CHAPTER 9

## OVER-THE-SNOW VEHICLES

### BV-206 Small Unit Support Vehicle

The BV-206 small unit support vehicle (SUSV) is a tracked vehicle designed for use in marginal terrain, mud, or sand and in a mountain/cold weather environment. It has two, track-driven cars made of reinforced fiberglass and four interchangeable tracks that drive full time. The front car carries four passengers and contains the engine, transmission, steering, braking, and transfer system. There are four different variants of the SUSV; however, the maintenance and operating characteristics do not differ significantly between the vehicles. The four variants are—

- Carrier, Cargo: tracked, 1½ ton, M973A1 (personnel carrier).
- Carrier, Cargo: tracked, 2 ton, M1067 (cargo carrier).
- Carrier, Command post: tracked, 1½ ton.
- Carrier, Ambulance: tracked, 1½ ton.

The SUSV is a versatile vehicle that is used by armed forces throughout the world. Its track system allows it to travel in any terrain or weather

condition. It can traverse a 35-degree slope and climb up to 35 degrees. It is maneuverable and can easily negotiate narrow roads usually found in a mountainous environment. Typical uphill speeds vary from 5 to 15 kilometers (3 to 9 miles) per hour, depending on the grade and if towing another vehicle. It is also possible to pull skiers (skijoring) behind the vehicle. The BV-206 steering system limitations (see fig. 9-1) are as follows:

- Maximum height differential between front and rear wagons is 22 centimeters (8.7 inches).
- Maximum possible level angle between front and rear wagon is 17 degrees.
- Maximum turn angle (level) between the front and rear car is 34 degrees between the front and rear wagons.
- Maximum roll angle between the front and rear wagon is 40 degrees from the horizontal.

Although the Marine Corps does not have any SUSVs configured to carry crew-served weapons, the cargo carrier can be adapted to support crew-served operations. However, because the skin of the vehicle is made of reinforced fiberglass, extreme care should be used if the passenger

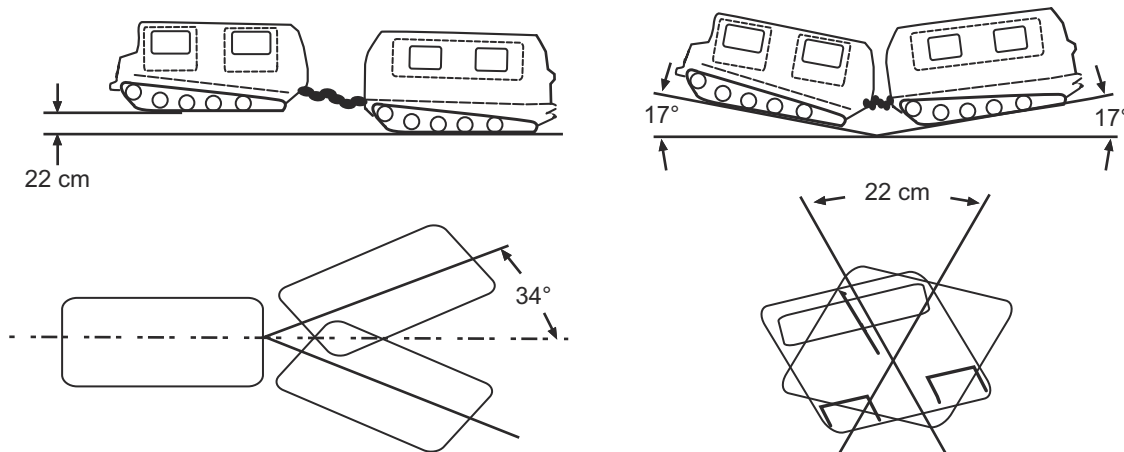

Figure 9-1. BV-206 Steering System Limitations.

variant is used as a firing platform because a weapon's recoil can cause serious damage to the vehicle. Also, since the vehicle has a thin skin, it should not be used in a support-by-fire role unless the vehicle is placed in a fortified position.

The SUSV uses a 6-cylinder, turbocharged diesel engine. The proper fluid for the SUSV engine is 15W-40 engine oil. There are three gears in the engine—high, neutral, and low. When operating in a mountainous environment, low gear should be employed; the proper way to shift the transfer is with the engine on and the transmission in neutral.

---

### **BVS-10 Viking**

---

The BVS-10 (see fig. 9-2) is similar to, but distinct from, the BV-206. It is much larger, faster, more powerful, fully amphibious, armored, and capable of mounting weapons. While not currently in the inventory of the US Military, the Viking is in service with some NATO countries.

---

### **Snowmobiles**

---

A snowmobile—also known in some places as a snow machine, sled, skimobile, or Ski-doo—is a

land vehicle for travel on snow. Designed to be operated on snow and ice, they require no road trail. While little training is required, a skilled operator can increase the capability based on experience. Design variations enable some machines to operate in deep snow or forests; most are used on open terrain, including frozen lakes, or driven on paths or trails. Usually built to accommodate a driver and perhaps one adult passenger, they are all-terrain vehicles intended for use on snow-covered ground and frozen ponds and waterways. They have no enclosure other than a windshield and the engine normally drives a continuous track at the rear; skis at the front provide directional control.

The snowmobile is a versatile vehicle that is used by armed forces throughout the world. Its track and ski systems allow it to travel in snow-covered terrain. It can traverse a 35-degree slope and climb up to 35 degrees. It is very maneuverable and can easily negotiate narrow roads or travel off-road in a mountainous environment. Typical speeds vary from 40 to 65 miles per hour depending on local regulations, the grade, snow depth, and if towing another vehicle or skiers. It is also possible to pull skiers (skijoring) behind the vehicle. The snowmobile, due to its maneuverability and speed, is most often used by scout units or for messenger communications.



**Figure 9-2. BVS-10 Viking.**

# CHAPTER 10

## SKIBORNE FIRING POSITIONS

Extreme terrain and weather can pose significant problems and are important planning considerations for both maneuver and fire support operations. In many cases, the terrain favors the defender who controls the heights. Offensive operations are usually battles for this key terrain or the chokepoints controlled in the valleys. Consequently, dismounted infantry and air operations are most suitable for this type of terrain, especially if they are properly supported by fires. For example, it is important to position mortars and artillery in defilade to increase their survivability. Yet, such terrain is often subject to snowslides, rockslides, or avalanches, which can fall on a Marine's position with devastating results. Therefore, intelligence estimates should identify defilade positions that pose the least amount of risk to these hazards.

These same types of positions are sought by enemy units and that is why observed indirect fires are so crucial to success in a winter environment. Indirect fires can impede the enemy's mobility or destroy positions, giving maneuver elements time to close with and destroy the enemy. While the basic tactical principles for artillery remain valid in mountains, they are subject to the limitations imposed by terrain and weather. See MCWP 3-35.1 and MCRP 3-35.1A for fire support and small arms considerations.

---

### The Effects of Deep Snow

---

Conducting an assault takes on a totally new dimension in deep snow. Snow hides objects, such as rocks and depressions, that provide cover and concealment and slows down the assaulting troops, making them a much easier target. Fire superiority is a problem if the unit must change into snowshoes. (Some form of flotation is needed to help troops move as fast as possible.

The best flotation device is a snowshoe.) Initially, units must maintain a high volume of fires and then shift to the sustained rate of fire. Commanders should have a battle drill for maintaining fire superiority, such as an odd/even system within the buddy team so that units can maintain fire superiority while changing into snowshoes.

Deep snow provides many problems for troops firing a rifle. A Marine who executes the standard drop from a standing position into a prone position would find his elbow, face, and rifle muzzle buried in the snow. Standard firing positions must be modified.

Marines should remember that skis or snowshoes restrict the ability to rotate the body; right-handed shooters will have difficulty firing to the right and left-handed shooters will have difficulty firing to the left. Both shooters will be restricted shooting uphill. The ideal position for setting an ambush would be on the right, uphill of a column moving on skis, because most Marines are right-handed. Route selection with longer traverses (keeping the left side of right handed shooters uphill) would give the right-handed shooters more range. In deep snow, firing Marines should—

- Sit between the skis for a stable nonmoving position, when skiing downhill in the wedge.
- Use ski poles for offhand firing as a long range firing position; otherwise, use a more stable position, such as kneeling or prone. Extra steps to remove the ski poles, cross them, and assume the firing position is time consuming and may not be practical for short range shooting.
- Face downhill and sit uphill of one's skis (as in a controlled fall position) or snowshoes if fired on while traversing downhill.
- Face uphill and kneel if traversing and fired on from the uphill side. On flat or gentle terrain, the kneeling position is sometimes unstable if the skis are not edged into the snow.

---

## Rifle Carries

---

### Carry 1

To use carry 1 (see fig. 10-1), Marines must—

- Attach the sling to the rear sling mount and around the front slip ring. The sling goes over the shooter's head. The weapon hangs down the firing side (the right side of a right-handed Marine or the left side of a left-handed Marine).
- Place the magazine pouch and canteen on the cartridge belt (load bearing vest) so that the rifle may be placed along the hip.
- Place the entrenching tool (E-tool) on the opposite side of the rifle when the pack is worn.

The butt of the rifle is behind the shoulder with the pistol grip to the rear so the rifle or pistol grip will not be forced under the armpit if a fall occurs.

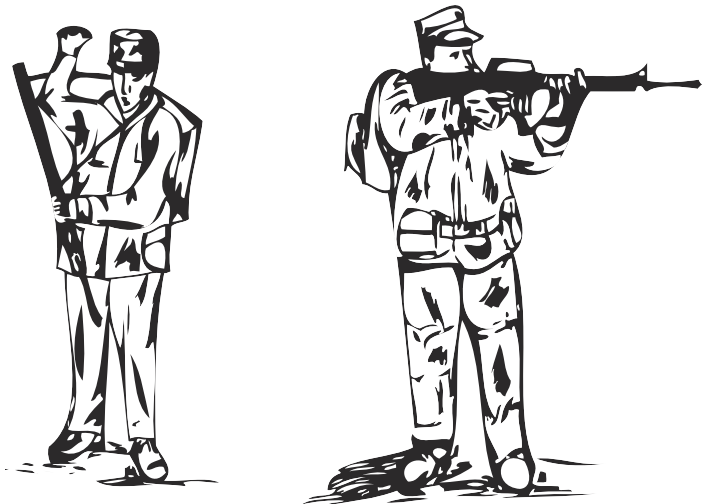

**Figure 10-1. Carry 1.**

### Carry 2

To use carry 2 (see fig. 10-2), Marines must—

- Attach the sling to the rear sling mount and around the front slip ring. The sling goes over the shooter's head. The weapon hangs down the firing side (the right side of a right-handed Marine or the left side of a left-handed Marine).
- Carry the rifle diagonally across the front (chest to waist).
- Place the sling around the neck and shooting shoulder. The magazine well is facing upward for easy access in magazine changes.



**Figure 10-2. Carry 2.**

---

## Ski Crawls

---

Ski crawls—working forward or advancing by sliding, crouching, or with trailing skis—enable Marines to move into firing positions in various types of snow. Firing positions with skis or snowshoes are discussed in MCRP 3-35.1A.

### Working Forward on Skis

Marines should use this technique in *moderate* snow during a meeting engagement or as an immediate action when there is no time to remove their skis. They must—

- Keep poles together flat on the ground at the Marine's side.
- Rise from the prone position and support oneself on the left knee.
- Hold the rifle vertically with the right hand and give more support by leaning with the left hand on the poles.
- Draw up the right foot, set the right ski in the desired direction, and advance in a crouching position while pushing oneself along with the rifle and poles.
- While working forward, keep the rifle in the right hand and the poles in the left. Reverse this positioning for left-handed Marines. See figure 10-3 on page 10-4.

### Advancing by Sliding

Marines should use this technique in *moderate* snow that will support them and their equipment. They must—

- Place poles on the skis with the handles under the bindings and the baskets over the ski tips.
- Sling the rifle over the shoulder or lay it on the skis in front of the Marine. See figure 10-4 on page 10-5.
- When sliding forward in a prone position, place skis close together, lie on the stomach on the bindings, and slide forward by pushing with the hands or toes.

### Advancing in a Crouching Form

Marines should use this technique in *deep* or *loose* snow by running in a crouched position. They must—

- Sling the rifle horizontally in front, around the neck, or over the back, depending on the situation.
- Place skis parallel on the ground, separated by the width of the Marine's body.
- Place pole baskets on the skis, running the poles under the toe straps.
- Bend low and run, while grasping the bindings and poles together for support. See figure 10-5 on page 10-5.
- Get on elbows and knees and push forward with the knees if the ground and the combat situation do not permit this method of advancing.
- Move skis forward one at a time alternately with the hands.

### Advancing with Trailing Skis

Marines should use this technique in *shallow* snow. They must—

- Trail skis while walking or rushing.
- Attach them to the waist with a cord through the holes in the ski tips.
- Carry poles in one hand and the rifle in the other or on the back. See figure 10-6 on page 10-5.

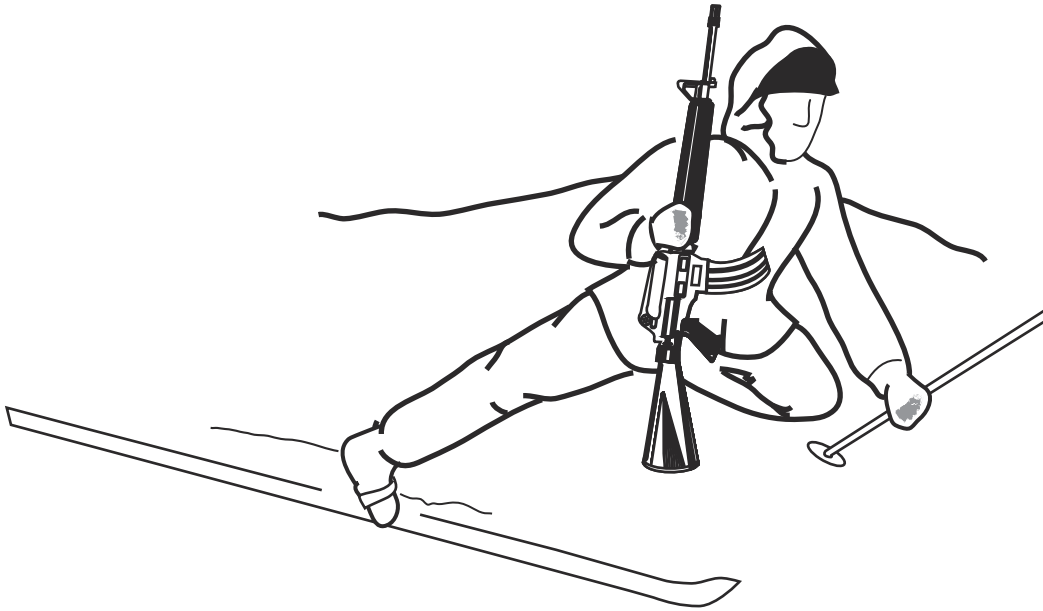

Rise from the Prone

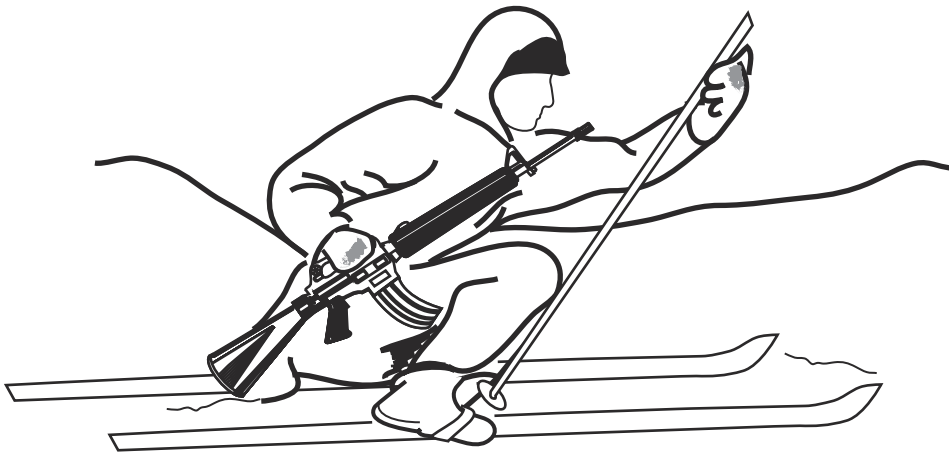

Push with Rifle and Poles

**Figure 10-3. Working Forward on Skis.**



Figure 10-4. Advance by Sliding.

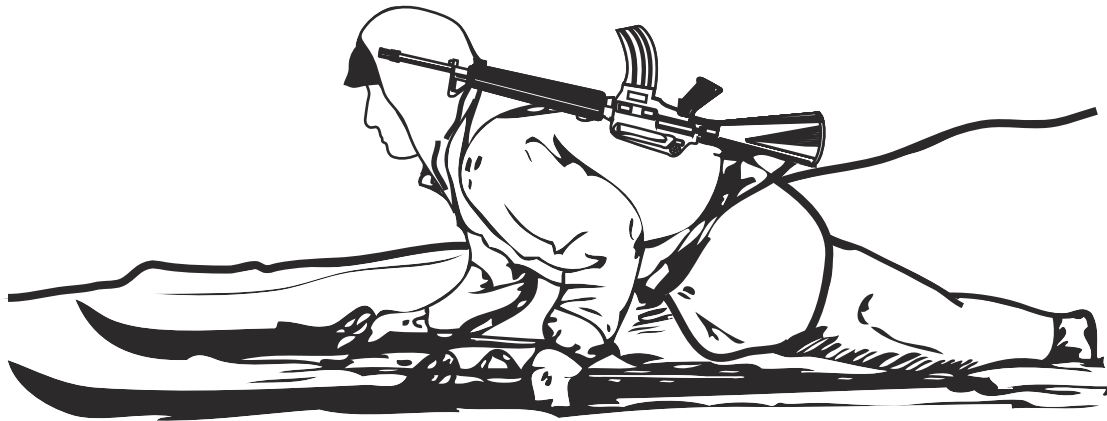

Figure 10-5. Advancing in a Crouching Form.

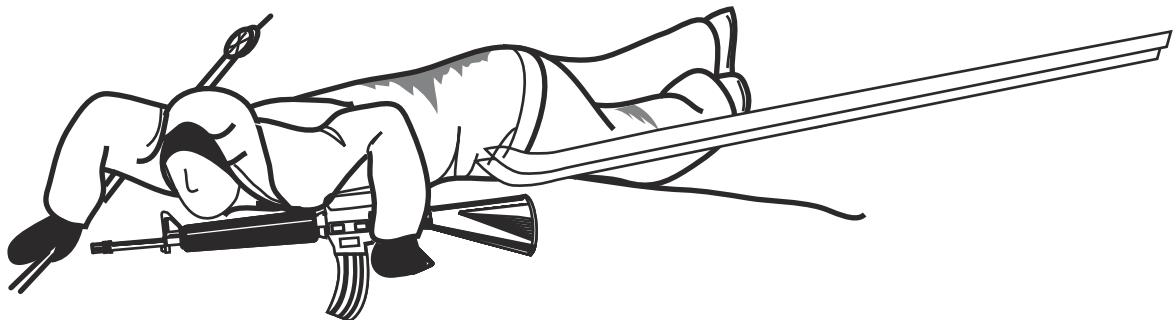

Figure 10-6. Advancing with Trail Skis.



This Page Intentionally Left Blank

# CHAPTER 11

## SNOW SHELTERS

---

### Basic Characteristics for Shelters

---

Any shelter, including snow shelters, must meet six basic characteristics to be safe and effective—

- *Protection from the elements.* The shelter must provide protection from rain, snow, wind, and sun.
- *Heat retention.* It must have some type of insulation to retain heat and prevent wasting fuel.
- *Ventilation.* Ventilation must be constructed, especially if burning fuel for heat, to prevent the accumulation of carbon monoxide. Ventilation is also needed for carbon dioxide given off when breathing.
- *Drying facility.* A drying facility must be constructed to dry wet clothes.
- *Free from natural hazards.* Shelters should not be built in areas of avalanche hazards, under rock fall, or near dead trees that have the potential to fall on the shelter.
- *Stable.* Shelters must be constructed to withstand the pressures exerted by severe weather.

---

### Snow Shelter Types

---

There are many types of snow shelters, such as—

- Snow wall.
- Snow cave.
- Tree-pit snow shelter.
- Fallen tree bivouac.
- Snow trench.

- A-frame shelter (see MCRP 3-35.1C, *Mountain Leader's Guide to Mountain Warfare Operations* [currently under development]).
- Snow coffin.

Table 11-1 can be used as a general guideline to determine which shelter to construct.

**Table 11-1. Recommended Shelters.**

Snow Pack	Snow Depth	Estimated Hours to Construct	Recommended Shelter
Loose	< 2 feet	2	A-frame
Compacted	4-6 feet	2-3	Snow coffin
Compacted	> 6 feet	3	Snow cave
Iced	N/A	2-3	Snow trench
N/A	N/A	1-2	Fallen tree
N/A	> 4 feet	1-2	Tree-pit
N/A	> 2 feet	.5	Snow wall
Legend: N/A not applicable			

### Snow Wall

The snow wall (see fig. 11-1 on page 11-2) is an extremely expedient shelter for one or two men. This shelter is constructed when the elements will not afford time to construct a better shelter. To construct a snow wall—

- Determine wind direction.
- Construct a wall of compacted snow in the shape of a horseshoe to shield Marines from the wind. The wall should be at least 3 feet high and as long as the body.

A poncho or tarp can be attached to the top of the wall with the other end secured to the ground for added protection. Skis, poles, branches, and equipment can be used for added stability.

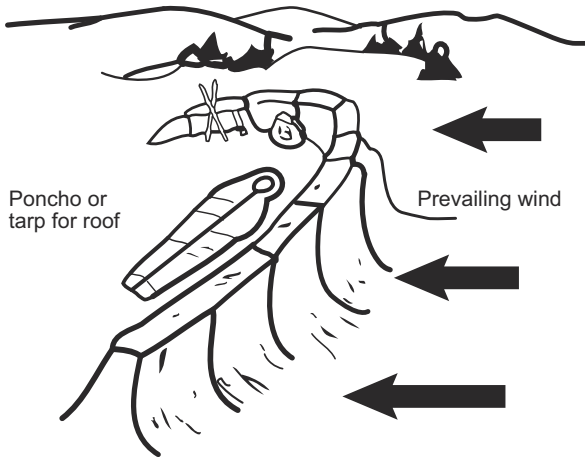

**Figure 11-1. Snow Wall.**

### Snow Cave

A snow cave is used to shelter 1 to 16 men for extended periods. There must be a well-compacted snow base of at least 6 feet to construct one. To construct a snow cave—

- Dig down into the snow until the desired tunnel entrance has been reached.
- Place all excavated snow on top of the shelter for added strength.
- Cut an entrance opening into the snow approximately 3 feet by 3 feet.
- Continue to dig out cave while removing excess snow out of the entrance. Shape the roof into a dome. If a bluish color appears through the snow in the roof, stop. There is not enough snow to support the roof.
- Create a cooking/working shelf and a sleeping bench inside the shelter.
- Dig a ventilation hole through the roof at a 45-degree angle above the entrance. A ski pole or branch is left in the hole to mark the hole and allow clearing should the ventilation hole become clogged. A pine bough branch can be placed into the outside of the roof above the hole, to aid in keeping the hole clear during falling snow.

During the day and at night there should always be an arctic sentry posted for safety in case the cave collapses.

Personnel will perspire while digging inside the cave. They should wear a minimum amount of clothing with a protective layer. Once the cave has been dug, the entrance hole must be filled in with snow block. Loose snow should be packed in between the cracks and allowed to harden for approximately 2 to 3 hours, weather dependent. After the snow has hardened, a small entrance hole can be cut. Packs, a poncho, or snow blocks can also be used to block the entrance to the cave. See figure 11-2.

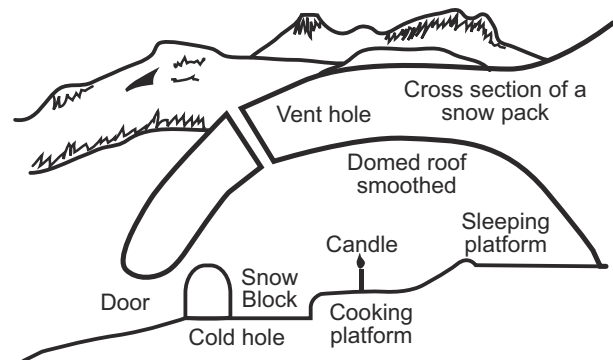

**Figure 11-2. Snow Cave.**

Snow caves can be heated by a candle, which will raise the inside temperature approximately 2 °F. If a candle is left burning while individuals sleep, a fire watch must remain posted to reduce the danger of asphyxiation. Burning stoves to heat a cave will cause the snow to melt and should be avoided.

### Tree-Pit Snow Shelter

A tree-pit snow shelter (see fig. 11-3) is designed for one to three men for short periods. It provides excellent overhead cover and concealment and should be used as observation posts. To construct a tree-pit snow shelter—

- Locate a tree with bushy branches that provides overhead cover.
- Dig out the snow around the tree trunk until reaching the depth and diameter desired or until reaching the ground.

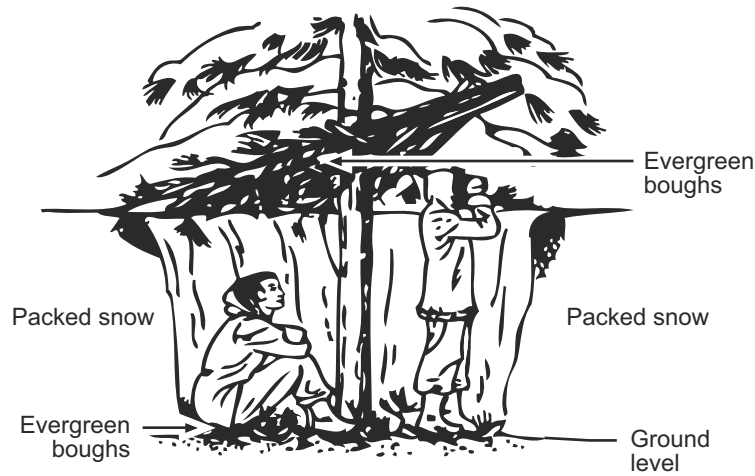

**Figure 11-3. Tree-Pit Shelter.**

- Find and cut other evergreen boughs. Place them over the top of the pit for additional concealment. Do not use a bough from the position's tree.
- Place evergreen boughs in the bottom of the pit for insulation.

**Fallen Tree Bivouac**

The fallen tree bivouac is an excellent shelter because most of the work has already been done. To construct a fallen tree bivouac—

- Ensure the tree is stable before constructing.
- Cut away branches on the underside and dig out snow, making it hollow underneath.
- Place additional snow and insulating material on the top and sides of the tree.
- Build a small fire outside of the shelter.

**Snow Trench**

A snow trench (see fig. 11-4) is a short-term shelter used on extremely hard packed snow and when trees or building materials are not available, such as in alpine and glacier environments.

Blocks of snow or ice are cut and placed to build this shelter. To construct a snow trench—

- Orient the trench so that the wind blows from the foot side to minimize snow erosion.
- Place a triangular key block vertically at the foot end of the trench to serve as the end support of the roof.

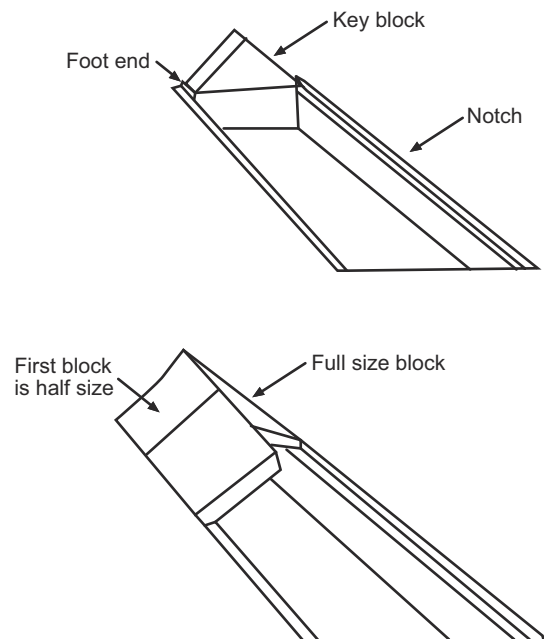

**Figure 11-4. Snow Trench.**

- Cut a notch along the inside wall of the trench. The size and width of this notch depends upon the condition of the snow. Weak snow would require a larger notch.
- Trim the roof blocks at an angle so that the tops meet at a point. The first roof block is a half block in width. This construction keeps the joint lines of the other blocks from meeting and producing a weakness in the roof.
- Inspect trench daily to avoid a collapse of the roof during a whiteout.

### Snow Coffin

A snow coffin (see fig. 11-5) is built for one to four men for extended periods. It is a variation of the snow trench and A-frame, which requires at least 4 feet of compacted snow. To construct a snow coffin—

- Dig a trench into the snow approximately 3 feet wide, 8 to 12 feet long, and 4 feet deep.
- Dig a cold hole into the floor of the trench and sleeping platforms (coffins) off the sides of the trench.
- Cover the top of the trench for added protection with either an A-frame or poncho/tarp.

### Construction of Snow Shelters

The general considerations for constructing snow shelters are—

- Building appropriately for a group's size.
- Improving heat retention with a low silhouette and reduced living area.
- Avoiding exposed hilltops, valley floors, moist ground, and avalanche paths.
- Creating a thermal shelter by applying snow, if available, to roof and sides of the shelter.
- Locating in the vicinity of firewood, water, and signaling, if necessary.
- Determining time and effort needed to build the shelter.
- Determining if the shelter can adequately protect Marines from the elements.
- Providing concealment from enemy observation.
- Planning escape routes.

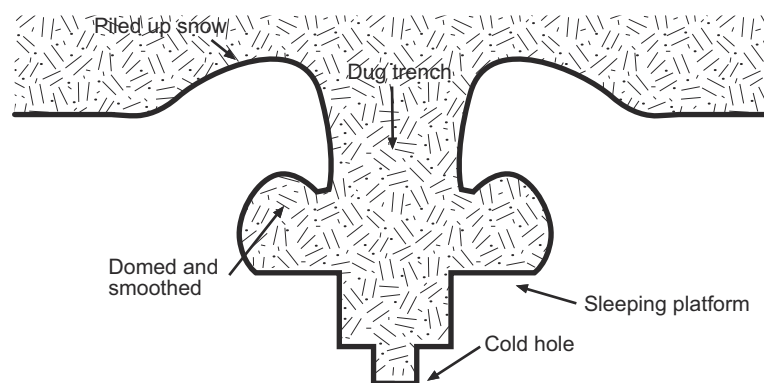

Figure 11-5. Snow Coffin.

# CHAPTER 12

## TRAINING

There is currently no secondary military occupational specialty for military mountaineers of any type or skill set. Winter mountain leaders can be identified by the school code M7B and scout skiers by HB4. The specific skills of the winter mountain leader and scout skier are force multipliers for units conducting mountain warfare operations. Understanding these skill set capabilities is important to the unit leader. Commanders can identify trained personnel by school codes, except scout skiers. Winter mountain leaders are able to train scout skiers, as needed.

---

### Winter Mountain Leaders (M7B)

---

The winter mountain leaders (M7B) are the unit's subject matter experts for operations in cold weather and on snow-covered terrain. Their knowledge of cold weather and over-the-snow mobility tactics, techniques, and procedures will enable enhanced movement, control of fires, intelligence gathering, sustainment, and force protection in complex, snow-covered terrain that is inaccessible to untrained Marines.

Winter mountain leaders are proficient in avalanche hazard assessment, crossing avalanche-prone slopes, avalanche rescue procedures, over-the-snow mobility (to include being basic ski instructors), survivability, snow bivouac routine, defensive positions of snow and ice, use/care/maintenance of cold weather clothing and equipment, over-the-snow patrol techniques, navigation, route planning/selection, tactical considerations, weapons employment, and fire support considerations. They have the necessary skills to plan, organize, and lead over-the-snow/cold weather operations; to act as scout skier element leaders on ridgeline flank security, picketing, and reconnaissance patrols; to train personnel

performing ISR missions to train their units for over-the-snow/cold weather operations; and to advise Marine air-ground task force element commanders and staffs.

Two winter mountain leaders per rifle company are recommended; three per reconnaissance company are recommended for a reconnaissance battalion; two per team for United States Marine Corps Forces, Special Operations Commands; and two per scout sniper platoon are recommended. A Marine that has been through both seasonal mountain leader courses (M7A and M7B) has the knowledge and skills to operate in all types of mountainous terrain and weather conditions, such as high to very high altitude, wet/dry/extreme cold, and rock-/snow-/ice-covered slopes to vertical. He is able to train and lead small units in disaggregated operations over complex, compartmentalized terrain that would otherwise be inaccessible to the unit commander and is likely the most experienced mountain leader within the unit.

---

### Scout Skiers (HB4)

---

Regular personnel will be on snowshoes, but mobility is slow and steep terrain is a limitation to snowshoes. Therefore, some personnel performing ISR and other related missions are trained in military skiing and become scout skiers. Scout skiers enable mountain picketing in snow-covered terrain and provide the unit commander with eyes and ears on top of and along ridgeline crests in snow-covered terrain.

Their skills include skiborne operations; tracking/countertracking in snow; cold weather long range patrols; winter survival; avalanche assessment/

avoidance; mountain communications; and calling/adjusting supporting arms in snow-covered, compartmented terrain. All ISR personnel and either one squad per platoon or one platoon per rifle company are recommended as scout skiers in order to provide sufficient security throughout

snow-covered, complex, compartmentalized, mountainous areas of operations. A ski company concept may also be used, as the commander determines necessary. For example, the battalion commander may assign an infantry company to be the scout skiers for the battalion.

# APPENDIX A

## AVALANCHE DECISION-MAKING CHECKLIST

Current Danger Rating	Low (Green)	Moderate (Yellow)	Considerable (Orange)	High/Extreme (Red)
Danger Trend/Forecast	Improving/Steady	Rising Slowly	Rising Rapidly	
Continue? If yes, proceed to avalanche activity data:				
When:	Past	Recent	Current	Current +
Number:	None/few	Many	Widespread	widespread +
Where:	Far away	In area	Your position	your position +
Triggers:	Large	Human	Human/natural	human/natural +
Characteristics:	Small	Medium/slabs	Large	large
Continue? If yes, proceed to snowpack data:				
Average depth:	>2.0 m	1.5–2.0 m	<1.5 m	
Average strength:	Strong	Moderate	Weak	
Variability from average depth/strength:	Uniform	Somewhat variable	Highly variable	
Strong over weak layering:	Little/none	Some	Pronounced	
Compression tests/ Rutschblock tests:	CT 30+ RB 7	CT 20–30 RB 5–6	CT 10–20 RB 3–4	CT 0–10 RB 1–2
Danger signs (cracking, whumping):	Few/None Heavy trigger Localized propagation	Isolated Medium trigger Moderate propagation	Widespread Light trigger Wide propagation	
Continue? If yes, proceed to weather data:				
Storm:	None	Snow 1–2 cm/hr Winds move little snow in start zone Cool and steady temps	Snow 2–3 cm/hr Winds move some snow in start zone Warm temperatures/rapid temperature rise	Snow 3+ cm/hr + Winds move much snow in start zone + Very warm temperatures/rapid temperature rise
Last NO GO storm ended:	>48 hrs ago	36–48 hrs ago	<36 hrs ago	
New snow (12 hrs):	<15 cm	15–30 cm	>30 cm	
Blowing snow:	None	Some recently	Much recently or currently	
Temperature: Solar radiation:	Cold–Cool/ None–Little	Cool–Warm/Some	≥0°/rapid rise/strong	
Continue? If yes, proceed to terrain assessment:				
Incline:	<25	25–35	>35	
Wind exposure/aspect:	Windward	Some cross/lee	Much cross/lee	
Trigger points:	None–Few	Some	Many	
Size/traps:	Small/None–Few	Moderate/some	Large/many	



Current Danger Rating	Low (Green)	Moderate (Yellow)	Considerable (Orange)	High/Extreme (Red)
Other Pertinent Data:				
	GO with normal caution  Consider human factors	Consider safer options  GO with increased caution  Consider human factors	Consider safest options  Travel not recommended on specific terrain or certain snowpacks  Consider human factors	Travel not recommended  Consider human factors
Discussion of decision (terrain/snowpack to avoid, human factors):				
Legend: cm centimeter CT compression test > greater than ≥ greater than or equal to hr(s) hour(s) < less than m meter(s) RB rutschblock test				

# APPENDIX B

## AVALANCHE DATA OBSERVATION CHECKLIST

Data Class	Information Category	Observations Made	Red Flag Values	Current Observation	
<b>Weather</b>	Precipitation	Type	Rain/heavy wet snow		
		Intensity	>3 cm (1 in)/hour		
		Accumulation	>30 cm (12 in)/12 hours		
	Wind	Speed	Strong enough to move snow		
		Direction	Moving snow onto/across terrain where Marines will travel		
		Duration	Long		
		Temperature	Current	$\geq 0^{\circ}$ C/32 $^{\circ}$ F	
			Maximum/minimum	$\geq 0^{\circ}$ C/32 $^{\circ}$ F	
			Trends	Rapid changes (especially from cold to warm, and through the freezing level)	
	Solar radiation	Cloud cover	Allowing a lot of radiation to enter or intensifying radiation		
		Intensity	Strong		
		Duration	Long		
	<b>Snow pack</b>	Snow cover	Height	<1.5 m/5 ft	
Strength			Weak		
Variability			High		
Layers		Strength	Strong over weak		
		Temperature	Near/equal to $0^{\circ}$ C/32 $^{\circ}$ F		
		Grain characteristic	Large, loosely packed, angular		
		Bonding	Strength	Compression test $\leq 20$ Rutschblock $\leq 4$	
			Plane characteristic	Smooth, clean	
			Failure layer	Large, loosely packed, angular grains	
Booming or whumping		Initiation	Natural/human trigger		
		Propagation	Far (>3 m/10 ft)		
		Extent	Widespread		
<b>Avalanche activity</b>		When	Current	Observed	
	Recent		<24 hours (maritime climate)  <48 hours (continental climate)		
	Past		If condition still exists		

	Where	Area	Widespread	
		Slope angle	More than 30°	
		Slope aspect	Facing sun Leeward	
		Slope shape	Concave	
		Terrain traps	Traps exist where avalanches are running	
	What	Natural triggers	All natural triggers	
		Human triggers	All human triggers	
		Other triggers	Remote triggers, artillery, demolition	
	How	Destructive potential	≥Class 2	
		Propagation	Wide fracture lines running far	
		Failure layer	Large, loosely packed, angular grains	

Legend:  
 C centigrade  
 cm centimeter  
 ° degrees  
 ft foot/feet  
 > greater than  
 ≥ greater than or equal to  
 in inch(es)  
 < less than  
 ≤ less than or equal to  
 m meter(s)

# GLOSSARY

## SECTION I. ACRONYMS AND ABBREVIATIONS

AT . . . . .	alpine touring	MCCWIK . . . . .	Marine Corps Cold Weather Infantry Kit
CASEVAC . . . . .	casualty evacuation	MCRP . . . . .	Marine Corps reference publication
CBRN . . . . .	chemical, biological, radiological, and nuclear	MCWP . . . . .	Marine Corps warfighting publication
°F . . . . .	degrees Fahrenheit	NATO . . . . .	North Atlantic Treaty Organization
ISR . . . . .	intelligence, surveillance, and reconnaissance	SUSV . . . . .	small unit support vehicle
		TNT . . . . .	trinitrotoluene

## SECTION II. DEFINITIONS

**absorption**—Adjusting the magnitude of pressure/compression by vertical displacements of the body mass through flexion and extension of hips, knees, and ankles.

**angling**—Moving in the diagonal/lateral planes of the body in a flexing or extending manner.

**anticipation**—Movement to prepare for turning or traversing, during which the upper and lower body are brought into a twisting relationship. With the torso and legs twisted, the hips play the intermediary role.

**balancing**—The action of maintaining equilibrium, both in movement and while static.

**basic athletic stance**—A neutral stance with the balance over the center of the whole foot and both skis evenly weighted.

**basic parallel**—A technique where, at turn initiation, a pole swing and tap will time and direct a movement of the center mass toward a new turn.

**basic telemark**—A technique similar mechanically to the basic parallel, but with the skier moving from one telemark turn into the next.

**blocking**—The action performed in the initiation phase of a turn; the momentary stabilizing of the torso through pole contact with the snow.

**controlled fall**—A method of safely stopping after losing control.

**diagonal stride**—The fundamental Nordic technique for flat or slightly uphill terrain.

**double pole with a kick**—A pushoff with one leg combined with a double pole.

**double poling**—A technique for forward propulsion using both poles simultaneously.

**downhill running**—A technique where skis are parallel, flat, and directed toward the fall line.

**downhill traverse**—A method to move diagonally across the fall line.

**dynamic parallel**—A technique similar to the basic parallel, but uses to a greater degree external forces generated by speed and ski-snow interaction.

**dynamic telemark**—A technique similar to the basic telemark, but uses to a greater degree external forces generated by speed and ski-snow interaction.

**edge control**—The action of adjusting the edge angle and edge pressure of the ski to the task at hand.

**fall line**—The most direct route downhill.

**forward sidestep**—A combination of the diagonal stride and the sidestep.

**free skiing**—Negotiation of varied and difficult terrain in accordance with snow condition and steepness of the slope.

**half herringbone**—A technique to ascend moderate slopes where two edged skis are not required.

**herringbone**—A method to climb straight uphill.

**inclination**—A vertical reference of the slope and projected body angles. Usually related to the results of angling movements.

**initiation phase of a turn**—The phase of a turn during which edges are changed to allow the skis to be turned. Internal (muscular) forces dominate this activity.

**kick turn**—A stationary turn to go in the opposite direction.

**leverage**—Applying pressure fore and aft of the center balance point of the skis.

**obstacle crossing**—A method of crossing ditches, fences, fallen trees, streams, and crevasses while on skis.

**parallel turn**—The action of preparing and initiating turns while the skis are pointed in the same direction. In pure form, remaining “parallel” through all phases of the turn.

**platform**—Provides the basis for stepping, stopping, or rebounding by setting of the skis' edges.

**pole plant**—In reference to turning, the momentary contact between the tip of the ski pole and the slope. This contact is generally used for weightlessness, blocking, timing, and deflecting during turning.

**recovery from a fall**—A method of regaining an upright position.

**sidestep**—A technique that helps a skier move uphill or downhill along the fall line.

**skate turn**—A dynamic step turn accomplished by pushing off an edged, divergent ski.

**skijoring**—Towing skimounted troops behind over-the-snow vehicles.

**skills**—In skiing, movements identified by turning, edging, and pressure control into which all movements can be categorized. It can be said that a number of skills make up a single technique.

**star turn**—A technique used to change direction when stationary on a flat surface.

**stem christie**—A technique similar to the wedge christie, but uses a stem movement to create the initial wedge position.

**stem telemark**—A technique similar to the wedge telemark, but uses a stem move to create the initial wedge position.

**step turn (in motion)**—A technique to change direction by stepping the skis divergently into a new direction.

**switchback**—A zigzag track in mountainous terrain.

**telemark glide**—A running or gliding position with the skis parallel, approximately shoulders' width apart. As the skier moves, one ski advances about one-quarter to one-half a ski's length.

**telemark position**—A neutral stance with one foot ahead of the other.

**telemark turn**—A turn during which skis remain staggered fore and aft throughout the turn.

**terrain absorption**—A technique to maintain balance by flexion and extension of the legs.

**terrain selection**—The act of choosing the appropriate terrain/snow condition for a given skill being taught or practiced. Proper selection is critical for highest success rate with students.

**traverse**—A method of moving across the hill at 90° to the fall line.

**turning**—The act of reorienting the skis and the body's direction of travel. Turning implies a change of the skier's path. Also used for control of speed while descending.

**uphill diagonal stride**—A Nordic technique for rhythmically ascending gradual to moderate slopes.

**uphill traverse**—A method to move diagonally across the fall line, gaining elevation.

**wedge christie**—A technique similar to the wedge turn, but the skis are matched to parallel as the turn progresses.

**wedge (gliding and braking)**—A technique for downhill running with skis in an “A” (convergent) position.

**wedge telemark**—A technique that initiates similar to the wedge christie, with the finish of the turn completed by moving into a telemark position.

**wedge turn**—A technique to change direction while maintaining an “A” or wedge position.

This Page Intentionally Left Blank

# REFERENCES AND RELATED PUBLICATIONS

## Army Field Manuals (FMs)

- 3-97.6 Mountain Operations
- 3-97.61 Military Mountaineering
- 9-207 Operations and Maintenance of Ordnance Materiel in Cold Weather
- 31-70 Basic Cold Weather Manual
- 31-71 Northern Operations

## Marine Corps Publications

### Marine Corps Warfighting Publications (MCWPs)

- 3-35.1 Mountain Operations (under development as *Mountain Warfare Operations*, number remains the same)
- 5-1 Marine Corps Planning Process

### Marine Corps Reference Publications (MCRPs)

- 3-35.1A Small Unit Leader's Guide to Cold Weather Operations (under development as *Small Unit Leader's Guide to Mountain Warfare Operations*, number remains the same)
- 3-35.1D Cold Region Operations

### Fleet Marine Force Manual (FMFM)

- 7-29 Mountain Operations (under development as MCWP 3-35.1, *Mountain Warfare Operations*)

### Fleet Marine Force Reference Publications (FMFRPs)

- 12-6 Commentary on Infantry Operations and Weapons Usage in Korea
- 12-48 On Winter Warfare
- 12-78 The White Death: The Epic of the Soviet-Finnish War

## Miscellaneous

A Guide to Cold Weather Operations. Booklet 8. Fieldworks and Camouflage. Headquarters Defence Command Norway. The Army Staff.

Manual of Military Mountaineering. Royal Marines Mountain Leaders. Mountain Leader Training Cadre.



This Page Intentionally Left Blank