



DEPARTMENT OF THE NAVY
HEADQUARTERS UNITED STATES MARINE CORPS
3000 MARINE CORPS PENTAGON
WASHINGTON DC 20350-3000

MCO 4000.56A
LPC-1
05 JAN 2017

MARINE CORPS ORDER 4000.56A

From: Commandant of the Marine Corps
To: Distribution List

Subj: MARINE CORPS POLICY ON DEPOT MAINTENANCE CORE
CAPABILITIES

Ref: (a) 10 U.S.C. Chapter 146, Section 2464
(b) DoD Instruction 4151.20, "Depot Maintenance Core Capabilities Determination Process," January 5, 2007
(c) DoD Directive 4151.18, "Maintenance of Military Materiel," March 31, 2004
(d) MCO 4790.21
(e) MCO 5311.1D
(f) MCO 3900.15B
(g) DoD Instruction 5000.02, "Operation of the Defense Acquisition System," January 7, 2015
(h) MAGTF Staff Training Program (MSTP) Pamphlet 5-0.3, MAGTF Planner's Reference Manual
(i) MCO 4400.39
(j) 10 U.S.C. Chapter 146, Section 2460
(k) 10 U.S.C. Chapter 146, Section 2462
(l) 10 U.S.C. Chapter 146, Section 2466
(m) DoD 4151.18-H, "Depot Maintenance Capacity and Utilization Measurement Handbook," March 10, 2007
(n) Defense Acquisition Guidebook, Chapter 5
(o) CJCSI 3170.01I
(p) SECNAVINST 5000.2E
(q) MCO 4790.19
(r) SECNAV M-5210.1
(s) National Defense Authorization Act FY16
(t) MCO 4790.24
(u) 5 U.S.C. 552a
(v) SECNAVINST 5211.5E

DISTRIBUTION STATEMENT A: Approved for public release;
distribution is unlimited.

- Encl: (1) Depot Maintenance Core Determination Process
(2) Depot Maintenance Core Capabilities Determination Process
(3) Depot Maintenance Core Capabilities Determination Process Charts
(4) New Acquisition Core Determination Process
(5) New Acquisition Core Determination Process Charts
(6) Contingency Requirements Factor Methodology
(7) Resource Adjustment Factor Methodology
(8) Terms and Definitions
(9) Acronyms

Report Required: Depot Maintenance Core Capabilities Determination Report (Report Control Symbol DD-4000-10) (External Report Control Symbol DD-AT&L(BI)2243)), par. 4b(1)(b) 8

1. Situation

a. Reference (a) requires all Services to maintain Government-owned and Government-operated (GO/GO) Core Logistics Capabilities to ensure "a ready and controlled source of technical competence and resources necessary to ensure effective and timely response to a mobilization, national defense contingency situations, and other emergency requirements." These Depot Maintenance (DM) Core Logistics Capabilities must be in place for each Core Principal End Item (CPEI) no later than four years after achieving Initial Operational Capability (IOC).

b. Reference (b) assigns responsibilities, outlines the methodology for the DM Core Capabilities (DMC2) Determination Process, and directs the Services to calculate and report DMC2 Determination to the Office of the Secretary of Defense (OSD) biennially.

c. Reference (c) directs that DM Core Logistics Capability requirements be identified "as early as possible in the acquisition life cycle" and "shall be established not later than four years after IOC."

d. Reference (d) applies regardless if the Source of Repair (SOR) is organic, Depot Maintenance Interservice Support Agreement (DMISA), or commercial. The recommendations and decisions cited must ensure Marine Corps-wide compliance with U.S. statutes, Department of Defense (DoD) requirements, and current orders while also best serving the needs of the Marine forces.

e. Reference (e) provides policy on the Total Force Structure Process and identifies Deputy Commandant for Combat Development and Integration (DC CD&I) as the Core Program Designation decision-maker pertaining to both new acquisitions and existing equipment. As such, DC CD&I is responsible to provide a list of all PEIs that are considered Core and the Core Quantity to Deputy Commandant for Installations and Logistics (I&L) 120 days prior to start of the Enterprise Lifecycle Maintenance Program (ELMP) Requirements Determination conference. I&L will forward to DC, Plans, Policies and Operations (DC PP&O) for validation and acceptance and will receive it from PP&O 105 days prior to the conference. Upon validation and acceptance, DC I&L will forward the list to Marine Corps Logistics Command (LOGCOM) 100 days prior to the conference.

f. Reference (f) establishes Marine Corps policy for conducting Capabilities Based Planning consistent with the Joint Capabilities Integration and Development System (JCIDS). The Expeditionary Force Development System (EFDS) is used to develop future war-fighting capabilities to meet national security objectives.

g. Reference (g) establishes a simplified and flexible management framework for translating capability needs and technology opportunities into stable, affordable, and well-managed acquisition programs. Enclosure (1), Table 2 of the reference states that "only the CORE LOGISTICS DETERMINATION is required at Milestone A. Required at Milestone C if there was no Milestone B. Documented in the Life-Cycle Sustainment Plan (LCSP). Not required for AIS programs."

h. Reference (h) contains general planning considerations and scenario-independent planning factors that may be helpful for estimating contingency scenario Operational Tempo (OPTEMPO) for the Contingency Requirements Factor (CRF).

i. Reference (i) contains information on Combat Active Replacement Factors (CARFs). CARF rates are logistics planning factors used to estimate equipment losses in future conflicts and can be used to estimate the combat damage rate within the CRF calculation.

j. Reference (j) provides the definition of depot-level maintenance and repair. It provides examples of depot-level maintenance and repair and identifies exceptions to the definition.

k. Reference (k) provides an understanding of the public-private competition. It also provides details about the reports the Secretary of Defense must submit in order to commence the public-private competition.

l. Reference (l) details the percentage limitation of funds that can be dedicated to contracts and explains the annual report required by the Secretary of Defense that estimates the percentage of funds required for contracts.

m. Reference (m) provides a methodology to calculate DM capacity and utilization. Part of the maintenance capacity and utilization calculation is the Core Capacity Index, which is based on the DMC2 Determination Process results.

n. Reference (n) provides the associated guidance the Program Manager (PM) and Life-Cycle Logistician can use in influencing the design and providing effective, timely product support capability to achieve a PEI's materiel readiness and sustain operational capability.

o. Reference (o) establishes the policies for JCIDS. The procedures established in JCIDS support the Chairman of the Joint Chiefs of Staff (CJCS) and the Joint Requirements Oversight Council (JROC) in identifying and assessing joint military capability needs. There are three key processes in the DoD that must work in concert to deliver the capabilities required by the warfighter: the Requirements Process; the Defense Acquisition System; and the Planning, Programming, Budgeting, and Execution (PPBE) Process. This instruction focuses on the Requirements Process as implemented in JCIDS.

p. Reference (p) issues mandatory procedures for the Department of the Navy's (DON) implementation of DoD Directives and Instructions regarding the Defense Acquisition System for major and non-major defense acquisition programs and the CJCS Instruction and Manual regarding JCIDS.

q. Reference (q) establishes the policy of the Commandant of the Marine Corps (CMC) to provide DM support to the operating forces and to maintain an optimum state of contract, organic, interservice DM readiness in support of the Marine Corps force structure and mobilization plans. It lists and describes applicable directives and assigns responsibilities to subordinate elements.

r. Reference (r) establishes policies and procedures for

life-cycle management (creation, maintenance, use, and disposition) of DON records.

s. Reference (s) modified Title 10, 2464 and requires the DoD to submit a Biennial Core Report to Congress on each even-numbered year beginning 2012 no later than 60 days after the budget of the President is submitted.

t. Reference (t) establishes policies and procedures for all Marine Corps Stakeholders to annually review depot maintenance requirements and execution returns plans to balance depot maintenance requirements to available resources. Core Determination is an important input to the ELMP process.

2. Cancellation. MCO 4000.56 W/ERRATUM.

3. Mission. To provide policy and procedural guidance concerning the requirement for maintenance of Marine Corps DM Core Logistics Capabilities and execution of the DM Core Determination Process. This process supports the Marine Corps Equipment Optimization Process by identifying equipment sets necessary to meet our Title X responsibilities and maintain organic depot capabilities. It includes the New Acquisition Core Determination (NACD) Process and the DMC2 Determination Process.

4. Execution

a. Commander's Intent and Concept of Operations

(1) Commander's Intent. The DM Core Determination Process facilitates the identification, retention, and reporting of DM Core Logistics Capabilities in compliance with reference (a) and reference (b) and aids in force reset by ensuring DM Core Logistics Capabilities are present and mission capable within the DoD organic Depots.

(2) Concept of Operations

(a) This Order provides policy for a standard, repeatable process for identifying, retaining, and reporting of Marine Corps DM Core Logistics Capabilities. All new material acquisitions and currently-fielded PEIs will be subject to the processes outlined in this Order. Specific policy and procedural guidance is contained in enclosures (2) through (9).

(b) The DM Core Determination Process is an overarching process encompassing the DMC2 Determination Process and the NACD Process.

1. The DMC2 Determination Process is a requirement, initiated by the Office of the Under Secretary of Defense for Acquisition, Technology, and Logistics (USD AT&L), to identify required DM Core Logistics Capabilities and report them via the DMC2 Determination Report submitted each even numbered year to USD AT&L. This Order implements the USD AT&L requirements into Marine Corps organizations and processes.

2. The NACD Process is how a PEI is analyzed during the EFDS and/or Defense Acquisition System phases of development to determine its status as a DM Core requirement and to ensure a GO/GO DM Core Logistics Capability is in place as early as possible in the acquisition lifecycle, but no later than four years after IOC. This process directs the actions pertaining to a Core determination and Core Quantity determination. Core Quantity decision denotes the quantity of assets designated for use in war time scenarios.

b. Subordinate Element Missions

(1) DC I&L

(a) Update DM Core Determination policy as necessary.

(b) In Support of the DMC2 Determination Process:

1. Oversee DMC2 Core Determination Process which starts with an annual data call tasking DC, CD&I to begin determination of Core and Core Quantities 150 days prior to the start of the ELMP Requirements Determination conference.

2. Provide Core and Core Quantity determination to PP&O for validation and acceptance.

3. Coordinate with Marine Corps Systems Command (MCSC), and Program Executive Officer Land Systems (PEO LS) to identify the PEI to be included in the Depot Level Repairable Equipment List (a.k.a. Tasked Platform System). Calculation of Core quantity is an iterative and deliberate process that will adjust quantities based on density, warfighting values and depot maintenance quantities. List will be provided to LOGCOM 100

days prior to start of ELMP Requirements Determination conference.

4. Lead and coordinate with MCSC, PEO LS, the Advocates, and LOGCOM to identify PEIs to be excluded from the Depot Level Repairable Equipment List and provide them to LOGCOM 100 days prior to start of the ELMP Requirements Determination Conference.

5. Develop the CRF and provide it to LOGCOM 100 days prior to start of the ELMP conference.

6. Lead and coordinate with LOGCOM in developing the DMC2 Determination Report.

7. Review and approve DMC2 Determination Report and submit information to ELMP Requirements Determination conference coordinator 30 days prior to start of Conference.

8. Review and submit DMC2 Determination Report to USD AT&L no later than (NLT) 1 Apr of each even-numbered year in accordance with reference (a). Report Control Symbol DD-4000-10 (External Report Control Symbol DD-AT&L(BI)2243) is assigned to this reporting requirement. SECDEF must submit to Congress a report of the following:

a. Core depot-level maintenance requirements and associated sustaining workloads sorted by work breakdown structure (WBS) and expressed in Direct Labor Hours (DLH).

b. Workloads necessary to sustain Core depot-level maintenance expressed in DLH and cost.

c. In any case where Core requirements are expected to exceed sustaining workloads, a rationale for the shortfall along with a plan for mitigating or correcting the shortfall.

d. Cost of Production - Man-hours required to produce the Biennial Core Report (DMC2) by all the stakeholders.

(c) In Support of the NACD Process:

1. Coordinate with MCSC/PEO LS to disseminate the Core determination to stakeholders through appropriate documentation and/or systems of record.

2. Coordinate with CD&I to disseminate the Core Quantity determinations to stakeholders through appropriate documentation and/or systems of record.

3. Coordinate with CD&I, MCSC, PEO LS, and LOGCOM to ensure Depot Source of Repair (DSOR) decisions are made in accordance with Core determination and Core Quantity determination per reference (d).

4. EGEM will use the Core Quantities in EOP decisions.

(2) DC CD&I

(a) In Support of the DMC2 Determination Process:

1. Request DC CD&I provide an approved list of all ME that is to be considered Core (by TAMCN and quantity) to DC I&L annually 120 days prior to start of the ELMP Requirements Determination conference. Core, relative to the Depot Maintenance Core Capability Determination Process, is hereby defined as any equipment or weapon system under development to replace an item on the T/E, or being developed as an addition to the T/E, to be utilized in the most stringent Joint Chiefs of Staff (JCS) warfighting scenarios. Coordinate with Advocates, DC PP&O, LOGCOM, MCSC and stakeholders as required to review and validate the Core List.

2. Request DC CD&I provide the Core Quantity List to MCSC for inclusion as the basis of the Depot Level Repairable (DLR) Equipment list and DM Core Quantity determination.

(b) In Support of the NACD Process:

1. Oversee NACD Process.

2. Coordinate with MCSC and PEO LS to determine if a new acquisition PEI will require depot repair. This determination should be made as early as possible in the acquisition process. All new acquisitions that have matured enough to make a DM Core determination and quantity estimate

will be included in the annual response to DC I&L's data call, separate from the DMC2 120 days prior to start of the ELMP Requirements Determination conference.

3. Coordinate with MCSC or PEO LS to evaluate the materiel initiative for exception to the DM Core Logistics Capability requirement as defined in reference (a).

4. Coordinate with I&L, MCSC, PEO LS, and LOGCOM to ensure DSOR decisions are made in accordance with DM Core determinations and Core Quantity determinations, per reference (d).

(3) Commanding General (CG), LOGCOM

(a) In Support of the DMC2 Determination Process:

1. Identify total inventory of PEIs on the Depot Level Repairable Equipment List. LOGCOM will enter the total inventory in Column A2 of the DMC2 Determination Report.

2. Coordinate with I&L, MCSC, PEO LS, and the Advocates to identify PEIs to be excluded from the Depot Level Repairable Equipment List in accordance with reference (a). LOGCOM will enter the information into Column B of the DMC2 Determination Report.

3. Lead and coordinate with I&L to prepare Columns C through Q of the DMC2 Determination Report. LOGCOM will submit the DMC2 Determination Report to I&L 40 days prior to start of the ELMP Requirements Determination Conference for their review and approval.

4. Lead the preparation of the DMC2 Determination Report narrative, including an introduction addressing the Marine Corps' planned application of workload to sustain computed DM Core Logistics Capability requirements, and identification of workload shortfalls (if any). LOGCOM will submit the narrative along with the Part 1 and Part 2 worksheets to HQMC Logistics Policy and Capabilities Branch (LPC) to meet OSD's due date.

5. Develop the Resource Adjustment Factor (RAF) for the DMC2 Determination Report while preparing the Core Report.

05 JAN 2017

(b) In Support of the NACD Process: Coordinate with I&L, CD&I, MCSC, and PEO LS to ensure DSOR decisions are made in accordance with Core and Core Quantity determinations per reference (d).

(4) Commander, MCSC/PEO LS

(a) In Support of the DMC2 Determination Process:

1. Coordinate with I&L, the Advocates, and LOGCOM to identify PEIs to be excluded from the Depot Level Repairable Equipment List.

2. MCSC/PEO LS will provide I&L with the Evacuation Criteria with corresponding usage related metrics or (specific condition description in the case of Inspect and Repair Only as necessary in the LCSP and in the ELMP data call for each platform/weapon system to be used to calculate the average quantity that comes into the Marine Depot Maintenance Command (MDMC) each year for Column C of the DMC2 Determination Report. I&L will provide the information to LOGCOM 100 days prior to start of the ELMP Requirements Determination conference.

(b) In Support of the NACD Process:

1. Lead and coordinate with CD&I to evaluate the materiel initiative for exception to the DM Core Logistics Capability requirement as defined in reference (a). If an exception applies, submit the recommendation for exception to the Milestone Decision Authority (MDA) and LOGCOM for review. This exception is separate from any other depot requirement, such as Depot Source of Repair (DSOR).

2. Lead and coordinate with I&L, CD&I, and LOGCOM to ensure DSOR decisions are made in accordance with Core and Core Quantity determinations. References (d) and (s) apply.

(5) DC PP&O.

(a) Request review the CD&I generated Tables of Equipment (TEs) used in the Joint Chiefs of Staff (JCS) war fighting scenarios (by Table of Authorized Material Control Number (TAMCN) and quantity) [Core Quantity List] 105 days prior to the ELMP conference for adjudication and concurrence.

(b) Reviews and approves the Warfighting Values needed for ELMP Depot Level work requirements.

(c) Review the LOGCOM generated Depot Core Report (aka DMC2 Determination Report).

(6) Commanders, MARFORs. In Support of the DMC2 Determination Process: Request coordination with CD&I to identify a force list that supports current contingency scenarios in accordance with CD&I's timeline.

(7) Advocates. In Support of the DMC2 Determination Process:

(a) Coordinate with CD&I to identify a force list that supports current contingency scenarios.

(b) Coordinate with I&L, MCSC, PEO LS, and LOGCOM to identify PEIs that are to be excluded from the Depot Level Repairable Equipment List.

5. Administration and Logistics

a. DMC2 Determination Process. The DMC2 Determination Process will be initiated by Headquarters, Marine Corps, DC I&L 150 days prior to the ELMP requirements determination conference.

b. DMC2 Determination Report Format. The DMC2 Determination Report will be provided in the format specified by reference (b).

c. NACD Process. The NACD Process will be initiated by CD&I.

d. Records Management. Records created as a result of this Order shall be managed according to National Archives and Records Administration approved dispositions per reference (r) to ensure proper maintenance, use, accessibility and preservation, regardless of format or medium.

e. Recommendations concerning the contents of this Order may be forwarded to HQMC I&L, LPC via the appropriate chain-of-command.

f. Privacy Act Statement. The generation, collection, or distribution of Personally Identifiable Information (PII), and

05 JAN 2017

management of privacy sensitive information shall be in accordance with the Privacy Act of 1974, as amended, per references (u) and (v). Any unauthorized review, use, disclosure or distribution is prohibited.

6. Command and Signal

a. Command. This Order is applicable to Marine Corps Total Force.

b. Signal. This Order is effective the date signed.



M. G. DANA
Deputy Commandant for
Installations and Logistics

DISTRIBUTION: PCN 10203932700

Depot Maintenance Core Determination Process

Overview

1. DoD is required to retain a DM Core Logistics Capability. Paragraph (a)(3) of reference (a) defines Core Logistics Capability as: "those capabilities that are necessary to maintain and repair the weapon systems and other military equipment (including mission essential weapon systems or materiel not later than four years after achieving initial operational capability, but excluding systems and equipment under special access programs (SAP), nuclear aircraft carriers, and commercial items...) that are...necessary to enable the armed forces to fulfill the strategic and contingency plans prepared by the Chairman of the Joint Chiefs of Staff..."

2. The DM Core Determination Process is an over-arching process encompassing the DMC2 Determination Process and the NACD Process. However, the DMC2 Determination Process and NACD Process are not completely independent.
 - a. Establishing Core requirements for a specific PEI as it processes through the EFDS and Defense Acquisition System results in a DM Core Logistics Capability that must be captured in the DMC2 Determination Report once the PEI reaches IOC plus four years.

 - b. The DMC2 Determination Report currently covers a two-year window and must include all PEIs that will impact the Core requirements during that two-year window. Therefore, any PEI that is at, or will reach, IOC plus four years within the two-year DMC2 Determination Report window must be included. This includes any PEI that is at IOC plus two years at the time of the DMC2 Determination Report.

Depot Maintenance Core Capabilities Determination Process

Overview

1. The DMC2 Determination Process (process chart shown in enclosure (3)) is a process that identifies the DM capabilities needed to ensure that the Marine Corps has a ready and controlled source of DM Core Logistics Capabilities to maintain the forces that support the contingency scenarios. The DMC2 Determination Process is directed by reference (b) and the instructions in this Order use the direction and formats from reference (b) as they apply to the Marine Corps.
2. The DMC2 Determination Process is initiated 150 days prior to the ELMP Requirements Determination Conference.
3. Per reference (s), USD AT&L formally initiated this process biennially every even-numbered year beginning 2012. This report will be provided by DoD to Congress 60 days after the date on which the budget of the President is submitted to Congress. The results of the DMC2 Determination calculation will be used during life cycle management planning and annual budget preparation.
4. The output of the DMC2 Determination Process is the DMC2 Determination Report. The DMC2 Determination Report is submitted to USD AT&L (via HQMC), where it is combined with the other Service report submissions and is reported to Congress as an aggregate overall DoD Core requirement. The DMC2 Determination Report consists of a report narrative and a worksheet.
 - a. Narrative. The DMC2 Determination Report includes a narrative introduction that addresses the planned application of workload to sustain computed DM Core Logistics Capability requirements, and identification of workload shortfalls (if any).
 - b. Worksheet. The DMC2 Determination Report also includes a worksheet that contains the DM Core Logistics Capability requirements and workload against the requirements. The worksheet is divided into two parts: Part 1 and Part 2.

05 JAN 2017

(1) Part 1. Part 1 (Columns A through H) identifies DM Core Logistics Capability requirements in terms of DLH with adjustments for inter-Service considerations.

(2) Part 2. Part 2 (Columns I through Q) identifies DM workloads in DLHs and cost to support DM Core Logistics Capability requirements.

(3) The format of Part 1 and Part 2 of the DMC2 Determination Report worksheet is found in Figures 2-1 and 2-2. Throughout Part 1, at a minimum, WBS categories, dictated by reference (b), are to be completed to the third level of indenture for aircraft and aircraft components, the second level of indenture for aircraft engines, and the first level of indenture for all other categories. Not all WBS categories may be applicable in all reporting years.

Description	Column A			Column B	Column C		Column D		Column E	Column F	Column G		Column H
	Determine Systems in JCS Contingency Scenarios			Identify Exclusions	Convert Requirements to Peacetime DLHs	Scenario Requirements to Peacetime DLHs	Adjust for Contingency Rqmts and Resources		Adjust for Redundant Requirements	Quantify Core Depot Maint Capability Rqmts	Adjust for Interservice Requirements		Total Adjusted Requirements
WBS Category	Tasked Platform System	Total Active Inventory	Number in Scenarios	Net After Exclusions	Platform DLHs	DLR DLHs	Result After Contingency Adjustment	Result After Resource Adjustment	Redundant Rqmts	DLHs	Interservice In	Interservice Out	Adjusted Requirements
1. Aircraft													
1.1. Airframes													
1.1.1. Rotary													
1.1.2. VSTOL													
1.1.3. Cargo/Tanker													
1.1.4. Fighter/Attack													
1.1.5. Bomber													
1.1.6. Aircraft - Other													
1.2. Aircraft Components													
1.2.1. Dynamic Components													
1.2.2. Hydraulic/Pneumatic													
1.2.3. Instruments													
1.2.4. Landing Gear													
1.2.5. Aviation Ordnance													
1.2.6. Avionics/Electronics													
1.2.7. APUs													
1.2.8. Other													
1.3. Aircraft Engines													
2. Ground Vehicles													
2.1. Combat Vehicles													
2.2. Amphibious Vehicles													
2.3. Tactical (wheeled) Vehicles													
2.4. Construction Equipment													
3. Sea Ships													
3.1. Aircraft Carriers													
3.2. Submarines													
3.3. Surface Combatants/Others													
4. Communication/Electronic Equipment													
4.1. Radar													
4.2. Radio													
4.3. Wire													
4.4. Electronic Warfare													
4.5. Navigational Aids													
4.6. Electro-Optics/Night Vision													
4.7. Crypto													
4.8. Computers													
4.9. Other													
5. Support Equipment													
5.1. GSE													
5.2. Generators													
5.3. TMDE													
5.4. Calibration													
5.5. Other													
6. Ordnance, Weapons, & Missiles													
6.1. Nuclear Weapons													
6.2. Chemical Weapons													
6.3. Biological Weapons													
6.4. Conventional Weapons													
6.5. Explosives													
6.6. Small Arms/Personal Weapons													
6.7. Strategic Missiles													
6.8. Tactical Missiles													
6.9. Other													
7. Software													
7.1. Weapon System													
7.2. Support Equipment													
8. Fabrication/Manufacturing													
9. Fleet/Field Support													
10. Special Interest Items													
11. Other													

Figure 2-1.--DMC2 Determination Report Worksheet - Part 1.

	Description	Column I Quantity Total Depot Maintenance Workload	Column J Add/Subtract Interservice Workload Adjustments		Column K Identify and Compute Workload Needed to Maintain DM Core Capability Rqmts	Column L Determine Total DM Workload Not Needed to Support DM Core Capability Rqmts	Column N Private- Sector DM Workload	Column O Public- Sector DM Workload	Column Q Estimated Cost of Core Sustaining Workload
			J1 DLHs In	J2 DLHs Out					
1	Aircraft								
	1.1 Airframes								
	1.1.1 Rotary								
	1.1.2 VSTOL								
	1.1.3 Cargo/Tanker								
	1.1.4 Fighter/Attack								
	1.1.5 Bomber								
	1.1.6 Aircraft - Other								
	1.2 Aircraft Components								
	1.2.1 Dynamic Components								
	1.2.2 Hydraulic/Pneumatic								
	1.2.3 Instruments								
	1.2.4 Landing Gear								
	1.2.5 Aviation Ordnance								
	1.2.6 Avionics/Electronics								
	1.2.7 APUs								
	1.2.8 Other								
	1.3 Aircraft Engines								
2	Ground Vehicles								
	2.1 Combat Vehicles								
	2.2 Amphibious Vehicles								
	2.3 Tactical (wheeled) Vehicles								
	2.4 Construction Equipment								
3	Sea Ships								
	3.1 Aircraft Carriers								
	3.2 Submarines								
	3.3 Surface Combatants/Others								
4	Communication/Electronic Equipment								
	4.1 Radar								
	4.2 Radio								
	4.3 Wire								
	4.4 Electronic Warfare								
	4.5 Navigational Aids								
	4.6 Electro-Optics/Night Vision								
	4.7 Crypto								
	4.8 Computers								
	4.9 Other								
5	Support Equipment								
	5.1 GSE								
	5.2 Generators								
	5.3 TMDE								
	5.4 Calibration								
	5.5 Other								
6	Ordnance, Weapons, & Missiles								
	6.1 Nuclear Weapons								
	6.2 Chemical Weapons								
	6.3 Biological Weapons								
	6.4 Conventional Weapons								
	6.5 Explosives								
	6.6 Small Arms/Personal Weapons								
	6.7 Strategic Missiles								
	6.8 Tactical Missiles								
	6.9 Other								
7	Software								
	7.1 Weapon System								
	7.2 Support Equipment								
8	Fabrication/Manufacturing								
9	Fleet/Field Support								
10	Special Interest Items								
11	Other								
	Total								

Figure 2-2.--DMC2 Determination Report Worksheet - Part 2.

2. Methodology

a. DMC2 Determination Report Narrative. The DMC2 Determination Report includes a narrative that addresses the planned application of workload to sustain DM Core Logistics Capability requirements and identification of workload shortfalls (if any). If there are capability shortfalls, the narrative must include plans to rectify capability shortfalls, including a description of planned capital investment, timing, and planned workarounds until the new capability is available.

b. DMC2 Determination Report Worksheet Part 1. Part 1 identifies the DM Core Logistics Capability requirements in terms of DLH with adjustments for inter-Service considerations. DM Core Logistics Capability requirements are satisfied using a single-shift, 40-hour workweek, in order to preserve the ability to respond effectively to surge requirements through expanded work hours or additional shifts during emergency operations. The starting point is the OSD-promulgated planning guidance to define force structure necessary to execute contingency scenarios. Once the force structure is identified, the forces are associated with platforms/PEIs and any system that is excluded from the DMC2 Determination Process is documented, citing the authority for the exclusion. The DLHs are adjusted for "surge" factors during the different phases of a contingency. The most appropriate composite "surge" adjustment is determined and the DM Core Logistics Capability requirements are assessed to determine redundancy. Once any redundancy is eliminated, the remaining DLHs are designated as the DMC2 requirements.

(1) Column A - Determine Systems in JCS Scenarios. Consider all platforms/weapon systems tasked in the contingency scenarios.

(a) Column A1 - Tasked Platform System. CD&I will determine the TE (platforms/weapons systems (TAMCN) and associated requirement/quantity) that are needed in support of the contingency scenarios (Core quantity list). MCSC and PEO LS will determine what PEI's are depot repairable (Depot Level Repairable Equipment List). Upon receipt of the information from I&L, LOGCOM will enter the systems in Column A1.

(b) Column A2 - Total Active Inventory. LOGCOM will quantify the total active inventory (i.e., the total quantity across the entire Marine Corps) for each platform/weapon system identified in Column A1 and will enter the total active inventory in Column A2.

(c) Column A3 - Number in Scenarios. CD&I will identify the quantities required to support the contingency scenarios (i.e., the Core Quantity) for each platform/weapon system identified in Column A1 for input into DMC2 Report. For some platforms/weapon systems, the entire active inventory may be the DM Core Quantity, but generally a portion of the fielded items will not be included in the DM Core Quantity, such as those used at bases and stations or used at formal training commands. CD&I will provide the information to I&L for review and approval. I&L will then forward the information to LOGCOM. LOGCOM will enter the DM Core Quantity in Column A3. It is worth noting Column A3 is a subset of Column A2 and serves as a good cross-check when developing the Core requirements data.

(2) Column B - Identify Net After Exclusions. I&L, in coordination with MCSC, PEO LS, the Advocates, and LOGCOM, will identify any platforms that are excluded from the requirement to maintain DM Core Logistics Capabilities and document the authority for the exclusion. Based on paragraphs (a)(3) and (a)(5) of reference (a), systems and equipment can be excluded if they are special access programs, nuclear aircraft carriers, or commercial items that have been sold or leased in substantial quantities to the general public and are purchased without modification in the same form that they are sold in the commercial marketplace, or with minor modifications to meet Federal Government requirements. I&L will provide the information to LOGCOM and LOGCOM will record in Column B the net quantity of each platform/weapon system when the quantity that is excluded is subtracted from the quantity in the contingency scenarios. [Column B = Column A3 - Quantity Excluded] I&L will document the authority for each exclusion and provide this documentation to LOGCOM to incorporate in the DMC2 Report narrative. With the exception of Column A2, I&L will provide LOGCOM with the information in Columns A and B for LOGCOM to complete Columns C through Q.

(3) Column C - Convert Scenario Requirements to Peacetime DLHs

(a) Column C1 - Platform DLHs. LOGCOM will use appropriate factors (e.g., historical workload averages, work standards, occurrence factors, historical peacetime capabilities, technology-based requirements) to convert platform/weapon system requirements in Column B into annual peacetime DM DLHs. LOGCOM will record the platform/weapon system DLHs in Column C1. Peacetime DLHs are calculated by determining the average quantity of each platform/weapon system that comes into the MDMC each year multiplied by the average time to repair the platform/weapon system (based on historical data). The average quantity of each platform/weapon system that comes into the MDMC each year can be calculated by taking the quantity in Column A3 and dividing it by the Evacuation Criteria of the platform/weapon system. MCSC/PEO LS will provide I&L with the Evacuation Criteria (in years) for each platform/weapon system. I&L will provide this information to LOGCOM. If there is no previous history of the platform/weapon system being maintained at the depot, a similar system may be used as a surrogate. If the platform/weapon system is not similar to existing equipment, the following methodology can be used to estimate DLHs:

1. Determine the standard unit price for the platform/weapon system. Estimate the cost of repair as a function of the standard unit price. For example, a rule of thumb may be that an item would not be repaired if the repair cost is more than 65 percent of the standard unit cost. If this were the case then the maximum cost of repair would be 65 percent of the standard unit cost. [Cost of Repair = Unit Price * Maximum Percentage of Unit Price Where Item Would be Repaired].

2. Estimate the amount of the repair cost that would be allocated for labor. [Labor Cost = Cost of Repair * Percentage of Costs that are Labor].

3. Determine the average charge for one hour of industry manufacturing labor. Divide the labor cost by the average cost for an industry manufacturing labor hour to get the number of labor hours needed to repair the platform/weapon system. [DLH per System = Labor Cost / Cost per Hour for Labor].

4. Estimate the percentage of Core platforms/weapon systems that will come into the depot for maintenance each year. To get the total DLH, multiply this percentage by the quantity of Core items (Column A3) and then multiply by the DLH per System. [Total DLH = DLH per System * (A3 * Percent of Core Systems per Year)].

(b) Column C2 - DLR DLHs. LOGCOM will identify DLRs that are installed in the platforms or otherwise employed in the contingency scenarios but not already included in Column A. LOGCOM will determine peacetime DLHs for these DLRs and record the DLR DLHs in Column C2.

(4) Column D - Adjust for Contingency Requirements and Resources

(a) Column D1 - Result After Contingency Adjustment. I&L will develop the CRF per enclosure (6) and provide it to LOGCOM. LOGCOM will adjust the annual peacetime DM DLH by applying the CRF provided by I&L. LOGCOM will multiply the DLHs in Column C1 and Column C2 by the CRF and record the result (in DLHs) in Column D1. [Column D1 = (Column C1 + Column C2) * CRF]

(b) Column D2 - Result After Resource Adjustment. LOGCOM will develop a RAF that accounts for the ability of on-hand peacetime DM resources to increase production by operating additional hours without being augmented by additional facilities, equipment, or personnel. The RAF should be developed per enclosure (7). LOGCOM will divide the DLHs in D1 by the RAF and record the results (in DLHs) in Column D2. [Column D2 = Column D1 / RAF]

(5) Column E - Adjust for Redundant Requirements. LOGCOM will identify redundant requirements and record them in (in DLHs) Column E. Redundant requirements include maintenance and repair requirements that are similar to existing requirements already being performed. These redundant requirements can be identified (during the Core Logistics Analysis (CLA)/Core Depot Assessment process) by comparing the repairable components within the two similar end items or DLRs to determine what is the same and what is different about the depot repair processes for each component. Like or duplicate repair processes can be considered a redundant Core capability. Additionally, one way to determine if a new or modified weapon system can be considered a redundant requirement is if it meets the following criteria:

(a) The maintenance and repair requirement associated with a new or modified system/DLR is an exact (100 percent) duplicate of an existing requirement that is already being performed.

(b) The tools, test equipment, technical data, and facilities needed to perform the maintenance and repair associated with the new or modified system/DLR are currently on-hand and available.

(c) The organic depot employees have been trained and have previously executed the labor skills needed to perform the maintenance and repair associated with the new or modified system/DLR in the past.

(6) Column F - Quantify DMC2 Requirements. LOGCOM will subtract the redundant requirements in Column E from the results of Column D2 and record the result in Column F. [Column F = Column D2 - Column E].

(7) Column G - Adjust for Interservice Capability Requirements

(a) Column G1 - Interservice In. LOGCOM will determine other DoD Component DM Core Logistics Capability requirements that are maintained in MDMC. These are the DLHs that the Marine Corps performs in support of other Services' DM Core Logistics Capability requirements. Record the amount (in DLHs) in Column G1.

(b) Column G2 - Interservice Out. LOGCOM will determine Marine Corps DM Core Logistics Capability requirements (from Column F) that are maintained in other DoD Component depots. These are the DLHs that other Services perform for the Marine Corps' DM Core Logistics Capability requirement. Record the amount (in DLHs) in Column G2.

(8) Column H - Calculate the Total Adjusted Requirements. LOGCOM will use the Marine Corps DM Core Logistics Capability requirements (Column F) and add the requirements from other DoD Components that are maintained by the Marine Corps (Column G1) and subtract the Marine Corps requirements that are maintained elsewhere (Column G2). LOGCOM will record the result in Column H. [Column H = Column F + Column G1 - Column G2].

c. DMC2 Determination Report Worksheet Part 2. Part 2 identifies the workloads necessary to maintain the DM Core Logistics Capabilities requirements identified in Part 1. In this part, the DM workloads needed to maintain DM Core Logistics Capabilities are subtracted from total public sector DM funded workload, leaving those workloads that are not necessary to sustain DM Core Logistics Capabilities requirements, and are therefore available for Service SOR decisions. Part 2 establishes a minimum level of public sector DM workloads. This data may also be used to assist in the identification of DM capital investments that must be made to comply with reference (a) requirements for establishment of DM Core Logistics Capabilities within four years of IOC. Part 2 calculations are done at the WBS level vice the TAMCN level, as in Part 1.

(1) Column I - Quantify the Total DM Workload. LOGCOM will quantify all public sector DM workloads in DLHs and record the data in Column I. Column I includes only Marine Corps "organic" depot maintenance funded workload to include outgoing Marine Corps Interservice workload.

(2) Column J - Add/Subtract Interservice Workload Adjustments

(a) Column J1 - DLHs In. LOGCOM will determine Marine Corps workloads provided to fulfill other DoD Component DM Core Logistics Capabilities requirements and record the amount (in DLHs) in Column J1. J1 consists of all incoming workload (both Core and non-Core).

(b) Column J2 - DLHs Out. LOGCOM will determine other DoD component workloads that are provided to fulfill Marine Corps DM Core Logistics Capabilities requirements and record the amount (in DLHs) in Column J2. J2 includes all Marine Corps Interservice outgoing workload (both DM Core and non DM Core).

(3) Column K - Identify and Compute Workload Needed To Maintain DMC2 Requirements. Consider the information in Column H to identify workloads to sustain DM Core Logistics Capability requirements. LOGCOM will calculate the sum of the workload requirements in Column H for all of the TAMCNs in each WBS and record the Core sustaining workload requirements (in DLHs) in Column K. Column K calculation is a roll up of Column H by WBS.

(4) Column L - Determine DM Workload Not Needed to Support DM Core Logistics Capability Requirements. LOGCOM will identify the DM workloads that do not directly support DM Core Logistics Capability requirements and record the result in Column L. [Column L = Column I + Column J1 - Column J2 - Column K].

(5) Column M - Sector Selection. LOGCOM will record in Column M the sources of repair for all DM workloads in Column L. This step does not result in an entry on the DMC2 Worksheet (i.e., Column M is not included in the report to OSD).

(6) Column N - Private Sector DM Workload. LOGCOM will quantify, in terms of funding required (\$), the DM workload performed in the private sector and record this value in Column N.

(7) Column O - Quantify Public Sector DM Workload. LOGCOM will quantify (in DLHs) public sector workload that supports DM Core Logistics Capabilities plus any other workload appropriately performed by the public sector. LOGCOM will determine the amount of workload performed on equipment from sources other than the Services (such as foreign military sales or non DoD) and add it to the values in Column O. [Column O = Column K + Column L + PEIs from other sources]

(8) Column P - Output to Service Planning, Programming, and Budgeting System. LOGCOM will use workload data from Columns K and O to identify DM Core Logistics Capability requirements for the PPBE Process. I&L will ensure the DM Core Logistics Capability requirements are represented with the appropriate emphasis in the PPBE process. This step does not result in an entry on the DMC2 Worksheet (i.e., Column P is not included in the report to OSD).

05 JAN 2017











(9) Column Q - Estimated Cost of Sustaining Workload. An estimate of the cost to sustain workloads will be made in accordance with references (b) and (s). Column Q = Column F (Worksheet One; Core DM Capability Requirements in DLHs) * Future Composite Billing Rate.

d. Prepare and submit the DMC2 Determination Process Report. LOGCOM will prepare the DMC2 Determination Report Narrative. LOGCOM will submit the DMC2 Determination Report (to include the DMC2 Determination Report Narrative, and Part 1 and 2 of the DMC2 Determination Report Worksheet) to I&L. Compare column K to column O to identify shortfalls. If Column K is greater than Column O, a shortfall exists. I&L will review the DMC2 Determination Report and submit to ELMP Requirements Determination Conference. In addition, submit a biennial report to USD AT&L.

Depot Maintenance Core Capabilities Determination Process Charts

Overview. The DMC2 Determination Process charts show the flow of information, coordination and data that is necessary to complete the DMC2 Determination Report. The process charts include vertical columns that correspond to the steps directed in reference (b) for the DMC2 Determination Report. The horizontal rows show organizational roles and responsibilities. The symbols used in the process charts are shown in Table 3-1. The process charts are shown in Figures 3-2 through 3-3.

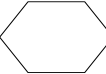
Table 3-1.--Symbols Used in Process Charts.

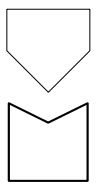
Symbol	Use	Symbol	Use
	Process Start Point: action that initiates the process		Termination: the point at which the process is complete or monitoring outside this process occurs
	Predefined Marine Corps Process that happens outside the process depicted		Direction of the process depicted
	Action: represents an action taken in the process		Information
	Process/Action outside the Marine Corps		Coordination
	Preparation: action taken to prepare a document or report		Tasking/Direction
	Data: data that is produced or provided		Connector Out/Connector In: results from one area in the process are transferred to different, non-sequential area in the process

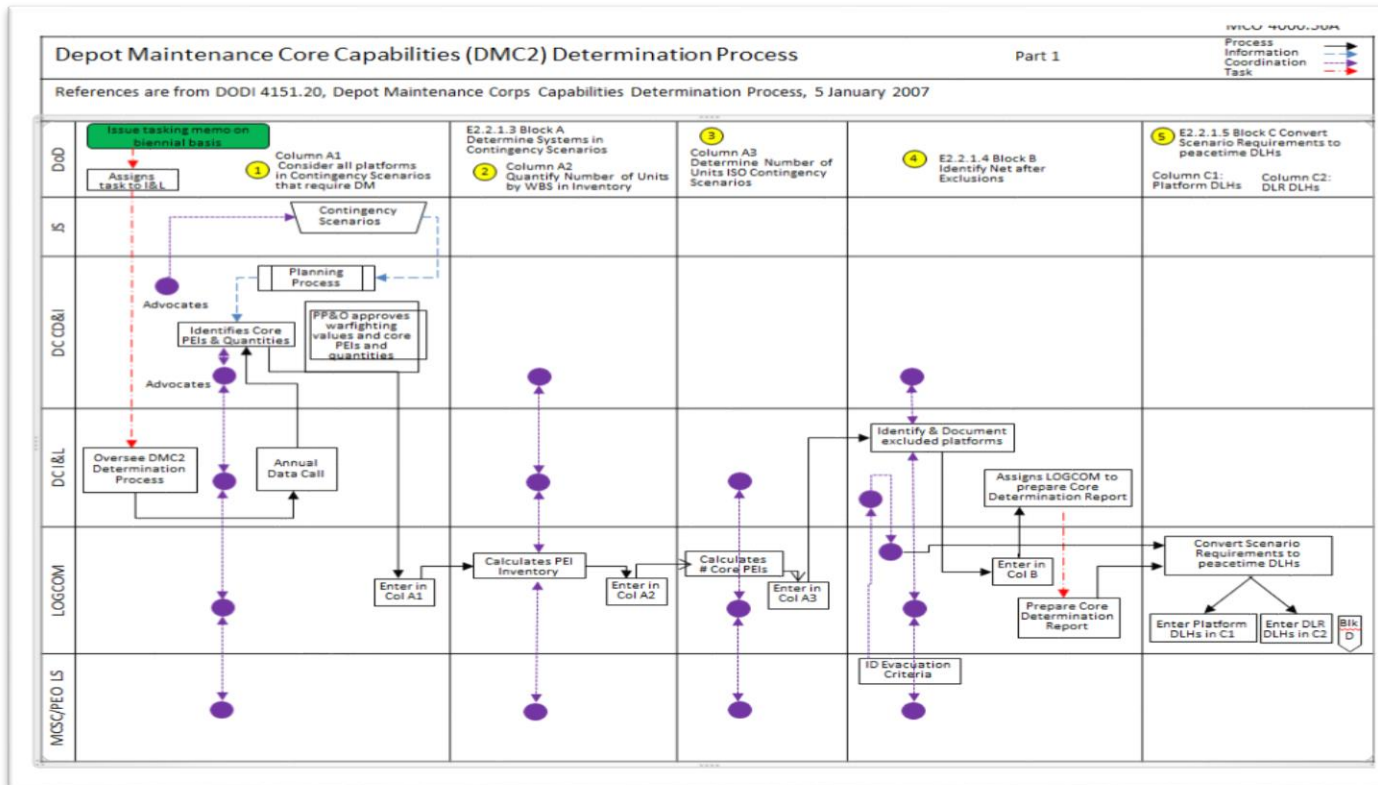

Figure 3-1.--DMC2 Determination Process Chart - Part 1.

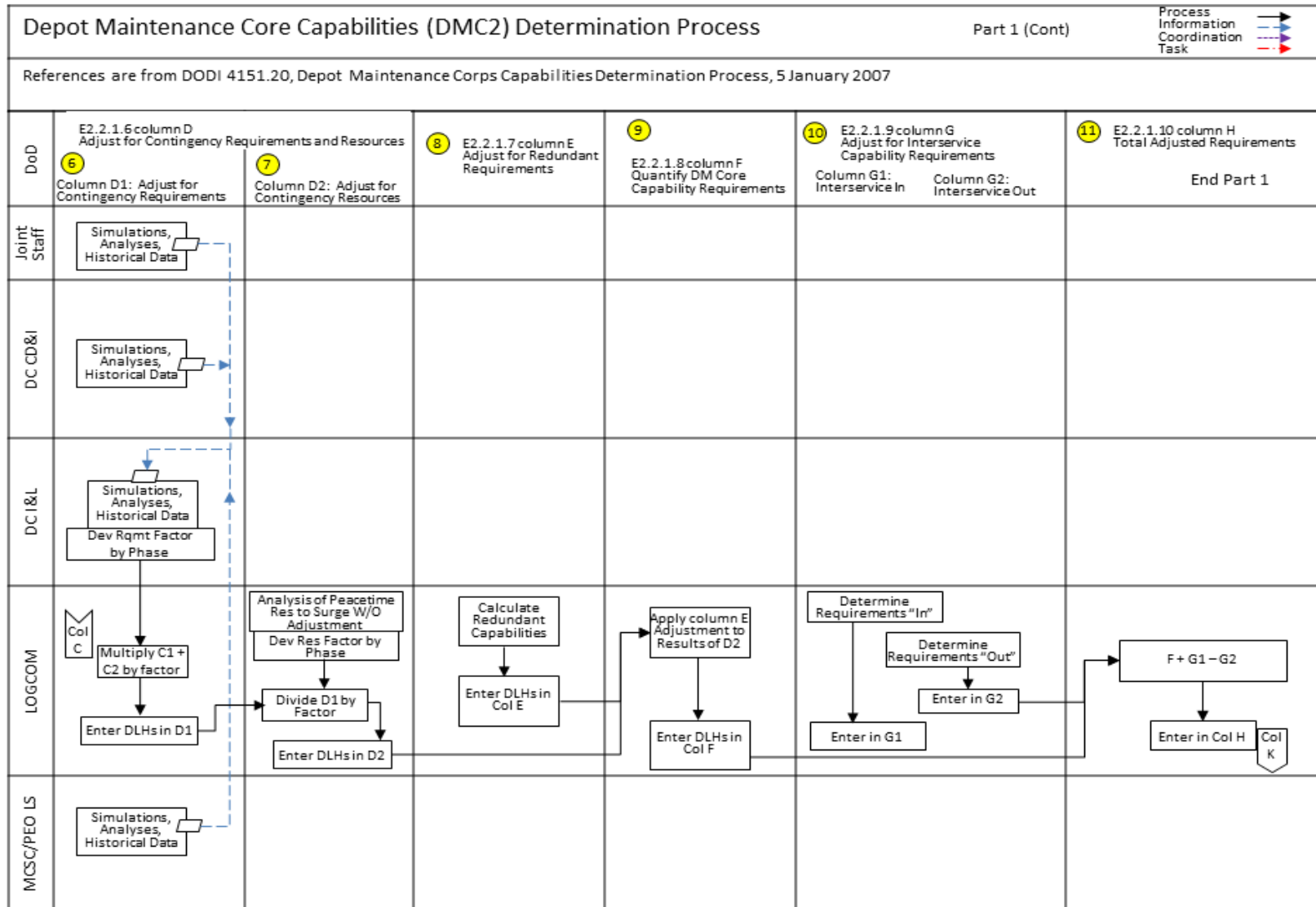

Figure 3-2.--DMC2 Determination Process Chart - Part 1 (Continued)

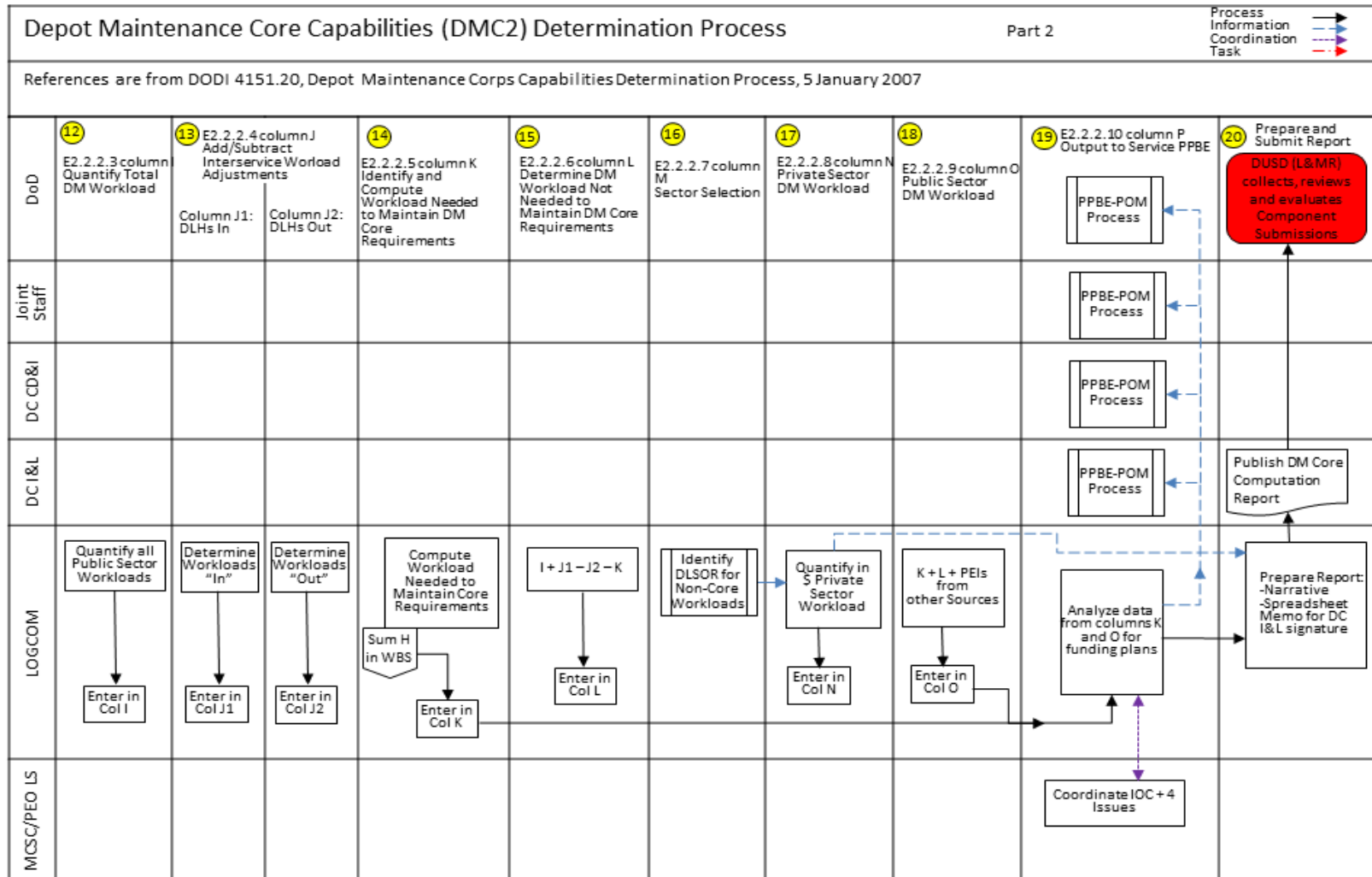

Figure 3-3.--DMC2 Determination Process Chart - Part 2.

New Acquisition Core Determination Process

1. Overview

a. The NACD Process analyzes each new materiel initiative, regardless of Acquisition Category (ACAT) and/or dollar value, for a DM Core Logistics Capability requirement while it is still in the EFDS (as implemented per reference (f)) and/or Defense Acquisition System (reference (g)) phase of development. Reference (a) contains the requirement to establish a DM Core Logistics Capability for assets that "fulfill the strategic and contingency plans prepared by the Chairman of the Joint Chiefs of Staff" and to have the capability in place by IOC plus four years. DoD policy (reference (b)) also directs that maintenance programs be structured for meeting readiness and sustainability objectives of national defense strategic and contingency requirements, and that they be clearly linked to strategic and contingency planning.

b. There are two primary decisions that need to be made in the NACD Process: the DM Core Program determination and the Core Quantity determination.

(1) A materiel initiative is a DM Core Program if it meets both of the following criteria:

(a) The materiel initiative is required to support the contingency scenarios.

(b) The materiel initiative has a DM requirement.

(2) The DM Core Quantity specifies the number of items that are considered DM Core (i.e., the number of items that are required to support the contingency scenarios). In some cases, the entire authorized quantity may be the DM Core Quantity, but generally a portion of the fielded items will not be included in the Core Quantity, such as those used at bases and stations or used at formal training commands.

2. Methodology. The process flows shown in enclosure (5) depict the mainstream events of the NACD Process. The EFDS and Defense Acquisition System processes depend on multiple factors including the capability requirement, the type of proposed program, the technological maturity of the proposed program, and operational requirements. Although these activities are not within the NACD Process, some of them are included to demonstrate the linkage of warfighting requirements to the NACD Process.

a. EFDS. The EFDS, as found in reference (f), is a deliberate, analytical process that is used to identify and prioritize the warfighter's requirements. It is initiated by conducting a Capability Based Assessment (CBA) whereby the Marine Air-Ground Task Force (MAGTF) capability needs are determined, the associated gaps are identified, and recommended strategies for mitigating those gaps are presented to leadership. Guidance extracted from sources such as the National Military Strategy, National Security Strategy, Operational Plans, and Combatant Commanders Requirements, are inputs to the CBA and describe the strategic and contingency scenarios the Marine Corps must support. This provides the first linkage between the EFDS and the NACD Process, as the equipment which is identified as Core is derived from an analysis of the information contained in those sources.

b. NACD Process Step 1. Within the EFDS, as the initiative progresses toward a Materiel Development Decision (MDD), the lead Integration Division (ID) is responsible for writing the appropriate capability document (e.g., Initial Capabilities Document (ICD), Capability Development Document, CPD and Statement of Need). The capability document is the sponsor's means to specify authoritative and testable performance capabilities for the program and include system maintenance/support concepts and usage scenarios.

c. NACD Process Step 2. When the need for a materiel solution has been determined, the JROC/MROC recommends that the MDA consider potential materiel solutions. The MDA, working with appropriate stakeholders, determines whether there is sufficient information to proceed with a MDD. The MDD review is the formal entry point into the Acquisition Process and is mandatory for all programs. Following the MDD, the lead entity for Core determination shifts from CD&I/ID to MCSC and PEO LS.

d. NACD Process Step 3

(1) Following approval of Analysis of Alternatives (AoA) study guidance from the MDA, MCSC prepares an AoA study plan to assess preliminary materiel solutions, identify key technologies, and develop Life Cycle Cost Estimates (LCCEs). The purpose of the AoA is to assess the potential materiel solutions that satisfy the capability requirement. Per reference (g), an AoA is required for Milestone A for all ACATs, and it is updated for Milestone B and Milestone C, as necessary. For materiel solution initiatives that do not yet have a Core Program decision, the AoA will provide enough information about the materiel solution to determine if it will require DM. The PM leads the AoA Process and prepares a DM requirement recommendation for an MDA decision at the MS A review. If a materiel solution enters the Acquisition Process after MS A, the Core Program decision must be made at the first milestone review.

(2) If the MDA decides the materiel solution does not have a DM requirement, then the initiative is not a DM Core Program and the NACD Process terminates.

(3) If the MDA decides the materiel solution does have a DM requirement then the initiative is identified as a DM Core program requirement.

e. NACD Process Step 4

(1) The PM will evaluate the materiel initiative for exception to the DM Core Logistics Capability requirement. Based on paragraphs (a)(3) and (a)(5) of reference (a), systems and equipment can be excluded if they are special access programs, nuclear aircraft carriers, and commercial items that have been sold or leased in substantial quantities to the general public and are purchased without modification in the same form that they are sold in the commercial marketplace, or with minor modifications to meet Federal Government requirements.

(2) If the PM determines that an exception applies, the PM reviews (if the PM is the MDA)/submits the recommendation for exception to the MDA for review. If approved, the recommendation is then forwarded to I&L for a final Marine Corps decision. If approved by I&L, I&L will submit the request for exception to DoD, who takes action for Congressional approval. If the exception is approved by Congress, the initiative is not

a DM Core Program, which terminates the NACD Process for this item. I&L then notifies the stakeholders of the Core exception decision, publishes the decision in appropriate documentation and systems of record, and notifies MCSC and/or PEO LS for inclusion in the LCSP. If any reviewing authority in the process chain determines that the initiative is not an exception, the decision is documented and the PM is notified for inclusion in the LCSP.

(3) The PM continuously updates the LCSP as necessary to support performance requirements. The CLA/SOR Analysis is addressed in the LCSP for all ACATs. The CLA/SOR Analysis is part of the Acquisition Strategy and is required by MS B (or MS C if there is no MS B) for all ACATs, as noted in reference (g). The PM will perform an analysis to determine the maintenance source that complies with statutory requirements (i.e., the DSOR of Core items must be a GO/GO source).

f. NACD Process Step 5. During the annual DMC2 determination process, CD&I will provide all items which have been identified as part of the Core Quantity list to Marine Corps Systems Command who will identify those TAMCNs requiring depot maintenance. If the TAMCN is on the Core Quantity list and requires depot maintenance, then it is designated DM Core along with its DM Core quantity.













g. NACD Process Step 6. The DSOR Process is a process external to the NACD Process because the DSOR is determined regardless of an initiative's DM Core Program and DM Core Quantity determination. The fundamental purpose of DSOR is to decide where DM support for a given program will be performed and how much will be performed at each location. However, the DSOR Process is closely aligned with the NACD Process because the result of the DM Core Program determination and DM Core Quantity determination can affect the DSOR Decision. If a materiel initiative is a DM Core Program, then the number of items that are identified as DM Core (i.e., the Core Quantity) must be maintained at a GO/GO facility; unless waived. Enclosure (1) of reference (d) provides instructions for the DSOR process.

h. NACD Process Step 7. After DM Core Logistics Capability requirements have been determined, the PM is responsible to ensure that the requirements for the establishment of organic capability are included in all product support acquisition requirements (e.g., technical data, peculiar support equipment, facilities, personnel, and/or Public Private Partnership).

New Acquisition Core Determination Process Charts

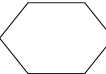
Overview. The NACD Process charts show the flow of information, coordination and data that is necessary to complete the NACD Process. The process charts include the EFDS and Acquisition Process milestones along the top for reference and the horizontal rows show organizational roles and responsibilities. The symbols used in the process charts are shown in Table 5-1. The NACD Process charts are shown in Figures 5-2 and 5-3.

Table 5-1.--Symbols Used in Process Charts.

Symbol	Use	Symbol	Use
	Process Start Point: action that initiates the process		Termination: the point at which the process is complete or monitoring outside this process occurs
	Predefined Marine Corps Process that happens outside the process depicted		Direction of the process depicted
	Action: represents an action taken in the process		Information
	Process/Action outside the Marine Corps		Coordination
	Preparation: action taken to prepare a document or report		Tasking/Direction
	Data: data that is produced or provided		Connector Out/ Connector In: results from one area in the process are transferred to different, non-sequential area in the process

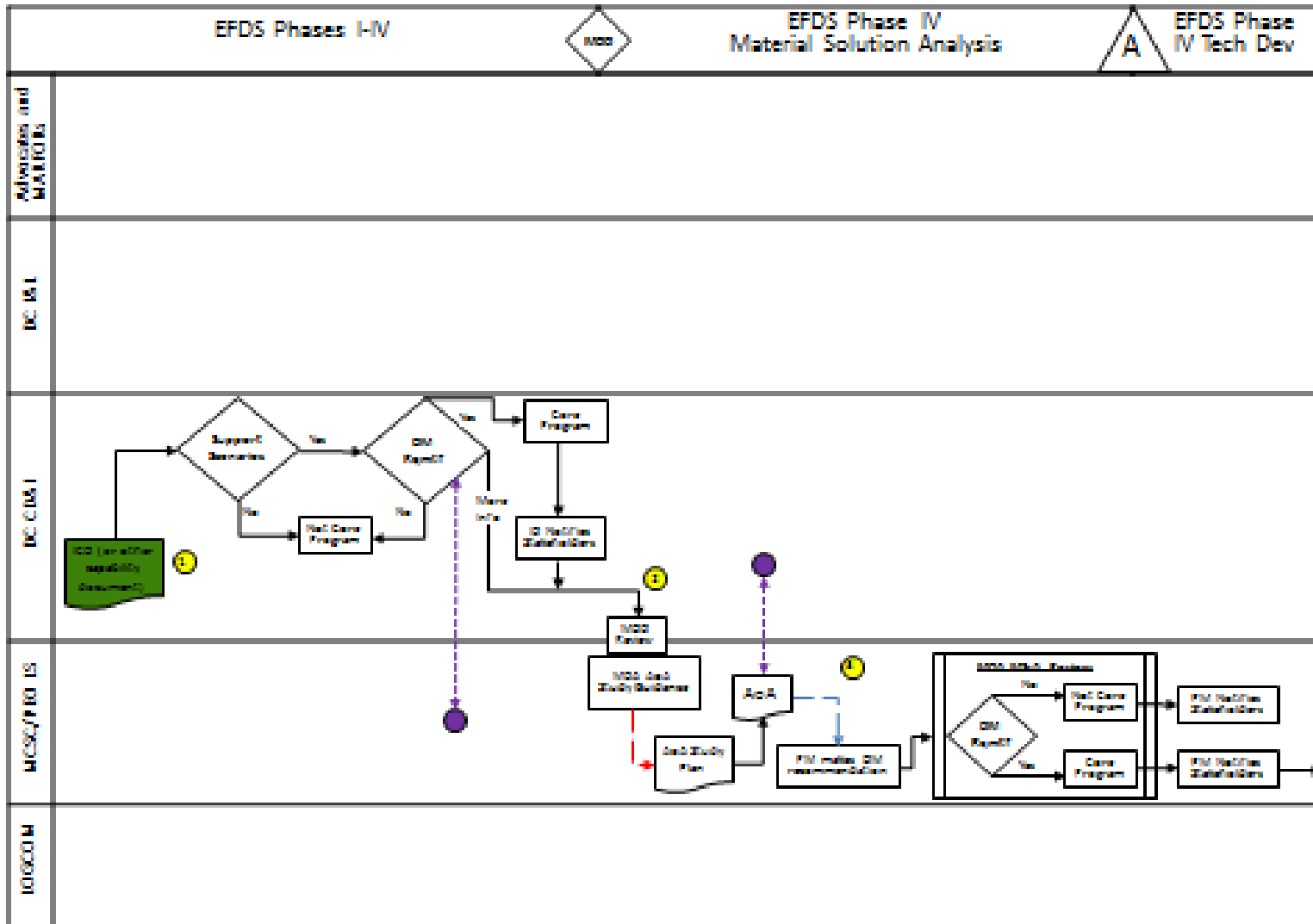

Figure 5-2.--NACD Process Chart

Figure 5-2.--NACD Process Chart.

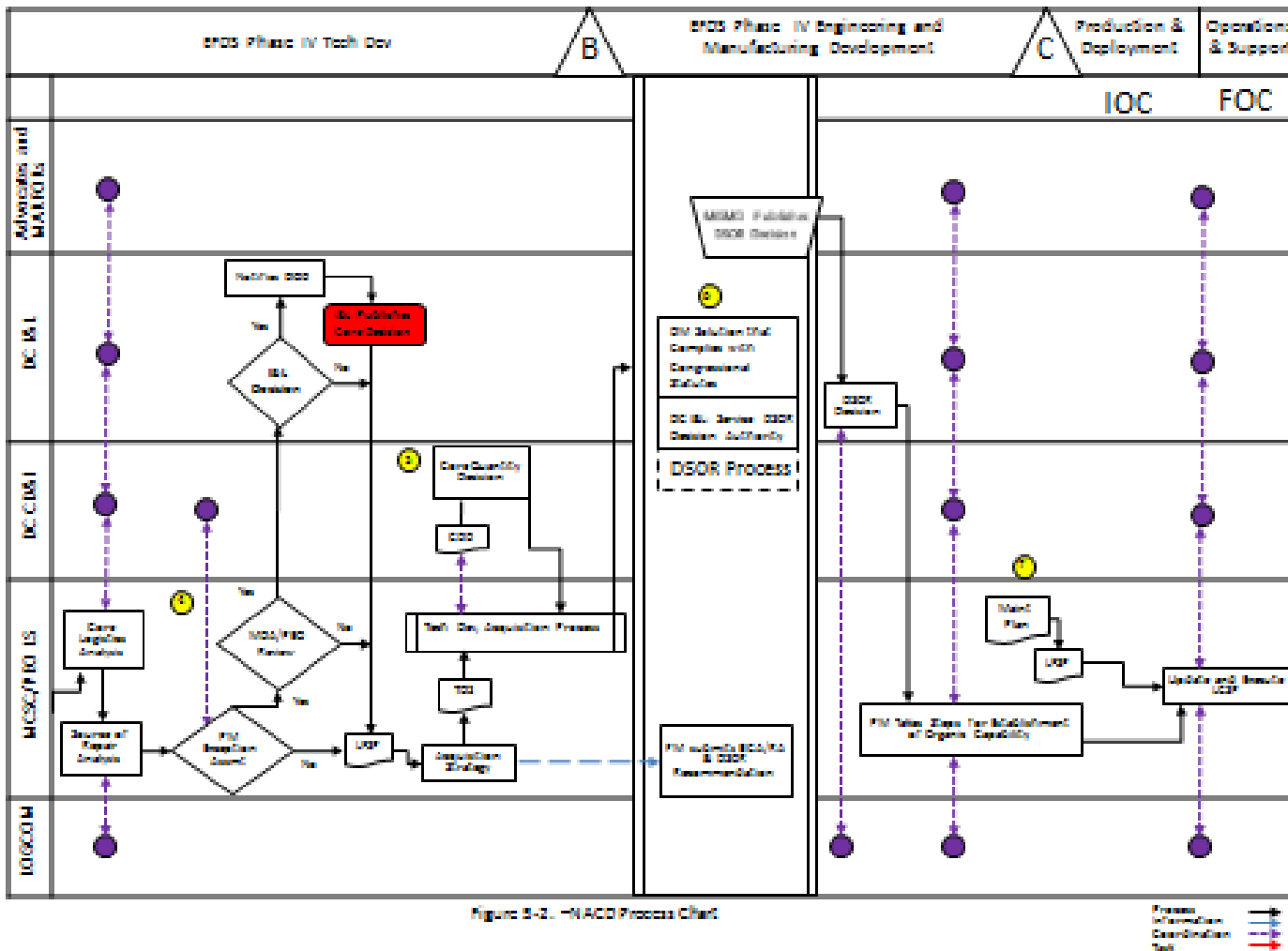

Figure 5-2.--NACD Process Chart

Figure 5-3.--NACD Process Chart (Continued)

05 JAN 2017

Contingency Requirements Factor Methodology

1. Overview

a. As part of the DMC2 Determination Process, per reference (b), HQMC I&L, LPC is responsible for calculating a Service-specific CRF.

b. The CRF represents the increase in the DM Core Logistics Capabilities over peacetime requirements to estimate wartime requirements. Reference (b) provides instructions on how to calculate the factor: "Adjust annual peacetime depot maintenance DLH data by applying a surge factor for requirements during the readiness, sustainment, and reconstitution phases of contingency operations. Base surge factors on contingency simulations, logistics support analyses, and/or historical data for both peacetime and wartime operations."

2. Methodology

a. Most items involved in contingency operations will return to the depot for one of two reasons:

- (1) Regularly scheduled maintenance.
- (2) Combat damage repair.

b. PEIs have a known DM cycle, requiring the PEI/SECREP to periodically return to the depot for maintenance. For most, if not all PEIs, the DM cycle is dependent upon the utilization rate of the PEI (e.g., miles driven, rounds fired, etc.). Parameters obtained from a Reliability Centered Maintenance analysis may also be used in determining the DM cycle, independent of the utilization rate. It is further expected that contingency operations increase the utilization rates of equipment, thereby shortening the time between depot visits. Thus, the intensity of the contingency, measured by its OPTEMPO and the duration of the contingency, will determine its overall impact on depot surge requirements.

c. Additionally, it is expected that PEIs will return to the maintenance depots if they are damaged beyond the repair capabilities of the lower echelons of maintenance. Contingencies may increase the rate in which PEIs return to the depots for repair because of the increased occurrences of combat damage.

d. The methodology for calculating the CRF is found in Figure 6-1.

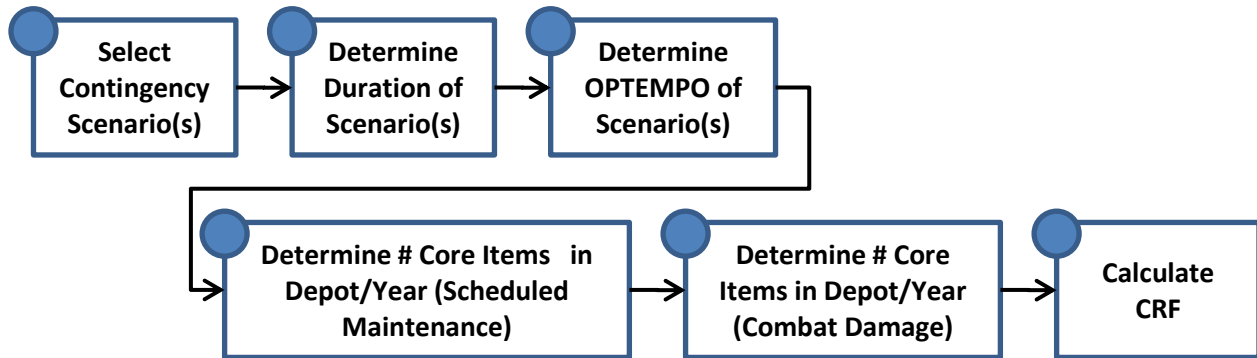

Figure 6-1.--CRF Process.

(1) Step 1: Select Contingency Scenario(s)

(a) The contingency scenarios are the driving force behind the CRF value. A short, low-intensity scenario will yield a smaller CRF than a long, high-intensity scenario.

(b) In developing the DMC2 Determination Report, one of the first steps of the process is for CD&I to provide a force list that supports current contingency scenarios. This force list will be translated into the Depot Level Repairable Equipment List (including quantities) in the DMC2 Determination Report. Therefore, the same contingency scenarios that are provided for the Depot Level Repairable Equipment List should be used to determine the CRF.

(2) Step 2: Determine Duration of the Scenario(s)

(a) The duration of each of the contingency scenarios will affect the impact on DM Core Logistics Capabilities requirements. The longer the contingency (i.e., the longer that equipment is used at a higher OPTEMPO), the greater the impact it will have on DM Core Logistics Capabilities requirements.

(b) Duration can be determined by examining the timeline of events in the narrative that accompanies the contingency scenarios. Scenario duration is the amount of time that units within the scenario are at an increased OPTEMPO. Long-duration scenarios may have several phases (e.g., readiness, sustainment, etc.) in which the OPTEMPO varies. In this case, it may be best to break a long scenario into multiple

phases to better reflect the impact on DM Core Logistics Capabilities requirements.

(3) Step 3: Determine OPTEMPO of the Scenario(s)

(a) Like duration, the OPTEMPO of the contingency scenarios will affect the impact the scenarios will have on DM Core Logistics Capabilities requirements. The higher the OPTEMPO of a scenario (i.e., the more that equipment is utilized), the greater the impact it will have on DM Core Logistics Capabilities requirements.

(b) Determining OPTEMPO of a scenario (relative to peacetime OPTEMPO) can be difficult. While it may be obvious that the OPTEMPO of a contingency scenario is higher than the OPTEMPO of peacetime operations, sometimes quantifying this value is not easy. OPTEMPO can be estimated as a general case across the entire scenario (e.g., OPTEMPO of the scenario is five times peacetime OPTEMPO) or can be calculated by PEI or WBS category (e.g., generators may have a higher OPTEMPO than radios within the scenario).

1. Overall OPTEMPO of the Scenario(s). It is possible that the overall OPTEMPO of each of the scenarios is identified or can be gleaned from the narrative of the scenarios. In this case, the qualitative notion of OPTEMPO can be converted to a quantitative number by estimating the utilization rate of the equipment (e.g., miles driven, rounds fired) relative to peacetime utilization. These utilization rates may be derived using logistics planning factors or historical data for similar operations.

2. OPTEMPO by PEI or WBS Category

a. Another approach is to determine OPTEMPO by PEI or WBS category. For some PEIs, it may be possible to use planning factors for contingency scenario operations found in sources such as reference (h). For example, reference (h) has scenario-independent planning factors for aircraft sortie rates (surge and sustain rates) which can be used to estimate a rough order-of-magnitude OPTEMPO for aircraft-related items.

b. It is also possible to estimate OPTEMPO using operations such as the ones in Afghanistan and Iraq as a surrogate for similar contingencies. This would require comparison of the number of Service Requests for deployed PEIs divided by the average deployed inventory over a given time

period, with the number of Service Requests for non-deployed PEIs divided by the average non-deployed inventory over the same time period. If this method is used for estimating OPTEMPO, the Combat Damage Rate (CDR) factor in the CRF formula should be set to zero since the Service Requests for the deployed units include Service Requests for combat damage. This is due to the fact that combat damage is included in the OPTEMPO and therefore, would be double-counted if a separate CDR factor is included. See Figure 6-2.

$$OPTEMPO = \frac{\text{Number of Service Requests}_{\text{Deployed}} / \text{Average Inventory}_{\text{Deployed}}}{\text{Number of Service Requests}_{\text{Non-deployed}} / \text{Average Inventory}_{\text{Non-deployed}}}$$

Figure 6-2.--OPTEMPO Calculation.

c. An alternative way to estimate OPTEMPO would be to determine fuel burn rates and compare them to peacetime fuel burn rates. Additionally, duty hours for deployed Marines may also provide a means of calculating OPTEMPO. For example, if peacetime duty hours are 40 hours per week, but contingency duty hours are six, 12-hour days, the resulting contingency OPTEMPO is roughly twice that of peacetime OPTEMPO.

(4) Step 4: Determine the Number of DM Core Items in Depot per Year for Scheduled Maintenance

(a) Using the DM cycle or the Evacuation Criteria, the number of Core items that are expected in the depot each year for regularly scheduled maintenance is the total number of Core items divided by the DM cycle (in years), see Figure 6-3:

$$CIE = \frac{\text{Number of Core Items}}{\text{Depot Maintenance Cycle (in years)}}$$

Where: Core Items Expected (CIE) = DM Core items expected in the depot per year for regularly scheduled maintenance.

Figure 6-3.--CIE Definition.

(b) For example, assume there are 130 Marine Corps vehicles of a particular type in the inventory, but only 93 of them are DM Core. Also, assume the vehicle needs depot-level maintenance every 30,000 miles, and that on average in peacetime, vehicles of this type travel 10,000 miles per year. This would result in the vehicle returning to the depot once

every three years. Then the expected number of DM Core items that will return to the depot for regularly scheduled maintenance per year would be (see Figure 6-4):

$$CIE = \frac{93}{3} = 31$$

Figure 6-4.--CIE Example.

(5) Step 5: Determine the Number of DM Core Items in the Depot per Year Due to Combat Damage

(a) To determine the number of items that will return to the depot due to combat damage, determine the combat damage rate and then determine the fraction that would be repairable.

1. Determine the Combat Damage Rate

a. One way to estimate the combat damage rate is to use the CARF. CARF rates are logistics planning factors used to estimate equipment losses in future conflicts and are provided by DC I&L. Reference (i) defines CARF as "...the requirement quantity needed to keep the forces up to their Table of Equipment level in the event assets are destroyed or lost in an operation or contingency." Assault and sustainment CARFs have been developed based on a 30-day conflict, by TAMCN, for three different levels of combat intensity: low intensity, medium intensity, and high intensity. To estimate the number of items that will be destroyed in the contingency, use the CARF rates that best match the intensity of the contingency. To determine the CDR, multiply the CARF rate by the number of Core items and adjust for the length of the contingency (by multiplying by the duration of the contingency in months), see Figure 6-5.

$$CDR = CARF * Number\ of\ Core\ Items * Duration$$

Figure 6-5.--CDR Definition.

b. Using CARF rates in this way assumes that CARF rates include items that are "destroyed or lost" but are still repairable. If CARF rates do not include items that are still repairable, then using CARF rates in this formula may be misrepresenting the CDR.

2. Estimate Fraction Repairable

05 JAN 2017

a. In order to determine the fraction of items that are repairable, it may be easier to determine the fraction of items that are un-repairable. Service Requests may be used for this purpose. A Service Request may indicate an un-repairable item (or "washout") if it has a job status of "39" (indicating a status of "EVC WASH") at closing. However, some un-repairable systems may never have entered the maintenance system (e.g., damage/destruction resulting in un-recoverability) and hence would not have an associated un-repairable Service Request.

b. It is also possible to use Request for Disposition reports to estimate the fraction of items that are un-repairable. A request for disposition is a request to Marine Corps Logistics Base Albany for disposition instructions regarding items that are unserviceable or are excess. The request for disposition contains a remarks field that allows the submitter to specify what is wrong with the item and would allow differentiation between requests for disposition submitted for physically unserviceable items and obsolete or excess items. However, in order to determine the fraction of combat losses that are un-repairable, the total population of combat losses from which the requests for disposition came from would need to be known.

c. In absence of other methods or data sources for estimating the fraction of items that are repairable, it is recommended that the most conservative estimate of 1.0 be used.

(6) Step 6: Calculate CRF

(a) The formula for the CRF is (see Figure 6-6):

$$CRF = \frac{\left[\left(\frac{OP * Dur}{12} + \frac{(12 - Dur)}{12} \right) * CIE + (CDR * Rep) \right]}{CIE}$$

Where:

OP = OPTEMPO of the contingency (relative to peacetime)

Dur = Duration of the contingency

CIE = Core Items Expected in the depot per year for regularly scheduled maintenance

CDR = Combat Damage Rate

Rep = Fraction of items damaged in combat that are repairable

Figure 6-6.--CRF Formula.

(b) The CRF formula includes the two expected causes for items to return to the depot: regular maintenance and combat damage.

(c) The expected number of items returning to the depot for regular maintenance during a contingency is calculated in the first part of the CRF formula (See Figure 6-7):

$$\left(\frac{OP * Dur}{12} + \frac{(12 - Dur)}{12} \right) * CIE$$

Figure 6-7.--CRF Formula (Regular Maintenance).

(d) In this part of the formula, the increased OPTEMPO (*OP*) for the number of months in the contingency (*Dur*) is added to the peacetime OPTEMPO (assumed to be 1) for the remaining number of months in a year ($12 - Dur$) and then averaged over 12 months. This is the expected rate of increase of items returning to the depot for regular maintenance during a contingency. Figure 6-8 displays how a two-month contingency with an OPTEMPO of five times peacetime OPTEMPO would be spread across 12 months.

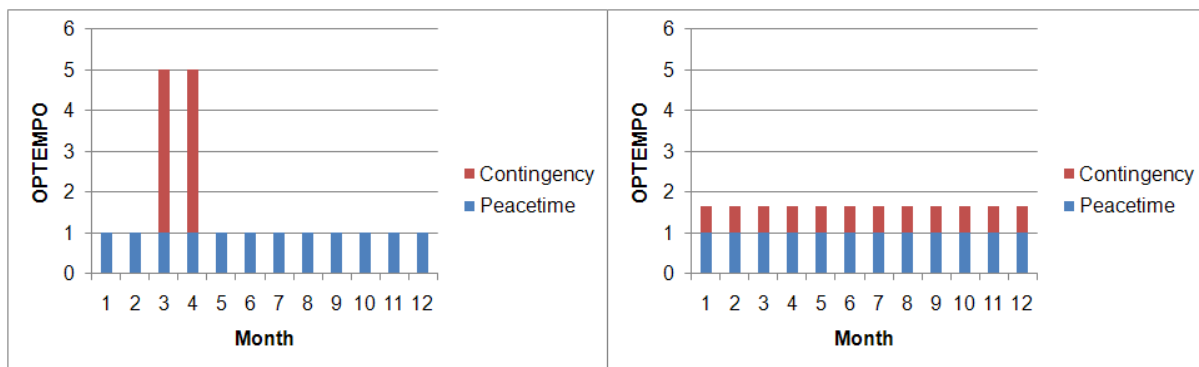

Figure 6-8.--Two-month Contingency OPTEMPO Averaged Over a Year.

(e) This rate is then multiplied by the number of items expected in the depot for regular maintenance during peacetime (*CIE*) to get the expected number of items returning to the depot for regular maintenance during a contingency.

(f) The expected number of items returning to the depot for combat damage in the contingency is the *CDR* multiplied by the fraction of items that are damaged in combat that can be repaired (*Rep*), See Figure 6-9.

*CDR * Rep*

Figure 6-9.--CRF Formula (Combat Damage).

(g) The values for the expected number of items returning to the depot for regular maintenance and for combat damage in the contingency are then divided by the expected number of items returning to the depot for regular maintenance during peacetime (*CIE*) and the expected number of items returning to the depot due to combat damage during peacetime (assumed to be zero), see Figure 6-10.

$$CRF = \frac{\left[\left(\frac{OP * Dur}{12} + \frac{(12 - Dur)}{12} \right) * CIE + (CDR * Rep) \right]}{CIE}$$

Figure 6-10.--CRF Formula (Complete).

(h) Using the previous example of 93 DM Core vehicles expected to return to the depot every three years for regular maintenance (resulting in a *CIE* of 31) assume that the contingency scenario(s) selected indicates an *OPTEMPO* that is five times normal peacetime utilization for that vehicle (e.g., due to mounted patrols and route clearance duties). Also, assume that the duration of the contingency is anticipated to be two months. If the *CARF* for this vehicle is determined to be 0.021 and the estimated fraction of those damaged that are repairable is 40 percent, then the *CRF* will be (see Figure 6-11):

$$CRF = \frac{\left[\left(\frac{5 * 2}{12} + \frac{(12 - 2)}{12} \right) * 31 + ((0.021 * 93 * 2) * 0.40) \right]}{31} = 1.71$$

Figure 6-11.--CRF Example.

(i) The example above illustrates how the *CRF* can be calculated. The resulting factor of 1.71 in the example should not be seen as a standard *CRF* for use in future *DMC2* Determination Reports.

(j) If the duration of the contingency is greater than or equal to 12 months, then the *OPTEMPO* does not need to be averaged over the 12-month period. Therefore, if the contingency is greater than 12 months, the equation becomes (see Figure 6-12):

$$CRF = \frac{[OP * CIE + (CDR * Rep)]}{CIE}$$

Figure 6-12.--CRF (Optempo greater than 12 months).

(k) The previous equations assume that, for the set of contingency scenarios, the surge requirement needs to be accomplished within one year. However, if the assumption is that the surge requirement will be accomplished over a longer (or shorter) period of time than one year, the formula can be changed to accommodate this by adding a factor (*Years*), which accounts for the number of years over which the surge requirement will be accomplished, see Figure 6-13.

$$CRF_{Adj} = \left[\frac{CRF - 1}{Years} \right] + 1$$

Figure 6-13.--CRF (Adjusted).

Resource Adjustment Factor Methodology

1. Overview. As part of the DMC2 Determination Process, each Service has been directed, by reference (b), to calculate a RAF. LOGCOM will be responsible for calculating the RAF. According to reference (b), each Service is to "Apply an appropriate resource adjustment factor (e.g., 1.6) to the DLHs from Column D1 of the worksheet. The factor accounts for the ability of on-hand peacetime DM resources to increase production by operating additional hours without being augmented by additional facilities, equipment, or personnel."

2. Methodology

a. To determine the RAF, the maximum number of additional hours that on-hand peacetime resources can work needs to be determined. In theory, personnel can work a large number of overtime hours; however, factors such as productivity, efficiency, health, and safety may limit the number of overtime hours.

b. Historical data on the number of overtime hours worked at the Marine Depot Maintenance Command would give an upper limit of the number of overtime hours that can be worked (and therefore, the RAF).

c. It is recommended that historical data be analyzed to determine the maximum amount of sustained overtime that is possible. Once that information is gathered, then the appropriate RAF can be determined using the points in Table 7-1.

05 JAN 2017

Table 7-1.--Effective Hours and RAF Calculations Interpolated.

Hours/Week	Efficiency	Effective Hours	RAF
40	100%	40.00	1.00
41	99%	40.59	1.01
42	98%	41.16	1.03
43	97%	41.71	1.04
44	96%	42.24	1.06
45	95%	42.75	1.07
46	94%	43.24	1.08
47	93%	43.71	1.09
48	92%	44.16	1.10
49	91%	44.59	1.11
50	90%	45.00	1.13
51	89%	45.54	1.14
52	89%	46.07	1.15
53	88%	46.59	1.16
54	87%	47.09	1.18
55	87%	47.58	1.19
56	86%	48.05	1.20
57	85%	48.51	1.21
58	84%	48.95	1.22
59	84%	49.38	1.23
60	83%	49.80	1.25
61	82%	49.78	1.24
62	80%	49.72	1.24
63	79%	49.64	1.24
64	77%	49.54	1.24
65	76%	49.40	1.24
66	75%	49.24	1.23
67	73%	49.04	1.23
68	72%	48.82	1.22
69	70%	48.58	1.21
70	69%	48.30	1.21

Terms and Definitions

1. Acquisition Category. Categories established to facilitate decentralized decision-making, execution, and compliance with statutorily imposed requirements. The ACAT determines the level of review, validation authority, and applicable procedures. (CJCSI 3170.01G)

2. Capability. The combination of skilled personnel, facilities and equipment, processes, and technology needed to perform a particular category of work (e.g., composite repair), and that are necessary to maintain and repair the weapon systems and other military equipment needed to fulfill strategic and contingency plans. (DoDI 4151.20, E1.1)

3. Contingency Scenarios. The term used to represent a variety of scenarios that link PEIs to warfighting requirements. The term can include but is not limited to: Joint Chiefs of Staff (JCS) contingency scenarios, DoD-approved scenarios, MROC-Approved Capability Based Analysis scenarios, and Defense Planning Scenarios, as well as references to Concepts of Operations at both the JCS and Marine Corps levels.

4. Core Quantity List. The T/E (by TAMCN and quantity) used in support of the most stringent JCS war fighting scenario. This list is driven by requirements and not by inventory. It is the basis of the DM Core Quantity List, which is the subset of the Core Quantity List generated by CD&I requiring DM and modified for inventory adjustments.

5. DM Core. The depot maintenance capability (including personnel, equipment, and facilities) maintained by the DoD at Government-owned, Government-operated facilities as the ready and controlled source of technical competence and resources necessary to ensure effective and timely response to a mobilization, national defense contingency situations, and other emergency requirements. Depot maintenance for the designated weapon systems and other military equipment is the primary workload assigned to DoD depots to support Core depot maintenance capabilities. (DoD 4151.18-H, AP1.5)

6. DM Core Capability. Those weapon systems and other military equipment (excluding systems and equipment under SAP, nuclear aircraft carriers, and commercial items) that are identified by the Secretary of Defense, in consultation with the Chairman of the Joint Chiefs of Staff, as necessary to enable the armed forces to fulfill the strategic and contingency plans.

7. DM Core Logistics Capability. See "Depot Maintenance Core Logistics Capability."
8. DM Core Program. An initiative that has been identified as having a role in the Marine Corps' execution of the contingency scenarios and having a DM requirement.
9. DM Core Quantity. The number of PEIs required to support the contingency scenarios. The Core Quantity can refer to new acquisitions or PEIs already in service.
10. DM Core Sustaining Workload. Workload, expressed in DLHs, assigned to a DoD depot maintenance activity during peacetime in order to maintain Core capability for specified weapon systems, end items, and components. Core-sustaining workload ensures technical competence in peacetime while preserving the surge capacity and reconstitution capabilities necessary to fully support the strategic and contingency plans prepared by the CJCS. (DoD 4151.18-H, AP1.7)
11. Depot Level Repairable Equipment List. The list of weapon systems and other military equipment (excluding systems and equipment under SAP, nuclear aircraft carriers, and commercial items) that are identified by the Secretary of Defense, in consultation with the Chairman of the Joint Chiefs of Staff, as necessary to enable the armed forces to fulfill the strategic and contingency plans, and that have a DM requirement.
12. Depot Level Source of Repair. (See DSOR)
13. Depot Maintenance. The processes of materiel maintenance or repair involving the overhaul, upgrading, rebuilding, testing, inspection, and reclamation (as necessary) of weapons systems, equipment end items, parts, components, assemblies, and subassemblies. Depot maintenance also includes all aspects of software maintenance, the installation of parts or components for modifications, and technical assistance to intermediate maintenance organizations, operational units, and other activities. Depot maintenance is typically accomplished in fixed shops, shipyards and other shore-based facilities, or by field teams, using more extensive shop facilities, equipment, and personnel of higher technical skill than are available at lower echelons of maintenance. (DoD 4151.18-H, AP1.8)
14. Depot Maintenance Core Capability Determination Process. The process used to identify Core capabilities and execute the DMC2 Determination Report.

15. Depot Maintenance Core Determination Process. The overarching process that encompasses both the DMC2 Determination Process and the NACD Process.
16. Depot Maintenance Core Logistics Capability. The DM capability (including personnel, equipment, and facilities) maintained by the DoD at GO/GO facilities as the ready and controlled source of technical competence and resources necessary to ensure effective and timely maintenance of Core capabilities.
17. Depot Maintenance Core Logistics Capability Requirement. The depot maintenance capability, expressed in DLH, which must be provided by government personnel, equipment, and facilities in compliance with reference (a). (DoD 4151.18-H, AP1.6)
18. Depot Source of Repair. The authorized activity or facility that performs, or is planned to perform, depot level repair on an item.
19. Direct Labor Hour. A common metric for measuring depot maintenance capability, workload, or capacity, representing 1 hour of direct work (e.g., touch labor or other directly attributed effort). (DoDI 4151.20, E1-8)
20. Enterprise Lifecycle Maintenance Program. ELMP is defined as an enhanced, collaborative approach to maintenance planning that expands the existing Depot Level Maintenance Program to include all relevant stakeholders across the Marine Corps. (MCO 4790.24)
21. Exclusions. Specific systems or types of Defense materiel that have been legislatively excluded from Core Logistics Capability requirements computations. Examples include, but are not limited to, materiel supported under SAP and commercial items. (DoDI 4151.20, E1.12)
22. Expeditionary Force Development System. The EFDS is a deliberate, four-phased process that is executed cyclically and is synchronized with the PPBE Process and the Defense Acquisition System. It is a coordinated effort, led by DC CD&I and involving participation in all phases by all DCs/Marine Air-Ground Task Force advocates; Commanders, Marine Forces; DON Deputy Chief Information Officer (Marine Corps), the functional advocates (Director, Intelligence, and Director, Command, Control, Communications, and Computers); and Commander, MCSC. (MCO 3900.15B, Para 4a(2))

23. Joint Capabilities Integration and Development System. JCIDS Process supports the Acquisition Process by identifying and assessing capability needs and associated performance criteria to be used as a basis for acquiring the right capabilities, including the right systems. The primary objective of the JCIDS Process is to ensure the capabilities required by the joint warfighter are identified with their associated operational performance criteria in order to successfully execute the missions assigned. (CJCSI 3170.01G)
24. Maintenance Executive Steering Committee. The Maintenance Executive Steering Committee (MESCC) shall advise the Assistant Deputy Under Secretary (Maintenance Policy and Programs) (ADUSD (MPP)) on initiatives for improving the efficiency, effectiveness and costs of worldwide maintenance management and operations of the DoD. The MESCC shall serve as a mechanism for the coordinated review of maintenance policies, systems, programs, and activities and for jointly planning, monitoring, and evaluating the maintenance program. It will also serve as a forum for the exchange of information among the ADUSD (MPP) and DoD officials responsible for the conduct of maintenance operations in the DoD.
25. Maintenance Interservice Support Management Office. The Marine Corps MISMO is located at LOGCOM, Maintenance Management Center, Albany, GA and is responsible for coordinating all depot maintenance activities under the purview of the Joint Depot Maintenance (JDM) Program.
26. Milestone. Milestones are decision points that initiate programs and authorize entry into the major Acquisition Process phases: Concept and Technology Development, System Development and Demonstration, and Production and Deployment. Milestone decision points typically address program progress and risk, affordability, program trade-offs, Acquisition Strategy updates, and the development of exit criteria for the next phase or effort. (DoD 5000.2-R, April 5, 2002 C7.1 & C7.1.2)
27. New Acquisition Core Determination Process. The process used to designate a new acquisition item as a Core Program and to determine the Core Quantity of that item.

05 JAN 2017

28. Organic. Maintenance performed by a Military Department under military control utilizing Government-owned or controlled facilities, tools, test equipment, spares, repair parts, and military and civil service personnel. Depot maintenance support by one Service for another is considered organic within the DoD.

29. Planning, Programming, Budgeting and Execution. One of three of DoD's principal decision-making support systems along with the JCIDS and the Defense Acquisition System. The PPBE Process is DoD's strategic planning, program development, and resource determination process. The PPBE Process is used to craft plans and programs that satisfy the demands of the National Security Strategy within resource constraints. (Defense Acquisition Guidebook, Chapter 1, Para 1.1)

30. Platform. A weapon system or system of systems or support system designated by a DoD Component as the basis for analysis of Core capability requirements. (DoDI 4151.20, Encl 1, Para E1.16)

31. Private Sector. Infrastructure operated by commercial firms. (DoDI 4151.20, E1.18)

32. Public Private Partnership (or Relationship). An agreement between an organic depot maintenance activity (or its agent) and one or more private industry or other entities to perform work or utilize facilities and equipment. Program offices, inventory control points, and materiel/systems/logistics commands may also be parties to such agreements or be designated to act on behalf of organic depot maintenance activities. (MCO 4790.21, Encl 2, pg. 7)

33. Public Sector. Infrastructure owned and operated by the Federal government. (DoDI 4151.20, E1.19)

34. Surge. The act of expanding an existing depot maintenance repair capability to meet increased requirements by adjusting shifts or by adding skilled personnel, equipment, spares, and repair parts. The expanded capability will increase the flow of repaired or manufactured materiel to the using activity or to serviceable inventory storage. (DoDI 4151.20, E1.24)

05 JAN 2017

35. Work Breakdown Structure. The stratification of work consistent with the hardware element generating the workload (i.e., weapon or equipment end item, system, subsystem, and component). (MCO 4790.10B, Appendix I, pg. 236)

36. Workload. An amount of depot maintenance work, usually specified in DLHs. It relates to specific weapons systems, equipment, components, or programs and to specific services, facilities, and commodities. (DoDI 4151.20, E1.27)

05 JAN 2017

Acronyms

ACAT	Acquisition Category
ACMC	Assistant Commandant of the Marine Corps
AoA	Analysis of Alternatives
CARF	Combat Active Replacement Factor
CD&I	Combat Development & Integration
CDD	Capability Development Directorate
CDD	Capability Development Document
CDR	Combat Damage Rate
CG	Commanding General
CIE	Core Items Expected [in the Depot Per Year]
CJCS	Chairman of the Joint Chiefs of Staff
CJCSI	Chairman of the Joint Chiefs of Staff Instruction
CLA	Core Logistics Analysis
CMC	Commandant of the Marine Corps
CRF	Contingency Requirements Factor
DC	Deputy Commandant
DLH	Direct Labor Hours
DLR	Depot Level Repairable
DLSOR	Depot Level Source of Repair
DM	Depot Maintenance
DMC2	Depot Maintenance Core Capability
DMISA	Depot Maintenance Interservice Support Agreement
DoD	Department of Defense
DoDD	Department of Defense Directive
DoDI	Department of Defense Instruction
DOTMLPF	Doctrine, Organization, Training, Materiel, Leadership and Education, Personnel and Facilities
DSOR	Depot Source of Repair
EFDS	Expeditionary Force Development System
ELMP	Enterprise Lifecycle Maintenance Program
GO/GO	Government-Owned/Government-Operated
HQMC	Headquarters, Marine Corps
I&L	Installations and Logistics
ICD	Initial Capabilities Document
ID	Integration Division
ILS	Integrated Logistics Support
IOC	Initial Operational Capability
JCIDS	Joint Capabilities Integration and Development System
JCS	Joint Chiefs of Staff
JGDM	Joint Group on Depot Maintenance
JROC	Joint Requirements Oversight Council
LCCE	Life Cycle Cost Estimate
LCSP	Life-Cycle Sustainment Plan

LPC	Logistics Policy and Capabilities
MAGTF	Marine Air-Ground Task Force
MARFOR	Marine Forces
MCL	MAGTF Capabilities List
LOGCOM	Marine Corps Logistics Command
MCO	Marine Corps Order
MCSC	Marine Corps Systems Command
MDA	Milestone Decision Authority
MDD	Materiel Development Decision
MESC	Maintenance Executive Steering Committee
MISMO	Maintenance Interservice Support Management Office
MRL	MAGTF Requirements List
MROC	Marine Requirements Oversight Council
MS	Milestone
MSTP	MAGTF Staff Training Program
NACD	New Acquisition Core Determination
OPTEMPO	Operational Tempo
OSD	Office of the Secretary of Defense
PEI	Principal End Item
PEO LS	Program Executive Officer Land Systems
PL	Strategy and Plans Division
PM	Program Manager
POM	Program Objective Memorandum
POR	Program of Record
PP&O	Plans, Policies & Operations
PPBE	Planning, Programming, Budgeting, and Execution
RAF	Resource Adjustment Factor
SAP	Special Access Programs
SOR	Source of Repair
TAMCN	Table of Authorized Material Control Number
TE	Table of Equipment
USD AT&L	Under Secretary of Defense (Acquisition, Technology and Logistics)
WBS	Work Breakdown Structure
WIR	Recoverable Items Reports