

**VOLUME 2**

**“DEPARTMENT OF DEFENSE ACTIVITY ADDRESS CODE”**

**SUMMARY OF VOLUME 2 CHANGES**

Hyperlinks are denoted by ***bold, italic, blue and underlined font.***

The original publication date of this Marine Corps Order (right header) will not change unless/until a full revision of the MCO has been conducted.

The date denoted by **blue font** (left header) will reflect the date this Volume was last updated.

All Volume changes denoted in **blue font** will reset to black font upon a full revision of this Volume.

<b>VOLUME VERSION</b>	<b>SUMMARY OF CHANGE</b>	<b>ORIGINATION DATE</b>	<b>DATE OF CHANGES</b>
ORIGINAL VOLUME	N/A	DD MMM YYYY	N/A

Submit recommended changes to this Volume, via the proper channels, to:

CMC (LPC-2)  
 3000 Marine Corps Pentagon  
 Washington, DC 20350-3000

**VOLUME 2: DEPARTMENT OF DEFENSE ACTIVITY ADDRESS CODE**

**TABLE OF CONTENTS**

<b>REFERENCES.....</b>	<b>REF-1</b>
<b>CHAPTER 1: GENERAL OVERVIEW .....</b>	<b>1-1</b>
0101 GENERAL .....	1-2
0102 TERMS .....	1-2
0103 DEPARTMENT OF DEFENSE ACTIVITY ADDRESS DIRECTORY .....	1-5
<b>CHAPTER 2: ROLES AND RESPONSIBILITIES .....</b>	<b>2-1</b>
0201 GENERAL .....	2-2
0202 DEFENSE LOGISTICS MANAGEMENT STANDARDS OFFICE .....	2-2
0203 DEFENSE LOGISTICS AGENCY TRANSACTION SERVICES .....	2-2
0204 DEFENSE FINANCE AND ACCOUNTING SERVICE .....	2-2
0205 HEADQUARTERS, UNITED STATES MARINE CORPS .....	2-2
0206 COMMANDERS, MARINE CORPS FORCES .....	2-7
0207 SUPPORTING ESTABLISHMENT .....	2-7
0208 INDIVIDUAL COMMANDS AND ACTIVITIES .....	2-9
0209 MAJOR COMMAND DODAAC MONITORS .....	2-9
0210 MARINE CORPS CONTRACTING OFFICERS .....	2-10
<b>CHAPTER 3: DEPARTMENT OF DEFENSE ACTIVITY ADDRESS CODE</b>	
<b>ESTABLISHMENT .....</b>	<b>3-1</b>
0301 UNITED STATES NAVY .....	3-2
0302 UNITED STATES MARINE CORPS .....	3-3
<b>CHAPTER 4: DEPARTMENT OF DEFENSE ACTIVITY ADDRESS CODE</b>	
<b>MANAGEMENT .....</b>	<b>4-1</b>
0401 THE DODAAC MANAGEMENT PROCESS .....	4-2
0402 ROLE-BASED PROCESS .....	4-2
0403 DODAAC REQUESTS .....	4-3

0404	TYPES OF REQUESTS .....	4-3
0405	DODAAC VALIDATION AND MAINTENANCE.....	4-6
0406	DODAACS AND ORGANIZATIONAL CHANGE MANAGEMENT.....	4-7
<b>CHAPTER 5: UNIT DEPLOYMENTS.....</b>		<b>5-1</b>
0501	ORIGINATION .....	5-2
0502	PLANNING FACTORS .....	5-2
0503	TERMS .....	5-2
0504	DODAAC/UIC DATA ALIGNMENT .....	5-3
0505	TYPES OF DEPLOYMENTS .....	5-3
<b>CHAPTER 6: DODAAC CHARACTERISTICS AND DATA .....</b>		<b>6-1</b>
0601	GENERAL .....	6-1
0602	DODAAC DATA FIELDS .....	6-1
0603	EXAMPLES.....	6-14
0604	DODAAC AND RIC QUERIES .....	6-15
<b>CHAPTER 7: ROUTING IDENTIFIER CODE CHARACTERISTICS AND DATA.....</b>		<b>7-1</b>
0701	ROUTING IDENTIFIER CODES.....	7-2
0702	PURPOSE .....	7-2
0703	RIC DATA FIELDS .....	7-2
<b>CHAPTER 8: DODAACS AND UICS.....</b>		<b>8-1</b>
0801	GENERAL .....	8-2
0802	AUTHORITY .....	8-2
0803	DODAAC USES.....	8-2

**VOLUME 2: DEPARTMENT OF DEFENSE ACTIVITY ADDRESS CODE**

**TABLE OF CONTENTS**

**APPENDICES**

A	APPROPRIATIONS, FUNDS, AND ACCOUNTING CLASSIFICATION .....	A-1
B	DOCUMENT NUMBERS .....	B-1
C	MAJOR COMMAND CODES .....	C-1
D	DODAAC AUTHORITY CODES .....	D-1
E	USMC DODAAC ASSIGNMENT LOGIC .....	E-1
F	NAVMC 11718 "USMC DODAAC / RIC REQUEST FORM" .....	F-1
G	NAVY UIC - DODAAC REQUEST .....	G-1
H	ADDITIONAL CRIF GUIDANCE .....	H-1
I	DODAAC PROCESSES AND SYSTEMS .....	I-1

**REFERENCES**

- (a) MCO 5311.1D
- (b) Title 31 United States Code (U.S.C.)
- (c) DoD Directive 4140.1, "Materiel Management Policy."
- (d) DoD FMR 7000.14-R, "Department of Defense Financial Management Regulation"
- (e) DoD 4000.25-6-M, "Department of Defense Activity Address Directory,"
- (f) DLM 4000.25-1, "Military Standard Requisitioning and Issue Procedures (MILSTRIP), Appendix 2.2 - Service and Agency Codes."
- (g) DLM 4000.25 "Defense Logistics Management System (DLMS)"
- (h) MCO 4400.203
- (i) MCO 4610.37F
- (j) MCO 7010.19
- (k) MCO P4400.82F
- (l) Title 10, United States Code (U.S.C.), as amended through Jan 7, 2011
- (m) Marine Corps Manual (MARCORMAN), 21 Mar 1980, as amended
- (n) DoD Manual 4525.8-M "Official Mail Manual"
- (o) DoDM 4140.01 "Supply Chain Materiel Management Procedures"
- (p) DLM 4000.25, Vol 6 "Logistics Systems Interoperability Support Services
- (q) DTR 4500.9-R, "Defense Transportation Regulation (DTR)"
- (r) Marine Corps Reference Publication (MCRP) 5-12D "Organization of Marine Corps Forces"
- (s) DLMS Memo, "ADC 226, Revision of MILSTRIP, MILSBILLS and DLMS to add Authority Code edits Supply/Finance/MILSTRIP/MILSBILLS/DoDAAC)", March 1, 2007
- (t) Manual for Courts-Martial
- (u) MCO 4470.1a
- (v) DLM 4000.25-4 "Defense Automatic Addressing System (DAAS)"
- (w) MCO 4600.7
- (x) DFARS PGI 204.201 "Contract Distribution"
- (y) DFARS PGI 204.270 "Electronic Document Access"
- (z) DoD 4000.25-2-M "Military Standard Transaction Reporting and Accounting Procedures"
- (aa) Federal Acquisition Circular 2001-26

**VOLUME 2: CHAPTER 1**

**“GENERAL OVERVIEW”**

**SUMMARY OF SUBSTANTIVE CHANGES**

Hyperlinks are denoted by ***bold, italic, blue and underlined font.***

The original publication date of this Marine Corps Order (MCO) Volume (right header) will not change unless/until a full revision of the MCO has been conducted.

All Volume changes denoted in **blue font** will reset to black font upon a full revision of this Volume.

<b>CHAPTER VERSION</b>	<b>PAGE PARAGRAPH</b>	<b>SUMMARY OF SUBSTANTIVE CHANGES</b>	<b>DATE OF CHANGE</b>

**CHAPTER 1**

**GENERAL OVERVIEW**

0101 GENERAL

This Volume provides updated policy and procedures for the management of Marine Corps Department of Defense Activity Address Codes (DoDAACs). It ensures that the Marine Corps' portion of the Department of Defense Activity Address Directory (DoDAAD) is accurately maintained, that systems which use DODAAC data are properly aligned, and that effective internal controls are in place per DoD regulations. This policy also directs the management of Marine Corps Routing Identifier Codes (RICs) and provides the criteria and requirements for establishing, updating, or deleting DoDAACs and RICs. Adherence to the provisions established in this policy will facilitate greater fidelity in fiduciary and pecuniary responsibilities, as well as greater accuracy in the accountability of equipment.

0102 TERMS

010201. General

The proper identification of a command, agency, activity, or unit is critical in the Marine Corps. Most often, a unit's identity is associated with its name. Headquarters, U.S. Marine Corps (HQMC) is the namesake for the highest echelon of command within the Marine Corps; however, in order to identify HQMC within various information systems, an abbreviated identifier is created and used to represent the organization. Each of the systems upon which we rely to conduct critical business operations across the Marine Corps require some means other than a unit's name to properly identify Marine Corps organizations. Just as a Social Security Number (SSN) is used to identify a person in various systems, unit identifiers are used to identify commands, agencies, activities, and units within various systems.

010202. Unit Identifiers

The Marine Corps uses various codes to represent the identity of a unit within Marine Corps information systems. There are several five and six-position unit identifiers which must not be confused. Each has a particular function within the system for which it was created. The following unit identifiers are most commonly used within the Marine Corps.

A. Unit Identification Code

Unit Identification Codes (UICs) are assigned by different agencies for different purposes. The following UICs are used within Marine Corps information systems to ensure proper execution of readiness reporting, equipment accountability, and financial management.

1. Financial UIC. A financial UIC is a five-digit numeric identifier which is used for financial reporting. For all units of the Department of the Navy (DON), the Navy Financial Management & Comptroller (FM&C) Office is responsible for assigning and maintaining a record of all financial UICs. The Defense Finance and Accounting Service (DFAS) is the executive agent who carries out this function on behalf of the Department of the Navy Financial Management and

Comptroller (DON FM&C). A financial UIC is used for any Marine Corps command/activity that uses Navy financial management systems. Activities using Operations and Maintenance, Marine Corps (O&M MC) funds are designated by a Marine Corps DoDAAC. For Operations and Maintenance, Navy (O&M N) funds, organizations are identified by a Navy DoDAAC. Activities with Marine Corps DoDAACs at the Operational Budget (OPBUD) or Sub-Operating Budget (SUBOPBUD) levels (a.k.a. Allotment Recipient Identifier (ARI) or Sub-Allotment Recipient Identifier (SRI) levels) must first be registered as financial UICs with DFAS. The Deputy Commandant for Installations and Logistics (DC I&L) performs this action by requesting a UIC from DFAS. The Marine Corps uses this five-digit, numeric identifier in its financial systems by adding an "M" at the beginning, which creates the DoDAAC. The DoDAAC is then loaded to Standard Accounting Budget and Reporting System (SABRS) by the Deputy Commandant, Programs & Resources (DC P&R) Accounting and Financial Systems Branch (RFA) for use as a financial UIC. This occurs only if the unit is planned to operate at the OPBUD (ARI) or SUBOPBUD (SRI) levels and will have an "M" DoDAAC. If the unit is below this level, a DoDAAC is created for the unit without first obtaining a five-digit UIC from DFAS. If a Marine unit requires a Navy DoDAAC, it must first be registered as a financial UIC with DFAS prior to the creation of the Navy DoDAAC.

2. Bureau Code Number. A Bureau Code Number (BCN) is a five-digit, numeric field used to identify the holder of the funds or OPBUD. The BCN for O&M MC appropriation will be the financial UIC code assigned to the allotment authorization (formerly OPBUD or SUBOPBUD) provided to commands. For example, III Marine Expeditionary Force (MEF's) financial UIC "67438" appears as the BCN for the 3rd Marine Division, 3rd Marine Logistics Group (MLG), and 1st Marine Aircraft Wing, because III MEF is the SUBOPBUD holder for all three major commands (MAJCOMs). For allotment holders, the first two alpha-numeric digits of the BCN are the budget project, and the last three numeric digits are the allotment holder. In the Marine Corps, a BCN is an SRI. See Appendix A for additional information.

3. Total Force Structure Management System UIC. A Total Force Structure Management System (TFSMS) UIC is a six-position alpha-numeric identifier which is created by the Deputy Commandant, Combat Development & Integration (DC CD&I), Total Force Structure Division (TFSD) for Navy and Marine Corps organizations (as per reference [\(a\)](#)). It is not the same as a five-digit financial UIC. The TFSMS UIC associates manpower and equipment requirements to the organization in accordance with the organization's wartime (core) mission and approved unit Table of Organization and Equipment (TO&E).

4. Plans, Policies, and Operations, Readiness Branch UIC (PP&O POR UIC). A PP&O POR UIC is a six-position alpha-numeric identifier created by the Deputy Commandant, Plans Policies & Operations (DC PP&O) Readiness Branch (POR). Temporary units such as provisional units that are designated readiness-reportable in Defense Readiness Reporting System Marine Corps (DRRS-MC) use a DC PP&O POR UIC. Permanent units resident in TFSMS that are designated readiness-reportable in DRRS-MC use a TFSMS UIC. The numbers of these provisional units change depending upon operational requirements.



B. Reporting Unit Code

Reporting Unit Codes (RUCs), like financial UICs, are five-position, numeric identifiers. RUCs are created by the Deputy Commandant, Manpower and Reserve Affairs (DC M&RA) to identify a unit, activity, or sub-reporting unit for manpower reporting in Marine Corps Total Force System (MCTFS). RUCs are also assigned to identify echelons of commands that may not submit unit diaries (e.g., division, regiment, aircraft wing, and aircraft group). Personnel assignments and reporting are based not only on the RUC but also on the Monitored Command Code (MCC); a three-digit code used for personnel assignments.

**Note:** A RUC is not the same as a DoDAAC or UIC.

C. Department of Defense Activity Address Code

A DoDAAC is a six-position, alpha-numeric identifier which is created by the Marine Corps Central Service Point (CSP) at DC I&L and is used extensively throughout logistics and financial information systems. The DoDAAC is used by DC P&R as a UIC within the Marine Corps' financial reporting systems (i.e., SABRS and the Programming and Budget Documentation Database (PBDD)). The following are some common uses of a DoDAAC:

1. Major Command Recipient Identifier. A MAJCOM Recipient Identifier (MRI) is a DoDAAC used in SABRS to identify a command that receives funds directly from HQMC. MAJCOM Recipients may pass funds to Allotment Recipients within their command. Examples of MAJCOM Recipients are Commander, U.S. Marine Corps Forces Pacific; Commander, U.S. Marine Corps Forces Command; Commander, Marine Corps Logistics Command (MARCORLOGCOM); and Commander, Marine Corps Combat Development Command.

2. Allotment Recipient Identifier. An ARI is a DoDAAC used in SABRS to identify a command that receives an allotment or OPBUD from an MRI. Examples of ARIs are Commander, Marine Corps Installations East, and Commander, Marine Corps Installations West. MRIs are also ARIs when they pass funds to themselves. An example of an MRI that passes funds to itself as an ARI is Commander, Marine Corps Forces Pacific.

3. Sub-allotment Recipient Identifier. An SRI is a DoDAAC used in SABRS to identify a subordinate command that receives a portion of an allotment or OPBUD from an ARI. Examples of SRIs are Marine Corps Air Station Miramar, Marine Corps Base Camp Pendleton, and I MEF. MAJCOM Recipients are also Allotment/Sub-allotment Recipients when they pass funds to themselves. An SRI is the lowest level at which legal responsibility (as per reference (b)) can be passed. See also financial UIC above.

4. Work Center Identifier. A Work Center Identifier (WCI) is a DoDAAC used in SABRS to identify a subdivision of an SRI. These activities are held administratively responsible for funds management.

5. Major Activity Command. A Major Activity Command (MAC) is a six-position alpha-numeric code used to identify a command that has received funds through an OPBUD or SUBOPBUD, or has significant administrative control and influence on the use of authorized funds within the command. The MAC is the same as the WCI. The MAC identifies the unit

electronically for accounting and reporting purposes and is constructed by using an "M" (Marine Corps) in position one, followed by the five-digit UIC.

6. Activity Address Code. An Activity Address Code (AAC) is an archaic term still used within certain legacy systems, as well as in SABRS. In SABRS, it is used to identify DoDAACs with authority code 00. The more widely used term is DoDAAC.

7. Business Partner Number. The Office of the Secretary of Defense (OSD) implemented the Business Partner Number (BPN) in 2003 to identify federal agencies and DoD activities with requisition authority that enter into agreements with one another for the purpose of acquiring materials and services. Activities must identify themselves with a unique BPN on all intra-governmental transactions. All BPNs for DoD activities are listed in the Federal Registry (FedReg) System with each BPN containing the six-character DoDAAC unique to its activity. As such, accurate DoDAAC assignment and management is critical as FedReg pulls information automatically from the DoDAAD.

8. Document Numbers. A document number is used to uniquely identify a specific transaction derived from a source document for recording, tracking, and management purposes. Per reference (d), Resource Managers are responsible for document number management as well as maintenance of the source documents for which the document numbers were created. There are three types of document numbers used: the Standard Document Number, Military Standard (MILS) Requisitioning and Issue Procedures (MILSTRIP) Document Number, and Procurement Instrument Identification Number (PIIN). See Appendix B.

D. Routing Identifier Code (RIC)

A RIC is a three-digit code used to identify an activity for the purpose of routing logistics transactions. Every RIC is associated to a DoDAAC, but not every DoDAAC associates to a RIC.

0103 DEPARTMENT OF DEFENSE ACTIVITY ADDRESS DIRECTORY

The DoDAAD is a set of interactive database tables, sometimes referred to as the DoD Activity Address File (DoDAAF) which is managed by Defense Logistics Agency Transactions Services (DLA TS), formerly known as the Defense Automatic Addressing System Center (DAASC). It is the single authoritative data source (ADS) for address information for DoD component application systems' data requirements. These data requirements are fulfilled by the use of DoDAACs. As such, the DoDAAD contains all DoDAACs used throughout the DoD and is the official repository for both DoDAACs and RICs. Policy governing the DoDAAD is published in reference (e) under the authority of reference (c) DLA TS is responsible for editing, routing, and electronic transmission of logistics transactions to the military services, federal agencies, and contractors.

010301. The DoDAAD is a collection of addresses and alpha-numeric codes which identify units and organizations throughout the defense establishment, along with certain governmental agencies and civilian contractors which requisition, contract for, ship, or receive materiel/services; fund/pay bills; and/or account for DoD-owned supplies and materiel under the Defense Logistics Management System (DLMS).

010302. The DoDAAD system provides identification codes, clear text addresses, and selected data characteristics of organizational activities needed for requisitioning, marking, shipping document preparation, billing, and similar applications. The DoDAAD is used by all DoD components and by the General Services Administration (GSA).

010303. The DoDAAD is an interactive relational database that stores identification, routing, address and other information for authorized use, including military components and agencies, participating federal agencies, authorized contractors, and authorized special program activities, such as state and local governments. The DoDAAD supports business application system's data and interoperability requirements, including (but not limited to) supply chain, materiel management, distribution, transportation, maintenance, finance, and acquisition systems. Among other uses, DoDAAD information is used throughout the federal supply system for identification, requisitioning, shipping and billing.

010204. The DoDAAD is comprised of DoDAACs, which may be referentially linked to RICs. DoDAAC and RIC assignment is based on service and agency codes identified in reference [\(f\)](#). A unit, activity or organization may have more than one DoDAAC for different purposes.

**VOLUME 2: CHAPTER 2**

**“ROLES AND RESPONSIBILITIES”**

**SUMMARY OF SUBSTANTIVE CHANGES**

Hyperlinks are denoted by ***bold, italic, blue and underlined font.***

The original publication date of this Marine Corps Order (MCO) Volume (right header) will not change unless/until a full revision of the MCO has been conducted.

All Volume changes denoted in **blue font** will reset to black font upon a full revision of this Volume.

<b>CHAPTER VERSION</b>	<b>PAGE PARAGRAPH</b>	<b>SUMMARY OF SUBSTANTIVE CHANGES</b>	<b>DATE OF CHANGE</b>

**CHAPTER 2**

**ROLES AND RESPONSIBILITIES**

**0201 GENERAL**

Management of the DoDAAD is a concerted effort between many DoD agencies and services that are registered within the DoDAAD. Each service and agency is required to maintain its portion of the DoDAAD accurately to ensure compliance with standard policy and procedures. For the Marine Corps, the responsibility for proper DoDAAD management requires a coordinated effort on the part of many internal and external stakeholders as outlined below.

**0202 DEFENSE LOGISTICS MANAGEMENT STANDARDS OFFICE**

The Defense Logistics Management Standards Office (DLMSO) serves as the DoD executive agent for logistics information exchange, and serves as a DoD enterprise service provider supporting the OSD Supply Chain Integration Office, the OSD Defense Procurement and Acquisition Policy Office, and the OSD Comptroller Office. The DLMSO is responsible for administering DoD policy regarding the management of logistics transactions supported by both the Defense Logistics Standard Systems (DLSS) and DLMS. It is also responsible for establishing DoDAAD policy through the DoDAAD Process Review Committee (PRC).

**0203 DEFENSE LOGISTICS AGENCY TRANSACTION SERVICES**

DLA TS is the official repository for DoDAACs and RICs and is responsible for maintaining DoDAACs in the DoDAAD. DLA TS is also responsible for editing, routing, and transmitting electronic logistics transactions to the military services, federal and civil agencies, and contractors.

**0204 DEFENSE FINANCE AND ACCOUNTING SERVICE**

DFAS is responsible for validating billing information for DoDAAC accounts billed through their service centers. DFAS also serves as the DON FM&C executive agent for the assignment of DON financial UICs and DoDAACs. DFAS maintains the DON UIC table for all Navy and Marine Corps financial management operations.

**0205 HEADQUARTERS, UNITED STATES MARINE CORPS**

The DoDAAD facilitates both logistics and financial business processes within the Marine Corps. Though developed collaboratively across all functional DoDAAD stakeholders, the policy for managing the Marine Corps' portion of the DoDAAD is published on behalf of HQMC by DC I&L. HQMC responsibilities for managing the DoDAAD are provided below.

020501. Director, Marine Corps Staff

The Director, Marine Corps Staff (DMCS) establishes management controls over activities under his purview that are registered in the DoDAAD, and ensures that they are operating in compliance with this policy. The supply officer of Headquarters and Service Battalion, HQMC (a.k.a. the HQMC Supply Officer) will serve as the MAJCOM DoDAAC monitor for HQMC DoDAACs (MAJCOM C1).

020502. Deputy Commandant, Installations and Logistics

DC I&L is responsible to the Commandant of the Marine Corps (CMC) for establishing logistics policy and serves as the CMC agent responsible for DoDAAC/RIC management. As the DoDAAC manager of the Marine Corps, DC I&L ensures that the provisions of this policy are implemented and that strict compliance to its tenets is maintained.

A. Logistics Plans, Policy, and Strategic Mobility Division

The Director, Logistics Plans, Policy, and Strategic Mobility Division (LP), and more specifically the Logistics Policy and Capabilities Branch (LPC), executes the functions of the DoDAAC and Logistics Automated Information System manager of the Marine Corps. LPC is responsible for management of the Marine Corps' portion of the DoDAAD, to include:

1. Publishing policy for DoDAAC management and ensuring that USMC DoDAAC business rules are published within defense logistics management standards as necessary (i.e., assignment logic, MAJCOMs, etc.).
2. Serving as the Marine Corps' representative to the DLMS DoDAAD PRC.
3. Serving as the MAJCOM DoDAAC monitor to the Navy for Navy DoDAACs assigned to Marine Corps units under Navy MAJCOM "NB."
4. Serving as the Marine Corps liaison to DFAS and the DON FM&C for requesting BCNs from the Navy for DoDAACs that will be established as SRIs in the Marine Corps' financial accounting system, SABRS.
5. Serving as the Marine Corps liaison to DFAS and the DON FM&C for requesting Navy DoDAACs for United States Marine Corps (USMC) activities.
6. Coordinating with DC P&R (RFA) for the proper assignment of DoDAAC authority codes and for loading new DoDAACs to SABRS as necessary.
7. Reviewing and approving all DoDAAC requests (new, updates, or deletions) received at the CSP via NAVMC 11718.
8. Appointing CSP managers to perform the functions associated with DoDAAC management.

9. Ensuring that USMC DoDAAC data is accurately maintained and that periodic reporting of metrics is provided to HQMC, Defense Logistics Agency (DLA), and OSD as required.

10. Assigning/designating MAJCOM DoDAAC monitors.

11. Ensuring proper system integration for systems that utilize DoDAAC data.

12. Coordinating TFSMS updates with DC CD&I, and Global Combat Support System – Marine Corps (GCSS-MC) updates with Marine Corps System Command (MARCORSYSCOM), to ensure the accurate alignment of logistics data across the Marine Corps enterprise.

13. Receiving requirements for Navy DoDAACs (Service Designator Codes N, R, and V) from Marine Corps units and forwarding to the Navy CSP; also coordinating with Deputy Commandant, Aviation (DC AVN) Aviation Supply Logistics (ASL) and DC CD&I (TFSD) to review DoDAAC requirements for Marine Corps units with Navy personnel.

14. Coordinating with Commanding General, Training and Education Command (CG TECOM) to ensure that effective training programs are implemented in accordance with this policy.

15. Ensuring that Field Supply and Maintenance Analysis Office (FSMAO) Teams inspect for compliance with this policy and provide assistance as necessary.

**B. Contracts Division**

The Contracts Division (LB) is responsible for Marine Corps policy guidance on contracting and is also responsible for approving procurement authority for Marine Corps DoDAACs.

**C. DoDAAD Central Service Point**

Per reference [\(e\)](#) and reference [\(g\)](#), each service has a CSP which is responsible for ensuring the accuracy and currency of the DoDAACs assigned to that service. The CSP for the Marine Corps, located within DC I&L (LPC-2), is responsible for:

1. Monitoring and approving new DoDAAC assignments, changes, or terminations as outlined in this policy and as prescribed by reference [\(e\)](#) and reference [\(g\)](#).

2. Validating DoDAAC requests against adjacent databases (i.e., TFSMS, SABRS, GCSS-MC, MCTFS, etc.) prior to making changes to the DoDAAD.

3. Creating new DoDAACs using the Marine Corps' DoDAAC assignment logic rules.

4. Working with MAJCOM DoDAAC monitors to validate and process requested changes to DoDAACs.
5. Controlling the transmission of DoDAAC maintenance data to DLA TS.
6. Editing DoDAAC updates before they are processed into the DLA TS Web DoDAAD system.
7. Serving as the Navy's MAJCOM DoDAAC monitor for Navy MAJCOM NB.
8. The CSP for the Marine Corps may be contacted at:

Deputy Commandant, Installations and Logistics (LPC-2)  
Headquarters, U.S. Marine Corps  
3000 Marine Corps Pentagon (Room: 2E211)  
Washington, DC 20350  
Com: 571.256.7123 (DSN 260)  
Email: [USMCDoDAACMGR@usmc.mil](mailto:USMCDoDAACMGR@usmc.mil)

020503. Deputy Commandant, Programs and Resources

A. DC P&R is responsible for developing and defending Marine Corps financial requirements, policies, and programs. The P&R Department formulates the principles and policies that enable effective control and oversight of all Marine Corps financial operations to include budget execution, reporting on Marine Corps appropriations, and audit and review functions. DC P&R is the functional advocate for financial management systems (e.g., SABRS) and as such provides financial management policy input to DC I&L in support of logistics policy. Specific to DoDAAC management, DC P&R coordinates with DC I&L to ensure that DoDAACs are properly used within financial management systems (e.g., SABRS, PBDD, etc.).

B. RFA is responsible for ensuring that units and activities are loaded to SABRS, and for validating requisition and billing authority codes relative to Marine Corps DoDAACs and BPNs per reference [\(d\)](#).

020504. Deputy Commandant, Plans, Policies, & Operations

DC PP&O is responsible for establishing management controls over activities under his purview that are registered in the DoDAAD, and ensuring that they operate in compliance with this policy.

020505. Deputy Commandant, Combat Development and Integration (CD&I)

DC CD&I is responsible for the activities listed below.



A. Establishing management controls over activities under his purview that are registered in the DoDAAD, and ensure that they operate in compliance with this policy.

B. Prior to the activation of Marine Corps organizations, coordinating with DC I&L to ensure that capability exists within each organization necessary to provide for requirements fulfillment and/or accountability of resources.

C. Coordinating with DC I&L, DC PP&O, and the Marine Forces (MARFORs) for the timely update or retirement of TFSMS data for permanent and temporary organizations.

020506. Deputy Commandant, Aviation

Deputy Commandant, Aviation (DC AVN) is responsible for the activities listed below.

A. Establishing management controls over activities under his purview that are registered in the DoDAAD, and ensuring that they operate in compliance with this policy.

B. Aviation units requiring Navy DoDAACs shall submit their requirements to DC I&L (LPC-2), via DC AVN (ASL), who will contact the Navy DoDAAC CSP to establish Navy DoDAACs accordingly.

020507. Deputy Commandant, Manpower and Reserve Affairs

DC M&RA is responsible for the activities listed below.

A. Upon activation of a new unit, coordinating with DC I&L, DC P&R, and DC CD&I to ensure the proper assignment of unit identifiers required to enable system alignment (i.e., MCTFS) in accordance with this policy and reference [\(a\)](#).

B. Coordinating with the CSP at DC I&L (LPC-2) to ensure that proper mailing addresses are used for Type of Address Code (TAC) 1 fields for all DoDAACs.

020508. Director, Command, Control, Communications, and Computers

The Director, Command, Control, Communications, and Computers (C4) is responsible for the activities listed below.

A. Establishing management controls over activities under his purview that are registered in the DoDAAD and ensure that they operate in compliance with this policy.

B. Ensuring that as Department of the Navy, Deputy Chief Information Officer Marine Corps and all USMC systems that are part of the Marine Corps Information Environment and use DoDAAC authoritative data are aligned to the DoDAAD accordingly.

020509. Inspector General of the Marine Corps

The Inspector General of the Marine Corps' responsibilities include developing and implementing an inspection program to ensure compliance with this policy and the proper management of internal controls.

0206 COMMANDERS, MARINE CORPS FORCES

Marine Corps Force Commanders are responsible for the activities listed in the following sections.

020601. Establishing management controls over commands/activities under their purview that are registered in the DoDAAD, and ensure that they operate in compliance with this policy.

020602. Identifying MAJCOM DoDAAC monitors to DC I&L for the management of all DoDAACs that fall under the purview of each operating force MAJCOM.

020603. Coordinating all requests for new or updated DoDAACs with the CSP at DC I&L.

020604. Coordinating all requests for UIC assignments for task organized and provisional units with DC PP&O POR.

020605. Coordinating with MARCORLOGCOM to ensure the appropriate GCSS-MC source routing rules are properly established with the Business Rules Mapping 100 Form (BR-100) submission.

020606. Developing and implementing internal command policies and procedures to facilitate the execution of this policy.

0207 SUPPORTING ESTABLISHMENT

020701. Commanding General, Marine Corps Logistics Command

The Commanding General, MARCORLOGCOM is responsible for the activities listed below.

A. Establishing management controls over activities under his purview that are registered in the DoDAAD, and ensuring that they operate in compliance with this policy.

B. Identifying a MAJCOM DoDAAC monitor to DC I&L for the management of all DoDAACs that fall under the purview of MARCORLOGCOM (MAJCOM C5).

C. Serving as the MAJCOM DoDAAC monitor for all contractor DoDAACs to ensure that Government Furnished Property (GFP) equities are properly managed; in accordance with reference (h), ensuring that the Management Control Activity (MCA) facilitates all requirements for contractor-related DoDAACs.

D. Maintaining close coordination with MARCORSYSCOM Program Executive Officer Enterprise Information Systems (EIS) GCSS-MC Program Office; DC I&L; and DC CD&I, to ensure accurate alignment of logistics data in GCSS-MC (e.g., UIC/DoDAAC associations).

020702. Commanding General, Training and Education Command

CG TECOM is responsible for the activities listed below.

A. Establishing management controls over activities under his purview that are registered in the DoDAAD and ensuring that they operate in compliance with this policy.

B. Ensuring that training programs support the guidance contained within this policy.

C. Identifying a MAJCOM DoDAAC monitor to DC I&L for the management of all DoDAACs that fall under the purview of TECOM (MAJCOM C4).

020703. Commander, Marine Corps Systems Command

The Commander, MARCORSYSCOM is responsible for the activities listed below.

A. Establishing management controls over activities under his purview that are registered in the DoDAAD and ensuring that they operate in compliance with this policy.

B. In coordination with DC I&L, ensuring that the provisions of this policy support Total Life Cycle Management of programs and equipment.

C. Identifying a MAJCOM DoDAAC monitor to DC I&L for the management of all DoDAACs that fall under the purview of MARCORSYSCOM (MAJCOM C6).

D. Coordinating with the MARCORLOGCOM MCA for the establishment of contractor DoDAACs supporting Marine Corps systems.

E. Coordinating logistics data integration with DC CD&I, DC I&L, and CG MARCORLOGCOM to ensure that proper data associations (e.g., UIC/DoDAAC/ Equipment Denisty List (EDL)/GCSS-MC Source Routing Rules) are displayed within GCSS-MC.

020704. Commander, Marine Corps Installations Command

The Commander, Marine Corps Installations Command (MCICOM) is responsible for the activities listed below.

A. Establishing management controls over commands/activities under his purview that are registered in the DoDAAD, and ensuring that they operate in compliance with this policy.

B. Identifying MAJCOM DoDAAC monitors to DC I&L for the management of all DoDAACs that fall under the purview of MCICOM (MAJCOM C2) and each Supporting Establishment MAJCOM.

C. Developing and implementing internal command policies and procedures to facilitate the execution of this Order.

#### 0208 INDIVIDUAL COMMANDS AND ACTIVITIES

Every command and activity that has a DoDAAC is responsible for ensuring that the information within the DoDAAC is maintained accurately in order to minimize disruption to logistics and financial systems. All Marine Corps commands and activities will submit requests to update their DoDAACs to the CSP via their MAJCOM DoDAAC monitor.

#### 0209 MAJOR COMMAND DODAAC MONITORS

For the purposes of DoDAAC management, the term “MAJCOM” has a dual meaning: the MAJCOM codes themselves and the commands those codes represent. Per reference [\(g\)](#), every DoDAAC has a two-digit code called a MAJCOM. This code designates the MAJCOM to which the unit possessing the DoDAAC belongs. There are currently 27 active MAJCOMs in the Marine Corps, each with a unique MAJCOM code (see Appendix C). By this structure, DoDAAD hierarchy is established within the Marine Corps.

020901. Each MAJCOM will appoint a primary and an alternate MAJCOM DoDAAC monitor through whom all requests are routed. Any changes in point of contact (POC) information, office symbol, and/or telephone number should be forwarded on an as-occurring basis to the CSP at DC I&L. In the event both MAJCOM DoDAAC monitors are unavailable for an extended period, the command will either appoint a new primary MAJCOM DoDAAC monitor or contact the CSP for assistance.

020902. Each MAJCOM DoDAAC monitor in the Marine Corps is responsible for managing the DoDAACs belonging to his or her MAJCOM as designated in the DoDAAD.

020903. The MAJCOM DoDAAC monitor receives, reviews, and approves/disapproves DoDAAC requests (additions, changes, and deletions) initiated by a unit within his or her MAJCOM or by the MAJCOM itself. The MAJCOM DoDAAC monitor shall review requests to ensure the information contained in the request is valid, is aligned to the proper authority, and is associated to the proper UIC per the information provided in this policy, and to ensure that the DoDAAC is properly enabling the intended business process for which it is being requested or updated. This function is also the focal point for the annual validation of all DoDAAC accounts within the command.

020904. MAJCOM Monitors for Contractor DoDAACs

Contractor DoDAACs are obtained primarily to enable the contractual arrangement between the government and the private sector for processes related to GFP or Contractor Acquired Materiel (CAM). Reference (h) tasks the MCAs at MARCORLOGCOM and MARCORSYSCOM with the responsibility of managing GFP/CAM on behalf of the Marine Corps. Accordingly, the MCAs shall serve as the MAJCOM DoDAAC monitor for all contractor DoDAACs. Consequently, all requests for contractor DoDAACs will be routed through the MCAs for screening and approval prior to final approval and action by DC I&L and the CSP.

0210 MARINE CORPS CONTRACTING OFFICERS

While the MCA is responsible for managing GFP/CAM, the responsibility for managing contractor DoDAACs lies with the Contract Administration Officer or Defense Contract Management Agency (DCMA) Office that has administrative oversight of the contract. Sponsors of contractors who have Marine Corps DoDAACs are responsible for the accuracy of the data contained in the contractor's DoDAAC. All requests for contractor DoDAACs shall be forwarded to the CSP via the MAJCOM DoDAAC monitor. Specifically, contracting officers who have administrative oversight of contracts for which DoDAACs are assigned and are responsible for:

- 021001. Ensuring that the DoDAAC assigned by the CSP is included in the contract.
- 021002. Ensuring that the contract delineates how that DoDAAC is to be used (shipping, requisitioning, etc.).
- 021003. Ensuring that the contract stipulates how the GFP/CAM will be returned to the government prior to termination of the contract's term, since the DoDAAC is deleted upon expiration of the contract.
- 021004. Submitting new DoDAAC requests for contractors, and ensuring that all data contained in the request is accurate.
- 021005. Initiating contractor DoDAAC change requests to include extensions of contract expiration dates. Contractor DoDAACs will automatically be deleted based on the expiration date of the contract.
- 021006. Monitoring contractor DoDAACs for contracts they have initiated to ensure any necessary modifications or extensions are submitted prior to a contract expiring.

**VOLUME 2: CHAPTER 3**

**“DEPARTMENT OF DEFENSE ACTIVITY ADDRESS CODE ESTABLISHMENT”**

**SUMMARY OF SUBSTANTIVE CHANGES**

Hyperlinks are denoted by ***bold, italic, blue and underlined font.***

The original publication date of this Marine Corps Order (MCO) Volume (right header) will not change unless/until a full revision of the MCO has been conducted.

All Volume changes denoted in **blue font** will reset to black font upon a full revision of this Volume.

<b>CHAPTER VERSION</b>	<b>PAGE PARAGRAPH</b>	<b>SUMMARY OF SUBSTANTIVE CHANGES</b>	<b>DATE OF CHANGE</b>

**CHAPTER 3**

**DEPARTMENT OF DEFENSE ACTIVITY ADDRESS CODE ESTABLISHMENT**

0301 UNITED STATES NAVY

030101. Systems

The Navy's UICs and DoDAACs are the same as the Marine Corps'; however, unlike the Marine Corps, the Navy maintains three distinct databases for UICs in addition to their stewardship of Navy DoDAACs in the DoDAAD. Any command/activity that is performing a Marine Corps business process tied to a Navy system must be registered in the Navy's systems as a Navy UIC and, as necessary, a Navy DoDAAC.

A. Navy UIC List

The Navy's UIC list contains all five-digit UICs for Navy commands and shore activities that require registration and identity in Navy systems, especially financial management and accounting systems. The Navy's UIC list is maintained by DFAS as the executive agent of the DON FM&C Office.

B. Standard Naval Distribution List

The Standard Naval Distribution List is the official listing of all established commands and detachments of the U.S. Navy (including homeport and permanent duty station assignments for fleet units). It is maintained and published by Director, Navy Staff, Director of Management, Organization and Management Branch (DNS-33) on behalf of the Secretary of the Navy and Chief of Naval Operations. It may be accessed at <http://doni.documentservices.dla.mil>.

C. Total Force Manpower Management System

The Navy's Total Force Manpower Management System (TFMMS) is the Navy's ADS for total force manpower requirements, active-duty manpower personnel, Navy/Reserve personnel, Navy manpower authorizations, and end strength. TFMMS supplies information to other civilian and military personnel accounting and distribution systems to assist them in their total force management functions. TFMMS's approach is to track and display Navy manpower requirements through the use of unique Billet Identification Numbers.

030102. Navy DoDAACs

Three general categories of DoDAACs applicable to Marine Corps activities with Navy DoDAACs are published in reference (e), "Department of Defense Activity Address Directory": "N", "R", and "V" prefixed codes identify Marine activities which must have a Navy identifier for Navy systems/business processes. While the requirements to maintain Navy DoDAACs are the same as for maintaining Marine Corps DoDAACs, the process is slightly different. See Chapter 4 of this Volume.

0302 UNITED STATES MARINE CORPS

Two general categories of DoDAACs applicable to the Marine Corps are published in reference (e): "M" prefixed codes, identifying Marine Corps units; and "L" prefixed codes, identifying contractors with which the Marine Corps conducts business. The maintenance of current and accurate DoDAAC information is a command responsibility.

030201. Requirements

There are four primary criteria for creating a Marine Corps DoDAAC: authority, UIC, mission, and capability.

A. Authority

Every DoDAAC must be assigned to a commander who has overall responsibility for that DoDAAC and how it is used. It is the commander's authority that directs the DoDAAC to be used for supply/fiscal and accounting business processes for which it is established. Applicable business processes that may be enabled or restricted for certain DoDAACs include the authority to requisition material (thereby obligating government funds), to be used as a shipping (Ship To) destination, to be used for billing, and to be used to account for government property and material within an Accountable Property System of Record (APSR).

1. The NAVMC 11718 identifies this assignment and the commander's validation that the command has adequate personnel structure (i.e., supply/fiscal officer, accountable property officer (APO), supply chief, supply/fiscal clerks, warehousemen) to perform the supply/fiscal accounting business processes enabled by the DoDAAC.

2. HQMC DC I&L approves two-digit authority codes which are used to restrict requisitioning, shipment, and billing by DoDAAC. Authority codes identify the capabilities and limitations that are associated with a particular DoDAAC and are used to prevent unauthorized requisitioning and billing by activities that do not have the authority or that lack the capability to manage applicable transactions within logistics and financial systems. See Appendix D for more information on authority codes.

3. When a unit's assigned Table of Organization (T/O) does not include adequate supply management personnel to perform the command's supply/fiscal accounting business processes, the unit is assigned a Ship-To-Only DoDAAC. This designates that the unit/activity is authorized to receive shipments, but cannot requisition or pay bills. It also implies that the activity has the requisite capability in trained personnel to do proper receipt and acceptance of materials received. In this case, a supporting activity will be identified to fulfill supply management functions (e.g., requisition management, funds obligations and expenditures) on behalf of the supported activity/unit.

4. Separately, if the supported activity requires its own DoDAAC but possesses no supply management personnel, a supporting activity will be assigned an additional DoDAAC in order to provide the applicable supply support to the supported activity. In this situation, the supporting activity shall be accountable for the DoDAAC of the supported activity. In



either case, the NAVMC 11718 shall include a certification that supply/fiscal accounting personnel are in place or that supply/fiscal management functions will be performed by a supporting activity on behalf of the requesting activity.

B. UIC

Every DoDAAC shall be associated to a UIC. The specific DoDAAC/UIC association depends on the type of unit/activity.

1. Permanent Activity. If the DoDAAC is required for a standing unit/activity that is represented by a UIC in TFSMS, the TFSMS UIC shall be used. Marine Corps Bulletin (MCBUL) 5400s establish permanent units in the Marine Corps and assign UICs.

2. Task-organized Activity. See chapter 5 in this Volume on task organizations.

3. UICs for Contractor DoDAACs. The UIC used for contractor DoDAACs shall be the UIC of the sponsoring command (e.g., contractor DoDAAC L00001 associated to UIC M38001 for MARCORLOGCOM, and DoDAAC L00002 associated to UIC M37101 for MARCORSYSCOM).

C. Mission

The newly created unit/activity must have a mission requirement that includes one or more of the following responsibilities: to requisition, ship, receive, fund/pay bills, and/or account for supplies, materiel, equipment, services, and any other requirement under policy and procedures issued by CMC and higher headquarters.

D. Capability

In order to perform supply/fiscal management functions in support of the unit mission, the unit/activity must have the requisite capability in trained supply management personnel (i.e., supply/fiscal officer, APO, and staff). Since most supply sections are assigned by T/O at the battalion level, units below the battalion/separate company level will not normally have DoDAACs assigned unless specified by HQMC. It is the responsibility of the activity commander to ensure that a property and/or financial accounting capability are provided as necessary to accomplish the mission of the unit/activity. Units that do not have the supply/fiscal accounting personnel capability will require the assistance of a supporting activity/unit tasked to provide the required support.

030203. DoDAAC Assignment Logic

DoDAACs are created by the CSP at DC I&L according to a specific assignment methodology to ensure consistency and proper alignment to other identifiers. The CSP is responsible for creating DoDAACs using published assignment logic rules. To facilitate this, the internal assignment logic in Appendix E is used for creating DoDAACs. This information is kept on file by DLA TS and is published by DLMSO within DoD policy as the Marine Corps' business rules for DoDAAC assignment logic. HQMC is responsible for developing, maintaining, and providing this information to DLMS on an as-occurring basis. DoDAACs may be based on MILSTRIP RICs (e.g., MMR100 identifies the General Account of the Supply Management Unit (SMU), 3d Supply Battalion, 3d MLG (RIC MR1)). Assigned DoDAACs will be unique and will not duplicate existing DoDAACs published in the DoDAAD.

030204. "M"-Prefixed DoDAACs

"M"-prefixed DoDAACs are assigned for Marine Corps units as follows:

A. Sub-allotment Recipient Identifier (SRI)-Level Units

In the initial construction of the six-digit DoDAAC prescribed by reference (e), if the activity has an existing financial UIC assigned by DFAS, the DoDAAC will be created by adding an "M" prefix to the five-digit UIC. DC P&R is responsible for creating financial accounting records in USMC financial management systems (i.e., SABRS).

1. When the requirement for a new DoDAAC arises that could potentially require inclusion in the DON UIC table, in order to ensure system alignment, DFAS shall be contacted to obtain a financial UIC which will then be used to create the new DoDAAC. DC I&L requests financial UICs from the DON FM&C via DFAS.

2. These financial UICs are then used to create the "M" DoDAAC for use in SABRS (when it is O&M, MC appropriations) and "N", "R", or "V" DoDAACs for Navy Systems (when it is O&M, N appropriations).

B. Work Center Identifier/Battalion-level Units

When a unit is created below the BCN/SRI level (i.e., at the battalion level), if the unit has an existing TFSMS UIC, the CSP shall use that UIC to create the DoDAAC. If, however, no financial or TFSMS UIC exists, the CSP shall unilaterally create a new DoDAAC from the DoDAAD according to the CSP's DoDAAC Assignment Logic for creating unique DoDAACs. WCIs are usually a M4XXXX series DoDAAC.

C. Requisitioning DoDAACs

DoDAACs of all units authorized to requisition against funds allotted to the command will be loaded to SABRS Table 208. Failure to incorporate all DoDAACs authorized to charge funds under the applicable MRI/ARI/SRI/WCI/AAC will result in rejected requisitions. See also Appendix A.

D. Non-Appropriated Fund (NAF) DoDAACs

DoDAACs for business processes which utilize Non-Appropriated Funds (NAF) are not listed in SABRS Table 208; however, they still require authority code 00. These DoDAACs are listed in, and governed as per reference [\(j\)](#).

030205. L-Prefixed DoDAACs

Since each service component's CSP assigns DoDAACs independent of one another for contractors supporting their service component, a commercial activity may be identified by different DoDAACs assigned by each of the services. Furthermore, since DoDAACs for contractors are specific to a particular address, and since contractors can have multiple addresses necessary for the facilitation of various contracts, a single contractor may have multiple DoDAACs for a given service. These L-prefixed DoDAACs are assigned for contractors supporting the Marine Corps on existing contracts and must include all mandatory contractor information required by the contractor fields of the DoDAAC (see chapter 4 of this Volume). Contractor DoDAACs are not loaded to USMC financial management systems.

030206. All the data elements contained in the DoDAAC, and outlined on NAVMC Form 11718, shall be included when requesting a DoDAAC from the CSP (see Appendix F).

030207. Once loaded, DoDAACs will not be changed or deleted, except by specific request of the command concerned.

**VOLUME 2: CHAPTER 4**

**DEPARTMENT OF DEFENSE ACTIVITY ADDRESS CODE MANAGEMENT”**

**SUMMARY OF SUBSTANTIVE CHANGES**

Hyperlinks are denoted by ***bold, italic, blue and underlined font.***

The original publication date of this Marine Corps Order (MCO) Volume (right header) will not change unless/until a full revision of the MCO has been conducted.

All Volume changes denoted in **blue font** will reset to black font upon a full revision of this Volume.

<b>CHAPTER VERSION</b>	<b>PAGE PARAGRAPH</b>	<b>SUMMARY OF SUBSTANTIVE CHANGES</b>	<b>DATE OF CHANGE</b>

CHAPTER 4

DEPARTMENT OF DEFENSE ACTIVITY ADDRESS CODE MANAGEMENT

0401 THE DODAAC MANAGEMENT PROCESS

While situations vary for requesting the creation, update, or deletion of DoDAACs, the basic process remains largely the same. Figure 4-1 identifies the process flow for routing of information to request, update, or delete DoDAACs from the DoDAAD.

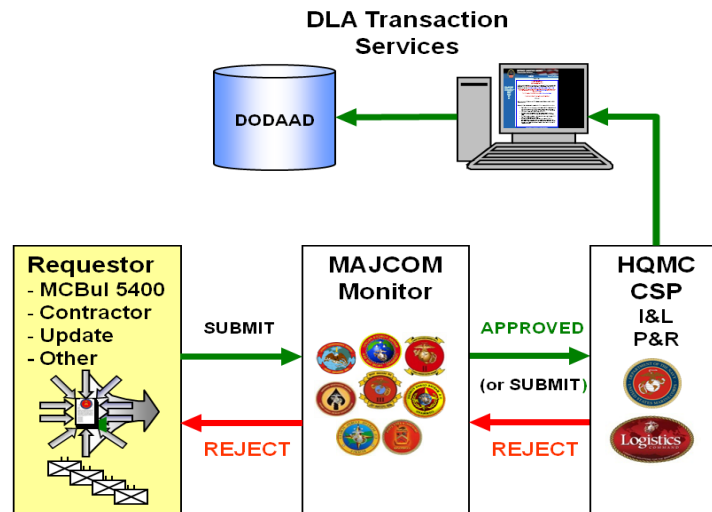

Figure 4-1. DoDAAC Management Process

0402 ROLE-BASED PROCESS

While currently not enabled by information technology, the DoDAAC management process is role-based, as depicted in Figure 4-2. There are core functions that largely apply to anyone. These include the ability to search, view, and request a DoDAAC. This may be done via DLA TS at <https://www.transactionservices.dla.mil/DAASINQ/default.asp>. Only authorized requestors within a MAJCOM may request changes, updates, or deletions to existing DoDAACs.

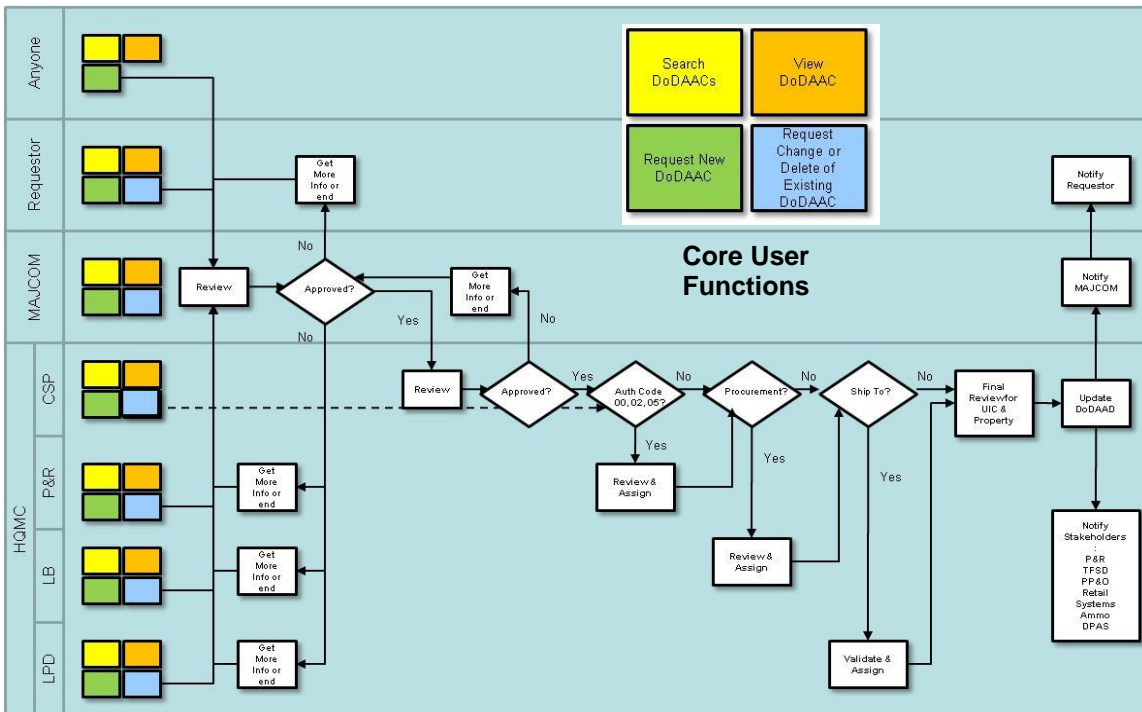

Figure 4-2. Detailed Workflow Process

#### 0403 DODAAC REQUESTS

All DoDAAC requests are facilitated by a completed and approved NAVMC 11718 DoDAAC Request Form. Requests are generated by either an existing DoDAAC-holder or potential requestor and are forwarded to the MAJCOM monitor for validation and approval. The request is then forwarded to HQMC for action. If the request requires further validation/approval, it will be forwarded to other stakeholders across HQMC for review before arriving at the CSP for appropriate action. If the request is approved, the CSP manager then creates, updates, or deletes the DoDAAC via the DoDAAD update application of DLA TS and notifies the MAJCOM and requestor once action has been completed. Completed NAVMC 11718s will then be archived electronically by the CSP manager at DC I&L (LPC-2).

#### 0404 TYPES OF REQUESTS

There are four types of DoDAAC requests: new, change, delete, and unit rotations. While detailed instructions for each are included in the NAVMC 11718, the following additional guidance is provided:

##### 040401. Request for a New DoDAAC

Every DoDAAC is tied to the authority of the commander to whom it is assigned, and each is given an authority code as necessary to perform the business processes for which the DoDAAC is being requested to enable. There are several situations for which the creation of a new DoDAAC may be required:

**A. Marine Corps Bulletin 5400**

Per as per reference (a), whenever a new unit is activated, DC CD&I publishes guidance concerning how the new permanent unit shall be established. This guidance is provided via a MCBul 5400 which details all of the requisite instructions (i.e., unit name, unit identifiers, readiness reporting instructions, etc.) for every stakeholder in order to facilitate the activation of the new organization. For the creation of a DoDAAC, the process outlined in chapter 3 of this Volume applies to ensure that proper system alignment for the unit identifiers is accomplished. The MCBul 5400 and NAVMC 11718 shall be forwarded to the CSP, via the corresponding MAJCOM monitor, to create the new DoDAAC.

**B. Contractors**

When the Marine Corps requires support from a contractor that requires them to perform any of the business processes outlined in chapter 3 of this Volume, the Marine Corps contracting officer creating the contract will request a DoDAAC through the MCA at MARCORLOGCOM who acts as the MAJCOM monitor for all contractors doing business with the Marine Corps. The contracting officer shall ensure that the NAVMC 11718 is prepared with all pertinent information as required by chapter 3 and appendix F of this policy. Note: Contractor DoDAACs are set to automatically delete on the expiration date of the contract. Figure 4-3 details the process for requesting contractor DoDAACs.

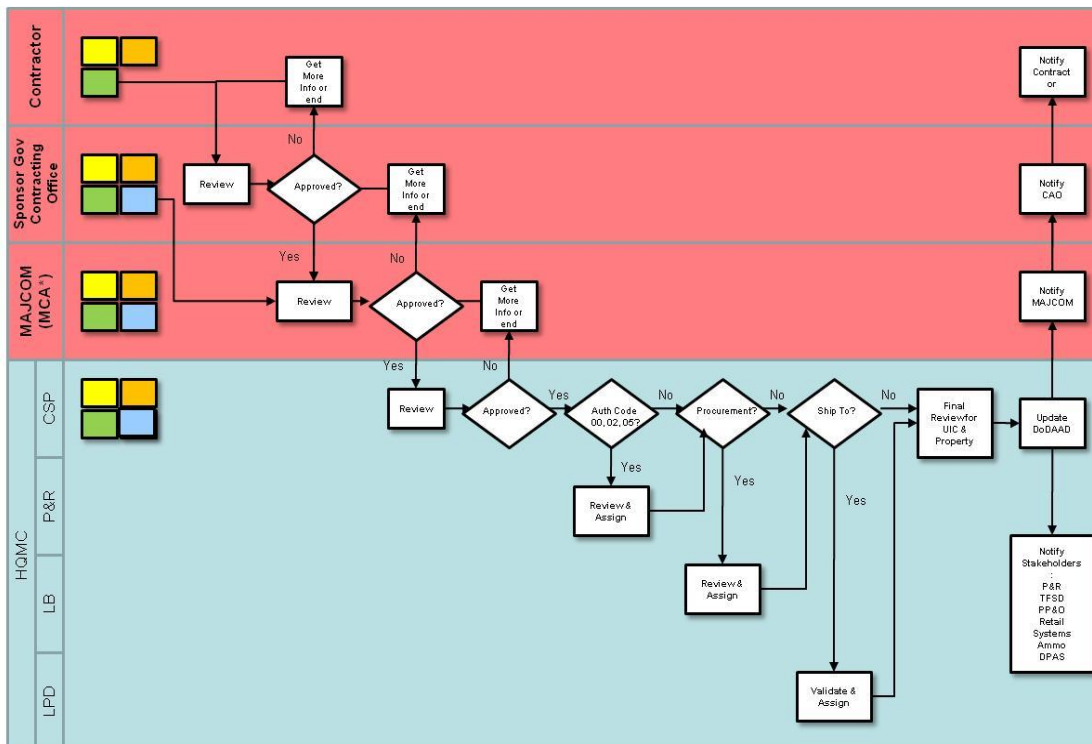

\*The MCA is the Management Control Activity (MarCorLogCom) who is responsible for managing Government Furnished Property (GFP) and Contractor Acquired Material (CAM).

**Figure 4-3. Detailed Workflow Process for Contractor DoDAACs**

C. Contingency, Exercise, and Other Accounts

Whenever there is a requirement to enable requisitioning, shipping, receiving, funding/paying bills, and/or accounting for resources for a readiness reportable unit in DRRS-MC, a DoDAAC is required. Permanent units reporting readiness in DRRS-MC will use the TFSMS UIC. Whether the DoDAAC is required in support of an exercise or real world contingency, there is a planning process that considers all of the factors necessary to enable the unit to carry out its core or assigned mission. The DoDAAC is just one of these planning factors. See Chapter 5 in this Volume on unit deployments.

040402. Request to Change a DoDAAC

All Marine Corps activities are responsible for ensuring that the data contained within their DoDAAC is maintained accurate on an as-occurring basis. Whenever it becomes necessary to change the information contained in a DoDAAC (i.e., change to mailing address, deployments, etc.), a DoDAAC change request shall be forwarded to the CSP via the MAJCOM monitor. All of the data elements contained in the NAVMC 11718 shall be completed as part of the request (see Appendix F). For task organization, refer to chapter 5 in this Volume.

040403. Request to Delete a DoDAAC

Whenever it becomes necessary to delete a DoDAAC, a NAVMC 11718 shall be forwarded to the CSP via the MAJCOM monitor. When a DoDAAC is deleted, it remains listed in the DoDAAD for five years past the deletion date before being purged by DLA TS.

A. Marine Corps Bulletin 5400

Per as per reference [\(a\)](#), when a unit is to be deactivated, DC CD&I publishes guidance for executing the deactivation. This guidance is provided via a MCBul 5400 which details all requisite instructions for every stakeholder. The MAJCOM monitor shall forward the NAVMC 11718 request to delete the DoDAAC, along with the corresponding MCBul 5400, to the CSP. The CSP manager at DC I&L will then delete the DoDAAC and forward the information to the requisite business process owners (i.e., SASSY, GCSS-MC, SABRS, etc.). This action, however, shall be conducted only after supply and financial system records for the DoDAAC have been properly closed out by the unit/MAJCOM.

B. Contractors

When a contract reaches its expiration date without being renewed, the DoDAAC created for that contract will automatically be deleted. For contractor DoDAACs that were not set to automatically expire, the CSP manager shall periodically review the DoDAAD and delete any contractor DoDAACs whose contract expiration dates have passed. If a contractor's RIC is tied to a series of National Stock Number (NSNs) for direct procurement, the contracted logistics support RIC becomes obsolete and a logistics reassignment to Management and Productivity Branch (MPB) at DC P&R transferring procurement and support responsibility needs to be accomplished prior to the deletion of the DoDAAC and its associated RIC.



C. Other Accounts

When a DoDAAC was created to enable a particular business process, and that business process has been completed (i.e., end of a deployment or exercise), the MAJCOM monitor shall forward the NAVMC 11718 request to delete the DoDAAC to the CSP. The CSP manager will then delete the DoDAAC and forward the information to the requisite business process owners (i.e., SASSY, GCSS-MC, SABRS, etc.). NOTE: This action shall be conducted only **after** all system records for the DoDAAC have been properly closed out by the unit/MAJCOM.

D. DoDAAC Deletion

Commands shall not initiate DoDAAC deletion action until all outstanding requisitions (supply and fiscal actions) using that DoDAAC have been completed or canceled (including cancellation confirmation). A request for deletion of a DoDAAC will not be approved unless the command includes the statement "All outstanding requisitions for this DoDAAC have been canceled/completed." The MAJCOM is responsible for archiving accountable records for ten years (3 years active and 7 years archived).

E. Marine Corps activities that have been assigned Navy DoDAACs shall utilize DFAS Form 9025 to make changes to their Navy DoDAACs. The same workflow process shall be followed for processing these forms (i.e., unit to MAJCOM to HQMC CSP); however, approval signatures are not required on this form. Instructions for completing this form are contained in Appendix G. For any business process that uses Navy systems, a Navy DoDAAC is required, and if the process also involves Navy funding (O&M N), a Navy UIC must first be obtained (see chapter 3 in this Volume). DFAS is the CSP for Navy DoDAACs, and the Marine Corps CSP is the MAJCOM DoDAAC monitor to the Navy for Navy MAJCOM NB.

0405 DODAAC VALIDATION AND MAINTENANCE

The maintenance of current and accurate address information in the DoDAAD is a command responsibility. All Marine Corps units/activities shall ensure that their DoDAAC information is maintained current within the DoDAAD, in accordance with as per reference [\(e\)](#) and this policy.

040501. Annual Validation

In order to ensure that DoDAAC/RIC data is being properly maintained, DC I&L will task every MAJCOM DoDAAC monitor to validate Marine Corps DoDAACs and RICs on an annual basis. This annual validation will occur during the second quarter of each fiscal year. Commanders will review the data provided by DC I&L and submit corrections according to the instructions provided herein.

040502. Proper Maintenance

Commanders must pay particular attention to the assignment of DoDAACs with requisition authority (authority code 00) and ensure that DoDAACs assigned this authority code meet the definition contained in this policy. In order to maintain the DoDAAD's accuracy, all Marine Corps activities shall review and validate DoDAACs/RICs on a continuing basis and ensure that all address information is accurate and current. If required, take timely action to add, revise, or delete DoDAAC/RIC data per the policies outlined herein. Requests for changes shall be forwarded via NAVMC 11718 as outlined in chapters 4 and 5 in this Volume.

0406 DODAACS AND ORGANIZATIONAL CHANGE MANAGEMENT

Reference (a) defines the Total Force Structure Process. This policy explains how the Marine Corps orchestrates organizational change. Once all of the planning factors are established for activating, deactivating, reorganizing, or relocating an existing organization, it is codified into a directive that lays out all the steps to be taken by all stakeholders across the Marine Corps to enable the organizational change. This directive is the MCBul 5400. Since DoDAACs are used to enable the business processes of an organization, it is critical that all equities are properly identified during the planning process for the following organizational changes.

040601. Unit Activations

In order to be assigned the appropriate DoDAAC, newly activated organizations must have the mission, authority, and capability to perform all of the business processes envisioned for the activity. If an organization lacks the proper capability for accountability of resources for which the DoDAAC is required, it shall be supported by another activity either through its own DoDAAC or through an additional DoDAAC managed by the supporting activity on behalf of the supported activity. In either case, all supported and supporting relationships will be identified within MCBul 5400 in order to ensure the proper accountability of resources (i.e., property, materiel, services, funds, etc.).

040602. Unit Deactivations

Whenever an organization is scheduled to be deactivated, a MCBul 5400 will identify the actions required to ensure the proper close out of all systems using the DoDAAC for the activity. All close out actions must be accomplished prior to deleting the DoDAAC.

040603. Unit Reorganizations/Relocations

Any unit reorganizations or relocations that impact a unit's DoDAAC must be reflected in the DoDAAC's official information via the NAVMC 11718. This ensures that the DoDAAD reflects the current state of the organization.

**VOLUME 2: CHAPTER 5**

**“UNIT DEPLOYMENTS”**

**SUMMARY OF SUBSTANTIVE CHANGES**

Hyperlinks are denoted by *bold, italic, blue and underlined font*.

The original publication date of this Marine Corps Order (MCO) Volume (right header) will not change unless/until a full revision of the MCO has been conducted.

All volume changes denoted in blue font will reset to black font upon a full revision of this Volume.

<b>CHAPTER VERSION</b>	<b>PAGE PARAGRAPH</b>	<b>SUMMARY OF SUBSTANTIVE CHANGES</b>	<b>DATE OF CHANGE</b>

**CHAPTER 5**

**UNIT DEPLOYMENTS**

**0501 ORIGINATION**

If it is determined that a DoDAAC is required to enable certain business operations during unit deployments, the MAJCOM will direct the submission of a DoDAAC Request (NAVMC 11718) and forward it to the CSP at DC I&L on behalf of the unit(s) affected by the deployment. For example, if a repair parts block must be forward-deployed to enable a maintenance detachment to perform field-level maintenance, a DoDAAC will be required to enable ship-to and requisition capability for that parts block. The DoDAAC will be used to create the account within the requisite systems to create the block. In any case, the unit requiring the DoDAAC shall forward the DoDAAC request to the CSP, via the corresponding MAJCOM monitor.

**0502 PLANNING FACTORS**

The same planning factors considered during the planning process for new unit activations apply for the establishment of task organized units and provisional units. Key logistics planning factors include how the organization will conduct property accountability and control, readiness reporting, requisitioning, shipping, and billing. The identity of the unit within logistics and financial systems needs to be properly registered to ensure the successful execution of logistics business processes whether the deployment is a unit rotation in support of an enduring requirement, or the stand-up of a provisional unit. It is critical that all relevant system owners be properly notified by the initiator of the deployment (i.e., DC PP&O, MARFOR, MEF) to ensure that all authoritative systems are updated with required changes. A DoDAAC Request (NAVMC 11718) is necessary to change an existing DoDAAC or to create a new DoDAAC. Whatever the type of deployment, the alignment of the organizational UIC to the correct DoDAAC is the key event from which all subsequent system changes cascade ensuring uninterrupted business processes for logistics operations, financial management, and equipment reporting.

**0503 TERMS**

**050301. Task Organized Unit**

A temporary grouping of forces designed to accomplish a particular mission. These organizations are generally formed using a designated unit as the core element with augmentation of temporary reassigned personnel and equipment from other organizations based on the requirements to accomplish its assigned mission. The core unit's TO&E, resident in TFSMS and identified by a UIC, serves as the baseline for logistics planning (e.g., personnel and equipment sourcing). If the unit's assigned mission equipment requirements are different from their core Table of Equipment (T/E) captured in TFSMS, the unit will use an approved equipment density list (EDL) to capture the equipment requirements.

050302. Provisional Unit

A service or combatant commander-(COCOM) directed temporary assembly of personnel and equipment organized for a limited period of time for accomplishment of a specific mission. Provisional units that are required to report readiness are identified by PP&O-provided UICs. Examples are a SPMAGTF or a named organization approved by HQMC. Provisional Units can be registered in TFSMS using the PP&O-provided UIC along with the HQMC approved EDL.

0504 DODAAC/UIC DATA ALIGNMENT

050401. All Marine Corps approved APSRs will have appropriate DoDAAC/UIC alignment established to account for equipment and materiel at the DoDAAC level. UICs will not be used for accountability of equipment whether the unit is core or provisional. Within Marine Corps APSRs, DoDAACs are used to identify equipment sets that fill the T/E requirements of a unit. As such, every DoDAAC will be associated to a unit's UIC. The specific DoDAAC/UIC association depends on the type of unit/activity. For example, if the DoDAAC is required for a permanent unit represented by a UIC in TFSMS, the DoDAAC will be associated to the UIC. A DoDAAC required for a provisional unit will be associated to the PP&O POR UIC assigned to the unit. The relationship between a UIC and DoDAAC is one of "requirements" to "resources." Within TFSMS, a DoDAAC is used to identify the property account ID that satisfies the requirements represented by the T/E of a UIC.

050402. Maintaining the relationship between UIC and property account ID (DoDAAC) within TFSMS is the product of the DoDAAC update process. This relationship principally identifies the unit's core mission equipment requirements and the property account (DoDAAC) that satisfies these requirements. A unit's core mission structure is the TO&E resident in TFSMS. The DoDAAD is the ADS for the relationship between UICs and DoDAACs. Per this guidance, all other systems shall consume this data directly from DoDAAF to ensure data integrity across the Marine Corps enterprise. Procedures for establishing DoDAAC/UIC alignment in support of equipment accountability and reporting are provided below.

0505 TYPES OF DEPLOYMENTS

For the purposes of DoDAAC management, there are generally four types of deployment scenarios: training exercises, contingencies, unit rotations, and deployments afloat. Whenever a DoDAAC is required to account for equipment requirements in support of a task organization or a unit executing an assigned mission different from their wartime (core) mission, the unit will either maintain the same DoDAAC, request an exercise DoDAAC, or request a contingency DoDAAC via their appropriate chain of command (Major Subordinate Command (MSC) or MEF DoDAAC Monitor).

050501. Training Exercises

An infantry battalion may provide a company for a local training exercise. In this example, the company is not detached from its parent battalion as it is performing training at a temporary location. The DoDAAC assigned to the unit will not change.

A. Task-Organized Exercise

A task-organized exercise involves the creation of an exercise DoDAAC to facilitate a newly-formed task-organized unit conducting an exercise. An exercise DoDAAC is created using assignment logic of “MM\_\_\_\_” series DoDAACs already established for the applicable MEF (See Appendix E). The third digit of the DoDAAC will be an alpha character. Exercise DoDAACs will be associated to the assigned TFSMS UIC of the unit. The NAVMC 11718 will be used to request the DoDAAC in accordance with this policy.

B. Unit Provides a Detachment in Support of a Task-Organized Exercise

When a unit provides a detachment of personnel and/or equipment for a task-organized exercise, the detachment is no longer under the tactical control (TACON) of their parent organization. For example, a battalion detaching a company of personnel and/or equipment to another unit for a training exercise at a deployed location would assign the company as TACON to the unit gaining the resources. Align the exercise DoDAAC to the UIC of the unit that gained the personnel and equipment.

C. Unit Conducts Training in Support of a Task-Organized Exercise

When a unit is conducting training and has personnel and/or equipment temporarily located away from the location of the unit, these resources still belong to the parent unit. For example, when a battalion provides a company for a training exercise at an alternate location from the unit, the unit continues to report on the resources even though they may be geographically separated. Align the exercise DoDAAC to the UIC of the parent unit.

050502. Contingencies

A contingency involves the creation of a contingency DoDAAC to facilitate a task-organized or provisional unit conducting an assigned mission within a theater under the jurisdictional control of one of the unified commands or in support of a national command authority. In these instances, create a contingency DoDAAC using the assignment logic of “MX\_\_\_\_” series DoDAACs (See Appendix E). Align the contingency DoDAAC to the appropriate TFSMS or PP&O POR UIC (e.g., M99XXX). For example, SPMAGTF-12 CE (PP&O POR UIC M99999) receives attachments from other reporting units. In this instance, align the DoDAAC to the PP&O POR UIC M99999.

A. Units providing detachments to the task-organized or provisional unit will be assigned the contingency DoDAAC. The DoDAAC will be associated with the PP&O POR UIC.

B. For units executing an assigned mission, other than their wartime (core) mission, (e.g., an infantry battalion performing the assigned mission of Marine Expeditionary Unit (MEU) Battalion Landing Team or SPMAGTF), the DoDAAC will not change and the unit will use the same TFSMS UIC.

C. Supply activities attached to task organized and/or provisional units involved in an overseas contingency operation and geographically separated from their retail level supply support activity will:

1. Route all supply requisitions directly to the “in-theater” supporting Marine Corps retail activity or other service inventory activity, if available.

2. Have their source routing rules set to requisition directly to DAASC when not directly supported by an “in-theater” Marine Corps retail activity.

D. General Guidance

1. DoDAACs assigned to contingency task-organized units or provisional units will be for limited periods not to exceed two years. At the end of the two years, the organizing authority will determine if the DoDAAC assigned is still required for the contingency or provisional unit. Recommendations to permanently maintain the DoDAAC must be made through the appropriate channels.

2. Organizations providing equipment in support of contingency task-organization or provisional unit property accounts is not a basis for sourcing/requisitioning military equipment (ME) from agencies outside the MARFOR in which the unit is organized. ME shortfalls will be internally sourced or will be identified to the activity which established the task-organized or provisional unit.

3. ME used to organize a contingency task-organization or provisional unit will not exceed the overall approved acquisition objective (AAO)/Table of Equipment of the activity/MARFOR which established the unit.

050503. Unit Rotations

A rotation of forces involves a relief in place/transfer of authority. As this transfer of authority affects all business processes for which each commander is responsible, it is essential that applicable systems be updated with correct unit information prior to the date of transfer. To facilitate this, updating DoDAAC/UIC associations of the units involved follows a similar process.

A. Unit Deployment Program

In order to ensure uninterrupted business processes for both organizations, DoDAAC updates must be performed within TFSMS, GCSS-MC, and the DoDAAD. Updates to all three systems must occur simultaneously. In order to ensure consistency and proper timing for updating DoDAAC/UIC associations for both units, the following procedures apply:

1. TFSMS Updates. In order to ensure that proper equipment allowance information is fed from TFSMS to GCSS-MC for accurate asset management, the permanent UIC of each command must be associated with the DoDAAC of the equipment set that the unit is falling in on. Example: A deploying unit from 2d Marine Division (MARDIV) must disassociate its UIC from the DoDAAC (equipment set) at Camp Lejeune and associate (align) it with the DoDAAC of a supply account in Okinawa. The reverse actions must occur for a unit deployment program (UDP) unit redeploying from Okinawa to Camp Lejeune. TFSMS updates for both units will be requested by the MAJCOM in the Continental United States (CONUS) via naval message. The request will be



submitted to DC I&L (LPC-2) via the MEF G-4 and will identify the exact date for TFSMS updates to take effect for both commands.

2. GCSS-MC Updates. Similar updates must be performed within GCSS-MC to ensure proper DoDAAC/UIC associations for requisitioning and supply processes. Updates for the deploying and redeploying units must be accomplished by submitting separate Abstract BR-100 forms. Both units must submit their Abstract BR-100 to the MAJCOM G-4. The MAJCOM G-4 will include both Abstract BR-100 forms as attachments to the naval message discussed above. Once the message is received and approved at DC I&L (LPC-2), the Abstract BR-100 forms will be forwarded to MARCORLOGCOM for execution. GCSS-MC updates for both commands will be executed on the same day as the updates within TFSMS.

3. DoDAAD Updates. Finally, updates must be performed within the DoDAAD to display updated DoDAAC/UIC associations for both units as they change location. Accordingly, each unit will submit a DoDAAC Change Request (NAVMC 11718) using the Unit Rotation portion of the form, and submit them to the MAJCOM G-4 in CONUS). The NAVMC 11718 for each unit will be submitted to DC I&L (LPC-2) via the MEF G-4 as the second attachment to the naval message discussed. Once the NAVMC 11718 for each command has been reviewed and approved at DC I&L LPC-2, the forms will be passed to the CSP manager for execution. DoDAAC updates will be executed on the same day as the updates in TFSMS and GCSS-MC.

4. UDP Summary. As a summary, the MAJCOM for both the deploying and redeploying units involved in a UDP rotation will submit a naval message to DC I&L (LPC-2) via the MEF G-4. The body of the message will identify DoDAAC/UIC associations to be updated in TFSMS. The naval message will include requested GCSS-MC updates (Abstract BR-100 forms for each unit) as one attachment; and requested DoDAAC updates (NAVMC 11718) for both units as a separate attachment. DC I&L will approve and forward requested TFSMS updates to DC CD&I (TFSD) for execution. Requested GCSS-MC updates will be forwarded to MARCORLOGCOM for execution. Finally, DoDAAC updates within the DoDAAD will be executed by the CSP at I&L.

**B. Overseas Contingency Operation**

In the case of a RIP/TOA for an overseas contingency operation (OCO), there may be more than two MAJCOMs involved. As such, the Unit Rotation section of the NAVMC 11718 shall be used; however, the request must be properly coordinated between each MAJCOM to ensure that all unit DoDAACs are properly and simultaneously updated coincident with the actual transfer of authority. Careful attention must be given to ensuring that each DoDAAC is properly associated to the correct UIC.

**050504. Deployments Afloat**

Whenever a unit deploys aboard a naval vessel, not only does the DoDAAC need to be updated, but that information needs to be communicated to the Navy to ensure that its systems are similarly updated for cargo routing. The principal system for this information is the Cargo Routing Information File (CRIF). The following guidance is provided to ensure that the unit's address information is correctly reflected in logistics systems.



A. Submit NAVMC 11718

The deploying unit shall submit a completed/approved NAVMC 11718 DoDAAC Change Request to update the unit's DoDAAC information. The NAVMC 11718 must be submitted to the MAJCOM monitor for approval and forwarding to the CSP at DC I&L. Since DoDAAC updates are relatively quick, this process should be communicated at least one week in advance of the date for requested changes.

B. Updates to the Cargo Routing Information File

Supported units shall use the CRIF for cargo routing by ensuring that their TAC-2 freight addresses are loaded to the CRIF prior to deployment. This update is conveyed through both the NAVMC 11718 and notification to the Naval Supply Command via naval message sent from the MAJCOM. The CSP will update the TAC 2 of the unit coincident with the date requested to effect the change, and shall notify the Naval Supply Command of the change. The CSP will coordinate with the Naval Supply Systems Command Logistics Operations Center (NAVSUP LOC) to ensure that the consolidation and containerization point (CCP), aerial port of debarkation (APOD), water port of debarkation (WPOD), & break bulk point (BBP) information submitted by the unit does not conflict with the proper cargo routing intended for the unit. Appendix H provides additional guidance relative to the CRIF and deployments afloat.

**VOLUME 2: CHAPTER 6**

**“DODAAC CHARACTERISTICS AND DATA”**

**SUMMARY OF SUBSTANTIVE CHANGES**

Hyperlinks are denoted by ***bold, italic, blue and underlined font.***

The original publication date of this Marine Corps Order (MCO) Volume (right header) will not change unless/until a full revision of the MCO has been conducted.

All Volume changes denoted in **blue font** will reset to black font upon a full revision of this Volume.

<b>CHAPTER VERSION</b>	<b>PAGE PARAGRAPH</b>	<b>SUMMARY OF SUBSTANTIVE CHANGES</b>	<b>DATE OF CHANGE</b>

**CHAPTER 6**

**DODAAC CHARACTERISTICS AND DATA**

0601 GENERAL

A DoDAAC is a six-position, alpha-numeric code that uniquely identifies a unit, activity, or organization in logistics and financial business systems within DoD DLMS. The first position designates the particular service/agency element of ownership. An alpha character in the first position indicates DoD, and a numeric character in the first position indicates non-DoD. The remaining five positions are assigned by each service's CSP.

0602 DODAAC DATA FIELDS

While the DoDAAC itself is a six-digit, alpha-numeric identifier, this identifier contains a series of over 100 data fields which comprise its pedigree characteristics. The DoDAAD is the ADS for most of these data elements and/or their association to an activity. Since DoD information systems use this data during business operations, it is critical that the data fields be properly identified when new DoDAACs are created. It is equally vital that this information be kept current on an as-occurring basis by units who already have a DoDAAC. Including the DoDAAC as a data field, there are 97 data fields currently in use by the Marine Corps. Following are the data fields which comprise a Marine Corps DoDAAC's pedigree (see also Appendix F):

060201. Unit Identification Code (UIC)

The UIC data field was originally requested by United States Transportation Command (USTRANSCOM) for unit move purposes. For the Marine Corps, however, this field represents either the TFSMS UIC assigned by DC CD&I (TFSD), or the adhoc/provisional UIC assigned by DC PP&O POR to which the DoDAAC will be associated. Every DoDAAC shall be associated to a UIC. TFSMS is the ADS for TFSMS UICs assigned to permanent organizations, and DRRS-MC is the ADS for DC PP&O POR UICs assigned to provisional units.

060202. Authority Code

The authority code is a two-digit code used to restrict requisitioning, shipment, and billing by DoDAAC. It is assigned by DC I&L to identify the authority associated to a DoDAAC necessary to conduct the business processes for which the DoDAAC was originally established. For further information on the assignment of authority codes, see Appendix D. The DoDAAD is the ADS for this data element.

060203. Major Command Code

The MAJCOM code is a two-digit code that designates the MAJCOM to which the unit is subordinate within the DoDAAD. This code is used by MAJCOM DoDAAC monitors to manage unit DoDAACs within each MAJCOM. These codes are synonymous with Command Designator Codes used in supply systems for equipment stratification, and are contained in the latest version of reference (k). See also Appendix C. The DoDAAD is the ADS for this data element.

060204. Combatant Commander

This is a 10-character field that denotes the COCOM to which the unit is attached (i.e., NORTHCOM, etc.). This field is system-generated.

060205. Last Update

This date represents the date that any data field of the DoDAAC was last changed/updated by the CSP.

060206. Procurement Authority Flag

The procurement authority flag is a one-digit field that, when entered with a “Y”, designates that a unit is authorized to write contracts against its DoDAAC. The DoDAAD is the ADS for this data element. Approval for this authority must be requested from, and can only be granted by DC I&L (LB), through the unit’s chain of command. This approval must be granted prior to submitting a DoDAAC request to the CSP. Units without this flag are not authorized to write contracts against their DoDAAC. There are currently 31 Marine Corps DoDAACs that have this authority, which is delegated from Office of the Under Secretary of Defense (OUSD) for Acquisition, Technology and Logistics (AT&L) through the Director of Defense Procurement and Acquisition Policy (DPAP) to the Department of the Navy’s Deputy Assistant Secretary of the Navy for Research, Development and Acquisition. DASN, in turn, delegates this authority for the Marine Corps to DC I&L and the Commander of Marine Corps Systems Command . DC I&L (LB) advises the Commandant in all contracting matters and delegates contract authority to subordinate contracting officers. MARCORSSYSCOM maintains separate contracting authority for purposes of systems/programs acquisition.

060207. Enterprise Identifier Flag

This code is for CSP use and identifies the DoDAAC as an enterprise record. This field is tied to the NEVER REUSE field. The DoDAAD is the ADS for this data element.

060208. Never Reuse

Used by the CSP for non-expiring DoDAACs for use in the Enterprise Unique ID registry. The permanent DoDAAC concept will require two new fields: “Cancelled/Never Reuse Flag” and “Enterprise Identifier Flag.” Neither field will be set within the DoDAAC update page; both will be system-generated.

060209. Routing Identifier Code

The RIC field is no longer used within the DoDAAC’s pedigree.

060210. Communication Routing Identifiers

Communication Routing Identifiers (COMMRI) are codes established by DLA TS which are used to transmit data associated to the DoDAAC. While three COMMRI are listed for a DoDAAC, only two are generally used.

A. Data Pattern or Status COMMRI

Data Pattern (DP) COMMRI are associated to DoDAACs by DLA TS. They are used for the transmission of transactional data submitted against the DoDAAC. The DoDAAD is the ADS for the association of this data element to a DoDAAC/activity.

B. Plain Language Address COMMRI

There are only two Plain Language Address (PLAD) COMMRI used for the Marine Corps. One is used for unclassified transmissions (RHMFIUU), and the other is used for classified transmissions (RHMFISS). In both cases, PLAD information is maintained by the Marine Corps Network Operations and Security Command on behalf of the Defense Information Systems Agency. The PLAD fields in the DoDAAD are no longer used for Marine Corps DoDAACs.

C. Billing COMMRI

Billing for active duty units throughout the Marine Corps is consolidated at DFAS. The DoDAAD is the ADS for the association of this data element to a DoDAAC/activity. The Billing COMMRI for all Marine Corps DoDAACs (other than contractors), unless otherwise specified, is RUQABAS, which correlates to the following TAC 3 address:

DFAS CLEVELAND  
ATTN: USMC JAFBC  
1240 EAST NINTH STREET  
CLEVELAND OH 44199-2055

060211. Operating Materials and Supplies (OM&S) / Military Equipment (ME) Characteristics

A. ME Holding / OM&S Consuming

DoDAACs that hold ME and consume OM&S will be designated as such. These DoDAACs are typically associated with consumer-level supply accounts within the operating forces and supporting establishment.

B. OM&S Holding

OM&S holding DoDAACs will be designated as such on the NAVMC 11718 and recorded in SABRS. For purposes of proper reporting to the United States Standard General Ledger, a DoDAAC cannot hold both ME and OM&S on its property records. These OM&S holding DoDAACs are required to report OM&S levels on a semi-annual basis in accordance with DoD 7000.14R, Department of Defense Financial Management Regulation.

060212. Type of Address Code (TAC) Information

There may be up to four distinct addresses contained in the DoDAAD for each DoDAAC. These distinct delineations are Type of Address Code (TAC) designations. [Note: This should not be confused with “TAC” meaning Transportation Account Code. See reference (i).] Each TAC for a DoDAAC contains specific information relative to the owner of that DoDAAC and is defined as follows:

A. TAC 1

Referred to as owner information, the TAC 1 identifies the mailing address of the owner and correlates to the POC information contained for the DoDAAC. The U.S. Postal Service maintains the official repository of permanent mailing addresses. DC M&RA establishes policy for proper mailing addresses of all Marine Corps activities in accordance with reference (n). The Military Postal Service Agency establishes and maintains all deployed mailing addresses (the U.S. Army is the executive agent). Units requiring changes to their TAC 1, or new addresses for deployed contingencies, should notify their postal officer to obtain the valid mailing address. This information should then be submitted for inclusion in the DoDAAC. The DoDAAD is the ADS for the association of this address information to a unit for logistics and financial systems. Each requisitioning activity must have a TAC 1 address. TAC 1 address information fields are as follows:

1. Line 1. Thirty-five-character field, first line of the mailing address of the unit, activity, or organization that is authorized to order/requisition material from the DoD Logistics System. Authorized conventions for TAC 1 Line 1 are: COMMANDANT, COMMANDER, COMMANDING GENERAL, COMMANDING OFFICER, DIRECTOR, INSPECTOR-INSTRUCTOR, or OFFICER IN CHARGE.

2. Line 2. Thirty-five-character field, the second line of the mailing address of the unit, activity, or organization that is authorized to order/requisition material from the DoD Logistics System. This is usually an abbreviated rendering of the unit’s name. Examples include: 7TH ENGRSPTBN, 3RD DENBN, 2ND ANGLICO, 1ST CBT ENGRSPTBN, II MHG, etc.

3. Line 3. Thirty-five-character field, the third line of the mailing address of the unit, activity, or organization that is authorized to order/requisition material from the DoD Logistics System (normally the street address). Examples include: PSC 2017, PO BOX 15320, 3D STREET MCAS, 1401 VANDEGRIFT BLVD MCB, etc. Note, it may also include building number, but should at least include either a post office box or street address.

4. Line 4. Thirty-five-character field, the fourth line of the mailing address of the unit, activity, or organization that is authorized to order/requisition material from the DoD Logistics System. The fourth line is generally created by the system by virtue of data entered for City, State, and ZIP Code fields.

5. Line 5. Thirty-five-character field, the fifth line of the mailing address of the unit, reserved solely for the country name associated with the International Organization for Standardization (ISO) 3166-1 country code and is automatically created for the Military Shipping Label (MSL) by the other data elements of the TAC. The MSL supports five lines, and United States Postal Service (USPS) requires that the country name be spelled out in English on the last line of the address.

6. City of TAC 1 mailing address. City of mailing address.

7. State of TAC 1 mailing address. This is a two-position alpha code of the state in the mailing address. If the address is outside of the United States it will be null.

8. ZIP Code of TAC 1 mailing address. United States Parcel Postal Code of the mailing address, expressed as either a five-position code or ten-position with a hyphen after the fifth position.

9. Two-digit International Organization for Standardization (ISO) Country Code. The code is assigned by ISO and is the most widely accepted of the different country code standards maintained within the DoDAAD.

10. Three-digit ISO Country Code. The code is assigned by ISO.

11. International Postal Code. There are two postal code fields in the DoDAAC. The ZIP is used exclusively for United States postal codes. The International Postal Code (IPC) ZIP is used for all other countries. Postal code data for non-US countries can be obtained by contacting the country's post office directly.

12. Effective Date. In Julian date format (yyyyddd), this is the date upon which the address became effective. The effective date is provided in the Plan of Action and Milestones (POAM) requirement stipulated by the MCBUL 5400 or as specified on the Government-issued contract).

13. Delete Date. In Julian date format (yyyyddd), this is the date upon which the address was deleted. After this date, the address is no longer valid. The delete date is provided in the POAM requirement stipulated by the MCBUL 5400, or as specified on the government-issued contract.

14. MILSTRIP Country Code. This is a two-character MILSTRIP country code. The code is assigned by DoD and is published in reference [\(f\)](#).

15. Foreign Military Sales (FMS) Country Code. This is a two-character FMS country code. The code is assigned by DoD and is published in reference [\(f\)](#).

B. TAC 2

Referred to as ship-to information, the TAC 2 identifies the ship-to or freight address for the activity (when the in-the-clear freight shipping address differs from the TAC 1). If no ship-to information is entered, the TAC 1 address is used. If the activity's shipping/receiving is serviced by a Distribution Management Office (DMO) or Traffic Management Office (TMO), the information of the DMO/TMO would be used for the TAC 2. A TAC 2 is required for all overseas activities, to include BBP, CCP, APOD, and WPOD. Assistance in determining the proper BBP, CCP, APOD, and WPOD should be obtained from the transportation office supporting the unit concerned. If additional assistance is required, units should contact the Marine Corps DoDAAD CSP by message. The DoDAAD is the ADS for the association of this address information to a unit for logistics and financial systems. CONUS TAC 2 addresses will include a standard point location code which will be assigned by the Marine Corps CSP. TAC 2 address information fields are as follows:

1. Line 1. Thirty-five-character field, the first line of the shipping address of the ship-to activity. Examples include: TRAFFIC MANAGEMENT OFFICER, SUPPLY OFFICER, COMMANDING OFFICER, etc.

2. Line 2. Thirty-five-character field, the second line of the ship-to activity, usually the name of the shipping/receiving activity. Examples include: MATERIAL DISTRIBUTION CENTER, 2D SUPPLY BN, MCAS NEW RIVER, etc.

3. Line 3. Thirty-five-character field, the third line of the mailing address of the ship-to activity (normally the street address). This cannot be a PO Box or PSC. It must be a physical location. It should include a street address, but in the absence of such, a building number should be provided, and/or a "Mark For" and the unit or DoDAAC for whom the shipping/receiving is being performed.

4. Line 4. Thirty-five-character field, the fourth line of the ship-to address of the unit, activity, or organization that is authorized to receive material from the DoD Logistics System. This line is generally created by the system by virtue of data entered for City, State, and ZIP Code fields.

5. Line 5. Thirty-five-character field, the fifth line of the ship-to address of the unit, reserved solely for the country name associated with the ISO 3166-1 country code, and automatically created for the MSL by the other data elements of the TAC. The MSL supports five lines, and USPS requires the country name to be spelled out in English on the last line of the address.

6. City of TAC 2 address. City of ship-to address.

7. State of TAC 2 address. This is a two-position alpha code of the state in the ship-to address. If the address is outside the United States it will be null.

8. ZIP Code of TAC 2 address. United States Parcel Postal Code of the ship-to address, expressed as either a five-position code or ten-position with a hyphen after the fifth position.



9. Two-digit ISO Country Code. The code is assigned by ISO and is the most widely accepted of the different country code standards maintained within the DoDAAD.

10. Three-digit ISO Country Code. The code is assigned by ISO.

11. International Postal Code. There are two postal code fields in the DoDAAC. The ZIP is used exclusively for United States postal codes. The IPC ZIP is used for all other countries. Postal code data for non-US countries can be obtained by contacting the country's post office directly.

12. Effective Date. In Julian date format (yyyyddd), this is the date upon which the address became effective. The effective date is provided in the POAM requirement stipulated by the MCBUL 5400 or as specified on the Government-issued contract).

13. Delete Date. In Julian date format (yyyyddd), this is the date upon which the address was deleted. After this date, the address is no longer valid. The delete date is provided in the POAM requirement stipulated by the MCBUL 5400 or as specified on the Government-issued contract.

14. MILSTRIP Country Code. This is a two-character MILSTRIP country code. The code is assigned by DoD and is published in reference [\(f\)](#).

15. Foreign Military Sales Country Code. This is a two-character country code. The code is assigned by DoD and is published in reference [\(f\)](#).

C. TAC 3

Referred to as bill-to information, the TAC 3 identifies the billing address or the activity responsible for payment of bills. If no bill-to information is entered, the TAC 1 address is used. The DoDAAD is the ADS for the association of this address information to a unit for logistics and financial systems. TAC 3 address information fields generally follow the same conventions as that used for TAC 1 which are as follows:

1. Line 1. Thirty-five-character field, the first line of the mailing address of activity that will make payment (bill to address).

2. Line 2. Thirty-five-character field, the second line of activity that will make payment (bill to address).

3. Line 3. Thirty-five-character field, the third line of the mailing address of activity that will make payment (bill to address).

4. Line 4. Thirty-five-character field, the last line of the mailing address of activity that will make payment (bill to address).

5. Line 5. Thirty-five-character field, the fifth line of the billing address of the unit, reserved solely for the country name associated with the ISO 3166-1 country code and automatically created for the MSL by the other data elements of the TAC. The MSL supports five lines, and USPS requires the country name to be spelled out in English on the last line of the address.

6. City of TAC 3 billing address. City of mailing address.

7. State of TAC 3 billing address. Two-position alpha code of the state in the mailing address. If the address is outside the United States it will be null.

8. ZIP Code of TAC 3 billing address. United States Parcel Postal Code of the mailing address, expressed as either a five-position code or ten-position with a hyphen after the fifth position.

9. Two-digit ISO Country Code. The code is assigned by ISO and is the most widely accepted of the different country code standards maintained within the DoDAAD.

10. Three-digit ISO Country Code. The code is assigned by ISO.

11. International Postal Code. There are two postal code fields in the DoDAAC. The ZIP is used exclusively for United States postal codes. The IPC ZIP is used for all other countries. Postal code data for non-US countries can be obtained by contacting the country's post office directly.

12. Effective Date. In Julian date format (yyyyddd), this is the date upon which the address became effective. The effective date is provided in the POAM requirement stipulated by the MCBUL 5400 or as specified on the Government-issued contract).

13. Delete Date. In Julian date format (yyyyddd), this is the date upon which the address was deleted. After this date, the address is no longer valid. The delete date is provided in the POAM requirement stipulated by the MCBUL 5400 or as specified on the Government-issued contract).

14. MILSTRIP Country Code. This is a two-character MILSTRIP country code. The code is assigned by DoD and is published in reference [\(f\)](#).

15. Foreign Military Sales Country Code. This is a two-character country code. The code is assigned by DoD and is published in reference [\(f\)](#).

#### D. TAC 4

Referred to as commercial small parcel shipping information, the TAC 4 identifies the commercial shipping address (e.g., address used by the USPS, United Parcel Services, Federal Express, etc.). If no commercial shipping information is entered, the TAC 2 is used. The DoDAAD is the ADS for the association of this address information to a unit for logistics and financial systems. TAC 4 address information fields are as follows:

1. Line 1. Thirty-five-character field, the first line (normally the unit name) of the mailing address used for delivery of small parcel carriers (used only when the TAC 2 address is not sufficient for delivery).

2. Line 2. Thirty-five-character field, the second line (normally the street address) of the mailing address used for delivery of small parcel carriers (used only when the TAC 2 address is not sufficient for delivery).

3. Line 3. Thirty-five-character field, the third line of the mailing address used for delivery of small parcel carriers (used only when the TAC 2 address is not sufficient for delivery).

4. Line 4. Thirty-five-character field, the last line of the mailing address used for delivery of small parcel carriers (used only when the TAC 2 address is not sufficient for delivery).

5. Line 5. Thirty-five-character field, the fifth line of the billing address of the unit, reserved solely for the country name associated with the ISO 3166-1 country code and automatically created for MSL by the other data elements of the TAC. The MSL supports five lines, and USPS requires the country name to be spelled out in English on the last line of the address.

6. City of TAC 4 address. City of mailing address.

7. State of TAC 4 address. This is a two-position alpha code of the state in the mailing address. If the address is outside the United States it will be null.

8. ZIP Code of TAC 4 address. United States Parcel Postal Code of the mailing address, expressed as either a five-position code or ten-position with a hyphen after the fifth position.

9. Two-digit ISO Country Code. The code is assigned by ISO and is the most widely accepted of the different country code standards maintained within the DoDAAD.

10. Three-digit ISO Country Code. The code is assigned by ISO.

11. International Postal Code. There are two postal code fields in the DoDAAC. The ZIP is used exclusively for United States postal codes. The IPC ZIP is used for all other countries. Postal code data for non-US countries can be obtained by contacting the country's post office directly.

12. Effective Date. In Julian date format (yyyddd), this is the date upon which the address became effective. The effective date is provided in the POAM requirement stipulated by the MCBUL 5400 or as specified on the Government-issued contract).

13. Delete Date. In Julian date format (yyyyddd), this is the date upon which the address was deleted. After this date, the address is no longer valid. The delete date is provided in the POAM requirement stipulated by the MCBUL 5400 or as specified on the Government-issued contract).

14. MILSTRIP Country Code. This is a two-character MILSTRIP country code. The code is assigned by DoD and is published in reference [\(f\)](#).

15. Foreign Military Sales Country Code. This is a two-character country code. The code is assigned by DoD and is published in reference [\(f\)](#).

060213. Transportation Information

The following fields provide additional transportation data for the DoDAAC:

A. Consolidation and Containerization Point

The CCP three-character code is used for shipping purposes when supplies are shipped via surface freight. The code is defined in reference [\(q\)](#). Currently there are only two valid values for a CCP: 101 (East Coast Consolidation Point, address found in DoDAAC W25N14), or 301 (West Coast Consolidation Point, address found in DoDAAC W62N2A). Every outside CONUS (OCONUS) DoDAAC will either have 101 or 301 assigned. CCPs are not assigned to CONUS DoDAACs. The DoDAAD is the ADS for the association of this data element to a DoDAAC/activity.

B. Standard Point Location Code

The Standard Point Location Code is a system-generated, nine-character field which denotes a CONUS location capable of processing shipments. It is assigned by the National Motor Freight Traffic Association and is associated with a DoDAAC based on the TAC 2 shipping address (TAC 1 if TAC 2 does not exist). The DoDAAD is the ADS for this information.

C. Geo-Location

This field is no longer used.

D. Break Bulk Point

The BBP is the location that material is shipped to and broken into smaller shipments for onward movement. For units who are supported by consolidated shipping/receiving, the BBP is the DoDAAC of the Shipping & Receiving activity (i.e., DMO/TMO, etc.).

E. Air Lines of Communication

The Air Lines of Communication code is a one-character field assigned by the Army. The DoDAAD is the ADS for this information.

F. Bill of Lading Office Code

The Bill of Lading Office Code (BLOC) is a four-character code defined in reference (q) and can be downloaded from the USTRANSCOM Table Management Distribution System (TMDS) website. The DoDAAD logic was changed in 2009 to directly load the BLOC from TMDS, so the CSP no longer directly enters this data.

G. CONUS or OCONUS

This one-character field (“C” or “O”) simply denotes whether or not the unit is within the CONUS or OCONUS. It is system-generated.

H. Aerial Port of Debarkation

The APOD code is defined in the Defense Transportation Regulation (DTR). DLA TS downloads a table of APOD information from USTRANSCOM to load the drop-down values in the DoDAAD update application. A new copy of the APOD is downloaded every time the table is updated by USTRANSCOM.

I. Water Port of Debarkation

The WPOD code is defined in the DTR. DLA TS downloads a table of WPOD information from USTRANSCOM to load the drop-down values in the DoDAAD update application. A new copy of the WPOD is downloaded every time the table is updated by USTRANSCOM.

060214. Plain Language Address Information

The DoDAAC no longer uses this information.

060215. Contract Information

In order to create “L” DoDAACs for contractors supporting the Marine Corps, the following additional fields are required. Once the DoDAAC is created, the DoDAAD is the ADS for the association of these data elements to an activity for logistics and financial systems:

A. Contract Number

This is a 17-character field used to enter the current valid support contract for which the DoDAAC was created. Multiple contracts can be associated to a single DoDAAC; however, only one contract will be resident in the DoDAAD. This should be the longest running contract.

B. Contract Expiration Date

This is a seven-character field used to enter the expiration date of the support contract for which the DoDAAC was created. Upon creation by the CSP, the DoDAAC is set to automatically delete on this date.

C. Contract Sponsor

This is a nine-character field used to enter the major command who funded the contract, which is usually the command being supported by the contract. For the Marine Corps, the requisitioning DoDAAC funding the contract is entered.

D. Contract Administration Office

This is a six-character field denoting the DoDAAC of the Contract Administration Office that wrote the contract (the procurement authority).

E. Commercial and Government Entity Code

The Commercial and Government Entity (CAGE) Code is a five-character field provided to enter CAGE code of the contractor (or government activity, if applicable). All contractors must have a valid CAGE registered in the Central Contract Registration (CCR) in order to acquire a DoDAAC.

060316. Point of Contact Information

The DoDAAC provides three mandatory data fields for POC information:

A. POC

This is a 30-character field used to provide the rank/title/name of the unit/activity POC for the DoDAAC. DoDAACs with an authority code of "00," must have the appointed APO / supply officer listed as the POC for that respective DoDAAC in the DoDAAD.

B. E-mail

This is a 40-character field used to provide the e-mail address of the unit/activity POC for the DoDAAC.

C. Phone

This is a 21-character field used to provide the telephone number for the unit/activity POC for the DoDAAC. Note: the system only recognizes 10-digit phone number configurations.

060317. CSP Managed Fields

The following additional fields are part of a DoDAAC's pedigree that is managed by the CSP:

A. Accounting Disbursing Station Number/Fiscal Station Number

This six-character code identifies the service payment office. This field is not validated within the DoDAAD; it is service-defined and service-dependent. The Army and Air Force set a five-digit numeric code; the Navy and Marine Corps mostly use a DoDAAC; DLA and other agencies use a mix of numeric codes and DoDAACs. For the Marine Corps, 067443 is used for all DoDAACs except for MARCORLOGCOM DoDAACs that use Navy Working Capital Fund, in which case 067004 is used. The DoDAAD is the ADS for this information.

B. Free Form

One-character field used to denote free form used.

C. Notes

Four-thousand-character, free-form field for CSP notes. Only the CSP has visibility of this field.

060218. Classified Addresses

Classified addresses have distinct open issues for which the guidance published in the DLMS order, reference [\(g\)](#) applies.

0603 EXAMPLES

The following are examples of correctly rendered TAC information:

060301.	<u>TAC 1</u>	Owner Information
A.	M12200	COMMANDER CJTF HOA CAMP LEMONIER DJIBOUTI APO AE 09363
B.	MMA100	OFFICER IN CHARGE MAINT FLOT ACCT, CODE 570 814 RADFORD BLVD STE 20301 ALBANY GA 31704-0301
C.	M28020	COMMANDING OFFICER 3D SUPPLY BN 3D MLG FMFPAC UNIT 38416 FPO AP 96604-8416

13 JUN 2016

060302. TAC 2

All Marine Corps commanders with requisition authority shall submit a TAC 2 address designating the supporting traffic management/ receiving address. Examples of TAC 2 addresses for the preceding TAC 1 addressees are:

A. M12200 TRAFFIC MANAGEMENT OFFICER  
CJTF HOA  
OPERATION ENDURING FREEDOM  
CAMP LEMONIER DJIBOUTI 09351

B. MMA100 OFFICER IN CHARGE  
MF MMA100 IIP TEL 229 639 6659  
BUILDING 1260 BAY 1 DOOR 1  
ALBANY GA 31704

C. TAC 2 OCONUS. Overseas activities cannot use a PO Box. They must include the complete geographic location along with the name of the unit and primary organization to which identified, including the APOD, WPOD, CCP, and BBP.

M28020 OFFICER IN CHARGE  
MATERIAL DISTRIBUTION CENTER  
MF M28020, BLDG 400, CAMP KINSER  
OKINAWA JP 901 2100

D. TAC 2 (Activities Aboard Navy Ships). Per the information contained in reference [\(p\)](#), reference [\(q\)](#) and Appendix H to this policy, units embarked aboard naval vessels shall use the following TAC 2 address:

M11110 CALL NAVSUP GLS TRANSPORTATION  
CML 757 443 5434 DSN 646 5434  
OUTCONUS 312 646 5434

060303. TAC 3

The proper TAC 3 for most Marine Corps activities is as follows:

M28020 DFAS CLEVELAND  
ATTN: USMC JAFBC  
1240 EAST NINTH STREET  
CLEVELAND OH 44199-2001



060304.      TAC 4

When used, the TAC 4 shall utilize the TAC 1 information but may include more specific or commercial carrier-recognizable information to ensure commercial parcels can be delivered to an exact location within an activity.

M01264      UNITED STATES MARINE CORPS  
                 VMM 264 MAG 26 2ND MAW  
                 BUILDING AS-515 RM 295  
                 MCAS NEW RIVER NC 28545-1016

0604    DODAAC AND RIC QUERIES

Activities and commands may review their DoDAAC and RIC information in the DoDAAD using the DLA TS website's DAASC Inquiry System (DAASINQ). See Figures 6-1 and 6-2 below.

DODAAC INFORMATION			
DoDAAC:	M21500		
DODAAD SERVICE/AGENCY:	MARINE S		
AUTHORITY CODE:	00 - Requisitioner	UIC:	M21500
MAJ COMMAND:	M1 - I MEF		
COCOM:	USNORTHCOM	LAST UPDATE:	05-APR-12
PROCUREMENT AUTHORITY FLAG:	No		
ENTERPRISE IDENTIFIER FLAG:	No	CANCELLED/NEVER REUSE FLAG:	No
RIC:			
COMMR(s) INFORMATION			
DP:	<a href="#">RU\$AHUO</a>	PLAD:	<a href="#">RU\$VICBD</a>
		BILL:	<a href="#">RU\$GABA\$</a>
TAC INFORMATION			
T A C 1	<ul style="list-style-type: none"> <li>• COMMANDING OFFICER</li> <li>• 7TH ESB 1ST MLG</li> <li>• BOX 555677</li> <li>• CAMP PENDLETON CA 92055-5677</li> <li>•</li> </ul>		EFF DATE: 01/26/2009 DEL DATE:
	CITY: CAMP PENDLETON	ZIP: 92055-5677	IPC ZIP: CA06
	STATE/APO/PROVINCE: California		STATE(A/N)/PROVINCE: CA06
	COUNTRY NAME: UNITED STATES		
ISO CC: U\$U\$A	MIL \$ CC:	FIP \$ CC: U\$	FM \$ CC:
T A C 2	<ul style="list-style-type: none"> <li>• TRAFFIC MANAGEMENT OFFICER</li> <li>• MF SUP OFF 7TH ESB 1ST MLG M21500</li> <li>• BLDG 140173 MCB PHONE 760 725 5349</li> <li>• CAMP PENDLETON CA 92055-5627</li> <li>•</li> </ul>		EFF DATE: 01/26/2009 DEL DATE:
	CITY: CAMP PENDLETON	ZIP: 92055-5627	IPC ZIP: CA06
	STATE/APO/PROVINCE: California		STATE(A/N)/PROVINCE: CA06
	COUNTRY NAME: UNITED STATES		
ISO CC: U\$U\$A	MIL \$ CC:	FIP \$ CC: U\$	FM \$ CC:
T A C 3	<ul style="list-style-type: none"> <li>• DFAS CLEVELAND</li> <li>• ATTN: USMC JAFBC</li> <li>• 1240 EAST NINTH STREET</li> <li>• CLEVELAND OH 44199-2055</li> <li>•</li> </ul>		EFF DATE: 05/27/2011 DEL DATE: ADSNF\$N:
	CITY: CLEVELAND	ZIP: 44199-2055	IPC ZIP: OH09
	STATE/APO/PROVINCE: Ohio		STATE(A/N)/PROVINCE: OH09
	COUNTRY NAME: UNITED STATES		
ISO CC: U\$U\$A	MIL \$ CC:	FIP \$ CC: U\$	FM \$ CC:
T A C 4	<ul style="list-style-type: none"> <li>•</li> <li>•</li> <li>•</li> <li>•</li> <li>•</li> </ul>		EFF DATE: DEL DATE:
	CITY:	ZIP:	IPC ZIP:
	STATE/APO/PROVINCE:		STATE(A/N)/PROVINCE:
	COUNTRY NAME:		
ISO CC:	MIL \$ CC:	FIP \$ CC:	FM \$ CC:
TRANSPORTATION INFORMATION			
CCP:		SPLC:	885513290
GEO LOCATION:		BBP:	
DSS ALOC:		BLOC:	
CONUS/OCONUS: C	WPOD:	APOD:	
PLAD INFORMATION			
PLA:	SEVENTH ENGR SPTBN		
DEL DATE:		EFF DATE:	03/14/1997
CONTRACT INFORMATION			
Note: If multiple contracts are authorized use of this DoDAAC, only the longest running contract is recorded and displayed.			
CONTRACT NO:	CAGE CODE:	EXP DATE:	
ADMIN OFF:	CONTRACTING SERVICE/AGENCY:		
POC INFORMATION			
POC:			
PHONE:			

Figure 6-1. DoDAAC Query Search Results from DAASC Inquiry System (DAASINQ)

RIC INFORMATION					
RIC:	MPB	RIC DODAAC:	<a href="#">M98820</a>		
DODAAD SERVICE/AGENCY:	MARINE				
MAJ COMMAND:	C5 - MCLC				
COCOM:	USNORTHCOM	LAST UPDATE:	03-MAR-12		
COMMRI(s) INFORMATION					
DP:	<a href="#">RUQABNB</a>				
TAC INFORMATION					
T A C 1	<ul style="list-style-type: none"> <li>• COMMANDER</li> <li>• MCLC, WPN SYSTEMS MGMT CTR, P70</li> <li>• 814 RADFORD BLVD STE 20320</li> <li>• ALBANY GA 31704-0320</li> <li>• </li> </ul>				EFF DATE: 03/02/2012
					DEL DATE:
	CITY:	ALBANY	ZIP:	31704-0320	IPC ZIP:
	STATE/APO/PROVINCE:	Georgia	STATE(A/N)/PROVINCE:	GA/13	
	COUNTRY NAME:	UNITED STATES			
	ISO CC: US/USA	MILS CC:	FIPS CC: US	FMS CC:	

Figure 6-2. RIC Query Search Results from DAASC Inquiry System (DAASINQ)

**VOLUME 2: CHAPTER 7**

**“ROUTING IDENTIFIER CODE CHARACTERISTICS AND DATA”**

**SUMMARY OF SUBSTANTIVE CHANGES**

Hyperlinks are denoted by ***bold, italic, blue and underlined font.***

The original publication date of this Marine Corps Order (MCO) Volume (right header) will not change unless/until a full revision of the MCO has been conducted.

All Volume changes denoted in **blue font** will reset to black font upon a full revision of this Volume.

<b>CHAPTER VERSION</b>	<b>PAGE PARAGRAPH</b>	<b>SUMMARY OF SUBSTANTIVE CHANGES</b>	<b>DATE OF CHANGE</b>

**CHAPTER 7**

**ROUTING IDENTIFIER CODE CHARACTERISTICS AND DATA**

0701 ROUTING IDENTIFIER CODES

A RIC is a three-digit, alpha-numeric code that uniquely identifies a unit, activity, or organization that requires the ability to route transactions or receive transactions routed to it (e.g., source of supply) within logistics and financial business systems within DLMS and DLSS. The first position designates the particular service/agency element of ownership. An alpha character in the first position indicates DoD, and a numeric character in the first position indicates non-DoD. The remaining two positions are assigned by each service's CSP.

0702 PURPOSE

RICs serve multiple purposes in that they are supply source codes, intersystem routing codes, and consignor (shipper) codes. RICs are three-character codes associated with a DoDAAC and a unique seven-character COMMRI for routing purposes. There may be more than one RIC associated with a single DoDAAC; however, each individual RIC may be associated with only one DoDAAC. RICs are entered into the DoDAAD with a three-character prefix "ZZZ." RICS are discussed in Appendix 2.03 of reference (f).

0703 RIC DATA FIELDS

While the RIC itself is a three-digit, alpha-numeric identifier, this identifier represents a series of 24 data fields which comprise its pedigree characteristics. The DoDAAD is the ADS for most of these data elements and/or their association to an activity. Since activities within DoD information systems use this data to conduct business with the unit represented by the RIC, it is critical that the data fields are properly identified when a new RIC is created. It is equally vital that this information be kept current on an as-occurring basis by units who already have a RIC. Including the RIC as a data field, there are 24 fields currently in use by the Marine Corps. The following are the data fields which comprise a Marine Corps RIC's pedigree (see also Appendix F of this Volume):

070301. RIC DoDAAC

Every RIC must be associated to a DoDAAC. Since a RIC only has one Type of Address Code (TAC), the TAC of the RIC will always be the same as the TAC 1 of the DoDAAC to which it is associated. Every other data element of the RIC will also be the same as the DoDAAC to which the RIC is associated (i.e., MAJCOM code, status COMMRI, etc.).

070302. Major Command Code

Just as with DoDAACs, every RIC has a MAJCOM code which will be the same as that of the RIC's DoDAAC.

070303.      Creation Date

This date appears in the system to capture the date that the RIC was created.

070304.      Data Pattern or Status COMMRI

DP COMMRI are associated to RICs and DoDAACs by DLA TS. They are used for the transmission of transactional data submitted against the RIC/DoDAAC. The DoDAAD is the ADS for the association of this data element to a RIC/DoDAAC/activity.

070305.      Combatant Commander

This is a 10-character field that denotes the COCOM to which the unit is attached (i.e., NORTHCOM, etc.). This field is system-generated.

070306.      Last Update

This date represents the date that any data field of the RIC was last changed/updated by the CSP.

070307.      TAC 1

Referred to as owner information, the TAC 1 identifies the mailing address of the owner, and correlates to the POC information contained for the DoDAAC. DC M&RA establishes policy for proper mailing addresses of all Marine Corps activities per reference [\(n\)](#). Units requiring changes to their TAC 1, or who require new addresses for deployed contingencies should notify their postal officer to obtain the valid mailing address. This information should then be submitted for inclusion in the DoDAAC. The DoDAAD is the ADS for the association of this address information to a unit for logistics and financial systems. Each requisitioning activity must have a TAC 1 address with a TAC 2 and TAC 3. Additionally, the TAC 1 shall be used for CONUS freight shipments if no TAC 2 is listed. The TAC 1 of a RIC will always be the same as its corresponding DoDAAC. TAC 1 address information fields are as follows:

A.      Line 1

Thirty-five-character field, first line of the mailing address of the unit, activity, or organization that is authorized to order/requisition material from the DoD logistics system. Authorized conventions for TAC 1 Line 1 are: COMMANDANT, COMMANDER, COMMANDING GENERAL, COMMANDING OFFICER, DIRECTOR, INSPECTOR-INSTRUCTOR, or OFFICER IN CHARGE.

B. Line 2

Thirty-five-character field, the second line of the mailing address of the unit, activity, or organization that is authorized to order/requisition material from the DoD logistics system. This is usually an abbreviated form of the unit's name. Examples include: 7TH ENGRSPTBN, 3RD DENBN, 2ND ANGLICO, 1ST CBT ENGRSPTBN, II MHG, etc.

C. Line 3

Thirty-five-character field, the third line of the mailing address of the unit, activity, or organization that is authorized to order/requisition material from the DoD logistics system (normally the street address). Examples include: PSC 2017, PO BOX 15320, 3D STREET MCAS, 1401 VANDEGRIFT BLVD MCB, etc. Note: it may also include building number, but should at least include either a PO or Street address.

D. Line 4

Thirty-five-character field, the fourth line of the mailing address of the unit, activity, or organization that is authorized to order/requisition material from the DoD logistics system. The fourth line is generally created by the system by virtue of data entered for City, State, and ZIP fields.

E. Line 5

Thirty-five-character field, the fifth line of the mailing address of the unit, reserved solely for the country name associated with the ISO 3166-1 country code and automatically created for the MSL by the other data elements of the TAC. The MSL supports five lines, and the USPS requires the country name to be spelled out in English on the last line of the address.

F. City of TAC 1 mailing address

City of mailing address.

G. State of TAC 1 mailing address

This is a two-position alpha code of the state in the mailing address. If the address is outside of the United States it will be null.

H. ZIP Code of TAC 1 mailing address

United States parcel postal code of the mailing address, expressed as either a five-position code or ten-position with a hyphen after the fifth position.

I. Two-digit International Organization for Standardization (ISO) Country Code.

This code is assigned by ISO and is the most widely accepted of the different country code standards maintained within the DoDAAD.

J. Three-digit ISO Country Code

This code is assigned by ISO.

K. International Postal Code

There are two postal code fields in the DoDAAC. The ZIP Code is used exclusively for United States Postal codes. The IPC ZIP is used for all other countries. Postal code data for non-US countries can be obtained by contacting the country's post office directly.

L. Effective Date

In Julian format (yyyyddd), the date upon which the address became effective.

M. Delete Date

In Julian format (yyyyddd), the date upon which the address was deleted. After this date this address is no longer valid. NOTE: If a DoDAAC is deleted that also has a RIC associated to it, the CSP will also delete the associated RIC.

N. MILSTRIP Country Code

This is a two-character MILSTRIP country code. The code is assigned by DoD and is published in reference (f).

O. Foreign Military Sales Country Code

This is a two-character FMS country code. The code is assigned by DoD and is published in reference (f).

070308. Central Service Point-Managed Fields

The following additional fields are part of a RIC's pedigree and are managed by the CSP:

A. Free Form

One-character field used to denote free form used.

B. Notes

4,000-character, free form field for CSP notes. Only the CSP has visibility of this field.



**VOLUME 2: CHAPTER 8**

**“DODAACS AND UICS”**

**SUMMARY OF SUBSTANTIVE CHANGES**

Hyperlinks are denoted by *[bold, italic, blue and underlined font.](#)*

The original publication date of this Marine Corps Order (MCO) Volume (right header) will not change unless/until a full revision of the MCO has been conducted.

All Volume changes denoted in *blue font* will reset to black font upon a full revision of this Volume.

<b>CHAPTER VERSION</b>	<b>PAGE PARAGRAPH</b>	<b>SUMMARY OF SUBSTANTIVE CHANGES</b>	<b>DATE OF CHANGE</b>

## **CHAPTER 8**

### **DODAACS AND UICS**

#### **0801 GENERAL**

Since the relationship between DoDAACs and UICs in the Marine Corps can be complex, the following information is provided specifically to address the use of and interrelationship between these two identifiers. Unlike a UIC, a DoDAAC is used to enable a business process on behalf of an organization within logistics, financial, acquisition, and services systems that are part of, linked to, or use the data constructs of DLMS, DLSS, and/or MILS portfolio of systems (i.e., MILSTRIP MILSTRAP, Military Standard Billing System (MILSBILLS), etc.). The DoDAAC is the DoD business standard used to identify an activity within these systems.

#### **0802 AUTHORITY**

Since a DoDAAC is used to enable a business process, it is tied to the authority behind that business process and the laws, statutes, and regulations which govern the business process, to include how resources (i.e., appropriations, property, and materiel) associated to the DoDAAC are utilized and managed per reference [\(b\)](#), [\(d\)](#), [\(l\)](#), [\(m\)](#), [\(o\)](#) and [\(r\)](#). Appendix A of this Volume outlines the DoDAAC's relationship to a commander's authority.

#### **0803 DODAAC USES**

All Marine Corps approved APSRs will align and account for equipment and materiel at the accountable officer's/commander's DoDAAC level. A UIC or RUC will not be used for accountability of resources. The following interrelationships of DoDAACs and UICs are provided. See also Appendix I of this Volume.

##### **080301. Financial**

A financial UIC is a five-digit code created by DFAS on behalf of the DON. Whenever a Marine Corps activity has a business process that ties back to a Navy system, that activity must be registered in the Navy's system(s) via a financial UIC and a DoDAAC. The following guidance is provided:

##### **A. Bureau Control Number**

Every MRI, ARI, and SRI in SABRS is a BCN, and is registered as a UIC in the DFAS UIC list. When the Marine Corps requires a new BCN for a command, a request will be forwarded to the DC I&L, (LPC) via DC P&R (RFA). The request will identify the code required and its intended relationship within SABRS hierarchy (i.e., MRI/ARI/SRI). See figure 8-1. DC I&L (LPC) will submit a Navy UIC/DoDAAC Request to DFAS (via e-mail to [UIC/DoDAAC@DFAS.MIL](mailto:UIC/DoDAAC@DFAS.MIL)) (see Appendix G of this Volume). DFAS will process the request and provide a notification back to DC I&L (LPC) (via e-mail to [USMCDoDAACMGR@USMC.MIL](mailto:USMCDoDAACMGR@USMC.MIL)) of the new UIC/BCN. The CSP manager at DC I&L will then create an "M"-series DoDAAC utilizing the BCN/SRI and assign it authority code 05. Once created, DC I&L (LPC) will then notify DC,

**MANAGEMENT OF PROPERTY IN THE POSSESSION OF THE MARINE CORPS  
Volume 2, Chapter 8**

**MCO 4400.201-V2**

**13 JUN 2016**

P&R (RFA) (via e-mail to [SABRSTABLESANDACCESS@USMC.MIL](mailto:SABRSTABLESANDACCESS@USMC.MIL)) of the new DoDAAC to be used as the new BCN/SRI (or MRI/ARI as necessary) within SABRS. DC I&L (LPC) will also notify the requestor and all other stakeholders impacted by the new DoDAAC. Every MRI/ARI/SRI will be assigned authority code 00. MRIs, ARIs, and SRIs can all be the same DoDAAC. See figure 8-1 and Appendix A of this Volume.

**B. Work Center Identifier**

Whenever a DoDAAC is required for use as a WCI within SABRS, a request will be forwarded to the CSP at DC I&L (LPC), via DC P&R (RFA), to approve and create the DoDAAC using authority code 02. Once created, DC I&L (LPC) will notify DC P&R (RFA) as noted above. WCIs cannot be the same as an MRI/ARI/SRI or AAC. See also figure 8-1 below and Appendix A of this Volume.

**C. Activity Address Code (Requisitioning DoDAAC)**

All requests for requisitioning DoDAACs will be submitted in accordance with chapters 4 and 5 of this Volume. All requests will identify the proper SABRS hierarchy for the new DoDAAC. An AAC cannot also be an MRI/ARI/SRI/WCI. See also figure 8-1 below and Appendix A of this Volume.

MRI	ARI	SRI	SCI	AAC	AUTH_CODE	ACTY_NAME	STREET1	STREET2	CITY	STATE
M39878	M39878	M39878	M49878	M39878	05	COMMANDING GENERAL	MARINE CORPS RECRUITING CMD	3280 RUSSELL ROAD	QUANTICO	VA
M39878	M39878	M39878	M49878	M49878	02	COMMANDING GENERAL	MARINE CORPS RECRUITING CMD	3280 RUSSELL ROAD	QUANTICO	VA
M39878	M39878	M39878	M49878	M5492	00	COMMANDING GENERAL	MARINE CORPS RECRUIT COMMAND	3280 RUSSELL RD	QUANTICO	VA
M39878	M67889	M67889	M47889	M67889	05	COMMANDING GENERAL	EASTERN RECRUITING REGION	PO BOX 19001	PARRIS ISLAND	SC
M39878	M67889	M67889	M47889	M47889	02	COMMANDING GENERAL	EASTERN RECRUITING REGION	PO BOX 19001	PARRIS ISLAND	SC
M39878	M67889	M67889	M47889	M10111	00	COMMANDING GENERAL	EASTERN RECRUIT REGION	PO BOX 19001	PARRIS ISLAND	SC
M39878	M67889	M67011	M47011	M67011	05	COMMANDING OFFICER	1ST MARINE CORPS DISTRICT, NY	605 STEWART AVE	GARDEN CITY	NY
M39878	M67889	M67011	M47011	M47011	02	COMMANDING OFFICER	1ST MARINE CORPS DISTRICT, NY	605 STEWART AVE	GARDEN CITY	NY
M39878	M67889	M67011	M47011	M80001	00	COMPTROLLER (SUPPLY)	HQ 1ST MARINE CORPS DISTRICT	605 STEWART AVE	GARDEN CITY	NY
M39878	M67889	M67011	M47011	M80012	00	COMPTROLLER (UTILITIES)	HQ 1ST MARINE CORPS DISTRICT	605 STEWART AVE	GARDEN CITY	NY
M39878	M67889	M67011	M47011	M80014	00	COMPTROLLER (MAINTANANCE)	HQ 1ST MARINE CORPS DISTRICT	605 STEWART AVE	GARDEN CITY	NY
M39878	M67889	M67011	M47011	M80204	00	COMPTROLLER (RS ENE)	HQ 1ST MARINE CORPS DISTRICT	605 STEWART AVENUE	GARDEN CITY	NY
M39878	M67889	M67011	M47011	M80741	00	COMMANDING OFFICER	US MARINE CORPS BUILDING 54	BAY 5 DDC	NEW CUMBERLAND	PA
M39878	M67889	M67011	M47011	M83900	00	COMPTROLLER (RS ALB)	HQ 1ST MARINE CORPS DISTRICT	605 STEWART AVENUE	GARDEN CITY	NY
M39878	M67889	M67011	M47011	M83902	00	COMPTROLLER (RS BUF)	HQ 1ST MARINE CORPS DISTRICT	605 STEWART AVENUE	GARDEN CITY	NY
M39878	M67889	M67011	M47011	M83903	00	COMPTROLLER (RS WNE)	HQ 1ST MARINE CORPS DISTRICT	605 STEWART AVENUE	GARDEN CITY	NY
M39878	M67889	M67011	M47011	M83904	00	COMPTROLLER (RS NYK)	HQ 1ST MARINE CORPS DISTRICT	605 STEWART AVE	GARDEN CITY	NY
M39878	M67889	M67011	M47011	M83925	00	COMPTROLLER (RS WPA)	HQ 1ST MARINE CORPS DISTRICT	605 STEWART AVENUE	GARDEN CITY	NY
M39878	M67889	M67011	M47011	M83966	00	COMPTROLLER (RS JER)	HQ 1ST MARINE CORPS DISTRICT	605 STEWART AVENUE	GARDEN CITY	NY

Figure 8-1. SABRS Table 208 Extract

**D. Navy DoDAAC**

Since all Navy DoDAACs are also Navy (financial) UICs, whenever a Marine Corps activity requires a Navy DoDAAC (e.g., aviation units), the procedures for a BCN/SRI above will be followed, except the Navy UIC/DoDAAC request will identify that *both* a UIC and DoDAAC are required. Once the UIC is created, DFAS will also then create a Navy DoDAAC and both will be identified back to DC I&L (LPC) who will then notify the requestor and other stakeholders impacted by the new UIC/DoDAAC.

080302. Total Force Structure Management System

In TFSMS, a UIC is used to identify requirements for personnel structure and equipment for permanent organizations established by a Marine Corps Bulletin 5400 (MCBul 5400). Within Marine Corps APSRs, DoDAACs are used to identify equipment sets that fill the T/E requirements of an activity's UIC. As such, every DoDAAC will be assigned to a UIC. The relationship between a TFSMS UIC and DoDAAC is one of "requirements" to "resources." In systems that consume both the TFSMS UIC and DoDAAC (e.g., GCSS-MC), the relationship can be likened to "owner" and "assets." The reason for this is because of how the DoDAAC is consumed by TFSMS. Within TFSMS, a DoDAAC is used to identify the property account ID that satisfies the requirements represented by the T/E of a UIC. Figure 8-2 illustrates this relationship between UIC and property account ID. It should be noted that DoDAACs are not only used as property account IDs in TFSMS. Some UICs in TFSMS do not have a T/E (e.g., Reserve I&I) but have a registered DoDAAC used as a "Ship To Only" DoDAAC that contains TAC 1 through TAC 4 mail/shipping information for the organization.

A. Wartime (Core) Mission

Maintaining the relationship between UIC and property account ID (DoDAAC) within TFSMS is the product of the DoDAAC update process. This relationship principally identifies the unit's core mission equipment requirements and the property account (DoDAAC) that satisfies these requirements. A unit's core mission structure is the TO&E resident in TFSMS. The DoDAAC is the ADS for the relationship between the UICs and DoDAACs. Per this guidance, all other systems shall consume this data directly from DoDAAF to ensure data integrity across the enterprise.

B. Assigned Mission/Deployments

Whenever a DoDAAC is required to enable business processes or account for equipment requirements in support of a task organization or unit executing an assigned mission different from their wartime (core) mission, the unit will either maintain the same DoDAAC, request an exercise DoDAAC, or request a contingency DoDAAC via the appropriate chain of command (MSC or MEF DoDAAC Monitor). Chapter 5 of this Volume provides detailed procedures for DoDAAC/UIC establishment and alignment in support of training exercises, contingencies, or unit rotations.

080303. Defense Readiness Reporting System – Marine Corps

A. Permanent units established by a MCBul 5400 and designated to report readiness in DRRS-MC will use a TFSMS-assigned UIC to capture the readiness of its wartime (core) mission requirements.

B. Provisional units (not resident in TFSMS), designated to report readiness in DRRS-MC will use a DC PP&O POR UIC. These units will use a manning document and EDL to capture the readiness of resources. DC PP&O POR shall notify DC I&L LP of the UIC; and DC I&L (LPC) will associate the deployment DoDAAC to this UIC in the DoDAAD.

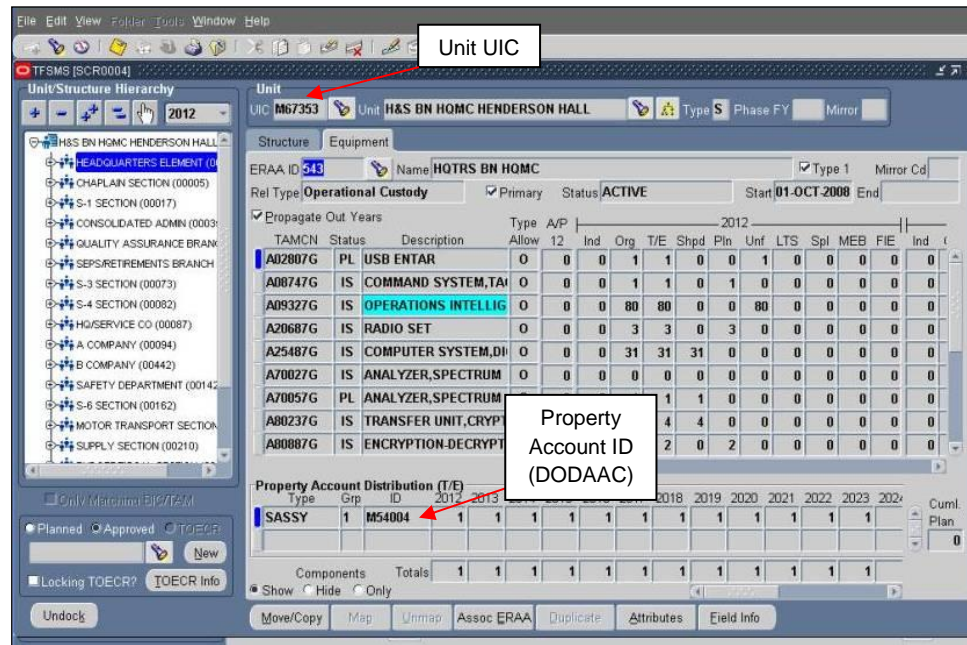

Figure 8-2.—TFSMS UIC and DoDAAC Relationship

**VOLUME 2: APPENDIX A**

**“APPROPRIATIONS, FUNDS, AND ACCOUNT CLASSIFICATION”**

**SUMMARY OF SUBSTANTIVE CHANGES**

Hyperlinks are denoted by ***bold, italic, blue and underlined font.***

The original publication date of this Marine Corps Order (MCO) Volume (right header) will not change unless/until a full revision of the MCO has been conducted.

All Volume changes denoted in **blue font** will reset to black font upon a full revision of this Volume.

CHAPTER VERSION	PAGE PARAGRAPH	SUMMARY OF SUBSTANTIVE CHANGES	DATE OF CHANGE

APPENDIX A

APPROPRIATIONS, FUNDS, AND ACCOUNTING CLASSIFICATION

1. Appropriations and Funds

To properly understand appropriation accounting, it is necessary to understand the difference between appropriations and funds.

a. Appropriations

An appropriation is an authorization by Congress to incur obligations for specified purposes and to make payments therefor from the Treasury. Simply stated, an appropriation is the result of an act of Congress to provide the funding authority for the Navy to accomplish specific functions or missions.

(1) Types of Appropriation Acts

To establish or amend an appropriation, Congress can pass three different types of appropriation acts: (1) regular, (2) supplemental, and (3) deficiency.

(a) Regular Appropriation Act

A regular appropriation act is the first appropriation act passed by Congress for a specific purpose for a particular fiscal year.

(b) Supplemental Appropriation Act

A supplemental appropriation act changes the monetary limitation, the purpose, or both, of an appropriation that is still available for obligation or for payment of existing obligations. A supplemental appropriation act may also be used to establish an appropriation that was not included in the regular appropriation act.

(c) Deficiency Appropriation Act

A deficiency appropriation act allows Congress to change the monetary limitation of a particular appropriation to permit the liquidation of known or anticipated obligations when the sums appropriated in the regular appropriation act are not sufficient to meet these obligations. Just as there are different acts by which appropriations can be established or amended, there are also different types of appropriations.

(2) Types of Appropriations

Although there are several types of appropriations, each type is designated by its own special term. The status of the appropriation is the determining factor. In the explanation of the following terms, notice how the status of the specific appropriation figures strongly in the definition of each term and actually establishes basic conditions under which the Navy must use that particular appropriation.

(a) Annual Appropriation

An annual appropriation is available for the incurring of obligations only in the fiscal year specified in the appropriation act. An annual appropriation is also referred to as a one-year appropriation.

(b) Multiple-year Appropriation

A multiple-year appropriation is available for the incurring of obligations for a definite period of time, but the period of time must exceed one fiscal year.

(c) Continuing Appropriation

A continuing appropriation is available for the incurring of obligations until the appropriation is exhausted or until the purpose for which the appropriation was made is accomplished. Also referred to as a no-year appropriation, a continuing appropriation has no fixed period of time.

(d) Current Appropriation

A current appropriation is available for the incurring of obligations only during the current fiscal year. This is also called an unexpired appropriation.

(e) Expired Appropriation

An expired appropriation is one that is no longer available for additional obligations, but it is still available for two years from the date of expiration for liquidation of any existing obligations.

(f) Definite Appropriation

A definite appropriation has the amount stated in the appropriation act as a specified sum of money.

(g) Indefinite Appropriation

An indefinite appropriation is one that does not have a specific amount stated in the appropriation act. Instead, the specific amount is determined at some future date from the sources specified in the appropriation act.

(h) Lapsed Appropriation

A lapsed appropriation is one that has an undisbursed balance, but by law is not available for disbursement.



(3) Types of Appropriation Accounts

Once an appropriation is passed, an appropriation account is established to make amounts available for expenditure and obligation from the Treasury. Appropriation accounts include not only accounts to which money is directly appropriated, but also revolving funds, working funds, and trust funds. (These funds will be discussed later.) There are three types of appropriation accounts: (1) open, (2) closed, and (3) successor.

(a) Open Appropriation Account

An open appropriation account is an account that has not had the balance transferred to a successor account or to surplus. The appropriation in the account may be expired or unexpired.

(b) Closed Appropriation Account

A closed appropriation account is an account that has had the balance transferred to a successor account or to surplus. The appropriation in the account is lapsed.

(c) Successor Account

A successor account is an account established for the payment of obligations applicable to appropriations for the same general purposes, but which have either lapsed or been discontinued. A successor account is available indefinitely for the payment of obligations chargeable to any of its predecessor accounts.

b. Funds

A fund, as used in connection with appropriations, is a sum of money or other resources, usually segregated, to be expended or used for specified purposes. Funds differ from appropriations in that they are usually permanent in nature and do not expire unless they are revoked by Congress. Three types of funds are commonly used by the Navy: (1) general, (2) trust, and (3) revolving.

(1) General Fund

The general fund of the Treasury is the fund into which all receipts of the United States Government are deposited, except for those from specific sources required by law to be deposited into other designated funds. Appropriations from the general fund are made by Congress to carry on the general and ordinary operations of the government.

(2) Trust Fund

A trust fund is used to deposit amounts received or appropriated and held in trust according to an agreement or a legislative act. These amounts may only be used or expended according to the terms of the trust or act. An example of a trust fund is Ship's Stores Profits, Navy. Profits from the ship's store are held in this account and may only be used for authorized expenses of the ship's store and the welfare and recreation of Navy personnel.

(3) Revolving Fund

A revolving fund is established to finance a cycle of operations to which reimbursements and collections are returned for reuse in such a manner as to maintain the principal of the fund. The amount of the fund may be in the form of cash, inventory, receivables, or other assets. An example of a revolving fund is the Navy Stock Fund, which is used to purchase and maintain stocks of common supply items required for the support and operation of the Navy.

2. Accounting Classification Code

In the Navy's financial management system, the accounting classification code provides a uniform system for accumulating and reporting a variety of accounting information. This code is shown on all purchase requests as well as the resulting obligation and expenditure documents. The accounting classification code identifies the activity responsible for accounting for the associated appropriation (or part of the appropriation). It also assists in the forwarding of copies of public voucher disbursements and elections to the accountable activity for analysis of obligations and expenditures. The detail required in a particular accounting classification code may vary, depending on the appropriation and type of transaction involved. An example of an accounting classification code that contains the maximum number of elements is shown in figure A-1. The figure also illustrates the order in which the accounting data should be entered on the required documents. The following sections will explain the significance of each of these elements and the order in which they should be used. The position and significance of the alphanumeric characters in each element will also be discussed.

a. Appropriation or Fund

In every accounting classification code, the first element represents the appropriation or fund. (Refer to number 1 on the left side of figure A-1. This represents the first element in the accounting classification code used as the example.) The appropriation or fund indicates the legal source of each transaction. In most cases, the appropriation code will consist of only seven alphanumeric characters. It may; however, contain up to nine characters, depending on the reporting requirements. The first two digits in the example are 1 and 7, or 17, which represents the Department of the Navy. The third digit, 8, is the last digit of the fiscal year for that particular annual appropriation. If the letter "X" is used in the third position instead of a number, then the appropriation is a continuing appropriation. If the letter "M" is used in the third position, then the appropriation is a successor appropriation. The next four digits (1453) indicate the type of appropriation. In the case of a fund, these four digits would indicate the type of appropriation and the particular type of fund used within that appropriation.

b. Subhead

The second element of the accounting code (indicated as number 2 on the left side of the figure) is the subhead. This element identifies the charges (or credits) to the appropriation or fund (indicated in element 1) for the particular transaction. The subhead consists of four characters. The first two characters identify the administering office. The last two characters identify the purpose of the subhead. For example, the subhead 2201 in figure A-1 identifies the administering office, 22, as the Bureau of Naval Personnel and the purpose, 01, as pay and allowances of officer personnel.

c. Object Class

The object class is the third element in the accounting classification code. (Refer to number 3 in figure A-1.) It consists of three digits. The object class designates the nature of the services, articles, or other items involved, as distinguished from the purpose for which obligations were incurred. There are four major categories of object classes:

- (1) personal services and benefits
- (2) contractual services and supplies
- (3) acquisition of capital assets
- (4) grants and fixed charges.

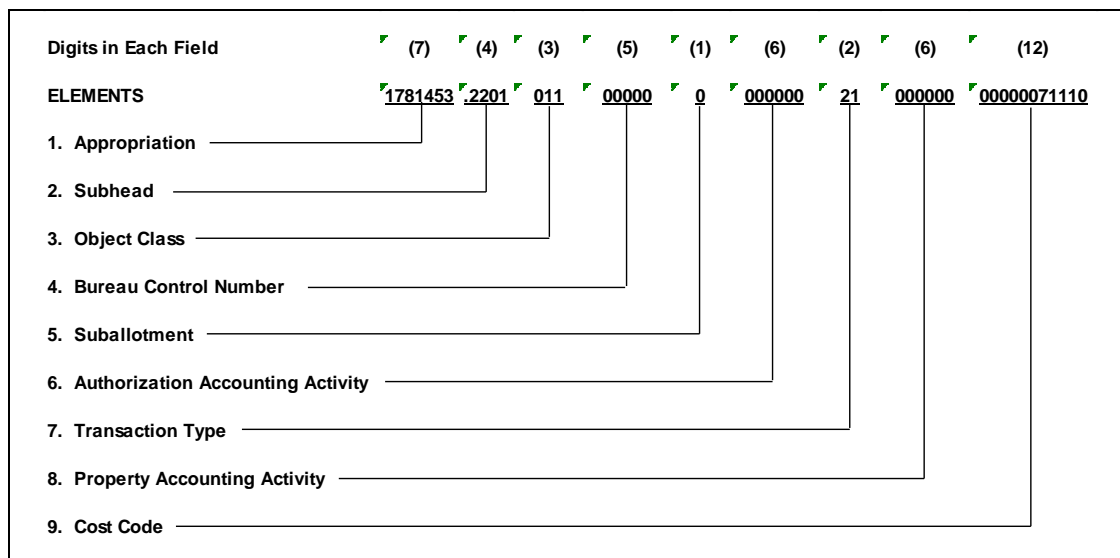

Figure A-1. The accounting classification code.

The Office of Management and Budget (OMB) directs the use of these classifications whenever the object class is required in the submitting of budget requests and reporting of data. The object class will appear as part of the accounting code required for obligations, costs, or disbursements.

d. Bureau Control Number

The fourth element in the accounting classification code is the BCN. As shown in figure A-1 (number 4), the BCN consists of five digits and represents the allotment authorization number. All funds within an appropriation account to be used for commitments, obligations, and expenditures are issued through allotments. An allotment is a subdivision of the appropriation that provides the funding authority for the accomplishment of a specific function or mission. The first two digits of the BCN designate the budget project; the next three digits constitute the serial number assigned to the allotment. In some cases, funds are not provided by an allotment. In these cases, the BCN is coded to identify other necessary accounting information.

e. Sub allotment

The sub allotment is the fifth element of the accounting classification code. (Refer to number 5 in figure A-1.) It further subdivides the allotment. The suballotment consists of one character that can be either alpha or numeric, as determined by the holder of the allotment.

f. Authorization Accounting Activity

As shown in figure A-1, the authorization accounting activity is the sixth element of the accounting classification code. It is composed of six digits and identifies the activity designated to perform allotment accounting and other accounting assignments. For this element, the UIC of the designated accounting activity is used. Since financial UICs only contain five digits, a zero prefix is added to make six digits. Notice that in the accounting data presented in figure A-1, the authorization accounting activity is not required. In cases such as these, six zeroes are used to fill the field.

g. Transaction Type

The seventh element represents the transaction type. Because most Navy accounting transactions are performed by machine, use of the two-digit alphanumeric transaction code allows for machine identification of the following categories:

- (1) Stores account purchases
- (2) Plant property account purchases
- (3) Other special suspense-type accounts
- (4) Formal and other special obligation accounting
- (5) Successor appropriations
- (6) Register and listing identification
- (7) Other transactions of special interest

In some cases, the functional account number (FAN) may serve the same purpose as the transaction type code.

h. Property Accounting Activity

The eighth element consists of the property accounting activity. As shown in figure A-1, this element consists of six digits. This six-digit element; however, can be constructed in several different ways, depending on the purpose of the expenditure. When the transaction code indicates a purchase for a stores account, the UIC of the activity designated to take the property into the stores account must be used. If the transaction code designates the purchase of plant property, the DoDAAC of the activity for which the plant property was purchased must be used.

i. Cost Code

The final element of the nine accounting classification code elements is the cost code. It is made up of 12 alphanumeric characters. The cost code provides additional information that may be needed for the preparation of detailed reports. The cost code is also used in reports that require shortened coding. The construction of the cost code is determined by the authorization accounting activity. Some items that often appear in cost codes are job order numbers, fund codes, FANs, and UICs.

3. Additional Accounting Components

The basic accounting classification code is made up of the nine elements discussed. In addition to the nine basic elements, there are other aspects or components of appropriation accounting classification code data. These important data items include allotments, FANs, UICs, and all financial transactions involving the international balance of payments (BOP).

a. Allotments

In the DON, an allotment is defined as an authorization granted, within and pursuant to an allocation or sub-allocation, to an office, command, activity, or component of the operating forces for the purpose of incurring commitments, obligations, and expenditures within a specified amount pursuant to the purpose for which the allotment was granted and according to instructions issued by the administering office. Simply stated, an allotment is a means by which available funds within an appropriation can be authorized, issued, and administered to the Navy so that they can be used to meet the financial obligations to support a specific function or mission. The granting of an allotment automatically reduces the available balance of the specific appropriation, but does not constitute a specific financial commitment or obligation on the part of Congress. Instead, the holder of the allotment becomes the authorized agent who may create commitments, obligations, and expenditures against the appropriation within the scope of the granted allotment. There are generally two types of allotments used in disbursing transactions: (1) regular and (2) centrally managed. They differ only in their individual limitations and accountability requirements.

(1) Regular Allotments

A regular allotment provides the normal operating budget for a command or activity. It is granted quarterly and is used for an activity's day-to-day operations. The commanding officer of the activity must closely monitor these funds to make certain they last through the entire quarter and their proper use and accountability can be readily demonstrated to the granting authority.

(2) Centrally Managed Allotments

A centrally managed allotment (CMA) is a formal administrative subdivision of funds (allocation or allotment) that is managed at the highest practical level and allows officials at a lower echelon to charge obligations or expenditures to the CMA for authorized purposes without further determination or certification of fund availability for individual transactions. Fund balances at the allocation/allotment level are subject to the provisions of reference (b). The same management internal control requirements apply for centrally-managed allotments as for regular allotments.

b. Functional Account Numbers

FANs classify transactions according to the use for which the transactions were made. They are used as reference numbers to determine the content of certain accounts used in various reports. The FANs themselves will often not be evident in the accounting classification code, but will appear as part of the cost code. In some cases, the FAN will be used in some other element, such as the BCN in permanent-change-of-station travel accounting data.

c. Unit Identification Codes

The UIC is a five-digit number that identifies an entity in the DON or DoD. Every command has a UIC. In fact, UICs are also assigned to civilian contractors and others who do business with DoD. Besides being used in the accounting classification code, UICs also appear in the Paid By section of public vouchers to aid in the identification of the disbursing officer of the agency making payments. UICs are also used in the Joint Uniform Military Pay System for such things as the distribution of leave and earnings statements and identification of the responsible paying offices for pay and allowances.

d. International Balance of Payments

The identification of financial transactions involving other countries is important to the United States Government. The economic well-being of the United States is directly influenced by the international BOP. The Comptroller of the Navy is responsible for coordinating and developing policies and procedures regarding foreign currency exchanges and other international financial transactions involving the Department of the Navy. The comptroller establishes procedures for the use of foreign currency in those countries in which the United States has Status of Forces Agreements, NATO Agreements, or Base Rights Agreements. Favored nation exchange rates for official transactions and for accommodation exchanges for United States personnel are sought by the comptroller as well. Any transaction that affects the international BOP must carry a two-character alpha code identifying the country involved in the transaction. An example is "CA" for Canada. Reference (c), contains the assigned country codes and the rules for applying them. As well as the

required country codes, you must also be aware of any applicable expenditure or collection category codes. In fact, any voucher that requires a country code must also have either a three-digit expenditure category code for disbursements or a two-digit source code for collections. These codes apply to transactions affecting disbursements and collections involving any appropriation, including all general, revolving, deposit, special, or trust funds, as well as any general fund receipt accounts established by the Treasury Department for collection or miscellaneous receipts.

**VOLUME 2: APPENDIX B**

**“DOCUMENT NUMBERS”**

**SUMMARY OF SUBSTANTIVE CHANGES**

Hyperlinks are denoted by ***bold, italic, blue and underlined font.***

The original publication date of this Marine Corps Order (MCO) Volume (right header) will not change unless/until a full revision of the MCO has been conducted.

All Volume changes denoted in **blue font** will reset to black font upon a full revision of this Volume.

CHAPTER VERSION	PAGE PARAGRAPH	SUMMARY OF SUBSTANTIVE CHANGES	DATE OF CHANGE



**APPENDIX B**

**DOCUMENT NUMBERS**

1. **Standard Document Number (SDN)**

The SDN is a 15-position document number used for all non-Interdepartmental Billing (IDB) requisitions. The example below shows the breakdown of an SDN:

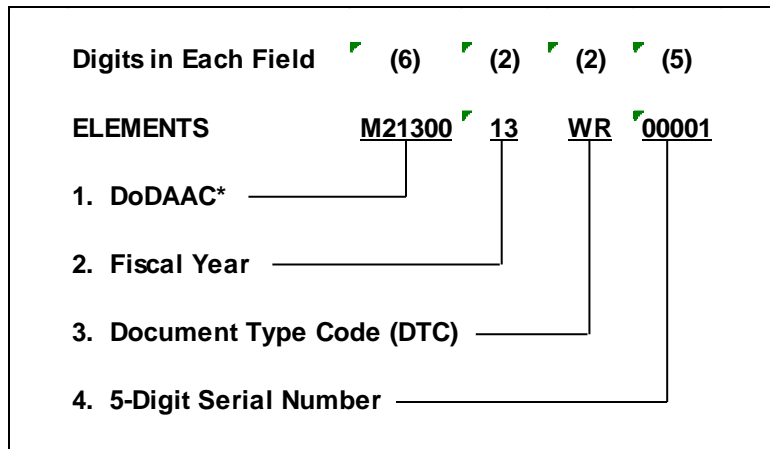

Figure B-1.—Standard Document Number.

**POSITION**      **CONTENT**

- 1-6              Requisitioning DoDAAC of the requesting/issuing activity.
- 7-8              Last two digits of the fiscal year in which the document was created.
- 9-10            Document Type Code (DTC) identifies the type of request being created to obtain goods or services.
- 11-15          5-digit Serial Number (See definition below.).

**NOTE:** The serial number is locally assigned to distinguish individual source documents. The serial number may be created using both alpha and numeric characters. Serial numbers assigned when creating SDNs cannot be repeated during the fiscal year for the same DoDAAC and Document Type Code. Resource managers will provide guidance on assigning SDN's, to include specific guidance on serial number assignments made by a fund manager. Further, resource managers will provide guidance on creating a document number log (i.e., spreadsheet, database, log book, etc.) to assist fund managers in maintaining control over the assignment of SDNs during the fiscal year to ensure SDNs are not assigned to more than one source document.

2. **MILSTRIP Document Number**

The 14-position MILSTRIP document number is assigned to requisitions processed through a government source of supply and for open purchase requisitions. The example below shows the breakdown of a MILSTRIP document number:

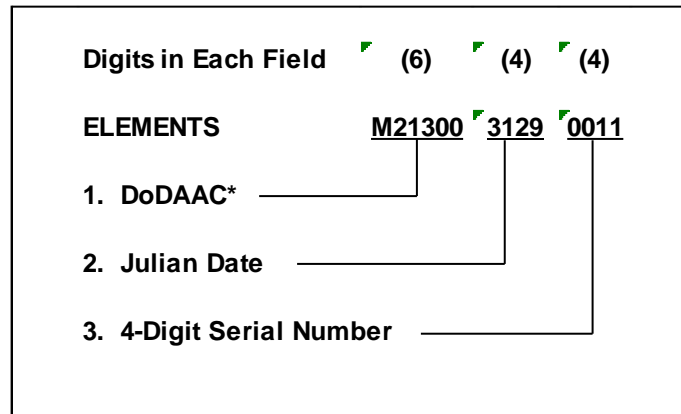

Figure B-2. MILSTRIP Document Number.

<u>POSITION</u>	<u>CONTENT</u>
-----------------	----------------

1-6	Requisitioning DoDAAC of the requesting/issuing activity.
7-10	Julian Date (See definition below.).
11-14	4-digit Serial Number, locally assigned to distinguish individual source documents.

NOTE: The Julian Date is composed of a one-digit calendar year (e.g., 1 represents calendar year 2001) followed by the current three-digit Julian Date (e.g., 001 represents 01 January, 365 represents 31 December except for leap year).

3. Procurement Instrument Identification Number (PIIN)

a. Per Federal Acquisition Regulations (FAR), the PIIN shall be used to identify all procurement documents (purchase orders, delivery orders, requests for quotation, etc.). The PIIN shall be used in its entirety by all Marine Corps contracting offices, purchasing offices, and commissaries. The construct of a PIIN includes use of a DoDAAC. The PIIN is a 13-position document number used by contract issuing activities to identify procurement actions. The PIIN is the proper document number to cite when recording obligations applicable to contracts. The Supplementary Procurement Instrument Identification (SPIIN) is a four-position document number and is the call or order number used for Blanket Purchase Agreements, Indefinite Delivery Contracts, and Basic Ordering Agreements.

b. Construction

The basic PIIN shall be retained for the life of the particular instrument and shall consist of 13 alpha-numeric characters. Major elements of the PIIN shall be separated by dashes. The example below shows the breakdown of a PIIN:

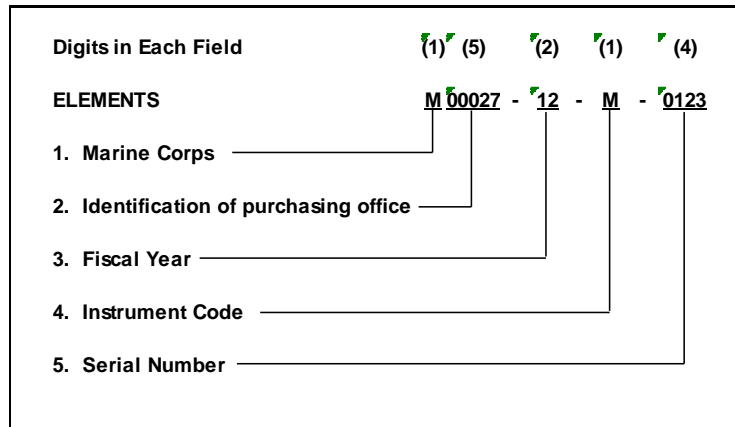

Figure B-3. Procurement Instrument Identification Number.

<u>POSITION</u>	<u>CONTENT</u>
1	The first position shall consist of the letter "M" for Marine Corps.
2-6	The second through sixth positions shall consist of the five-digit unit identification number assigned to the activity by the NavCompt Manual, Volume 2. Those activities having been assigned less than five-digit unit identification numbers shall place zeros before the number to fill the requirement for five digits.
7-8	The seventh and eighth positions shall be the last two digits of the fiscal year in which the PIIN is assigned.
9	The ninth position shall be a capital letter assigned to indicate the Type of Instrument Code, as follows: A = BPA's and board and lodging agreements. B = IFB. C = Contracts, except indefinite delivery-type. D = Indefinite delivery-type contracts. F = Delivery orders placed with or through other government departments or agencies or against contracts placed by such department or agencies; i.e., outside the DoD and including blind-made supplies.

<u>POSITION</u>	<u>CONTENT</u>
	G = Basic ordering agreement.
	L = Lease agreements (overseas only).
	M = Purchase order, manual (assigned W when numbering capability of M becomes exhausted during a fiscal year). Orders against DLA supply bulletins (commissary sales).
	P = Purchase order, automated (assign V when numbering capability of P becomes exhausted during a fiscal year).
	Q = Request for quotation, manual.
	R = Request for proposal.
	T = Request for quotation, automated (assign U when numbering capability of T becomes exhausted during a fiscal year).

- 10-13            The 10th through 13th positions shall be the serial number of the instrument. Separate series of serial numbers will be used as follows:
- A, F, M, and P may use the same serial number sequence.
  - C, D, and L may use the same sequence.
  - Q, R, and T may use the same sequence.
  - B must use a separate numbering sequence.

- 14-17            A SPIIN will be used when position 9 is coded A, G, or H and sometimes if position 9 is a D. The four positions will be alpha-numeric and will not contain the letters I and O or all zeros, spaces, dashes, or hyphens.

Note: Each series of PIINs for the same activity shall commence with the number 0001 at the start of each fiscal year. When more than 9,999 numbers are required, alpha-numeric numbers shall be assigned. (The letters I and O shall not be used.)

- c.            Supply bulletins which are issued by the DLA as part of the DoD are not numbered in PIIN format. Therefore, the use of alpha character "M" is the designation to be utilized for orders placed against DLA supply bulletins.

**VOLUME 2: APPENDIX C**

**“MAJOR COMMAND CODES”**

**SUMMARY OF SUBSTANTIVE CHANGES**

Hyperlinks are denoted by ***bold, italic, blue and underlined font.***

The original publication date of this Marine Corps Order (MCO) Volume (right header) will not change unless/until a full revision of the MCO has been conducted.

All Volume changes denoted in **blue font** will reset to black font upon a full revision of this Volume.

<b>CHAPTER VERSION</b>	<b>PAGE PARAGRAPH</b>	<b>SUMMARY OF SUBSTANTIVE CHANGES</b>	<b>DATE OF CHANGE</b>

APPENDIX C

MAJOR COMMAND CODES

USMC DODAAC MAJOR COMMAND CODES (MAJCOM)			
MAJCOM CODE	MAJOR COMMAND	POC	
B1	MCI EAST	MCI East	910 451 4893
B2	MCI WEST	MCI West G-4	760 725 9058
B3	MCI PAC	MCI Pac G-4	315 645 3017
C1	HQTRS USMC	I&L LPC	571 256 7123
C2	MCI COM	MCI Com G-4	703 695 6980
C3	MC RECRUITING COM	MCRC G-4	703 432 9222
C4	TRNG 7 ED COM	TECOM G-4	703 784 1169
C5	MARCORLOGCOM (Marine)	MCLC LOC	229 693 9391
	MARCORLOGCOM (Contractor)	MCLC MCA	229 693 5684
C6	MARCORSYSCOM	MCSC ALPS	703 432 3533
H1	MARFORCOM	MARFORCOM G-4	757 836 0756
H2	MARFORPAC	MARFORPAC G-4	808 477 8477
H3	MARSOC	MARSOC G-4	910 440 0744
H4	MARFOREUR	MARFOREUR G-4	314 431 2094
H5	MARFORSOUTH	MARFORSOUTH G-4	314 431 2094
H6	MARFORAF	MARFORAF G-4	305 437 2620
H7	MARCENT	MARCENT G-4	813 827 7016
H8	MARFORNORTH	MARFORNORTH G-4	504 697 8837
M1	I MEF	I MEF G-4	760 763 0647
M2	II MEF	II MEF G-4	910 451 9627
M3	III MEF	III MEF G-4	315 622 7243
M7	VII MEF (MEF FWD)	MARCENT G-4	813 827 7016
P1	MPS-1	BIC LogDiv	904 714 6255
P2	MPS-2	BIC LogDiv	904 714 6255
P3	MPS-3	BIC LogDiv	904 714 6255
PB	PREPO PGM BIC	BIC LogDiv	904 714 6255
PN	MCP P-N	BIC LogDiv	904 714 6255
R1	MARFORRES	MARFORRES G-4	504 697 8837

**VOLUME 2: APPENDIX D**

**“DODAAC AUTHORITY CODES”**

**SUMMARY OF SUBSTANTIVE CHANGES**

Hyperlinks are denoted by ***bold, italic, blue and underlined font.***

The original publication date of this Marine Corps Order (MCO) Volume (right header) will not change unless/until a full revision of the MCO has been conducted.

All Volume changes denoted in **blue font** will reset to black font upon a full revision of this Volume.

CHAPTER VERSION	PAGE PARAGRAPH	SUMMARY OF SUBSTANTIVE CHANGES	DATE OF CHANGE

**APPENDIX D**

**DODAAC AUTHORITY CODES**

1. Authority Code

The authority code is a two-digit code used to restrict requisitioning, shipment, and billing by DoDAAC. In March 2007, the DLMSO published an Approved DLMS Change to implement authority codes for DoDAACs, per reference (s). Reference (s) established these codes on behalf of OSD in order to restrict requisitioning, shipment, and billing by DoDAAC. This ADC further revised DLMS, MILSTRIP and MILSBILLS to identify DoDAAC authorities for requisitioning, shipment and billing, and to provide for DLA TS and source of supply rejection under DLMS, MILSTRIP and MILSBILLS of requisitions or bills, as appropriate. These authority codes are applicable to all service components of the DoD. Accordingly, there are eight authority codes which may be assigned to a DoDAAC. They are as follows:

CODE	DESCRIPTION	DEFINITION
0	Requisition	Full authority. Authorized to initiate a requisition/purchase for goods and services. Authorized ship-to and bill-to.
		Required: POC, TAC 1
		Business Rules: No restrictions
		DAAS DoDAAC Authority Code Edit: no additional edit
1	Ship-To Only	Can only be used as a ship-to address with no other implicit authority.
		Required: POC, TAC 1, (TAC 2 and/or TAC 4)
		Business Rules: Not authorized to requisition or bill-to
		DAAS DoDAAC Authority Code Edit: DoDAAC may only be used in
2	Finance (Bill-To Only)	DoDAAC can only be used as a bill-to
		Required: POC, TAC 1, TAC 3
		Business Rules: Cannot requisition, can not be used as a ship-to designation
		DAAS DoDAAC Authority Code Edit: DoDAAC may only be used in the
3	Do Not Ship-To	Cannot be used as a ship-to destination
		Required: POC, TAC 1
		Restriction: TAC 2 and TAC 4 are not allowed
		Business Rules: Can not be used as a ship-to designation
4	DDS Only	DLA Disposition Services (DDS) (e.g., State agencies surplus). Used to identify activities who have no requisition authority other
		Required: POC, TAC 1
		Business Rules: Cannot requisition new material. Only authorized to obtain materials from DDS (DoD excess only).
		DAAS DoDAAC Authority Code Edit: DoDAAC may only be used with DDS RIC (S9D) in record positions 4-6
5	Non-Requisition	Cannot initiate a purchase or request for goods and services
		Required: POC, TAC 1
		Business Rules: Cannot requisition/purchase any good/services.
		DAAS DoDAAC Authority Code Edit: DoDAAC cannot be used in requisition in the requisitioner field ( record positions 30-35).
6	Free Issue	No cost option. This activity is restricted to items that are available without cost (e.g., DDS, NGA Maps)
		Required: POC, TAC 1
		Business Rules: Cannot requisition/purchase any good/services. Similar to DDS, but can request free of cost items (e.g., DDS, NGA maps)
		DAAS DoDAAC Authority Code Edit: DoDAAC may only be used with signal code D or M
7	Administrative	Administrative only. This code is used for information/identification purposes only (e.g., Defense Courier Service, or for future DoDAAC activation, such as in the case of DoDAACs reserved for contingencies (at which time a different Authority Code may be assigned.))
		Required: POC, TAC 1
		Business Rules: Cannot requisition, can not be used as a ship-to designation, and can not be used for billing. Information/identification use only.
		DAAS DoDAAC Authority Code Edit: DoDAAC may not be used in a requisition in record positions 30-35 or in record positions 45-50 as a "ship to" or "bill to"

Figure D-1. DoDAAC Authority Codes



2. Internal USMC Business Rules

As the Marine Corps implements authority codes, application of these codes to our systems must be closely managed in order to meet the intent of these codes as prescribed by OSD. Accordingly, the following business rules apply for Marine Corps use of DoDAAC authority codes:

a. Authority Code 00 – Full or Requisition Authority

Authority Code 00, the most controversial of authority codes, designates full authority which is also referred to as requisition authority. Requisition authority is that authority vested in someone to obligate appropriations. Before the advent of a mechanized supply system (i.e., SASSY), expenditure of appropriated dollars started with the creation of a document number in a log book usually maintained by a supply officer. That document number had unit identification and financial information associated to it that enabled the obligation of appropriated dollars. The owner of that document number was accountable and liable for the obligation of appropriated dollars created by the processing of that document number. The authority to create this obligation is requisition authority. Requisition authority is defined by existing statute and policy, per reference [\(m\)](#) as follows:

(1) United States Code

Title 31 is the foundation in defining requisition authority, as it legally requires that there be traceability (and liability) to an individual for the over-obligation of appropriated funds as a violation of the Anti-Deficiency Act. Specifically, the following sections apply:

(a) Section 1301

Appropriations shall be used only for the purpose for which the appropriations were made, except as otherwise provided by law.

(b) Section 1341

An officer may not make or authorize an expenditure or obligation exceeding an amount available in an appropriation or fund for the expenditure or obligation.

(c) Section 1349

An officer or employee of the United States Government or of the District of Columbia government violating section 1341 (a) or 1342 of this title shall be subject to appropriate administrative discipline including, when circumstances warrant, suspension from duty without pay or removal from office.

(d) Section 1350

An officer or employee of the United States Government or of the District of Columbia government who knowingly and willfully violates section 1341 (a) or 1342 of this Title shall be fined not more than \$5,000, imprisoned for not more than 2 years, or both.

(e) Section 1511

An appropriation means appropriated amounts, funds, and authority to make obligations by contract before appropriations.

(f) Section 1514

The official having administrative control of an appropriation shall prescribe a system of administrative control which can restrict obligations or expenditures from each appropriation to the amount of apportionments or reapportionments of the appropriation, and enable the official to fix responsibility for an obligation or expenditure exceeding an apportionment or reapportionment. The system shall also be able to administratively divide appropriations with the objective of financing each operating unit, at the *highest* practical level, from not more than one administrative division for each appropriation affecting the unit.

(g) Section 1517

An officer shall not make or authorize an expenditure, or obligation exceeding an apportionment; or the amount otherwise permitted by regulations.

(h) Section 1518

An officer violating section 1517 shall be subject to appropriate administrative discipline including, when circumstances warrant, suspension from duty without pay or removal from office.

(i) Section 1519

An officer who knowingly and willfully violates section 1517 of this Title shall be fined not more than \$5,000, imprisoned for not more than 2 years, or both.

(2) The Marine Corps Manual

Per reference [\(m\)](#), CMC appoints subordinate commanders to execute the mission of the Marine Corps. Inherent in this appointment is the authority to carry out a number of responsibilities. The Marine Corps Manual provides the following guidance as it relates to commanders and their responsibilities.

(a) Commander

One who is properly appointed to command an organization, or who under applicable provisions of law, regulations, or orders, succeeds to such command due to transfer, incapacity, death, or absence of the previous Commanding Officer (CO). Marine Corps commanders are titled as Commandant, Commander, Commanding General, CO, Director, and Inspector-Instructor. Other titles used to designate Marine Corps commanders shall be made only with the specific approval of the CMC. The titles Officer in Charge (OIC) or Noncommissioned Officer in Charge do not normally denote a commander; however, in specific instances, superiors in the chain

of command may delegate command authority to OICs or Noncommissioned Officers in Charge to the extent required for them to carry out their assigned tasks.

(b) The management of finances is inherent to command.

(c) The commander is responsible for the administration of all authorizations of funds formally granted through an operating budget or allotment. This responsibility *cannot be delegated* in whole or part within the command. Accordingly, COs are personally responsible for any act of their own, or an act of a subordinate, which causes an over-commitment, over-obligation, or over-expenditure of an authorization of funds and may be subjected to the penalties as set forth in Chapters 13 (Appropriations) and Chapter 15 (Appropriation Accounting) formally Section 3679 Revised Statutes and Section 665 of reference [\(b\)](#).

(3) Accountable Officer

Another critical criterion of requisition authority is a commander's role as an accountable officer as it relates to equipment accountability. A commander's role as an accountable officer is tied to Title 10 responsibilities relative to equipment accountability. Per reference [\(m\)](#), the criteria for an accountable officer are also tied to succession to command. The following are germane:

(a) United States Code (U.S.C.) Title 10

The foundation for a commander's responsibilities relative to the accountability of equipment and property charged to them is found in Title 10 of U.S.C. Subtitle A, Part IV provides this framework in two chapters as follows.

1. Chapter 161, Section 2721

Under regulations prescribed by him, the Secretary of Defense shall have the records of the fixed property, installations, major equipment items, and stored supplies of the military departments maintained on both a quantitative and a monetary basis, so far as practicable. The regulations prescribed pursuant to this subsection shall include a requirement that the records maintained under such subsection (1) to the extent practicable, provide up-to-date information on all items in the inventory of DoD; (2) indicate whether the inventory of each item is sufficient or excessive in relation to the needs of the Department for that item; and (3) permit the Secretary of Defense to include in the budget submitted to Congress under section 1105 of reference [\(b\)](#) for each fiscal year, information relating to the amounts proposed for each appropriation account in such budget for inventory purchases of DoD, and the amounts obligated for such inventory purchases out of the corresponding appropriations account for the preceding fiscal year.

2. Chapter 165, Section 2788

The Secretary of a military department may prescribe regulations for the accounting for the property of that department and the fixing of responsibility for that property.

(b) The Marine Corps Consumer Level Supply Policy Manual

Accountability is inherent to command and the CO of a unit having a consumer-level supply account is accountable by virtue of acceptance of command.

(c) Succession to Command

Reference [\(m\)](#), Chapter 1, paragraph 1007.2 establishes the policy for succession to command. Not every CO, however, can be an accountable officer. Whoever lawfully succeeds to command must also possess the requisite legal authority necessary to discharge accountable officer legal responsibilities. The reference [\(t\)](#) states that the authority to convene courts-martial is independent of rank and is retained as long as the convening authority remains a commander in one of the designated positions (Rule 504, Convening courts-martial, and page II-48, MCM.) These designated positions are defined in the Uniform Code of Military Justice.

1. General Court-Martial

Article 22 describes the authority to convene a general court-martial as the CO of a division, a separate brigade, or a corresponding unit of the Marine Corps, or the CO of a wing of the Marine Corps.

2. Special Court-Martial

Article 23 describes the authority to convene a special court-martial as the CO of any Marine brigade, regiment, detached battalion, or corresponding unit; the CO of any Marine barracks, wing, group, separate squadron, station, base, auxiliary air field, or other place where members of the Marine Corps are on duty.

3. Summary Court-Martial

Article 24 describes the authority to convene a summary court-martial. When only one commissioned officer is present with a command or detachment he shall be the summary court-martial of that command or detachment and shall hear and determine all summary court-martial cases brought before him. Summary courts-martial may, however, be convened in any case by superior competent authority when considered desirable by him.

4. Article 15

The lowest level of authority necessary to effectively adjudicate matters relative to the role of an accountable officer is tied to whoever may impose nonjudicial punishment. Article 15 establishes that the following persons may serve as a nonjudicial punishment authority for the purposes of administering nonjudicial punishment proceedings:

a. Commander

As provided by regulations of the Secretary concerned, a commander may impose nonjudicial punishment upon any military personnel of that command. “Commander” means a commissioned or warrant officer who, by virtue of rank and assignment, exercises primary command authority over a military organization or prescribed territorial area, which under pertinent official directives is recognized as a “command.” “Commander” includes a commander of a joint command. Subject to subparagraph 1d(2) of the reference (t) and any regulations of the Secretary concerned, the authority of a commander to impose nonjudicial punishment as to certain types of offenses, certain categories of persons, or in specific cases, or to impose certain types of punishment, may be limited or withheld by a superior commander or by the Secretary concerned.

b. OIC

If authorized by regulations of the Secretary concerned, an OIC may impose nonjudicial punishment upon enlisted persons assigned to that unit.

c. Principal Assistant

If authorized by regulations of the Secretary concerned, a commander exercising general court-martial jurisdiction or an officer of general or flag rank in command may delegate that commander’s powers under Article 15 to a principal assistant. The Secretary concerned may define “principal assistant.”

5. Punishments

The final piece in determining the lowest level of authority necessary to fulfill accountable officer responsibilities is linked to the maximum level of punishment authorized for nonjudicial punishment proceedings. Per reference (t), the Secretary concerned may limit the power granted by Article 15 with respect to the kind and amount of the punishment authorized. The maximum punishment that may be authorized from nonjudicial punishment proceedings is dependent upon both the accused and the presiding authority of the proceedings.

a. If the accused is a commissioned or warrant officer, the presiding authority must be a CO over the accused, or an officer exercising general court-martial jurisdiction, an officer of general or flag rank in command, or a principal assistant as defined in paragraph 2c, Part V of reference (t).

b. If the accused is any other military personnel of the command, the level of authority necessary to impose the broadest scope of punishment rests with COs of the grade of major or lieutenant commander or above, or a principal assistant as defined in paragraph 2c of Part V of the reference (t).

(4) Criteria

To be appointed with requisition authority, it is not enough that someone is able to obligate appropriations. There must also be a mechanism in place whereby the goods/services for which these obligations were made are tracked in a lifecycle management process (i.e., generation of requirement all the way through to disposal). By law, someone has to be held accountable for the obligation of appropriated funds (more specifically, the over-obligation of funds). Similarly, this person has the responsibility to physically account for the supplies and equipment that are bought with appropriated funds. This mission is delegated down by the CMC to COs through the issuance of orders and through TO&E over which someone is appointed as the accountable officer. The distinction on who can serve as an accountable officer hinges upon court-martial and non-judicial punishment authority, because the accountable officer needs to be able to adjudicate matters relative to any loss, damage, or theft of government property over which he/she is charged. The proper definition for requisition authority must include all the tenets of these statutes and regulations; therefore, the following criterion qualifies possession of requisition authority for a commander and the command/activity:

(a) The command/activity must have an authorized mission (by approved mission statement in the T/O) to requisition supplies, equipment, materiel, and or services.

(b) The command/activity must have an authorized mission (by approved mission statement in the T/O) to possess financial management capability (resources and allocated funds) that enable requisitioning.

(c) The command/activity must have an authorized mission (by approved mission statement in the T/O) to possess supply accountability capability (personnel and resources to account for and track supplies and equipment through its life cycle from initial request to retirement/disposal) for requisitions and requisitioned items.

(d) The command/activity must have requisite training staff (S-3) to ensure that people charged with responsibility to execute accountability are properly trained in their respective Training and Readiness tasks.

(e) The command/activity must have requisite logistics staff (S-4) to coordinate logistics business processes on behalf of the command (i.e., armory, ammunition, etc.).

(f) The person appointed to command this activity must be officially appointed to the office of commander by orders issued by the CMC.

(g) This person must fulfill the duties of an accountable officer for purposes of exercising Title 10 responsibilities relative to equipment accountability.

(h) This person must possess sufficient level of judicial authority (courts-martial & non-judicial punishment) to adjudicate matters relative to the disposition of accountable supplies and equipment (field grade or above).

(5) Definition. According to reference (b), liability and accountability for the obligation of apportionments (appropriated funds) must be traceable to an individual. The CMC is responsible for the obligation of appropriated funds provided to the Marine Corps. The Commandant confers this requisition authority upon COs above the company grade, as defined by reference (m), who may in turn delegate an appointee (e.g., supply officer) to carry out this function. Requisition authority is inherent to commands/activities with the T/O mission to submit and process/manage financial transactions to fill requirements, and to manage both the fiscal and supply responsibilities inherent to the full life cycle of the transactions (e.g., from creation of a request through to closing/retirement/disposal) and the goods/services procured by them (i.e., maintaining formal equipment accountability, sub custody, and requisitioning records, etc.). Commands charged with this mission must therefore possess the T/O supply and fiscal structure necessary to perform all of these functions. A supply officer or civilian equivalent with appropriate supporting supply staff are authorized to submit requisitions on behalf of these commands to obligate appropriated funds, unless stated otherwise in the most current MCBul 5400 or mission statement. The following command-level tasks require requisition authority, as delegated by the commander: supply operations, purchasing, acquisition, creation of orders for temporary additional duty (TAD), and labor (to include time keeping). Commands with requisition authority are assigned an authority code of “00” for their DoDAAC in the DoDAAD. For the purposes of this policy, requisition authority is defined as a DoDAAC activity whose commander has the authority and capability to commit financial obligations of appropriated funds (e.g., COs who have supply officers). DoDAACs with an authority code of “00,” must have the appointed APO/ supply officer listed as the POC for that respective DoDAAC in the DoDAAD.

b. Authority Code 01 – Ship-To Authority

Authority code “01” designates that the unit/activity identified by the DoDAAC is authorized to receive shipments only, but cannot requisition. It also implies that the activity has the requisite capability in trained personnel to do proper receipt and acceptance of materials shipped to it.

c. Authority Code 02 – Bill-To Authority

Authority code “02” designates that the unit/activity identified by the DoDAAC is authorized to be billed or to pass funding. In the Marine Corps, this authority code is used only for WCIs in SABRS, as identified in Figure A-2.

d. Authority Code 03 – Cannot Ship-To Authority

Authority code “03” designates that the unit/activity identified by the DoDAAC cannot receive shipments. This authority code is not currently used in the Marine Corps.

e. Authority Code 04 – DDS Authority

Authority code “04” designates that the unit/activity identified by the DoDAAC is authorized to obtain materiel from DLA Disposition Services, formerly known as DRMO. DoDAACs with authority code “04” cannot requisition new materiel. This authority code is not currently in use by the Marine Corps.



f. Authority Code 05 – Non-requisition Authority

Authority code “05” designates that the unit/activity identified by the DoDAAC cannot purchase any goods/services. In the Marine Corps, this authority code is used only for SRIs in SABRS, as identified in Figure A-2.

g. Authority Code 06 – Free Issue Authority

Authority code “06” designates that the unit/activity identified by the DoDAAC is authorized to requisition items that are available without any cost. This unit/activity cannot requisition/purchase goods and services that incur a cost to the government. Examples include maps and flight publications available from DLA through Account Management and Provisioning System (AMPS)/(Mapping Enterprise Business System) MEBS. Ammunition Supply Point (ASP) DoDAACs that requisition Class V(W) for resupply are assigned authority code “06,” since the ammunition has already been “purchased” by the Inventory Control Point (ICP) of the Marine Corps. These transactions, therefore, do not incur a cost.

SABRS DODAAC Authority Code Assignment					
Level	Title	Authority Code	Business Rules	EXAMPLES	
<b>MRI</b>	Major Recipient ID	05	- Cannot be the same as a WCI or DODAAC. - Labor/Pay (DCPS/MCTFS). - Authorization DICs that need to acknowledge 05 are: IAA, DAA, AL1, AL3, DEX, FRA, ADG, ARI, and all others but those listed for authority code 02. - Funds distribution to the WCI level.	M67025	MARFORPAC
<b>ARI</b>	Allotment Recipient ID			M67025	MARFORPAC
<b>SRI</b>	Sub-allotment Recipient ID			M68450	IMEF
<b>WCI</b>	Work Center ID	02	- A WCI can NOT be a BCN and therefore A WCI can NOT be a SRI - A WCI can NOT be used in DTS, SAB1TRVL, MCPDT MROWS or for "manual" spending transactions. - Authorization DICs that need to acknowledge Authority Code 02 are: AL5, OT1, OT2, & OTX, FRA and ADG - DTC=TO/CT/CS (all "travel" both civilian and military) can NOT be a WCI - Funds distribution to the BEA and BESA level is by WCI only	M57081	3D MAW
<b>AAC</b>	Activity Address Code (Execution)	00	- An AAC that has authority code=00 can NOT be a WCI - DTC=TO/CT/CS (all "travel" both civilian and military) - All other execution - Document Numbers can only be created and submitted on Requests/Demands using the AAC (Requisitioning DoDAAC) of the command/activity, by personnel who have been delegated (in writing) by the commander of that command/activity, on a signed delegation of authority/duties letter (DD 577). - Activities who do not have an AAC in SABRS, yet receive funding, and are thus supported by a command/activity with the capability/authorization to requisition on their behalf, must use the appropriate transfer document (i.e., MIPR-DD448, Work Request-NC2275/NC2276 or Inter-Fund w/Signal Code) so the bill can be sent to the supporting activity, or they can use the direct cite in lieu of Marine Corps to Marine Corps reimbursables.	M00039	MAG-39

Figure A-2. SABRS DoDAAC Authority Codes

h. Authority Code 07 – Administrative Authority

Authority code “07” designates that the unit/activity identified by the DoDAAC is purely an administrative record. DoDAACs with this authority code cannot perform any business processes. In the Marine Corps, this authority code is generally used by the CSP at DC I&L for management purposes usually leading to a decision to delete a DoDAAC no longer required.



**VOLUME 2: APPENDIX E**

**“USMC DODAAC ASSIGNMENT LOGIC”**

**SUMMARY OF SUBSTANTIVE CHANGES**

Hyperlinks are denoted by *bold, italic, blue and underlined font*.

The original publication date of this Marine Corps Order (MCO) Volume (right header) will not change unless/until a full revision of the MCO has been conducted.

All Volume changes denoted in *blue font* will reset to black font upon a full revision of this Volume.

CHAPTER VERSION	PAGE PARAGRAPH	SUMMARY OF SUBSTANTIVE CHANGES	DATE OF CHANGE

**APPENDIX E**

**USMC DODAAC ASSIGNMENT LOGIC**

<b>Component DoDAAC Assignment Logic</b>			
<b>Marine Corps: L, M</b>			
<b>Position</b>	<b>Code</b>	<b>Description</b>	
<b>1</b>	<b>L</b>	All Marine Corps Contractors	
	<b>M</b>	Marine Corps units/activities	
The following additional positions are used for M DODAACs; however, there are exceptions to each general rule:			
<b>2</b>	<b>0</b>	Aviation Combat Element (ACE) units/activities	
	<b>1</b>	Ground Combat Element (GCE) units/activities	
	<b>2</b>	Logistics Combat Element (LCE) units/activities	
	<b>3</b>	Supporting Establishment (SE) units/activities (bases and stations)	
	<b>4</b>	HQMC Programs & Resources (P&R) use and Training and Education Command (TECOM) units/activities	
	<b>5</b>	HQMC use and Marine Corps Logistics Command units/activities	
	<b>6</b>	DFAS/HQMC Programs & Resources (P&R) use	
	<b>7</b>	HQMC and Marine Forces Reserve units/activities	
	<b>8</b>	Marine Corps Recruiting Command use	
	<b>9</b>	HQMC use, Marine Forces (deployed), and Marine Corps Logistics Command use	
	<b>M</b>	Assigned in coordination with Marine Corps Logistics Command (LCC) to establish Intermediate-level Supply Activities (i.e., SMU Gen Acct, etc.), and accounts for exercises. The following are general conventions, but exceptions exist.	
			MMAXxx = Albany account
			MMB = Barstow account
			MMC = Camp Pendleton account
			MMF = Maintenance Float (Reparable Issue Point) Accounts
			MMG = Subfloat accounts for I MEF (no longer assigned using this convention).
			MMH/J = Miscellaneous Intermediate-level accounts or deployed account.
			MMK = Hawaii account
			MML = Camp Lejeune account
			MMM/N = MarForRes account
			MMP = Camp Lejeune, Base account
			MMQ = Quantico account
			MMR = Okinawa account
			MMS = MARSOC & Miscellaneous accounts
			MMT = MCAGCC 29 Palms account
			MMV = Blount Island account
			MMW = Parris Island account
			MMX = Various intermediate-level accounts, generally used for MCCA, SE, and deployed contingency operational support accounts.
			MMY = Yuma account
		<b>N - P</b>	Various; Detachments, Dept of State, etc.
		<b>S</b>	Maintenance Float Sub-accounts (a.k.a. Sub Float Accounts)
		<b>T</b>	Class II accounts
		<b>W</b>	Messhalls & Food Service
	<b>X</b>	Marine Forces in support of Unified Commands; Contingency DoDAACs: used for creating task-organized, deployed accounts in support of Overseas Contingency Operations (OCO).	
		MX0xxx = USPACOM (MARFORPACOM)	
		MX1xxx = USNORTHCOM (MARFORNORTHCOM)	
		MX2xxx = USSOUTHCOM (MARFORSOUTHCOM)	
		MX3xxx = USAFRICOM (MARFORAFRICOM)	
		MX4xxx = USCENTCOM (MARFORCENTCOM)	
		MX5xxx = USEUCOM (MARFOREUCOM)	
		MX6 - MX9 = Reserved for future use	
	<b>Y - Z</b>	Reserved for expansion	

**VOLUME 2: APPENDIX F**

**“USMC DODAAC REQUEST (NAVMC 11718)**

**SUMMARY OF SUBSTANTIVE CHANGES**

Hyperlinks are denoted by ***bold, italic, blue and underlined font.***

The original publication date of this Marine Corps Order (MCO) Volume (right header) will not change unless/until a full revision of the MCO has been conducted.

All Volume changes denoted in **blue font** will reset to black font upon a full revision of this Volume.

CHAPTER VERSION	PAGE PARAGRAPH	SUMMARY OF SUBSTANTIVE CHANGES	DATE OF CHANGE

**APPENDIX F**

**NAVMC 11718 "USMC DODAAC / RIC REQUEST"**

<b>NAVMC 11718 (Rev. 12-2014) (EF)</b>		<input type="button" value="Print Form"/>
FOUO - Privacy sensitive when filled in.		
<b>USMC DODAAC / RIC REQUEST</b> <small>(Read Additional Instructions, Authority Codes, and Major Command Codes before completing form.)</small>		
To request changes to the Department of Defense Activity Address Directory (DoDAAD), complete this form by entering data in the shaded areas and forward to the U.S. Marine Corps DoDAAD Central Service Point (CSP) – via the appropriate MAJCOM DoDAAC Monitor(s) – along with a copy of the MCBul 5400 (as applicable). The CSP can be reached at USMCD00AAACMGR@usmc.mil. NOTE: All fields are mandatory. Enter information in shaded areas.		
<b>SECTION I - TYPE OF REQUEST</b> <small>(Check One)</small>		
DEPARTMENT OF DEFENSE ACTIVITY ADDRESS CODE (DoDAAC)		
<input type="checkbox"/> A. NEW DoDAAC <small>(Enter DoDAAC being requested (from MCBul 5400 as applicable).)</small>		
<input type="checkbox"/> B. DELETE <small>(Enter DoDAAC being deleted.)</small>		
C. <input type="checkbox"/> UPDATE <input type="checkbox"/> CHANGE <small>(Enter DoDAAC being updated/changed.)</small>		
D. UNIT ROTATION (NOTE: If this DoDAAC Update is for a Unit Rotation, enter the DoDAAC of the other unit(s) involved here):		
<small>(Enter Secondary MAJCOM)</small>	<input type="text"/>	<small>(Enter Secondary DoDAAC)</small>
<small>(Enter Tertiary MAJCOM)</small>	<input type="text"/>	<small>(Enter Tertiary DoDAAC)</small>
ROUTING IDENTIFICATION CODE (RIC)		
<input type="checkbox"/> E. NEW RIC <small>(Enter DoDAAC to which this RIC will be associated and fill out TAC 1 information below.)</small>		
F. <input type="checkbox"/> UPDATE <input type="checkbox"/> CHANGE <input type="checkbox"/> DELETE <small>(Enter RIC.)</small>		<small>(Enter DoDAAC to which this RIC will be associated.)</small>
G. REASON FOR REQUEST: <small>(Provide a brief description why this request is being submitted. If new DoDAAC, ensure reason justifies Authority Code requested.)</small>		
<b>SECTION II - DoDAAC IDENTITY INFORMATION</b>		
1. UNIT IDENTIFICATION CODE (UIC): <small>(Enter the Unit's UIC of this DoDAAC from either TFSMS or DRRS-MC.)</small>		4. PROCUREMENT AUTHORITY FLAG: <small>(Enter Y ONLY if authorized by HQMC LB to write contracts against this DoDAAC.)</small>
2. MAJOR COMMAND (MAJCOM) CODE: <small>(Enter MAJCOM.)</small>		5. STATUS COMM: <small>(Enter COMM.)</small>
3. AUTHORITY CODE: <small>(Enter requested Authority Code. 00, 02, &amp; 06 require Commander's approval.)</small>		6. BILLING COMM: <small>(Enter COMM.)</small>
<b>SECTION III - STANDARD ACCOUNTING, BUDGET AND REPORTING SYSTEM (SABRS) HIERARCHY</b> <small>(Enter the Hierarchy for this DoDAAC that will be loaded to Table 206 in SABRS.)</small>		
7. MAJOR COMMAND RECIPIENT IDENTIFIER (MRI):		
8. ALLOTMENT RECIPIENT IDENTIFIER (ARI): <small>(Enter ARI if this request is for a DoDAAC that will be used as a SRI, WCI, or AAC.)</small>		
9. SUBALLOTMENT RECIPIENT IDENTIFIER (SRI): <small>(Enter SRI if this request is for a DoDAAC that will be used as a WCI or AAC.)</small>		
10. WORK CENTER IDENTIFIER (WCI): <small>(Enter WCI if this request is for a DoDAAC that will be used as an AAC.)</small>		
<b>SECTION IV - TAC 1 INFORMATION</b>		
11. LINE 1: <small>(Enter first line of Unit's official mailing address; normally unit/activity commander's title.)</small>		
12. LINE 2: <small>(Enter second line of Unit's official mailing address; normally name of the unit/activity.)</small>		
13. LINE 3: <small>(Enter third line of Unit's official mailing address; normally the street address or Post Office Box of the unit/activity.)</small>		
14. LINE 4: <small>(Enter fourth line of Unit's official mailing address in the following fields.)</small>		
14A. COUNTRY (--mil-, fip-, fms-)	14B. STATE/PROVINCE:	
14C. CITY:	14D. ZIP CODE:	14E. INTERNATIONAL ZIP CODE:
15. LINE 5 (RESERVED FOR DLA USE ONLY.)		

**FOR OFFICIAL USE ONLY**

Adobe LiveCycle Designer 9









NAVMC 11718 (Rev. 12-2014) (EF) Page 2  
 FOUO - Privacy sensitive when filled in.

SECTION V - TAC 2 INFORMATION		
16. LINE 1: (Enter first line of the Unit's official shipping address; normally the supporting DMO/TMO.)		
17. LINE 2: (Enter second line of Unit's official shipping address; normally the building number of the DMO/TMO.)		
18. LINE 3: (Enter third line of Unit's official shipping address; normally the street address or Post Office Box of the DMO/TMO.)		
19. LINE 4: (Enter fourth line of Unit's official mailing address in the following fields; normally the supporting DMO/TMO.)		
19A. COUNTRY (--mil-, fip-, fms-)	19B. STATE/APO/PROVINCE:	
19C. CITY:	19D. ZIP CODE:	19E. INTERNATIONAL ZIP CODE:
20. LINE 1 (RESERVED FOR DLA USE ONLY.)		
SECTION VI - TAC 3 INFORMATION		
21. LINE 1: (Enter first line of the Unit's official billing address.)		
22. LINE 2: (Enter second line of Unit's official billing address.)		
23. LINE 3: (Enter third line of Unit's official billing address; normally the street address or Post Office Box of the unit/activity.)		
24. LINE 4: (Enter fourth line of Unit's official billing address in the following fields.)		
24A. COUNTRY (--mil-, fip-, fms-)	24B. STATE/APO/PROVINCE:	
24C. CITY:	24D. ZIP CODE:	24E. INTERNATIONAL ZIP CODE:
25. LINE 1 (RESERVED FOR DLA USE ONLY.)		
26. ADSN/FSN: (Enter 067443, except for MGLC Navy Working Capital Fund DoDAAC's use 067004.)		
SECTION VII - TRANSPORTATION INFORMATION		
27. CONSOLIDATION AND CONTAINERIZATION POINT (CCP): <input type="text"/>	28. BREAK BULK POINT: (Enter DoDAAC of supporting DMO/TMO/DMC or any subsequent BBP.)	29. AERIAL PORT OF DEBARKATION (APOD): (Enter the applicable APOD.)
		30. WATER PORT OF DEBARKATION (WPOD): (Enter the applicable WPOD.)
SECTION VIII - POINT OF CONTACT INFORMATION		
31. POC NAME: (Enter POC of person primarily associated with this DoDAAC; Last, First, Middle Initial. - For Contractor DoDAAC's, enter POC of Government representative.)		
32. POC E-MAIL:	33. POC PHONE NUMBER: (10 digit commercial/DSN.)	

Reset Form

FOR OFFICIAL USE ONLY

NAVMC 11718 (Rev. 12-2014) (EF) Page 3  
 FOUO - Privacy sensitive when filled in.

SECTION IX - CONTRACTOR INFORMATION <i>(Enter the following information if DoDAAC is for a USMC Contractor.)</i>		
34. CONTRACT NUMBER:	35. CAGE CODE:	36. CONTRACT ADMINISTRATION OFFICE: <i>(Enter DoDAAC of Procurement Authority for this contract.)</i>
37. CONTRACT SPONSOR: <i>(Enter Requisitioning DoDAAC of Command that funded this contract.)</i>		38. CONTRACT EXPIRATION DATE:
SECTION X - APPROVAL AUTHORITY INFORMATION <i>(For Contractor DoDAACs, complete blocks 44 &amp; 45 only. For Marine DoDAACs, complete blocks 46 through 48.)</i>		
CONTRACTOR DODAACS (L) - (If this request is for a Contractor DoDAAC, enter approvals in blocks 44 and 45 only.)		
39.a. CONTRACT SPONSOR: <i>(Enter rank/full name of contracting officer or funding authority approving this contract.)</i>	b. SPONSOR SIGNATURE 	c. Date
40.a. MANAGEMENT CONTROL ACTIVITY (MCA): <i>(Enter rank/full name of MCA Authority approving this request.)</i>	b. MCA (MAJCOM) 	c. Date
By affixing signature hereto, the MCA verifies the information contained herein and approves this request to update the DoDAAF, MCA, stop here and forward to CSP.		
MARINE DODAACS (M) - (The following signature blocks document the commander's authority for this DoDAAC and ties the responsibility for any business processes using this DoDAAC to this commander. Supply Officer approval is necessary only for authority code 00. The MAJCOM DoDAAC Monitor approval is required for all NAVMC 11718s.)		
41.a. SUPPLY OFFICER: <i>(Enter rank/full name if requesting full authority.)</i>	b. SUPPLY OFFICER SIGNATURE 	c. Date
42.a. COMMANDING OFFICER: <i>(Enter rank/full name of this DoDAAC's/RIC's authority.)</i>	b. COMMANDER'S OFFICER (SIGNATURE) 	c. Date
By affixing signature hereto, the Commander acknowledges responsibility for all resources managed by and through this DoDAAC.		
43.a. COMPTROLLER OFFICER (G-8) <i>(Enter rank/full name of this DoDAAC's/RIC authority.)</i>	b. COMPTROLLER OFFICER SIGNATURE 	c. Date
44.a. MAJCOM DODAAC MONITOR <i>(Enter rank/full name MAJCOM MONITOR)</i>	b. MAJCOM SIGNATURE 	c. Date
By affixing signature hereto, the MAJCOM Monitor verifies the information contained herein and approves this request to update the DoDAAF.		
45.a. HQMC: Authority codes 00, 02, & 05 <i>(Enter approved authority code &amp; comments)</i>	Approved Code  Amplifying Comments	b. HQMC APPROVAL SIGNATURE 
46.a. CENTRAL SERVICE POINT: Request completed (sign and date).	Amplifying Comments	b. CSP SIGNATURE 

Reset Form

FOR OFFICIAL USE ONLY

Available for download from the Department of the Navy, Naval Forms Online (NFOL)  
website at: <https://navalforms.documentservices.dla.mil>

**MANAGEMENT OF PROPERTY IN THE POSSESSION OF THE MARINE CORPS**  
**Appendix F** **MCO 4400.201-V2**

13 JUN 2016

INSTRUCTIONS FOR COMPLETING DODAAC / RIC REQUEST FORM					
Field No.	DODAAC / RIC FIELD		DEFINITION	SPONSOR/ACTION OFFICE	INSTRUCTIONS
	NAME	NUMBER OF CHARACTERS			
<b>SECTION I - TYPE OF REQUEST</b>					
A - F	Type of Request		DoDAAC or RIC. For DoDAAC, is it a new DoDAAC, update to existing DoDAAC, deletion, or Unit Rotation? For RIC, is it a new RIC, or an update/deletion of an existing RIC.	Unit	Check the box that applies. If new DODAAC, enter DODAAC being requested (if applicable). This would usually come from the MCOB 5460. If update/change/delete, enter the DODAAC being affected. If Unit Rotation, enter all DODAACs being affected. If the request is for a RIC, enter the RIC and associated DoDAAC of the RIC.
G	Reason		Explanation as to why this DoDAAC / RIC is either being requested or updated. Provide purpose for which the DoDAAC / RIC will be used.	Unit	Enter full justification for which a DODAAC/RIC is being requested (i.e., requisitioning, shipping, free-issue, etc.)
<b>SECTION II - IDENTIFY AND AUTHORITY INFORMATION</b>					
1	UIC	6	UIC from Total Force Structure Management System (TFSMS) or Defense Readiness Reporting System-Marine Corps (DRRS-MC) used for Readiness Reporting and Equipment Allowance Information.	UNITTFSMS/DRRS-MC	EVERY DoDAAC must be associated to a UIC. Enter the UIC from TFSMS or DRRS-MC for this unit to which the DoDAAC will be associated.
2	Major Command (MAJCOM) Code	2	Major Command Code	ISL LP	Enter two-digit command code from Major Command Code table (attached)
3	Authority Code	2	Authority Code (see Authority Code table)	ISL LP	Enter code from table (attached). NOTE: 00, 02 & 05 must be approved by HQMC and require completion of Section II (except for HAF activities).
4	Procurement Authority Flag	1	Procurement Authority Flag has been requested by the Acquisition Community to track which DoDAACs have been given procurement authority. Units without a procurement flag cannot write contracts against their DoDAAC.	ISL LB	If unit will be performing contracting actions, request for procurement authority must be obtained separately from HQMC DC ISL LB, and the warranted contracting officer identified in that request.
5	Status COMMR	7	Data System Communication Routing Identifier (COMMR)	MCLC	Enter DP COMMR
6	Billing COMMR	7	Billing COMMR	MCLC	Enter Billing COMMR
<b>SECTION III - STANDARD ACCOUNTING, BUDGET AND REPORTING SYSTEM (SABRS) HIERARCHY</b>					
7	MRI	6	A Major Command Recipient is a command that receives funds directly from HQMC. MRIs may pass funds to ARIs within their command.	PMR/Comptroller	Enter the MRI for this DoDAAC.
8	ARI	6	An Allotment Recipient Identifier is a command that receives an allotment or OPBUID from a MRI. MRIs are also ARIs when they pass funds to themselves.	PMR/Comptroller	Enter the ARI for this DoDAAC (blank if request is for an ARI or above).
9	SRI	6	A Suballotment Recipient Identifier is a subordinate command that receives a portion of an allotment or OPBUID from an ARI. MRIs are also ARIs/SRIs when they pass funds to themselves. SRI is the lowest level at which legal responsibility (31 USC 1517 authority) can be passed.	PMR/Comptroller	Enter the SRI for this DoDAAC (blank if request is for an SRI or above).
10	WCI	6	A Work Center Identifier is a subdivision of a SRI. These activities are held administratively responsible (31 USC 1514).	PMR/Comptroller	Enter the WCI for this DoDAAC (blank if request is for a WCI or above).
<b>SECTION IV - TAC 1 INFORMATION</b>					
11	T1_ADDR1	35	The first line (normally name) of the mailing address of the unit, activity, or organization that is authorized to order/requisition material from the DOD Logistics System.	Postal	Enter first line of mailing address (normally Commanding Officer)
12	T1_ADDR2	35	The second line (normally the street address) of the mailing address of the unit, activity, or organization that is authorized to order/requisition material from the DOD Logistics System.	Postal	Enter second line of mailing address (normally unit name)
13	T1_ADDR3	35	The third line of the mailing address of the unit, activity, or organization that is authorized to order/requisition material from the DOD Logistics System.	Postal	Enter third line of mailing address (normally PO Box info)
14	T1_ADDR4	35	The fourth line of the mailing address of the unit, activity, or organization that is authorized to order/requisition material from the DOD Logistics System.	Postal	The fourth line of the TAC is system-generated based on information provided in the following fields:
14A	Country		List the name of the Country in which this DoDAAC is physically located. If this is an APO/FPO, list United States and enter the APO/FPO in the State field.	Postal	Enter country
14B	State/APO/Province		State, APO/FPO, or Province.	Postal	Enter State, Province, or APO/FPO.
14C	City		City	Postal	Enter the City
14D	ZIP		Full ZIP Code and suffix.	Postal	Enter the ZIP code and suffix.
14E	T1_IPC_ZIP	10	International Postal Code. There are two postal code fields in the DoDAAC. The 'zip' is used exclusively for United States Postal codes. The IPC_ZIP is used for all other countries. Postal code data for non-US countries can be obtained by contacting the country's post office directly.	Postal	Enter as applicable
15	T1_ADDR5	35	The Military Shipping Label (MSL) supports five lines and USPS requires the country name be spelled out in English on the last line of the address. The 5th line is reserved solely for the country name associated with the ISO 3166-1 country code and is automatically created for the MSL by the other data elements of the TAC.	DLA	DLA use only.
<b>SECTION V - TAC 2 INFORMATION</b>					
16	T2_ADDR1	35	The first line (normally name) of the mailing address of the ship to activity.	ISL LPD and DMO/TMO	Enter first line of the shipping address (i.e., TMO, MDC, etc.)
17	T2_ADDR2	35	The second line (normally the street address) of the ship to activity.	ISL LPD and DMO/TMO	Enter second line of shipping address (i.e., unit name)
18	T2_ADDR3	35	The third line of the mailing address of the ship to activity.	ISL LPD and DMO/TMO	Enter third line of shipping address (i.e., Bldg # of location of TMO, MDC, etc.)
19	T2_ADDR4	35	The fourth line of the mailing address of the ship to activity.	ISL LPD and DMO/TMO	Enter fourth line of shipping address (i.e., city/base, state, & ZIP)
19A	Country		List the name of the Country in which this DoDAAC is physically located. This CANNOT be an APO/FPO.	Postal	Enter country. NOTE: Foreign countries MUST also enter OCP & APOC/WPOD info.
19B	State/Province		State or Province. CANNOT be an APO/FPO.	Postal	Enter State or Province
19C	City		Enter the name of the City.	Postal	Enter the City
19D	ZIP	10	Enter the full ZIP Code and suffix.	Postal	Enter the ZIP code and suffix.
19E	T2_IPC_ZIP	10	International Postal Code. There are two postal code fields in the DoDAAC. The 'zip' is used exclusively for United States Postal codes. The IPC_ZIP is used for all other countries. Postal code data for non-US countries can be obtained by contacting the country's post office directly.	Postal	Enter as applicable
20	T2_ADDR5	35	The Military Shipping Label (MSL) supports five lines and USPS requires the country name be spelled out in English on the last line of the address. The 5th line is reserved solely for the country name associated with the ISO 3166-1 country code and is automatically created for the MSL by the other data elements of the TAC.	DLA	DLA use only.



**MANAGEMENT OF PROPERTY IN THE POSSESSION OF THE MARINE CORPS**  
**Appendix F** **MCO 4400.201-V2**

13 JUN 2016

INSTRUCTIONS FOR COMPLETING DODAAC / RIC REQUEST FORM						
Field No.	DODAAC / RIC FIELD		DEFINITION	SPONSOR/ACTION OFFICE	INSTRUCTIONS	
	NAME	NUMBER OF CHARACTERS				
<b>SECTION I - TYPE OF REQUEST</b>						
A - F	Type of Request		DODAAC or RIC. For DoDAAC, is it a new DoDAAC, update to existing DoDAAC, deletion, or Unit Rotation? For RIC, is it a new RIC, or an update/deletion of an existing RIC.	Unit	Check the box that applies. If new DODAAC, enter DODAAC being requested (if applicable). This would usually come from the SCS/9400. If update/delete/deletion, enter the DODAAC being affected. If Unit Rotation, enter all DODAACs being affected. If the request is for a RIC, enter the RIC and associated DoDAAC of the RIC.	
G	Reason		Explanation as to why this DoDAAC / RIC is either being requested or updated. Provide purpose for which the DoDAAC / RIC will be used.	Unit	Enter full justification for which a DODAAC/RIC is being requested (i.e., requisitioning, shipping, free-issue, etc.)	
<b>SECTION II - IDENTIFY AND AUTHORITY INFORMATION</b>						
1	UIC	6	UIC from Total Force Structure Management System (TFSMS) or Defense Readiness Reporting System-Marine Corps (DRRS-MC). Used for Readiness Reporting and Equipment Allowance information.	UNITFSMS/DRRS-MC	EVERY DoDAAC must be associated to a UIC. Enter the UIC from TFSMS or DRRS-MC for the unit to which the DoDAAC will be associated.	
2	Major Command (MAJCOM) Code	2	Major Command Code	ISL LP	Enter two-digit command code from Major Command Code table (attached).	
3	Authority Code	2	Authority Code (see Authority Code table)	ISL LP	Enter code from table (attached). NOTE: 00, 02 & 05 must be approved by HQMC and require completion of Section II (except for NAF activities).	
4	Procurement Authority Flag	1	Procurement Authority Flag has been requested by the Acquisition Community to track which DoDAACs have been given procurement authority. Units without a procurement flag cannot enter contracts against their DoDAAC.	ISL LB	If unit will be performing contracting actions, request for procurement authority must be obtained separately from HQMC DC ISL LB, and the warranted contracting officer identified in that request.	
5	Status COMMM	7	Data Path/In Communication Routing Identifier (COMMM)	MCLC	Enter 0P COMMM	
6	String COMMM	7	String COMMM	MCLC	Enter String COMMM	
<b>SECTION III - STANDARD ACCOUNTING, BUDGET AND REPORTING SYSTEM (SABRS) HIERARCHY</b>						
7	MR	6	A Major Command Recipient is a command that receives funds directly from PS&M. MRs may pass funds to ARs within their command.	F&R/Comptroller	Enter the MR for this DoDAAC.	
8	AR	6	An Allowment Recipient Identifier is a command that receives an allotment or OPBLD from a MR. MRs are also ARs when they pass funds to themselves.	F&R/Comptroller	Enter the AR for this DoDAAC (blank if request is for an AR or above).	
9	SR	6	A Suballotment Recipient Identifier is a subordinate command that receives a portion of an allotment or OPBLD from an AR. MRs are also ARs/SRs when they pass funds to themselves. SR is the lowest level at which legal responsibility (31 USC 1517) authority can be passed.	F&R/Comptroller	Enter the SR for this DoDAAC (blank if request is for an SR or above).	
10	WG	6	A Work Center Identifier is a subdivision of a SR. These activities are held administratively responsible (31 USC 1514).	F&R/Comptroller	Enter the WG for this DoDAAC (blank if request is for a WG or above).	
<b>SECTION IV - TAC 1 INFORMATION</b>						
11	T1_ADDR1	35	The first line (normally name) of the mailing address of the unit, activity, or organization that is authorized to order/requisition material from the DOD Logistics System.	Postal	Enter first line of mailing address (normally Commanding Officer)	
12	T1_ADDR2	35	The second line (normally the letter address) of the mailing address of the unit, activity, or organization that is authorized to order/requisition material from the DOD Logistics System.	Postal	Enter second line of mailing address (normally unit name)	
13	T1_ADDR3	35	The third line of the mailing address of the unit, activity, or organization that is authorized to order/requisition material from the DOD Logistics System.	Postal	Enter third line of mailing address (normally PO Box info)	
14	T1_ADDR4	35	The fourth line of the mailing address of the unit, activity, or organization that is authorized to order/requisition material from the DOD Logistics System.	Postal	The fourth line of the TAC is system-generated based on information provided in the following fields.	
14A	Country		List the name of the Country in which this DoDAAC is physically located. If this is an APO/FPO, list United States and enter the APO/FPO in the State field.	Postal	Enter country	
14B	State/APO/Province		State, APO/FPO, or Province.	Postal	Enter State, Province, or APO/FPO	
14C	City		City	Postal	Enter the City	
14D	ZIP		Full ZIP Code and suffix	Postal	Enter the ZIP code and suffix	
14E	T1_IPC_ZIP	10	International Postal Code. There are two postal code fields in the DoDAAC. The "zip" is used exclusively for United States Postal codes. The IPC_ZIP is used for all other countries. Postal code data for non-US countries can be obtained by contacting the country's post office directly.	Postal	Enter as applicable	
15	T1_ADDR5	35	The Military Shipping Label (MSL) supports five lines and USPS requires the country name be spelled out in English on the last line of the address. The MS line is reserved solely for the country name associated with the ISO 3166-1 country code and is automatically created for the MSL by the other data elements of the TAC.	DLA	DLA use only.	
<b>SECTION V - TAC 2 INFORMATION</b>						
16	T2_ADDR1	35	The first line (normally name) of the mailing address of the ship to activity.	ISL LFD and DMGTMO	Enter first line of the shipping address (i.e., TMO, MOC, etc.)	
17	T2_ADDR2	35	The second line (normally the street address) of the ship to activity.	ISL LFD and DMGTMO	Enter second line of shipping address (i.e., unit name)	
18	T2_ADDR3	35	The third line of the mailing address of the ship to activity.	ISL LFD and DMGTMO	Enter third line of shipping address (i.e., Bldg # of location of TMO, MOC, etc.)	
19	T2_ADDR4	35	The fourth line of the mailing address of the ship to activity.	ISL LFD and DMGTMO	Enter fourth line of shipping address (i.e., city/state, state, & ZIP)	
19A	Country		List the name of the Country in which this DoDAAC is physically located. This CANNOT be an APO/FPO.	Postal	Enter country. NOTE: Foreign countries MUST also enter CCP & APO/FPO info.	
19B	State/Province		State or Province. CANNOT be an APO/FPO.	Postal	Enter State or Province	
19C	City		Enter the name of the City	Postal	Enter the City	
19D	ZIP	10	Enter the full ZIP Code and suffix	Postal	Enter the ZIP code and suffix	
19E	T2_IPC_ZIP	10	International Postal Code. There are two postal code fields in the DoDAAC. The "zip" is used exclusively for United States Postal codes. The IPC_ZIP is used for all other countries. Postal code data for non-US countries can be obtained by contacting the country's post office directly.	Postal	Enter as applicable	
20	T2_ADDR5	35	The Military Shipping Label (MSL) supports five lines and USPS requires the country name be spelled out in English on the last line of the address. The MS line is reserved solely for the country name associated with the ISO 3166-1 country code and is automatically created for the MSL by the other data elements of the TAC.	DLA	DLA use only.	

**MANAGEMENT OF PROPERTY IN THE POSSESSION OF THE MARINE CORPS**  
**Appendix F** **MCO 4400.201-V2**  
**13 JUN 2016**

INSTRUCTIONS FOR COMPLETING DODAAC / RIC REQUEST FORM (continued)					
Field No.	DODAAC FIELD		DEFINITION	SPONSORATION OFFICE	INSTRUCTIONS
	NAME	NUMBER OF CHARACTERS			
<b>SECTION VI - TAC 3 INFORMATION</b>					
21	TS_ADDR1	20	The first line (usually series) of the mailing address of activity that will make payment (bill to address).	PBR / Comptroller	Enter first line of billing information (usually "DFAS COLUMBUS" if for a Marine unit)
22	TS_ADDR2	35	The second line (usually the street address) of activity that will make payment (bill to address).	PBR / Comptroller	Enter second line of billing information (ATTN:KUNSGS-C/FY)
23	TS_ADDR3	35	The third line of the mailing address of activity that will make payment (bill to address).	PBR / Comptroller	Enter third line of billing information (PO BOX 369022)
24	TS_ADDR4	30	The last line of the mailing address of activity that will make payment (bill to address).	PBR / Comptroller	Enter fourth line of billing information (COLUMBUS OH 43239 8022)
24A	Country		List the name of the Country which the DODAAC is physically located. If this is an AFPO/FPO, list United States and enter the FPO in the State field.	Postal	Enter country
24B	State/FPO/Province		Enter the State, AFPO/FPO, or Province.	Postal	Enter State, Province, or AFPO/FPO
24C	City		Enter the name of the City.	Postal	Enter the City
24D	ZIP	10	Enter the full ZIP Code and suffix.	Postal	Enter the ZIP code and suffix
24E	TS_ZIP_ZIP	10	Enter additional Postal Code. There are two postal code fields in the DODAAC. The first is used only for United States Postal codes. The TS_ZIP_ZIP is used for all other countries. Postal code data for non-US countries can be obtained by contacting the country's post office directly.	Postal	Enter as applicable
25	TS_ADDR5	25	The Military Shipping Label (MSL) supports five lines and USPS requires the country name be spelled out in English on the last line of the address. The fifth line is reserved solely for the country name associated with the (SC 218) 1 country postal and is automatically created for the MSL by the other data elements of the TAC.	DLA	DLA use only.
26	ADDR_PSN	6	Accounting Deliberating System Number/Postal Station Number. This code identifies the Service payment office. This field is not validated within the DODAAC. It is Service defined and Service dependent. Army and Air Force use a five digit numeric code. Navy and Marine mostly use a DoDAAC, DLA and Other (NWS, NSA, etc.) use a mix of numeric codes and DoDAACs.	Unit	Enter default for all DODAACs except for MSLC DODAACs; that use Navy Working Capital Plans, in which case use 00706.
<b>SECTION VII - TRANSPORTATION INFORMATION</b>					
27	CCP	3	Consolidation and Cost administration Point. The code applies when supplies are to be shipped via surface freight. The code is defined in the Defense Transportation Regulation (DTR) and contains values are only the valid values for a COP, 121 (East Coast Consolidation Point, address found in DoDAAC NSGN14) or 301 (West Coast Consolidation Point, address found in DoDAAC WSN2DA).	ML LPO and DMO/TMO	Enter the COP if this is an OCONUS DoDAAC (181 or 301).
28	T2_BSP	7	Break Bulk Point. The location that material is shipped to and broken into smaller shipments for onward movement. NOTE: Only one BSP is ever active at one time. If the TAC 2 is blank, the T1_BSP is the true BSP.	ML LPO and DMO/TMO	Enter DODAAC of supporting DMO/TMO/DMC.
29	T2_APOD	3	Final Part of Despatch. The code is defined in the Defense Transportation Regulation (DTR). DODAAC downloads a table of APOD information from USSTRANSCOM that the drop-down values in the DODAAC update application. A new copy of the APOD is downloaded every time the table is updated by USSTRANSCOM.	ML LPO and DMO/TMO	Enter the APOD if this is an OCONUS DoDAAC.
30	T2_WPOD	3	Water Port of Despatch. The code is defined in the Defense Transportation Regulation (DTR). DODAAC downloads a table of WPOD information from USSTRANSCOM that the drop-down values in the DODAAC update application. A new copy of the WPOD is downloaded every time the table is updated by USSTRANSCOM.	ML LPO and DMO/TMO	Enter the WPOD if this is an OCONUS DoDAAC.
<b>SECTION VIII - POINT OF CONTACT INFORMATION</b>					
31	POC_NAME	50	Point of Contact. Identifies the POC that can provide information on the DODAAC Mutual Covertions.	Unit	Enter full, five, alpha value of POC for this DODAAC
32	POC_EMAIL	40	Email of Government POC.	Unit	Enter email address of POC.
33	POC_PHONE_NUMBER	25	Telephone of POC.	Unit	Enter 10 digit commercial phone number of POC or 10 digit DSN # OCONUS.
<b>SECTION IX - CONTRACTOR INFORMATION</b>					
(NOTE: A USMC Contractor DoDAAC is only required if the contract is between the USMC and the private company.)					
34	CONTRACT_NO	17	Contract Number as filed in when the DODAAC accepts it as a contractor with an active contract.	Unit/Contracting Office	Enter the USMC Contract number that establishes the agreement between the USMC and the private company.
35	CAGE_CODE	8	Commercial and Government Entity Code, identifies the activity.	Unit/Contracting Office	Enter the CAGE Code from the Central Contractor Registry database (CCR) for this private company.
36	CONTRACT_ACMN_DFP	6	DODAAC of Procurement Authority that wrote the contract.	Unit/Contracting Office	Enter the DODAAC of the Procurement Authority that approved the contract.
37	CONTRACT_SPONSORING_AGENCY	6	The Authority Code (O) DoDAAC of the unit whose appropriations were obligated to fund this contract.	Unit/Contracting Office	Enter the Requesting DoDAAC of the unit funding this contract.
38	CONTRACT_EXPI_DATE	8	Contract Expiration Date.	Unit/Contracting Office	Enter contract expiration date (MM/DD/YYYY).
<b>SECTION X - APPROVAL AUTHORITY INFORMATION</b>					
(NOTE: Contractor DoDAAC requests use blocks 39-43. Marine DoDAAC requests use blocks 44 through 46.)					
<b>CONTRACTOR DoDAACs</b>					
39	CONTRACT_SPONSOR	50	For contractor DoDAACs, enter the approval of either the Contracting Office that wrote the contract or the Contract Authority who requested and approved the funding for this contract (i.e., MSLC ALPS, MSLC FOD, etc.)	Activity	Enter the rank/name of Contract Sponsor. Digitally sign and date.
40	MANAGEMENT_ACTIVITY	NA	All contractor DoDAACs have the sole purpose of providing a means to account for and ship Government Furnished Property (GFP) or Contractor Acquired Material (CAM) per the contract terms of MCO 4400.201. The MCA is responsible to the Marine Corps for accounting for GFP/CAM and is therefore the MAJCOM for all contractor DoDAACs.	MCA	Enter the rank/name of MCA. Digitally sign and date. Contractor DoDAAC Request can be forwarded to HQMC at this point.
<b>MARINE DoDAACs</b>					
41	SUPPLY OFFICER	NA	For requisitioning DoDAACs, list the name of the Supply Officer responsible for accounting for goods and services procured by this DoDAAC. Authority Code (O) requests the unit supply officer or a validated contracting officer.	Unit/Activity	Enter the rank/name of unit supply officer. Digitally sign and date.
42	COMMANDING OFFICER	NA	DoDAACs are accountable to a Commander. List the name of the CO accountable for this DoDAAC's use.	Unit/Activity	Enter the rank/name of commanding officer of unit. Digitally sign and date. Forward to MAJCOM.
43	COMPTROLLER OFFICER	NA	COMPTROLLER IS RESPONSIBLE FOR UNIT'S FINANCIAL HIERARCHY (BRG, ASB, SBL, AND WFO).	Unit/Activity/GB	Enter the rank/name of Comptroller Officer G-6. Digitally sign and date Forward to MAJCOM DoDAAC Monitor.
44	MAJCOM DODAAC WFO/DT	NA	The MAJCOM DoDAAC Monitor is responsible to manage all DODAACs within the MAJCOM. All requests within a given MAJCOM shall be approved by the MAJCOM Monitor.	MAJCOM	Enter the MAJCOM DODAAC Monitor's information. Digitally sign as (1 5 2) (7) (unit) (1211).
45	HQMC	NA	HQMC approval. HQMC shall approve all DoDAAC requests which change Authority Code and/or requests for Procurement Authority.	NA/HQMC	HQMC will approve or provide amplifying comments. Digitally sign and date.
46	CSP	NA	The CSP will execute the approved changes and document that the request has been completed.	MAJCOM	CSP will provide comments and document completion (or rejection) as necessary. Digitally sign and date.

**MANAGEMENT OF PROPERTY IN THE POSSESSION OF THE MARINE CORPS**  
**Appendix F** **MCO 4400.201-V2**  
**13 JUN 2016**

INSTRUCTIONS FOR COMPLETING DODAAC / RIC REQUEST FORM (continued)						
Field No.	DODAAC FIELD		DEFINITION	SPONSOR/FUNCTION OFFICE	INSTRUCTIONS	
	NAME	NUMBER OF CHARACTERS				
<b>SECTION VI - TAC 3 INFORMATION</b>						
21	T3_ADDR1	35	The first line (normally name) of the mailing address of activity that will make payment (bill to address)	PAU / Comptroller	Enter first line of billing information (normally "OFAS COLUMBUS" if for a Marine unit)	
22	T3_ADDR2	35	The second line (normally street address) of activity that will make payment (bill to address)	PAU / Comptroller	Enter second line of billing information (ATTN KINGSGAS CITY)	
23	T3_ADDR3	35	The third line of the mailing address of activity that will make payment (bill to address)	PAU / Comptroller	Enter third line of billing information (PO BOX 396022)	
24	T3_ADDR4	35	The last line of the mailing address of activity that will make payment (bill to address)	PAU / Comptroller	Enter fourth line of billing information (COLUMBUS OH 43236-6022)	
25A	Country		List the name of the Country in which the DoDAAC is physically located. This is an APO/FPO, but United States and enter the FPO in the State field.	Postal	Enter country	
25B	State/AFPO/Province		Enter the State, AFPO/FPO, or Province.	Postal	Enter State, Province, or AFPO/FPO	
25C	City		Enter the name of the City.	Postal	Enter the City	
25D	ZIP	10	Enter the full ZIP Code and suffix.	Postal	Enter the ZIP code and suffix	
25E	T3_IPC_ZIP	10	International Postal Code. There are two postal code fields in the DoDAAC. The "IP" is used exclusively for United States Postal codes. The IPC_ZIP is used for all other countries. Postal code data for non-US countries can be obtained by contacting the country's post office directly.	Postal	Enter as applicable	
26	T3_ADDR5	35	The Military Shipping Label (MSL) supports five lines and USPS requires the country name be spelled out in English on the last line of the address. The fifth line is reserved solely for the country name associated with the ISO 3166-1 country code and is automatically created for the MSL by the other data elements of the TAC.	DIA	DIA use only.	
26	ACSN_FSN	8	Accounting/Disbursing Station Number/Postal Station Number. This code identifies the Service payment office. This field is not validated within the DoDAAC. It is Service defined and Service dependent. Army and Air Force use a five digit number code. Navy and Marine mostly use a DoDAAC, DIA and other (WFE, NSA, etc.) use a mix of number codes and DoDAACs.	Unit	Enter MSLed for all DoDAACs except for MSLC DoDAACs that use the Navy Working Capital Fund. In which case use 00704.	
<b>SECTION VII - TAC 4 INFORMATION</b>						
27	T4_ADDR1	35	The first line (normally name) of the mailing address used for delivery of small parcel carriers (used only when the T2 address is not sufficient for delivery)	Postal (DMO) / TMO	Enter first line of mailing address (normally Commanding Officer)	
28	T4_ADDR2	35	The second line (normally the street address) of the mailing address used for delivery of small parcel carriers (used only when the T2 address is not sufficient for delivery)	Postal (DMO) / TMO	Enter second line of mailing address (normally unit name)	
29	T4_ADDR3	35	The third line of the mailing address used for delivery of small parcel carriers (used only when the T2 address is not sufficient for delivery)	Postal (DMO) / TMO	Enter third line of mailing address (must be an actual location - 98q no)	
30	T4_ADDR4	35	The last line of the mailing address used for delivery of small parcel carriers (used only when the T2 address is not sufficient for delivery)	Postal (DMO) / TMO	Enter fourth line of mailing address (normally city/state, zip, etc code)	
30A	Country		List the name of the Country in which the DoDAAC is physically located. This is an APO/FPO, but United States and enter the FPO in the State field.	Postal	Enter country	
30B	State/AFPO/Province		Enter the State, AFPO/FPO, or Province.	Postal	Enter State, Province, or AFPO/FPO	
30C	City		Enter the name of the City.	Postal	Enter the City	
30D	ZIP	10	Enter the full ZIP Code and suffix.	Postal	Enter the ZIP code and suffix	
30E	T4_IPC_ZIP	10	International Postal Code. There are two postal code fields in the DoDAAC. The "IP" is used exclusively for United States Postal codes. The IPC_ZIP is used for all other countries. Postal code data for non-US countries can be obtained by contacting the country's post office directly.	Postal	Enter as applicable	
31	T4_ADDR5	35	The Military Shipping Label (MSL) supports five lines and USPS requires the country name be spelled out in English on the last line of the address. The fifth line is reserved solely for the country name associated with the ISO 3166-1 country code and is automatically created for the MSL by the other data elements of the TAC.	DIA	DIA use only.	
<b>SECTION VIII - TRANSPORTATION INFORMATION</b>						
32	COF	3	Consolidation and Containerization Point. The code applies when supplies are to be shipped via surface freight. The code is defined in the Defense Transportation Regulation (DTR) and containers are only for unit issues for a COP: 101 (East Coast Consolidation Point, address found in DoDAAC W029114) or 301 (West Coast Consolidation Point, address found in DoDAAC W62024).	USL LPO and DMO/TMO	Enter the COF if this is an OCONUS DoDAAC (01 or 301).	
33	T3_BSP	7	Break Bulk Point, the location that material is shipped to and broken into smaller shipments for onward movement. MCOE: DoD use BSP is user action at use time. If the TAC 2 is blank, the T3_BSP is the true BSP.	USL LPO and DMO/TMO	Enter DoDAAC of supporting DMO/TMO/DAC.	
34	T3_APOD	3	Anti Port of Detachment. The code is defined in the Defense Transportation Regulation (DTR). DAASC downloads a table of APOD information from USTRANSCOM's Anti-Port of Detachment values in the DoDAAC update application. A new copy of the APOD is downloaded every time the table is updated by USTRANSCOM.	USL LPO and DMO/TMO	Enter the APOD if this is an OCONUS DoDAAC.	
35	T3_WPOD	3	Water Port of Detachment. The code is defined in the Defense Transportation Regulation (DTR). DAASC downloads a table of WPOD information from USTRANSCOM's Anti-Port of Detachment values in the DoDAAC update application. A new copy of the WPOD is downloaded every time the table is updated by USTRANSCOM.	USL LPO and DMO/TMO	Enter the WPOD if this is an OCONUS DoDAAC.	
<b>SECTION IX - POINT OF CONTACT INFORMATION</b>						
36	POC_NAME	NA	Point of Contact. Identifies the POC that can provide information on the DoDAAC.	Unit	Enter last, first, middle initial of POC for the DoDAAC.	
37	POC_EMAIL	40	Email of Government POC.	Unit	Enter full e-mail address of POC.	
38	POC_PHONE_NUMBER	21	Telephone of POC.	Unit	Enter 10-digit commercial phone number of POC or 10-digit DSN if OCONUS.	
<b>SECTION X - CONTRACTOR INFORMATION</b>						
(NOTE: A USMC Contractor DoDAAC is only required if the contract is between the USMC and the private company.)						
39	CONTRACT_NO	17	Contract number as filed in when the DoDAAC belongs to a contractor with an active contract.	Unit/Contracting Office	Enter the USMC Contract number that establishes the agreement between the USMC and the private company.	
40	GAGE_CODE	5	Commercial and Government Entity Code. Identifies the activity.	Unit/Contracting Office	Enter the GAGE Code from the Central Contractor Registry database (CCR) for the private company.	
41	CONTRACTING OFFICE	8	DoDAAC of Procurement Authority that wrote the contract.	Unit/Contracting Office	Enter the DoDAAC of the Procurement Authority that approved the contract.	
42	CONTRACTING AGENCY	8	The Authority Code 00 DoDAAC of the unit whose appropriations were obligated to fund this contract.	Unit/Contracting Office	Enter the Requisitioning DoDAAC of the unit funding this contract.	
43	CONTRACT_EXPIRES	8	Contract Expiration Date.	Unit/Contracting Office	Enter contract expiration date (ddmmyyyy).	
<b>SECTION XI - APPROVAL AUTHORITY INFORMATION</b>						
(NOTE: Contractor DoDAAC requests use blocks #1 & #5. Marine DoDAAC requests use blocks #1 through #4.)						
<b>CONTRACTOR DoDAACs</b>						
44	CONTRACT SPONSOR	NA	For contractor DoDAACs, enter the approval of either the Contracting Officer that wrote the contract or the Command Authority who requested and approved the funding for this contract (i.e., MCOE AOPS, WGLC ROD, etc.)	Activity	Enter the nickname of Contract Sponsor. Digitally sign and date.	
45	MANAGEMENT CONTROL ACTIVITY (MCA)	NA	All contractor DoDAACs serve the sole purpose of providing a means to account for and ship Government Furnished Property (GFP) or Contractor Acquired Material (CAM), per the terms of MOD 7400 (IG). The MCA is responsible for the Marine Corps for accounting for GFP/CAM and is therefore the MAJCOM for all contractor DoDAACs.	MCA	Enter the nickname of MCA. Digitally sign and date. Contractor DoDAAC Request can be forwarded to HQMC at this point.	
<b>MARINE DoDAACs</b>						
46	SUPPLY OFFICER	NA	For requisitioning DoDAACs, list the name of the Supply Officer responsible for accounting for goods and services procured by this DoDAAC. Authority Code 05 requires the unit/activity to be a supply officer or warranted contracting officer.	Unit/Activity	Enter the nickname of unit supply officer. Digitally sign and date.	
47	COMMANDING OFFICER	NA	DoDAACs are accountable to a Commander. List the name of the CO accountable for the DoDAAC's use.	Unit/Activity	Enter the nickname of commanding officer of unit. Digitally sign and date. Forward to MAJCOM.	
48	COMPTROLLER OFFICER	NA	COMPTROLLER IS RESPONSIBLE FOR UNITS FINANCIAL HIERARCHY (MFC, AFS, SR, AND WGLC).	Unit/Activity/US	Enter the nickname of Comptroller Officer G-5. Digitally sign and date. Forward to MAJCOM DoDAAC Monitor.	
49	MAJCOM DoDAAC MONITOR	NA	The MAJCOM DoDAAC Monitor is responsible to manage all DoDAACs within the MAJCOM. All requests within a given MAJCOM unit be approved by the MAJCOM Monitor.	MAJCOM	Enter the MAJCOM DoDAAC Monitor's information. Digitally sign and date. Forward to HQMC.	
50	HQMC	NA	HQMC approval. HQMC shall approve all DoDAAC requests which change Authority Code enable for requests for Procurement Authority.	MAJCOM	HQMC will approve or provide any other comments. Digitally sign and date.	
51	CSP	NA	The CSP will approve the approved changes and document that the request has been completed.	MAJCOM	CSP will provide comments and document completion (or rejection) as necessary. Digitally sign and date.	

**VOLUME 2: APPENDIX G**

**“NAVY UIC DODAAC REQUEST”**

**SUMMARY OF SUBSTANTIVE CHANGES**

Hyperlinks are denoted by ***bold, italic, blue and underlined font.***

The original publication date of this Marine Corps Order (MCO) Volume (right header) will not change unless/until a full revision of the MCO has been conducted.

All Volume changes denoted in **blue font** will reset to black font upon a full revision of this Volume.

CHAPTER VERSION	PAGE PARAGRAPH	SUMMARY OF SUBSTANTIVE CHANGES	DATE OF CHANGE

APPENDIX G

NAVY UIC – DODAAC REQUEST

NAVY UIC - DODAAC REQUEST DFAS-CLEVELAND TREASURY DIVISION CODE JAFBA					
HEADQUARTERS/BSO CONTACT WILL FORWARD REQUEST TO UIC_DODAAC@DFAS.MIL (UIC UNDERSCORE DODAAC AT DFAS.MIL). ADDITIONAL DETAILS CAN BE SUBMITTED VIA EMAIL. REQUIRED FIELDS HIGHLIGHTED OR STATE REQUIRED.					
<b>SECTION A. POINT OF CONTACT (POC) INFORMATION:</b>					
1. BSO/CMD HQTRS CONTACT NAME:		2. BSO NO:		3. DATE:	
4. REQUESTING ACTIVITY POC NAME:		5. PHONE:		6. E-MAIL ADDRESS:	
<b>SECTION B. UIC INFORMATION:</b>					
1. REQUEST TYPE: <input type="checkbox"/> NAVY <input type="checkbox"/> CONTRACTOR		2. ACTION:	3. EXISTING UIC NUMBER:		
4. PURPOSE CODE(S) ARE REQUIRED, A MAXIMUM OF 3 CAN BE SELECTED:		<input type="checkbox"/> C CONTRACTOR	<input type="checkbox"/> Z ADMIN	<input type="checkbox"/> F FINANCIAL	<input type="checkbox"/> D NIMA-DMA-ASO FORMS-PUBS
<input type="checkbox"/> M MATERIAL REQUISITIONING		<input type="checkbox"/> J JUMPS-MANPOWER-DJMS		<input type="checkbox"/> S SHIPPING	<input type="checkbox"/> N NCIS
5. UIC LONG TITLE /STREET ADDRESS/CITY/ STATE/ZIP/COUNTRY:					
6. SHORT TITLE:		7. PLA:		8. UIC AAA:	
<b>SECTION C. DODAAC INFORMATION: AN AUTHORITY CODE IS REQUIRED.</b>					
1. SERVICE DESIGNATOR: <input type="checkbox"/> N <input type="checkbox"/> R <input type="checkbox"/> V <input type="checkbox"/> Q		2. AUTHORITY CODE (SELECT 1):			
3. TAC ADDRESS CODES (1: MAILING, 2: SHIPPING, 3: BILLING)					
TAC 1:					
TITLE/STREET ADDRESS/CITY/ STATE/APO-FPO/ZIP CODE/COUNTRY:					
TAC 2 (NO BOXES APO, FPO, POB, ALLOWED IN TAC 2):				CHECK IF SAME AS TAC 1: <input type="checkbox"/>	
TITLE/STREET ADDRESS/CITY/ STATE-PROVINCE/ZIP CODE/COUNTRY:					
IF FOREIGN INCLUDE APOD/WPOD CODES.		APOD:		WPOD:	
TAC 3 BILLING ADDRESS:		CHECK IF SAME AS TAC 1: <input type="checkbox"/>		AAA/FSN:	
TITLE/STREET ADDRESS/CITY/ STATE/APO-FPO/ZIP CODE/COUNTRY:					
<b>SECTION D. CONTRACTOR INFORMATION:</b>					
1. CONTRACT NUMBER:		2. EXPIRATION DATE:		3. CAGE CODE:	
COMMENTS:					



**DFAS FORM 9025 INSTRUCTIONS**

**SECTION A: CONTACT INFORMATION**

1. BSO: Enter name of headquarters/BSO contact. 2. Enter BSO number. 3. Enter date.
4. Activity POC: Enter requestor name. 5. Enter requestor phone. 6. Enter requestor email.

**SECTION B: UIC INFORMATION**

1. Request Type: Indicate if request is for a Navy UIC/DODAAC or a Navy Contractor UIC/DODAAC.
2. Action: Indicate the type of action required: NEW (if request is for a new UIC/DODAAC to be established), UPDATE or DELETE (for an existing UIC/DODAAC). Note: A DODAAC may be disestablished without disestablishing the UIC. If the UIC is disestablished, the corresponding DODAAC will also be disestablished.
3. Existing UIC number: Enter existing UIC number for update or delete action of an existing UIC or DODAAC. For a new establishment leave blank, except for Military Sealift Command assigning vessels.
4. Purpose Codes: Select up to three purpose codes to indicate what the UIC will be used for:  
C- For Navy Contractors & Procurement Instrument Preparation. Contractor UICs are coded CM (Contractor - Material Requisitioner), or CS (Contractor - Shipping Only). Material requisitioning includes shipping and billing and the corresponding DODAAC's authority code would be 00 (Full Requisitioner), for CS the corresponding authority code would be 01 (Ship To Only).  
D - A component UIC to facilitate shipment of NIMA (formerly DMA) products or NAVICP formerly ASO) Cog 'I' materials (Forms and Pubs).  
F - Financial Accounting. An activity performs or has accounting for fund authorization, budget, NIF, RDT&E, property, payroll, inventory, or Appropriation Purchases Account.  
J - JUMPS. Joint Uniform Military Pay System. (JUMPS)/ Manpower and Personnel  
S - Shipping Only. Corresponding DODAACs will have an authority code 01 (Ship to Only).  
M - Material requisitioning. Corresponding DODAACs will be assigned authority code 00 (Full Requisitioning).  
N - Navy Cost Information System (NCIS)/Five Year Defense Program (FYDP).
5. UIC Title: Enter UIC long title, address, city, state, zip and province/country if needed.
6. Enter UIC short title (optional). 7. Enter Plain Language title (optional). 8. Enter Authorized Accounting Authority (Same as AAA/FSN DODAAC TAC 3).

**SECTION C: DODAAC INFORMATION**

1. Select service designator to assign to DODAAC: N = Standard Navy, R = Pacific Fleet Mobility, V = Atlantic Fleet Mobility, Q = Navy Contractor.
2. Select Authority Code for level of requisitioning authority to be assigned to the DODAAC.
3. TAC Address Codes:  
TAC 1: Enter the complete mailing address including full street number and name, foreign or domestic zip code, city, state, province and country information when needed.  
TAC 2: Same as TAC 1 except no boxes are allowed. TAC 2 must reflect a full physical address for freight deliveries. Foreign addresses should include air and water ports of debarkation if known.  
TAC 3: Enter Authorized Accounting Authority (AAA) or Financial Station Number (FSN). Enter complete mailing address or check same as TAC 1 if applicable.

**SECTION D: CONTRACTOR INFORMATION:**

1. Enter complete contract number. 2. Enter contract expiration date. 3. Enter contract cage code.

**13 JUN 2016**

DFAS Form 9025 – Navy UIC – DoDAAC Request. Available for download from the Department of the Navy, Naval Forms Online (NFOL) website at:

<https://navalforms.documentservices.dla.mil>

**VOLUME 2: APPENDIX H**

**“ADDITIONAL CRIF GUIDANCE”**

**SUMMARY OF SUBSTANTIVE CHANGES**

Hyperlinks are denoted by ***bold, italic, blue and underlined font.***

The original publication date of this Marine Corps Order (MCO) Volume (right header) will not change unless/until a full revision of the MCO has been conducted.

All Volume changes denoted in **blue font** will reset to black font upon a full revision of this Volume.

CHAPTER VERSION	PAGE PARAGRAPH	SUMMARY OF SUBSTANTIVE CHANGES	DATE OF CHANGE



**APPENDIX H**

**ADDITIONAL CRIF GUIDANCE**

1. The CRIF is the automated authoritative source for CONUS and OCONUS outbound cargo routing for all mobile naval units, deployed Coast Guard vessels, and aviation squadrons, including components of Expeditionary Strike Groups (ESG)/Amphibious Ready Groups (ARG). The CRIF provides shipping addresses for unit's transportation priority (TP) codes: one, two, and three to DLA TS. DLA TS distributes CRIF information to government sources of supply and logistics systems to ensure automated processing of shipments to the correct location. The CRIF can be used for CONUS/OCONUS addresses, as well as ship's addresses. Any location in the world can be loaded to the CRIF.
2. The CRIF allows units to synchronize delivery of resupply/sustainment with their movement, whether afloat or ashore, by specifying when and where it will be located during a deployment. For example, a MEU can have its material routed with the ship(s) it is embarked on; and a Navy Riverine Squadron can establish a derivative DoDAAC for a deployed unit and use the CRIF to route material to a particular location ashore. The pipeline established by the CRIF effectively reduces wait time by increasing materiel throughput velocity to deployed units.
3. Use of the CRIF enables naval expeditionary forces (supported units) to leverage the cargo routing capabilities of the NAVSUP LOC (supporting unit). NAVSUP LOC manages and controls the CRIF, which is the Navy's single source of current shipping addresses for all Navy and deployed Coast Guard ships.
4. The goals of utilizing the CRIF in support of integrating with Naval Logistics are:
  - a. To integrate policy, doctrine, business processes, technologies, and systems to optimize logistics performance in support of future operations.
  - b. To integrate, or make interoperable, the Naval Service's logistics systems and technologies to achieve interdependency in the maritime domain; to include capabilities for electronically requesting, processing, and tracking material over the last tactical mile.
  - c. To exploit current and future inventory positioning and distribution capabilities by leveraging best of breed Naval Service capabilities and maintaining partnerships with DLA, U.S. Transportation Command, and other Services.
5. From approximately C-45 through R-10, deploying naval units shall leverage the capabilities of the CRIF to streamline the resupply and sustainment distribution pipeline and eliminate redundant handling of cargo as units move from location to location while deployed.
6. Supported units shall use the CRIF for cargo routing by ensuring their TAC-2 freight addresses are loaded to the CRIF prior to deployment. Supported units shall also keep the NAVSUP LOC informed of unit locations via Fleet Freight Routing (FFR) messages or e-mail during the duration of deployment. Afloat units going ashore for an extended time (e.g. > 14 days), must notify NAVSUP LOC via FFR if the unit desires to receive inbound shipments while ashore. The use of the

CRIF as a logistics multiplier contributes to a higher state of unit readiness by reducing warfighter wait time for resupply/sustainment.

7. Supported units embarking aboard Navy ships shall also provide their DoDAACs to the ship's supply departments for inclusion in the ship's FFR messages. This will allow synchronized delivery of embarked units resupply with the assigned ship via replenishment at sea through a single naval transportation pipeline. Units operating ashore can route material to either a single static location or from location to location as the situation dictates.

8. Special distribution procedures are often in effect for forces engaged in large-scale/joint operations. Units should validate information concerning the routing of sustainment cargo through consolidation and CCP and shipments routed via worldwide express contracts with procedures in effect at the time of deployment.

9. NAVSUP LOC serves as the Navy's Airlift Clearance Authority (ACA) responsible for providing clearance or challenging requests for all Navy (and Marine aviation) material airlift shipments originating in CONUS. Commander, Marine Corps Logistics Command is the Marine Corps' ACA for Marine ground forces. Any material being shipped via air will be validated per Service criteria in place at the time of shipment. Most material designated for air shipment will be automatically validated; however, material meeting airlift clearance challenge criteria requires ACA validation.

a. Navy airlift clearance challenge criteria. Units have 48 working hours to respond to a NAVSUP LOC ACA challenge unless the shipment is pre-validated. Units may pre-validate requisitions for shipment by contacting the NAVSUP LOC ACA and requesting that material be pre-approved for air shipment. Shipping hazardous material via air requires a longer lead time due to diplomatic clearance requirements, which vary by country. The following criteria apply:

- > 50 cubic feet
- > 500 lbs
- Date of requisition > 90 days
- Transportation cost > \$4000

b. Marine Corps airlift clearance challenge criteria. The Marine Corps ACA will challenge shipments exceeding the established criteria as stated above. The ACA will send a naval message/email to units requesting movement with request to reply within 72 hours or shipment will be downgraded to surface movement. Responses must include a justification for air movement. The following criteria apply:

- > 50 cubic feet
- > 500 lbs

10. Additional Tasks

a. Supported units shall designate an action officer for all matters pertaining to the CRIF.

b. Conduct liaison with internal and external organizations to ensure that the CRIF accurately reflects unit cargo routing requirements. Continuous communication with all parties involved in CRIF management is the key to success.

13 JUN 2016

- c. Within the deployment window of C-45 to C-10, units will submit NAVMC 11718 DoDAAC Change Requests to update their DoDAACs and the CRIF.
- d. By C-15, the deploying unit will provide primary and secondary email addresses for the appropriate Service ACA to contact when an air shipment is being challenged.
- e. Afloat naval expeditionary units will maintain continuous liaison with ESG/ARG ship's supply officers to ensure that subsequent FFR messages accurately reflect unit cargo routing requirements. Once expeditionary unit DoDAACs have been added to the CRIF, these units will be tethered to the location(s) of the ships and will be included on the ESG/ARG FFR unless otherwise stated. If units do not want their cargo routed to the ships, appropriate information (location and effective dates) must be provided to the ship's supply officers and NAVSUP LOC to ensure desired cargo routing. The CRIF can be used to route TP 1, TP 2, and TP 3 material to different locations. Also, specific DoDAACs can be tied to other ships during split ARG operations.
- f. During the unit's redeployment phase (R-30 to R-10), units will submit a NAVMC 11718 to their MAJCOM DoDAAC monitor to resume routing cargo to the unit's home station.

11. Additional points of contact:

- a. NAVSUP LOC Fleet Locator:  
DSN 646-5425, Commercial: (757) 443-5425  
NIPR: nolsc\_fleet\_locator@navy.mil  
SIPR: nolsc\_fleet(space)locator@navy.smil.mil
- b. Navy Airlift Clearance Authority (NAVSUP LOC)  
(757) 443-5434 or DSN: 646-5434
- c. Marine Corps Airlift Clearance Authority Representative  
Commercial (760) 577-7875/7660, Fax: (760) 577-7643

12. Additional references: References [\(q\)](#) and [\(u\)](#).

**VOLUME 2: APPENDIX I**

**“DODAAC PROCESSES AND SYSTEMS”**

**SUMMARY OF SUBSTANTIVE CHANGES**

Hyperlinks are denoted by ***bold, italic, blue and underlined font.***

The original publication date of this Marine Corps Order (MCO) Volume (right header) will not change unless/until a full revision of the MCO has been conducted.

All Volume changes denoted in **blue font** will reset to black font upon a full revision of this Volume.

CHAPTER VERSION	PAGE PARAGRAPH	SUMMARY OF SUBSTANTIVE CHANGES	DATE OF CHANGE

**APPENDIX I**

**DODAAC PROCESSES AND SYSTEMS**

A DoDAAC is used to enable a business process in some system. There are over 40 business areas within the Marine Corps, each of which encompasses multiple business processes and systems. See the figure below.

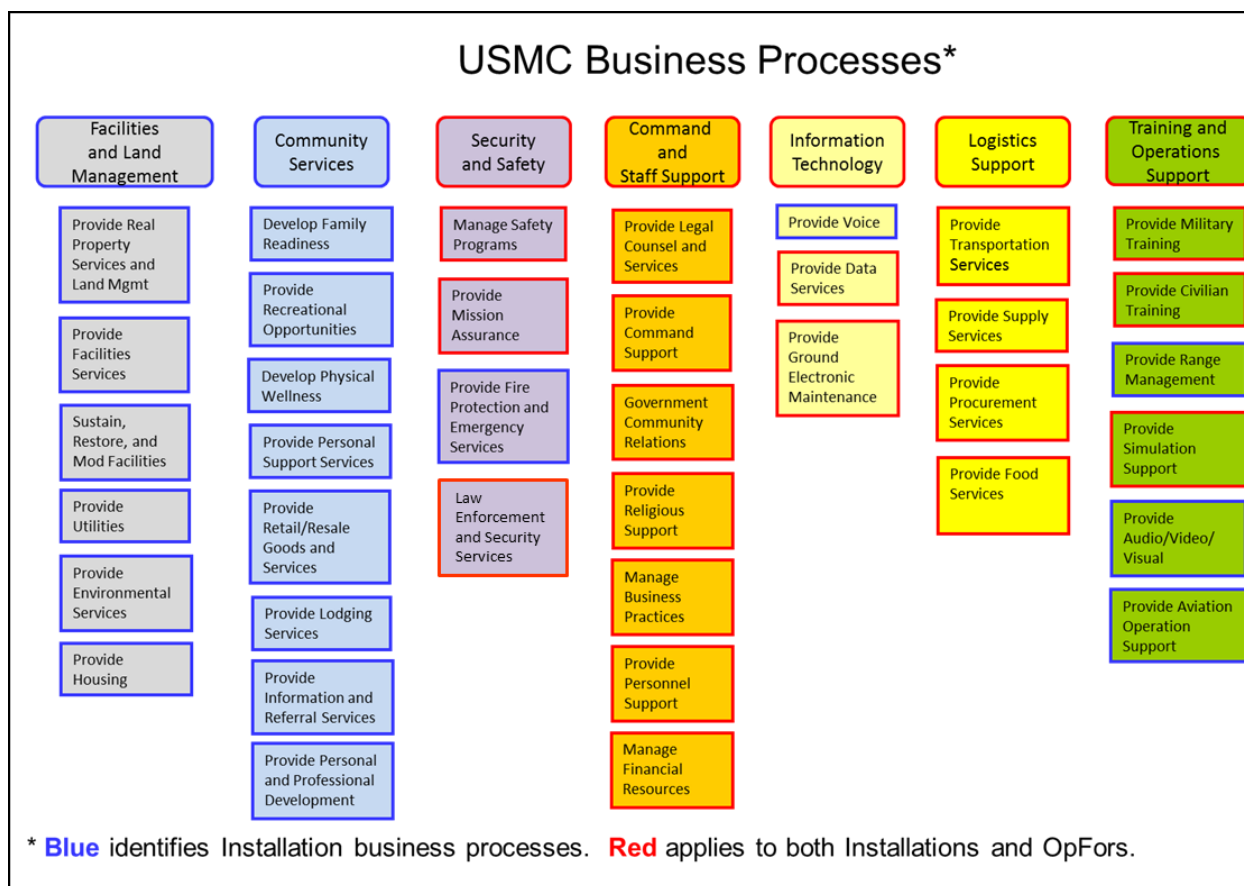

Figure I-1.—Marine Corps Functional Business Areas

The following are some major business processes and systems which use DoDAAC data. For every activity in the Marine Corps, if a mission requirement exists for the activity to perform any one of these business processes, the activity must have a DoDAAC to register in these systems, and the activity must have a commander with the appropriate capability in personnel structure to execute these business processes in accordance with statute regulations and policies.

**3-in-1 Tool** (Order, Receipt, and Payment): a technology-based solution to record and transfer data when conducting on-the-spot, over-the-counter, field purchases of supplies and non-personal services (cash and carry type purchases), which have traditionally been conducted using an SF44. The 3-in-1 tool is a small lightweight device that will capture and record purchase, payment, and receiving information including the user's receipt of goods and vendor acknowledgement of payment. The

device will automatically transfer that data to the 3-in-1 module in the Joint Contingency Contracting System.

**AMPS** (Account Management and Provisioning System): DLA's enterprise account management system used to manage access to dozens of applications. Used with MEBS to obtain maps and flight publications.

**AMS TAC** (Automated Manifest System, Tactical): a legacy application used by traffic management personnel to provide instant and automated access to manifest information regarding contents of containers and pallets.

**CASM** (Contingency Acquisition Support Model): a web-based application designed to assist individuals responsible for initiating contracting requirements in an expeditionary environment. The application identifies the documents required to initiate a contract, provides templates for the documents, prompts the user for information required to complete the documents, and routes the documents to appropriate reviewers and approvers. CASM also alerts individuals when to take action on the requirements package. CASM's output is a completed, approved contract requirements package for a forward deployed contracting office to take action.

**CCR** (Central Contractor Registration): a highly secure, single repository of vendor data used government wide. Vendor registration provides common data in one central location via a simple web application accessed by a browser. The CCR lists CAGE and other vendor information for all contractors doing business with the Marine Corps. The TAC1 of all contractor DoDAACs shall be the same as their address information listed for their CAGE in the CCR. This system has been incorporated into System for Award Management (SAM).

**CMOS** (Cargo Movement Operations System): a combat support system that automates installation cargo movement during peacetime, and deployment cargo and passenger movement during contingency operations. The Air Force is responsible for the development of this system.

**CRIF** (Cargo Routing Information File): the automated authoritative source for CONUS and OCONUS outbound cargo routing for all mobile naval units, deployed Coast Guard vessels and aviation squadrons, including components of ESG/ ARG. The CRIF, managed by Naval Operations Logistics Support Center (NOLSC), provides shipping addresses for unit's TP Codes one, two and three to DLA TS. DLA TS distributes CRIF information to government sources of supply and logistics systems to ensure automated processing of shipments to the correct location. The CRIF can be used for CONUS and OCONUS addresses, as well as ship's addresses. Any location worldwide can be loaded into the CRIF.

**DAMES** (DAASC Automated Message Exchange System): provides a communications capability that allows a DAMES customer to exchange logistics data with the US Government and the DoD logistics community. DAMES is a PC-based system providing the capability to communicate with DAAS, sending and receiving logistics transactions and narrative traffic. The MS Windows version of DAMES communicates via TCP/IP via the internet. The DAMES server manages the input and output files for DAMES users that utilize 'FTP' as their method of exchanging logistics data with the DAASC. As data is received, the server validates the format of the input file, and passes the data to the DAASC Network Control System (DNCS) for processing. As DAAS outputs data to a DAMES

'FTP' customer, the DAMES server software manages the transmission of the data to the DAMES customer site. The customer interfaces with the DAMES server via their DAMES PC software package. Customer profile information on the DAMES server is updated during DNCS file maintenance. See reference [\(z\)](#).

**DCPDS** (Defense Civilian Personnel Data System): a computer-supported system designed to improve the accuracy, responsiveness, and usefulness of data required for civilian personnel management within the Army and DoD. In DCPDS, each civilian employee has a master record reflecting over 15,000 characters of data. The database contains current, projected, and historical positions. It also contains employee personnel management data, such as education level, work experience, current grade and step, awards history, projected training requirements and completed training. Workforce analysis on a variety of topics can be provided to assist in making sound, well-informed personnel management decisions. Examples of products DCPDS products include, performance ratings and awards distribution; discipline and adverse actions taken; fill actions or separation actions taken and/or pending; current or projected retirement eligible; employees on temporary appointments, details, and promotions; employees participating in formal training programs; and employees with military recall status.

**DCPS** (Defense Civilian Payroll System): the DoD system used to pay Federal employees of DoD.

**DLMS** (Defense Logistics Management System): a process governing logistics functional business management standards and practices rather than an Automated Information System (AIS). The DLMS interprets, prescribes, and implements DoD policy in the functional areas of supply, transportation, acquisition (contract administration), maintenance, and finance. Joint committees administer the requirements of these functional areas. The DLMS provides a functional infrastructure for the establishment and maintenance of procedural guidelines required for its user community to carry out DoD logistics policy. The DLMS is authorized by reference [\(c\)](#).

**DLSS** (Defense Logistics Standard Systems): the MILS system for data exchange. Being replaced by DLMS.

**DMLSS** (Defense Medical Logistics Standard Support): the DMLSS AIS has joint interoperability requirements which directly support the DoD medical community's core mission functional areas. The focused objective of the DMLSS program is to support the Military Health System health care delivery mission by providing timely materiel, facilities, services, and information resources essential to patient care in both peacetime and wartime. The DMLSS AIS is the primary support system for all military logistics functions associated with Medical Treatment Facilities (MTF) worldwide. Critical MTF logistics functions managed include medical equipment inventories, consumable supplies management, and similar related inventory services. This program automates these critical medical logistics by standardizing hospital computer data inventory processes. This impacts the MTF by reducing the time that health care personnel must spend on routine logistics activities. DMLSS achieves integration and interoperates with other standard DoD systems such as DFAS and DLA. DMLSS is deployed to virtually all CONUS & OCONUS MTFs as well as combat and field units in support of medical logistics requirements. Other DMLSS interfaces include military theater medical information systems, other medical and non-medical AIS systems as well as financial, procurement, civil engineering, and military wholesale logistics systems.



**DoD E-Mall** (DLA Electronic Commerce Mall (or DoD E-Mall): a DLA managed website used for online procurements of commonly used items. For the Marine Corps, use of DoD E-Mall is only authorized for non-MILSTRIP requirements. Materiel that has a National Stock Number is not authorized for procurement through DoD E-Mall and must be requisitioned through the appropriate Marine Corps system. DoD E-Mall keys off of an activity's DoDAAC.

**DoDAAD** (Department of Defense Activity Address Directory): automated database of all DoDAACs.

**DoDAAF** (Department of Defense Activity Address File): database file that contains the DoDAAD.

**DPAS** (Defense Property Accountability System): a DoD property management system. It is the APSR for over 20 DoD agencies and military Services. This program is administered by OUSD AT&L, a branch of OSD. In the Marine Corps, DPAS uses DoDAACs to establish accounts.

**DRRS-MC** (Defense Readiness Reporting System - Marine Corps): designed and implemented on 30 April 2010, DRRS-MC is the Marine Corps' readiness reporting system that fulfills reference [\(l\)](#) responsibilities and provides readiness information for congressional testimony, quarterly readiness reports to congress, joint combat capability assessments, and the Commandant's Planning Guidance. DRRS-MC captures both unit resource and MET/mission assessments of units designated to report readiness on both core and assigned missions. Force structured units (units established by MCBul 5400) designated as readiness reporting units in DRRS-MC use TFSMS UICs to report readiness on core and assigned missions. When applicable, units not residing in TFSMS (ad hoc/provisional units) designated to report readiness in DRRS-MC use DC PP&O POR UICs to capture the readiness of these units in DRRS-MC.

**DTS** (Defense Travel System): a fully integrated, automated, end-to-end travel management system that enables DoD travelers to create authorizations ( TAD travel orders), prepare reservations, receive approvals, generate travel vouchers, and receive a split reimbursement between their bank accounts and the Government Travel Charge Card vendor. The Defense Business Transformation Agency (BTA) has program (technical) oversight of DTS and the Defense Travel Management Office, OUSD (P&R) has functional oversight.

**DTTS** (Defense Transportation Tracking System): provides electronic tracking of shipments while enroute and increases security and response capability in the event of accident or incident. It is DoD policy to track all Security Risk Category (SRC) I through IV munitions shipments using Satellite Motor Surveillance Service (SM). Shipments of Uncategorized Division 1.1 through 1.3 munitions will use SM at the option of the DoD shipper service headquarters. The rates charged by munitions carriers for SM will be expressed as a separate accessorial charge and will be considered with other line haul charges to determine the overall low rate for rating and routing purposes under references [\(q\)](#), [\(v\)](#) and [\(w\)](#).

**EDA** (Electronic Document Access): part of the Marine Corps' paperless acquisition portfolio, EDA is a joint repository used by the program management, finance, disbursing, contracting, industry trading partners, other federal agencies, and the logistics community to store and manage common documents. EDA has been undergoing a transformation since 2008 to store and manage procurement data standard (PDS) compliant contract data as well as historic PDF files and key elements of the



electronic data interchange (EDI) transactions. This allows EDA to present contract data in a standard format regardless of which contract writing system generated the contract transaction. In January 2011, EDA implemented a management reporting system capability to enable greater search functionality of contract data, and to facilitate downloads of this data to industry, legacy and future contract writing systems, and any other system that consume contract award data. Combined with data from the Federal Procurement Data System (FPDS), this integrated data environment enables custom extracts of data to a myriad of other functional systems. EDA is a critical capability for the contract writing and administration environment. Therefore, EDA is a mandatory DoD system for the following:

- Master repository for unclassified DoD contracts, orders and modifications in accordance with reference (q). Classified environments are encouraged to mirror the EDA data environment to ensure data integrity can be achieved across the department.
- In accordance with reference (x), all contracting officers are required to have an EDA account. This ensures that all contracting officers have access to contract deficiency reports on their own contracts, and have access to ordering instruments and useful examples from other offices. The DPAP is partnering with the EDA program office to explore search tools for identifying examples of contracts for similar efforts.
- To ensure timely and accurate reporting, DPAP also uses EDA data to scorecard contract action reporting to FPDS.
- To enable data capture of the required contractor delivery dates in support of contractor performance measurements in Past Performance Information Retrieval System – Statistical Reporting at the DoD enterprise level.

**E-MIPR** (Electronic Military Interdepartmental Purchase Request): a web-based application that enables the transmission of MIPR Form 448-1 & 448-2 using B2B technologies. The eMIPR™ web application runs in the .MIL domain in a secure 128-bit encrypted environment. It makes the process of MIPR creation, acceptance, tracking, and management efficient, accurate and secure.

**EPLS** (Excluded Parties List System): a web application that uses B2B technologies to electronically create, send/receive, and maintain up-to-date status of MIPR (Form 448-1 / Form 448-2) documents. The eMIPR™ web application runs in the .MIL domain in a secure 128-bit encrypted environment. It makes the process of MIPR creation, acceptance, tracking, and management efficient, accurate and secure.

**FAS** (Fuels Automated System): most of the fuel obtained to operate vehicles, generators, etc. is obtained from the Defense Logistics Agency-Energy (DLA-E), a subordinate command of DLA. DLA-E controls all fuel operations for all DoD agencies. Whether in garrison or deployed, the fuel farm or pumping stations are normally DLA-E owned. A Voyager fuel card or Fuel Key is required by activities using the fuel farm. This is based on the type of pumps used at the installation. The Voyager card should be accepted at commercial fuel stations. It contains the unit's DoDAAC which is used in the supplementary address field of the record used within the Material and Services Financial Information Pointer Cross Reference Table (Table 030) to process fuel charge transaction in SABRS. The Fuel Key is electronically coded with a unique serial number associated to the

activity's DoDAAC and Fund Code. The fuel card or key information is entered into FAS and used for monthly billings to consumer activities in the form of an IDB. The IDBs are processed in accordance with MILSBILLS standards and will have Document Identifier Code (DIC) beginning with "FJ."

Each time the card is used at a fuel farm, FAS creates an electronic record of the purchase and passes this transaction to SABRS. SABRS uses Table 030 to obtain the required financial code information to post the fiscal obligation transaction.

If a match for the MAC and DoDAAC in the supplementary address field are found, the incoming record is linked to fiscal data element information and a commitment, obligation and expense transaction (COE) is posted in SABRS with a system identification code of BSME. The monthly IDB processed will "marry up" with the COE record in SABRS based on the transaction's MILSTRIP document number.

FAS are a "purple" DoD system. If a command's financial data is not entered in this system and associated with the fuel card or key, SABRS will not receive a record to process the obligation for fuel charges; however, the Marine Corps will still get a billing based on the DoDAAC on the card or key.

Key process and management internal control checks are:

- Ensuring that FAS is updated with correct data elements (i.e. DoDAAC, Fund Code, etc.) to ensure an electronic transaction is passed to SABRS to commit, obligate, and expense fuel purchases.

- Ensuring that SABRS is receiving electronic records from FAS for processing, and that SABRS is receiving IDBs (at least monthly) for previous FAS purchases.

- Ensuring that Voyager cards are only being used to purchase fuel for authorized vehicles and that only authorized personnel are allowed to check the cards out for use.

**FedReg** (Federal Register): the BPN was implemented by DoD in 2003 to identify federal agencies and DoD activities that have requisition authority to enter into agreement with one another for the acquisition of, or provision for, goods and services. Activities must identify themselves with a unique BPN on all intra-governmental transactions. All BPNs must be registered in the FedReg via the DoDAAD. The BPN for DoD activities is a nine-character, alpha-numeric identifier consisting of "DoD" followed by the six-character DoDAAC (e.g., "DoD" plus "M67353" is a BPN of "DoDM67353"). The FedReg BPN is loaded automatically from the DoDAAD; consequently, proper DoDAAC assignment is critical to maintaining proper management control over requisition authority. FedReg is being replaced by SAM.

**FPDS-NG** (Federal Procurement Data System - Next Generation): the Office of Federal Procurement Policy, reference (b) requires the administrator for Federal Procurement Policy to establish a computer-based FPDS for collecting, developing and disseminating procurement data to Congress, the Executive Branch, and private sector. The FPDS Program Management Office (FPDS PMO) within the Office of the Integrated Acquisition Environment (IAE) oversees the operation of the FPDS-NG while GSA's contractor operates and maintains the system. Executive departments

and agencies are responsible for collecting and reporting data to FPDS-NG as required by FAR. The Federal Government uses the reported data to measure and assess the impact of Federal procurement on the nation's economy, the extent to which awards are made to businesses in the various socio-economic categories, the impact of full and open competition on the acquisition process, and other procurement policy purposes. FPDS-NG contains data that the Federal Government uses to create recurring and special reports to the President, Congress, the Government Accountability Office (GAO), Federal executive agencies and the general public. FPDS-NG is part of the Marine Corps' paperless acquisition portfolio.

**GPC** (Government Purchase Card): the GPC Program (also known as the GSA SmartPay Program) provides charge cards to agencies/departments throughout the U.S. Government. The GPC Program is intended to streamline the small purchase and payment process, minimize paperwork, eliminate impress fund transactions, and to simplify the administrative effort associated with procuring goods and services under the micro-purchase threshold. The GPC Program is established using master contracts negotiated with national banks (e.g., Citibank, JP Morgan Chase, and U.S. Bank).

**GCSS-MC** (Global Combat Support System - Marine Corps): the system was designed to operate within the Marine Corps technical infrastructure and incorporates a seamless logistics information system, integrating supply and maintenance functionality through a common user interface and relational database. GCSS-MC uses an enterprise resource planning solution – Oracle® 11i eBusiness Suite software – and enables numerous organizational changes and redesigned supply and maintenance procedures. GCSS-MC provides the foundation for an energetic multi-year, multi-phased logistics modernization program that will dramatically enhance the model for warfighter support. Unlike legacy supply systems, GCSS-MC uses the TFSMS UIC as the identifier for establishing a customer account. The UIC is also used as the principal identifier for accountability of end items within the system. The DoDAAC is associated to the customer account and is used as the identifier for conducting business across DLMS (i.e., requisitioning, etc.). It is therefore key that the relationship between UICs and DoDAACs be maintained current within the DoDAAF to enable this relationship.

**GRSC** (Garrison Retail Supply Chain): consists of a collection of retail ServMart stores located on Marine Corps installations (Marine Corps Logistics Base (MCLB), Albany, Georgia and Barstow, California; Marine Corps Base, Camp Pendleton, CA; Marine Corps Base, Camp Lejeune, NC; Marine Corps Base, Quantico, VA; Marine Corps Base, Camp Butler, JA; Marine Corps Base, Kaneohe Bay, HI). These ServMarts provides support to installations and its tenant activities with services, office supplies, commercial industrial products (i.e., select hand tools, cleaning supplies, etc.) and maintenance repair and operations supplies in direct support for installations and tenant activities.

ServMarts supported under the GRSC do not replace the requisition process for supply system items; Supply Class with dedicated systems of record to include, but not limited to Class V, Class VII, Class VIII and Class IX. Requirements for system items will be requisitioned via the appropriate ADS in order to build supply demand data history. However, commercial readily available items of a non-military specific nature may be procured via the ServMarts and demand data provided to the SMU as required.

**HMMS** (Hazardous Material Management System): a DoD system used for managing hazardous materials and waste compliance reporting.

**INFADS** (Internet Navy Facilities Assets Data Store): the official Navy database used to track custody and control of Class I (land) and Class II (facilities) property. Commander, Naval Facilities Engineering Command is the administrator of INFADS and the custodian of the Navy's official Real Property Inventory (RPI). MCICOM is the Marine Corps' manager of Real Property.

**JDRS** (Joint Discrepancy Reporting System): used by Marine Aviation activities to submit Product Quality Deficiency Reports (PQDRs), EIS, and Technical Publication Deficiency Reports.

**JOPES** (Joint Operational Planning and Execution System): the Chairman of the Joint Chiefs of Staff joint planning system. It covers the planning spectrum from the National Command Authorities (NCA) through the Chairman, to the COCOMs and the joint task force commanders. JOPES governs all aspects of conventional joint military operations planning and execution. It is the tool used by all echelons of planners and operators to speak a commonly understood language. JOPES furnishes joint commanders and war planners at all levels with standardized policies, procedures, and formats to produce and execute a variety of required tasks (i.e., planning, execution and deployment (time-phased force and deployment data [TPFDD]) management)). JOPES is not simply a computer system. It includes automated data processing (ADP) support for planners and commanders by providing both hardware (computers) and software (programs) to facilitate joint operation planning and execution. JOPES software applications support a variety of planning and execution functions. Together, the computer hardware and software systems assist planners to develop detailed deployment requirements, estimate logistics and transportation requirements, assess transportation feasibility, prioritize and track deployment status during execution, and refine deployment requirements and monitor the deployment. JOPES is the principal system within the DoD to translate NCA policy decisions into the joint COCOMs air, land and sea operations. It does this by precisely defining DoD war planning and execution policies, designating specific procedures and formats, and providing ADP support to convert NCA decisions into joint operation plans.

**LMARS/CWT** (Logistics Metrics Analysis Reporting System/Customer Wait Time): this system is populated with information from the MILSTRIP and MILSTRAP transactions that flow through the DAAS. LMARS/CWT reports response time within any of the 12 nodes of the logistics pipeline. All reporting timeframes are in terms of days. LMARS/CWT maintains historical data since its inception in February 1997. Standard reports are available (via the web also) on a monthly basis.

**MDSS II** (Marine Air-Ground Task Force (MAGTF) Deployment Support System II): a standalone system used by Marine Corps operating forces to support Force Deployment Planning and Execution (FDP&E). It is the database and interface hub for unit deployments. Through the use of extensive reference files, the system provides actual data to JFRG II to create an executable TPFDD. It reads/writes standard MSL, and active Radio Frequency Identification tags. It collects and formats data for transmission to the ITV server and exchanges information with Marine Corps, other service and joint logistics, movement and distribution systems.

**MEBS** (Mapping Enterprise Business System): a DLA system used to obtain maps and flight publications which are shipped free issue to an activity's DoDAAC. Units that have subscriptions for maps/flight pubs via MEBS should either be requisitioning DoDAACs (00) or Free Issue (06). Squadrons that do not have their own requisitioning DoDAAC may often obtain a 06 DoDAAC solely for subscribing through MEBS.

**MILSBILLS** (Military Standard Billing System): the system provides data elements, codes, standard mechanized procedures, and formats to be used for billing, collecting and related accounting for sales of materiel and services prescribed for the Inter-fund Billing System.

**MILSCAP** (Military Standard Contract Administration Procedures): prescribes uniform procedures, rules, data elements, codes, formats, and time standards concerning the interchange of contract related information between and among DoD Components. Being replaced by DLMS. See reference [\(p\)](#).

**MILSTAMP** (Military Standard Transportation and Movement Procedures): establishes uniform procedures and documents for the generation, documentation, communication and use of transportation information, thus providing the capability for control of shipments moving in the DoD transportation system. The MILSTAMP regulation (DoD 4500.32R, Vols I and II) has been incorporated into Part II (Cargo Movement) of reference [\(q\)](#). The former MILSTAMP provisions have been realigned with the appropriate subject matter within DTR Part II.

**MILSTRAP** (Military Standard Transaction Reporting and Accountability Procedures): prescribes uniform procedures for recording inventory management data passed between elements of a single Service or Agency distribution system or between the various distribution systems of the DoD. The forms, formats, and codes provide for standard transaction reporting and accountability procedures for item accountability and financial inventory of DoD materiel. The prescribed codes are mandatory for inter- and intra-DoD Component use when data are interchanged among distribution system elements. See reference [\(y\)](#).

**MILSTRIP** (Military Standard Requisitioning and Issue Procedures): prescribes uniform procedures, data elements, codes, formats, forms and time standards for the interchange of logistics information relating to requisitioning, supply advice, supply status, materiel issue/receipt, lateral redistribution, and materiel return processes. The procedures govern the interchange of information for all materiel commodities between supported activities and supply control/distribution systems of the DoD. See reference [\(f\)](#).

**MOCAS** (Mechanization of Contract Administration Services): used for the management and payment of complex contracts including multi-funded contracts and line items. It provides support for source acceptance of contracts requiring higher level or specialized quality assurance requirements, administration of government property furnished to contractors, and management of contractor business systems and contract closeout. MOCAS provides DCMA with an enterprise source of contract management data for all its military service and defense agency customers. Payments from MOCAS account for approximately 60% of the dollars paid to vendors by DoD.



**MOWASP** (Mechanization of Warehousing and Shipping Procedures): the Marine Corps ICP and remote storage activity (RSA) storage and distribution system. It is one of five most critical legacy logistics systems used by MARCORLOGCOM. Operational users at the Fleet Support Centers Albany, GA., and Barstow, CA. use MOWASP to process the following transactions: Due-In, Receipt, Due Verification, Material Release, Material Release Advice, Physical Inventory, Demand, Storage Item Correction, and Inventory Adjustments. MOWASP obtains its information via DAAS or from direct feeds from the SCS or Technical Data Management System (TDMS). It allows MARCORLOGCOM logistics systems the ability to implement DLMS. DPAS will replace the warehouse components of MOWASP.

**MUMMS** (Marine Corps Unified Material Management System): manages the in-stores element of the Marine Corps' inventory which is under central inventory management control. The system incorporates all standardized requirements of DoD. It is compatible with DLA, GSA, and other military Services through the use of standardized formats and languages. The in-stores element consists of the following organizational components: ICP, MCLB, Albany, two RSA's, and Direct Support Stock Control (DSSC) activities. The administrative tasks and functions available in MUMMS are organized into 15 subsystems operated as one integrated system from the ICP through a large-scale computer program. The subsystems are interrelated and data in each subsystem are available to the others for use. The subsystems fall into three general areas. Two areas, supply/financial and technical, pertain to the functions at the ICP. The third area pertains to RSA functions. There are eight subsystems in the supply/financial area. These are concerned primarily with inventory control, accounting, procurement, budget, and supply management reports. The five subsystems in the technical area perform such functions as provisioning, technical data, war reserve, data control, and applications. The remaining two subsystems deal with the RSA functions of MOWASP and DSSC. A brief summary of each of the 15 subsystems follows:

a. Stores Accounting Subsystem (SS 04)

The Stores Accounting Subsystem is designed as an automated operation to record and accumulate all data required for financial analysis of inventory movement, and to control and account for cash resources as well as financial inventory balances. From the input data, current and timely management and financial control reports are produced to support decision making and for financial control actions under the budget process. This system receives transactions which affect the Marine Corps Stock Fund and Marine Corps Appropriation Stores Account Master Inventory and Direct Support Stock Control records, computes the dollar value of the transactions, and updates the store's inventory balance records. These transactions are accumulated into various files to be used for the preparation of management reports, financial reports, budget reports, and reconciliation of supply and fiscal transactions.

b. Automated Procurement Subsystem (SS 05)

The Automated Procurement Subsystem provides semiautomatic purchase requests for commercial purchases generated by the Inventory Control Subsystem. In addition, it provides previous procurement history and other data necessary for the buyer to select bidders, evaluate responses, and process the award.

c. Mechanization of Warehousing and Shipping Procedures (SS 06)

The MOWASP Subsystem is an automated procedure for shipment of supplies, receipts, in-storage operations, and preparation of management reports. This subsystem is required due to the adoption of the MILSTRIP and MILSTAMP automated procedures. It covers the receiving process, the issue and shipment process, the preservation and packaging process, operation inspection of technical items, and space reporting.

d. Direct Support Stock Control Subsystem (SS 07)

The DSSC Subsystem is designed to record and accumulate all data required for routine record keeping; requisitioning, reporting to the Inventory Control and Stores Accounting Subsystems; and maintaining history. The accounts within the subsystem are: self-service centers; retail clothing outlets; subsistence accounts; ammunition accounts; petroleum, oil, and lubricant ; and separate individual clothing accounts.

e. Technical Data Management Subsystem (SS 08)

The Technical Data Management Subsystem is designed to capture and record the elements of technical and management data related to items of supply and/or production. The detailed procedures of this subsystem outline specific functions and responsibilities necessary to maintain pertinent files of data related to items of supply and production and provide a means of ready retrieval of stored data through the use of inquiry techniques. The subsystem provides notification of cataloging and management data changes to Marine Corps organizations and certain DoD activities; interfaces with and provides information to, other materiel management systems; and is compatible with DoD/DLA materiel management systems.

f. Applications Subsystem (SS 09)

The Applications Subsystem provides an automated capability to maintain certain elements of current management data for all preferred stock numbered items in the supply system. It computes retention levels for special item categories to ensure protection of assets. It is also the source for the Marine Corps Stock List, SL-6; and provides data for the maintenance of other stock lists.

g. Provisioning Subsystem (SS 10)

The Provisioning Subsystem ensures that initial spares, repair parts, special tools, test equipment, and support equipment required for initial support of new items are procured and protected from general issue and distributed in a timely basis to appropriate organizations. This subsystem, through other subsystems, enables supply support with Integrated Materiel Managers (DLA/GSA); updates/establishes application files; causes new items to be entered into the Inventory Control Subsystem; and prepares Marine Corps Stock List, SL-4.

h. War Reserve Subsystem (SS 11)

This subsystem develops the record of mobilization (D-day) materiel requirements authorized for acquisition in the Marine Corps. Requirements, established by various withdrawal plans, are processed routinely in the Marine Corps inventory management systems to ensure the protection of assets. The records developed by this subsystem provide input to AAO. Upon execution of a withdrawal plan, this subsystem generates the necessary transactions to the appropriate Marine Corps inventory management system (wholesale/retail) to cause the release of required materiel. The overall concept is tailored to provide immediate response to the MAGTF materiel support requirements at D-day or any "short of war" situation.

i. Special Programs Subsystem (SS 15)

The Special Programs Subsystem is intended to support those programs special in nature which cannot be routinely controlled or processed by other subsystems within MUMMS. It addresses those programs, regardless of size, which involves considerable interface with two or more subsystems, to more clearly portray an overview of the required actions or functions.

j. Supply Management Information Subsystem (SS 16)

MUMMS is a very broad system. A system of this magnitude needs a focal point for collecting useful data from all of the subsystems and for collating it into meaningful reports for management personnel. The Supply Management Information Subsystem is designed to fulfill this vital role within MUMMS. This subsystem will incorporate all of the processes and procedures necessary to support this centralized materiel management approach. Each subsystem design includes processes for generating prescribed output to this subsystem. All of this data will be collected in the SS 16 data bank, from which it will be retrieved for integrated processing on schedule.

k. Allotment Accounting Subsystem (SS 17)

The Allotment Accounting Subsystem is a manual/mechanized system which records funding data from the time the ICP initiates a requisition until its funds are liquidated. This subsystem provides up-to-date information on funds allotted to the ICP on an accelerated basis, including the recording of necessary funding data from computer-generated buy recommendations, manually generated buy recommendations, direct delivery buy notices, and MILSTRIP requisitions. In addition, it provides techniques for monitoring funds to ensure that over commitments/obligations do not occur. The allotment file and other associated files furnish all necessary data for the preparation of reports for local management and for submission to CMC.

**NALCOMIS** (Naval Aviation Logistics Command Management Information System): a component of NAMP, NALCOMIS provides a modern, real time, responsive, computer based management information system. The three objectives of NALCOMIS are to increase aircraft readiness by providing local maintenance and supply managers with timely and accurate information required in their day-to-day management and decision making process, reduce the administrative burden on the fleet, and improve the quality of reported data.



**NAMP** (Naval Aviation Maintenance Program): the objective of the NAMP is to achieve and continually improve aviation material readiness and safety standards established by the CNO/COMNAVAIRFOR, with coordination from the CMC, with optimum use of manpower, materiel, facilities, and funds. COMNAVAIRFOR aviation material readiness standards include:

- a. Repair of aeronautical equipment and materiel at that level of maintenance which ensures optimum economic use of resources.
- b. Protection of weapon systems from corrosive elements through the prosecution of an active corrosion control program.
- c. Application of a systematic planned maintenance program and the collection, analysis, and use of data in order to effectively improve materiel condition and safety.

**NSWC Small Arms Registry**: Naval Surface Warfare Center (NSWC) Crane is the Marine Corps Component Registry that serves as the ADS for full lifecycle asset tracking through serialization control for small arms/light weapons in accordance with reference (z). NSWC Crane, Indiana manages the Marine Corps Serialized Small Arms Accountability Program, which meets DoD serialized small arms/light weapons reporting and property accounting requirements, provides the means for timely and accurate tracking of each small arm's status, and augments established security procedures. The registry establishes accounts for organization's serialized small arms by way of the DoDAAC.

**OIS** (Ordnance Information System): a vertically integrated, web-enabled collection of user applications, internal processes, and report generators operating against a distributed Oracle® relational database. The Joint Ammunition Standard System was terminated leaving the Services to find a solution. Marine Ammunition Accounting Reporting System was a batch process system that would need to be modernized to support "real time" asset visibility as directed in the CINC 129 requirements document. An analysis of alternatives was conducted and the decision was made to partner with the Navy Ammunition Logistics Center to develop a Naval system to manage supply Class V ammunition. The joint solution is the Ordnance Information System (OIS) which brings together functionality of many legacy systems into a web-based, shared data environment.

**One Touch** (Navy One Touch Support): Navy online requisitioning portal which interfaces with DAAS via the DoDAAC.

**ORCA** (Online Representations and Certifications Application): a Federal mandate for vendors as published in references (z), and (aa). ORCA was developed as part of the BPN, which is a component of the IAE E-Gov initiative. ORCA provides the SAM with data for registered vendors of the Federal government. The mandate requires that each Service:

- a. Provide representations and certifications electronically via the BPN website (orca.bpn.gov/) thus reducing the administrative burden on vendors who have been submitting the same representations and certifications repeatedly for various solicitations.
- b. Maintain current representations and certifications on an annually basis.

c. Make changes that affect only one solicitation by completing sections of specific provisions that are required by the FAR, included in the solicitation.

**PBDD** (Program Budget Development Database): the Marine Corps Program Objective Memorandum (POM) is developed through the PBDD. The key to the PBDD is the Marine Corps Programming Code (MCPC). All initiatives and funding tracks for Major Allotment Recipients are associated with a MCPC. HQMC P&R is the functional manager of the PBDD. The PBDD uses DoDAACs to identify commands and must be reconciled annually against the DoDAAD for accuracy.

**PBIS** (Program Budget Information System): the Navy's primary information system for developing and submitting the DON's long range financial plan (POM) and budget to OSD, and for allocating the funds appropriated and monitoring their execution. This includes the Marine Corps. PBIS consists of a server complex in the Pentagon on the Navy Marine Corps Internet, and a backup site at a secure location. PBIS provides functionality that allows users to create, modify, query, and generate reports on DON POM and budget data.

**PDREP** (Product Data Reporting and Evaluation Program): the DON program that supports requirements regarding the reporting, collection and use of supplier performance information identified in the Code of Federal Regulations, FAR, Defense Federal Acquisition Regulation Supplement (DFARS) and Navy regulations. PDREP supports Navy management of the supply chain ensuring first time quality and on-time delivery of materials for both critical and non-critical applications. It promotes continuous process improvement for increased materiel readiness and decreased deficiency issues, providing an overall cost savings to DoD and the Navy. The program is sponsored by the Office of the Assistant Secretary of the Navy Research, Development and Acquisition ASN (RD&A) and is the designated SECNAV PDREP program authority. Within ASN (RD&A), the DASN Expeditionary Programs and Logistics Management (ELM) is the primary office of responsibility and provide program guidance and policy regarding PDREP and its use. SECNAV Instruction 4855.3 is the foundation of the PDREP program and establishes requirements for all DON Activities to report supplier performance information in PDREP. The PDREP (AIS) is the single authorized DON database used to record, collect, retrieve and analyze supplier performance data. PQDR) discrepancies (Supply Discrepancy Reports - SDR), Receipt Inspection (Material Inspection Results - MIR), Contract Delivery Performance (Contract Award Data – CAD), Supplier Audits, Supplier Survey Data, Non-Conforming Materials, Premature Material Failures, Naval Bulletins, Special Quality Data and other relevant supplier information. The PDREP AIS supports the documentation, storage and retrieval of multiple record types displaying supplier product and performance information. It is Item Unique Identification (IUID) compliant providing automated data retrieval from the IUID registry for easier reporting of Unique Item Identifier materials. The program also provides an AD HOC feature that allows for creation of unique reports, designed specifically by the individual user.

**PQDR** (Product Quality Deficiency Report): the cross-Component process that provides quality deficiency data to activities responsible for design, development, purchasing, production, supply, maintenance, and contract administration so that action may be initiated to determine cause, take corrective action, and prevent recurring deficiencies. The PQDR is used to report deficiencies occurring in major weapon systems, secondary/consumable/repairable items, spare and repair parts, government-owned products used during development and testing, and items supplied as

government-furnished property, to include warranted, Contractor Logistics Support, commercial off-the-shelf (COTS), and Marine Corps Common Hardware Suite items. Any individual may report a product quality deficiency. An individual/Activity that discovers defective materiel and submits a PQDR is known as the originator/originating point. Even if a deficient item is useable, the deficiency must still be reported. PQDR uses ship-to DoDAACs like “in boxes” as a means of facilitating transmission of information within the system.

**PR Builder** (Purchase Request Builder): part of the Marine Corps’ paperless acquisition portfolio, PR Builder is the front-end of the Marine Corps acquisition process. It is used by Marine Corps commands to electronically create, route for approval, and apply funding to purchase requests (PRs), funding documents (FDs), and miscellaneous payments (MiscPay). PR Builder reports, near real-time commitment transactions to SABRS. PR Builder also interfaces with the Standard Procurement System (SPS) to provide the contracting office with contract information associated appropriation data. MARADMIN 444/12 mandated the use of PR Builder for all Marine Corps Inter/Intra Government Transactions effective 1 October 2012. PR Builder contains DoDAACs for all Marine Activities that are authorized to requisition (DoDAACs w/authority code 00).

**RAMP** (Reportable Asset Management Process): an Air Force system that was adopted by the Marine Corps to replace the functionality of the legacy MUMMS Subsystem for Controlled Item Management, known as Subsystem 13 (SS 13). RAMP interfaces with TFSMS for allowances and end item stratification by way of TFSMS Type Support Codes and Command Designator Codes (a.k.a. MAJCOMs).

**SABRS** (Standard Accounting Budget and Reporting System): the official accounting system for the Marine Corps designed to meet fiduciary standards established by the GAO, OMB, United States Treasury Department, and DoD. SABRS accounts for all Marine Corps funds throughout the life of the appropriation. Normally, this will include the year authorized to incur new obligations and five subsequent years to complete receipt and expenditures on established undelivered orders. SABRS uses DoDAACs to identify its various commands and establishes a hierarchy of MRIs, ARIs, SRIs, WCIs, and AACs that reflect an operational command and control based on funds distribution. Table 208 of SABRS must be maintained accurate with the DoDAAD on an as occurring basis to ensure that all Authority Code 00 DoDAACs in SABRS are reflected in the DoDAAD, and vice versa (except for NAF activity DoDAACs). HQMC I&L (LPC) and P&R (RFA) ensures constant dialog between the CSP and the SABRS Table Load Manager to ensure that accuracy is maintained.

**SAM** (System for Award Management): a Federal Government owned and operated free web site that consolidates the capabilities in CCR/FedReg and ORCA. Future phases of SAM will add the capabilities of other systems used in Federal procurement and awards processes.

**SCS** (Stock Control System): an Air Force system that was fielded at Marine Corps Logistics Command in 1995 to replace legacy subsystems of MUMMS for ICP accountability of equipment, supplies and materiel. The system itself is comprised of a 3270 mainframe online portal and a mid-tier web-based application which provides users with capabilities for materiel management that include technical research, finding parts, reading item manager notes, and getting status of requisitions sent to Marine Corps ICPs. The SCS website opens in the Asset Inquiry page but the SCS program can also do requisition inquiries and part number inquiries.

**SPS** (Standard Procurement System): part of the Marine Corps' paperless acquisition portfolio, the SPS is a software suite providing front-office business services to acquisition professionals in the United States DoD. SPS is an outgrowth of the DoD corporate information management (CIM) initiatives in the early 1990s and provides standard business processes and data management across disparate acquisition communities, including:

- Posts, camps, and stations
- Inventory Control Points
- Major Weapon Systems
- Contingency contracting

**STORES** (Subsistence Total Order and Receipt Electronic System): a PC-based system that enables the Military Services to send requirements to multiple vendors via EDI. STORES are based on accounts which are represented by DoDAACs. It must be reconciled with the DoDAAD on an as occurring basis to ensure the accounts contained in the system have valid DoDAACs. With the touch of a button, a cook in the dining hall can have an entire grocery list automatically ordered to different vendors for milk, bread, and other grocery items. STORES uses EDI transactions for price and item information, orders, receipts, and trading partner profiles among Defense Supply Center Philadelphia, customers, and vendors. It also sends requirements for produce to the Defense Subsistence Offices using EDI. All STORES price, item, and receipt information passes to the customer's food management system to adjust inventory records. The STORES Management Information System (MIS) serves as the engine behind the system. The MIS is the repository of all catalog, order, and receipt information worldwide. It is a network that creates and distributes catalogs from the MIS as EDI transactions. Copies of orders and receipts transmitted from each of the STORES PCs flow to the MIS, establishing financial records and producing reports. The Joint Food Management System, a DLA-financed system, is planned to replace STORES and the Service's food management systems. It will incorporate all menu planning, recipes, replenishment, inventory, head count, budgeting, and accounting functions performed by legacy systems, in addition to the catalog, order, receipt, and management information currently provided by STORES. The joint system will be accessible via the Web from any computer. It will utilize commercial off the shelf software, with some customization to address the requirements of a system that must operate in peacetime and in war.

**STRATIS** (Storage Retrieval Automated Tracking Integrated System). STRATIS was originally developed as the stand alone warehouse management system for the Marine Corps. The STRATIS application is fielded at six locations around the world and is in the Operations and Support phase of its lifecycle and requires IT support services to meet its day-to-day supply mission requirements.

**TAMIS** (Total Ammunition Management Information System): serves as the Marine Corps standard for forecasting training ammunition at Marine Corps and other training facilities. TAMIS is used to provide training ammunition from an ASP to its customers. TAMIS user accounts are manually created using DoDAACs. As such, the DoDAACs contained in TAMIS are not automatically updated as changes occur within the DoDAAD. If a unit changes location (due to unit rotation) and accepts a new DoDAAC for the command, appropriate updates must be made within TAMIS and the DoDAAD to ensure proper accountability and support of ammunition at the new location.

**MCTFS** (Marine Corps Total Force System): an electronic system that contains personnel and pay data of all active and reserve Marine Corps personnel, and personnel data of retired Marine Corps personnel. The system also contains mission-essential personnel information for selected civilian employees and contractors affiliated with the Marine Corps. Career data created prior to 1988 was migrated from legacy personnel systems. The system contains five-digit RUCs which are used for reporting, and MCCs which are used for personnel assignments. The system maintains personnel and pay information for Marine Corps personnel including, but not limited to, the following:

- Name, rank/grade, SSN, date of birth, citizenship, marital status, home of record, dependents information including their SSNs, records of emergency data, enlistment contract or officer acceptance form identification, duty status, component code, population group, sex, ethnic group, duty information, duty station/ personnel assignment, unit information, security investigation date/type, leave account information, separation document code, test scores/information, language proficiency, military/civilian/off-duty education, training information to include marksmanship data, physical fitness data, Swim qualifications, military occupational specialties, military Skills and schools, awards, combat tour information, aviation/pilot/flying time data, reserve drill information, reserve unit information, lineal precedence number, limited duty officer/warrant officer footnote, TAD data, overseas deployment data, limited medical data, conduct and proficiency marks, years In service, promotional data, weight control and military appearance data, commanding officer assignment/relief data, joint Military Occupational Specialty data, and related data.

- Pay data includes leave and earnings statement which may include base pay, allowances, allotments, bond authorization, health care coverage, dental coverage (if applicable), special pay and bonus data, federal and state withholding/income tax data, FDIC contributions, Medicare, Social Security, SGLA deductions, leave account, wage and summaries, reserve drill pay, reserve AT pay, and other personnel/pay management data.

**TFSMS** (Total Force Structure Management System): a web-enabled workflow application that integrates capability development processes across the Marine Corps' enterprise to support the warfighter in terms of manpower and equipment requirements. TFSMS is the Marine Corps' ADS for TO&E, UICs, billets, unit equipment allowances, individual equipment allowances, TAMCNs, all equipment characteristics, and AAO. TFSMS was fielded in July of 2005 and replaced the separate functions of manpower requirements from Table of Manpower Requirements and equipment requirements and characteristics from Logistics Management Information System .

**TPPS (PowerTrack)** (Third Party Payment System): a commercial off-the-shelf (COTS), third-party payment system used by DoD for transportation payment processing. PowerTrack provides real-time information exchange through the World Wide Web and bridges the gap between DoD and carrier information systems. PowerTrack collects shipment and financial data from both shippers and carriers in a single electronic document and makes data available over the internet to all parties. PowerTrack is used to reduce costs by: eliminating paper invoices, eliminating hard-copy check payments, auditing each invoice to reduce payment errors, avoiding late fees and balance due invoices, and improving security to eradicate fraud opportunities.



**WEB-SDR** (Web Supply Discrepancy Reporting System): a web-based access-controlled SDR System that allows users to input shipping or packaging SDRs online by using an internet-based PC. This allows the SDR system to pre-fill data on the SDR. Help is available online where Program Management and SDR system experts work with customers to ensure their requirements are satisfied. WEB-SDR features include:

- Submit new SDRs online
- Submit follow-up, cancellation, correction, and reconsideration SDRs
- Submit ad hoc queries for data
- Upload/download attachments/documents
- Online detailed training slides
- Auto-fill feature uses DAAS requisition history to populate SDRs
- DoD Component processing systems will interface with WEB-SDR
- Allows for near real time SDR reporting and reduces response delays
- Web-based input of SDR resolution responses

**WEB VLIPS** (WEB Visual Logistics Information Processing System): a web-based, access-controlled query system that is useable from any internet attached PC. It accesses the Logistics On-line Tracking System (LOTS), a DAASC relational database system, which portrays the lifecycle of a logistics action. The WEBVLIPS customers can track requisitions from their release into the DoD pipeline, until the materiel is posted to the accountable records at the destination activity. WEBVLIPS also has the capability to track reports of excess, and the movement of those excesses to the destination depot or disposal site. WEBVLIPS integrates information on DoDAAD, MILRI, Source of Supply, DoD Project Code, Port Code, Transaction Status Code, Unit of Issue Code, Signal Code, Hold Code, Advice Code, Condition Code, and Mode Code to assist the user in tracking a requisition or excess through its lifecycle. Help is available to assist in understanding MILS data. Program management and subject matter expert's work with customers to ensure their requirements are satisfied.

**WRS** (Marine Corps War Reserve System): a Class 1, mainframe-based application that integrates capabilities for requirements determination, registration of requirements, sourcing requirements, TPFDD development plan, withdrawal execution, and supports Supply Classes I, II, III, IV, VII and IX.