



**DEPARTMENT OF THE NAVY**  
HEADQUARTERS UNITED STATES MARINE CORPS  
3000 MARINE CORPS PENTAGON  
WASHINGTON DC 20350-3000

MCO 5585.5A  
PS  
24 FEB 2020

MARINE CORPS ORDER 5585.5A

From: Commandant of the Marine Corps  
To: Distribution List

Subj: MARINE CORPS MILITARY WORKING DOG (MWD) MANUAL

Ref: See Enclosure (1)

Encl: (1) References  
(2) Military Working Dog Manual Procedural Guidance

1. Situation. This Order is an updated Marine Corps Order that includes the Military Working Dog (MWD) Manual and should be reviewed in its entirety. This Order provides policy that Commanders, Provost Marshals, Chiefs of Police, and MWD section personnel require; and establishes guidelines and procedures for MWD teams, both military and civilian, in the performance of their duties per references (a) through (ar).

2. Cancellation. MCO 5585.5.

3. Mission. To provide policy and procedures, documented in enclosure (2), required to operate an MWD section and to integrate MWD teams into operational and non-operational assignments.

4. Execution

a. Commander's Intent and Concept of Operations

(1) Commander's Intent

(a) This Order establishes policies, procedures, and qualification standards associated with the formation and utilization of Marine Corps MWD teams required for the support of installation, operating forces, and other government agencies.

DISTRIBUTION STATEMENT A: Approved for public release;  
distribution is unlimited.

24 FEB 2020

(b) Establish guidelines and procedures related to the organization and administration of MWD sections aboard Marine Corps installations and field operations.

(2) Concept of Operations

(a) All Marine Corps installations and organizations shall be in compliance with this Order.

(b) Local standard operating procedures (SOP) may be developed to augment enclosure (2) which also addresses specific SOP and preparation guidance.

b. Subordinate Element Missions. Commanders will implement this Order and augment the guidance provided with local directives, as required.

5. Administration and Logistics

a. Recommendations concerning this Order are invited and will be submitted to the Commandant of the Marine Corps Physical Security Division (PS) via the appropriate chain-of-command.

b. Records Management. Records created as a result of this Order shall be managed according to National Archives and Records Administration (NARA) approved dispositions per references (a) and (aq) to ensure proper maintenance, use, accessibility, and preservation, regardless of format or medium. Refer to reference (ar) for Marine Corps records management policy and procedures.

c. Privacy Act. Any misuse or unauthorized disclosure of Personally Identifiable Information (PII) may result in both civil and criminal penalties. The Department of the Navy (DON) recognizes that the privacy of an individual is a personal and fundamental right that shall be respected and protected. The DON's need to collect, use, maintain, or disseminate PII about individuals for purposes of discharging its statutory responsibilities shall be balanced against the individuals' right to be protected against unwarranted invasion of privacy. All collection, use, maintenance, or dissemination of PII shall be in accordance with the Privacy Act of 1974, as amended (reference (b)) and implemented per reference (c).

d. All forms referenced in this Manual are listed in Appendix E, Table E-1, along with sourcing information and applicable instructions for completion.

6. Command and Signal

a. Command. This Order is applicable to the Marine Corps Total Force.

b. Signal. This Order is effective the date signed.

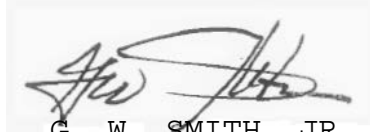
A handwritten signature in black ink, appearing to read "G. W. Smith, Jr.", is centered on a light gray rectangular background.

G. W. SMITH, JR.  
Deputy Commandant for  
Plans, Policies and Operations

Distribution: PCN 10208621100

References

- (a) SECNAV M-5210.1 W/CH 1
- (b) 5 U.S.C. 552a
- (c) SECNAVINST 5211.5E
- (d) MCO 5215.1K
- (e) DoD Directive 5200.31E, "DoD Military Working Dog (MWD) Program," August 10, 2011
- (f) MCO 5400.54
- (g) DC PP&O (POC) Msg 181152Z Jul 12 MWD Reporting and Tasking Requirements within the Marine Corps
- (h) MCO 5585.6
- (i) NAVMC 1200.1C
- (j) MARADMIN 607/11
- (k) MARADMIN 216/13
- (l) MARADMIN 365/12
- (m) MCO 4400.201 Volume 13
- (n) MCO 5580.2B W/CH 2
- (o) NAVMC 3500.10C
- (p) MCWP 3-34.1
- (q) 18 USC § 1385
- (r) MCO 5500.6H W/CH 1
- (s) SECNAVINST 5820.7C
- (t) CMC Msg 162041Z Aug 10, Use of MWD in Support of Civil Authorities
- (u) Department of Air Force and AF Security Forces Center Publication, "HQ AFSFC MWD DTS Guide," Version 7.0, January 1, 2013
- (v) MCO 5311.1E
- (w) MCO 4400.150
- (x) AR40-905/SECNAVINST 6401.1B/AFI 48-131
- (y) Director, DoD Military Working Dog Veterinary Service Publication, "Medical Care of Military Working Dogs by Handlers," June 1, 2014
- (z) NAVMC DIR 5040.6H
- (aa) MWD Narcotic Training Aid Program Division of Forensic Toxicology Office of the Armed Forces Medical Examiner Publication, "Drug Training Aid Accountability Guide," July 1, 2016
- (ab) DoD Directive 6400.04E W/CH 2, "DoD Veterinary Public and Animal Health Services," August 29, 2017
- (ac) Title 21 CFR
- (ad) MCO 8011.5A
- (ae) MCO 8020.10
- (af) NAVSEA OP 5 Volume 1
- (ag) MCO 5530.14A
- (ah) MCO 8023.3B

- (ai) NAVSUP P801/TW024-AA-ORD-010
- (aj) NAVSEA SW020-AC-SAF-010
- (ak) NAVSEA SW020-AF-HBK-010
- (al) NAVSEA SW023-AG-WHM-010
- (am) Title 49 CFR
- (an) MCO 8020.14
- (ao) US Air Force 341 TRS, "Qualified MWD Field Transition and Evaluation Guideline," December 2017
- (ap) Public Law 94-524, "Presidential Protection Assistance Act of 1976," October 17, 1976
- (aq) SECNAV Notice 5210
- (ar) MCO 5210.11F

**TABLE OF CONTENTS**

<u>IDENTIFICATION</u>	<u>TITLE</u>	<u>PAGE</u>
<b>Chapter 1</b>	<b>WRITTEN POLICY DIRECTIVES.....</b>	<b>1-1</b>
1000	Written Policy Directive System.....	1-1
1001	Purpose.....	1-1
1002	Policy.....	1-1
1003	Definitions.....	1-1
1004	Procedures.....	1-6
<b>Chapter 2</b>	<b>THE MWD PROGRAM.....</b>	<b>2-1</b>
2000	Background.....	2-1
2001	Purpose.....	2-1
2002	History.....	2-1
2100	Program Organization.....	2-3
2101	Purpose.....	2-3
2102	Structure.....	2-3
2103	Chain-of-Command.....	2-3
2200	Duties and Responsibilities.....	2-5
2201	Purpose.....	2-5
2202	Introduction.....	2-5
2203	Duties and Responsibilities.....	2-5
Figures		
2-1	USMC Program Staff.....	2-3
2-2	USMC MWD Chain-of-Command Communication.....	2-4
<b>Chapter 3</b>	<b>MWD SECTION PERSONNEL.....</b>	<b>3-1</b>
3000	Employment Categories.....	3-1
3001	Purpose.....	3-1
3002	Definitions.....	3-1
3003	Assignments.....	3-1
3100	Training.....	3-2
3101	Purpose.....	3-2
3102	Concept.....	3-2
3103	DoD MWD Personnel Courses.....	3-2
3104	Pre-Deployment Training.....	3-3
3105	Other Handler Instruction.....	3-4
3106	On-The-Job Training (OJT).....	3-5
3200	Special Requirements.....	3-7
3201	Purpose.....	3-7
3202	Requirements.....	3-7
3300	Qualifications.....	3-8
3301	Purpose.....	3-8
3302	Billets.....	3-8

**TABLE OF CONTENTS**

<u>IDENTIFICATION</u>	<u>TITLE</u>	<u>PAGE</u>
	3303 Prerequisites.....	3-8
	3304 Billet Descriptions.....	3-9
3400	Duties and Responsibilities.....	3-12
	3401 Purpose.....	3-12
	3402 Introduction.....	3-12
	3403 Billets.....	3-12
Tables		
	3-1 Contractor Support to MWD Operations.....	3-1
	3-2 USMC Authorized MWD Personnel Courses.....	3-2
	3-3 Special MWD Personnel Requirements..	3-7
	3-4 MWD Section Billet Prerequisites....	3-8
<b>Chapter 4</b>	<b>THE MILITARY WORKING DOG (MWD).....</b>	<b>4-1</b>
4000	Performance.....	4-1
	4001 Purpose.....	4-1
	4002 Introduction.....	4-1
	4003 Limiting Factors.....	4-1
	4004 Detection, Scouting, Tracking.....	4-5
4100	MWD Types.....	4-6
	4101 Purpose.....	4-6
	4102 Identification.....	4-6
4200	MWD Team Capabilities.....	4-7
	4201 Purpose.....	4-7
	4202 Capabilities.....	4-7
Figures		
	4-1 Effect of Wind Velocity on Detection Scent Cone.....	4-3
Tables		
	4-1 MWD Identification.....	4-6
<b>Chapter 5</b>	<b>MWD TEAM READINESS.....</b>	<b>5-1</b>
5000	Introduction.....	5-1
	5001 Purpose.....	5-1
	5002 Readiness Methodology.....	5-1
	5003 Importance of Readiness.....	5-2
5100	Determining MWD Team Readiness.....	5-3
	5101 Purpose.....	5-3
	5102 Categories.....	5-3
	5103 Criteria.....	5-3

**TABLE OF CONTENTS**

<u>IDENTIFICATION</u>	<u>TITLE</u>	<u>PAGE</u>
5200	Qualification Process.....	5-5
5201	Purpose.....	5-5
5202	TVC Process.....	5-5
5203	Training.....	5-7
5204	Validation.....	5-12
5205	Certification.....	5-19
5300	Failure to Maintain Team Readiness..	5-23
5301	Purpose.....	5-23
5302	Corrective Action.....	5-23
Figures		
5-1	Readiness Factors.....	5-2
5-2	Team Qualification Timeline.....	5-6
5-3	New MWD Field Transition Timeline...	5-6
5-4	Example Team Validation Timeline....	5-13
5-5	Validation Completion Timeline.....	5-15
Tables		
5-1	MWD Team Readiness Definition.....	5-3
5-2	MWD Team Readiness Criteria.....	5-4
5-3	WDMS Training Evaluation.....	5-12
5-4	Approved Reasons for Limited Validation.....	5-14
5-5	Validation Event Limitation.....	5-15
5-6	Capability Validation Prerequisite Criteria.....	5-16
5-7	Criteria for Revoking Validation....	5-17
5-8	Criteria for Revoking Certification.	5-20
<b>Chapter 6</b>	<b>MWD TEAM EMPLOYMENT.....</b>	<b>6-1</b>
6000	Concept of Employment.....	6-1
6001	Purpose.....	6-1
6002	Introduction.....	6-1
6003	Standard Operating Procedures (SOP).	6-2
6004	MWD Team Activities.....	6-2
6005	Supported Tasks.....	6-4
6006	Definitions.....	6-6
6100	Legal Considerations.....	6-8
6101	Purpose.....	6-8
6102	Considerations.....	6-8
6103	Interrogation.....	6-8



**TABLE OF CONTENTS**

<u>IDENTIFICATION</u>	<u>TITLE</u>	<u>PAGE</u>
	6104 Posse Comitatus Act.....	6-8
	6105 MWD Team Qualification.....	6-8
	6106 Use of Force.....	6-8
	6107 Policy for MWD Release.....	6-9
	6108 Probable Cause Search.....	6-11
	6109 Incident Reporting.....	6-12
	6110 Legal Testimony.....	6-13
6200	Use of MWD Capability.....	6-14
	6201 Purpose.....	6-14
	6202 Common to All MWD Teams.....	6-14
	6203 Patrol.....	6-15
	6204 Drug/Explosive Detection.....	6-18
	6205 Tracking.....	6-25
6300	Non-Operational Support to Federal and Civilian Law Enforcement Agencies (LEA).....	6-26
	6301 Purpose.....	6-26
	6302 Policy.....	6-26
	6303 State and Local Support.....	6-27
	6304 Federal Support.....	6-29
Figures		
	6-1 USMC MWD Team Employment Scenarios..	6-2
	6-2 Force Continuum Model with MWD Application.....	6-9
Tables		
	6-1 MWD Team Operational Supported Tasks	6-4
	6-2 MWD Team Validation Required for Utilization Type.....	6-14
	6-3 Search Requests.....	6-19
	6-4 Process for Non-Operational Missions	6-29
	6-5 Non-Operational Mission Types/Funding.....	6-34
<b>Chapter 7</b>	<b>MWD TEAM DEVELOPMENT AND DISPOSITION</b>	<b>7-1</b>
7000	MWD Team Determination.....	7-1
	7001 Purpose.....	7-1
	7002 Initial Planning.....	7-1
	7003 Validation of Existing Authorization	7-3
7100	MWD Organization Adjustments.....	7-4
	7101 Purpose.....	7-4
	7102 Introduction.....	7-4

**TABLE OF CONTENTS**

<u>IDENTIFICATION</u>	<u>TITLE</u>	<u>PAGE</u>
	7103 Personnel Change.....	7-4
	7104 MWD Change.....	7-5
7200	MWD Acquisition.....	7-6
	7201 Purpose.....	7-6
	7202 Introduction.....	7-6
	7203 Sourcing.....	7-6
	7204 MWD Replacement.....	7-6
7300	MWD Disposition.....	7-7
	7301 Purpose.....	7-7
	7302 Introduction.....	7-7
	7303 Preparation.....	7-8
	7304 Disposition Request.....	7-8
	7305 Execution of DoD Decision.....	7-9
	7306 WDMS Entries.....	7-11
	7307 Training Requirements for MWDs in Disposition Process.....	7-11
7400	Changing MWD Capability.....	7-12
	7401 Purpose.....	7-12
	7402 Request Process.....	7-12
	7403 Changing DD 1834.....	7-12
Figures		
	7-1 Example MWD Capability Authorization Change Request.....	7-13
	7-2 Example MWD Disposition Request.....	7-14
	7-3 Example MWD Capability Add Request..	7-15
	7-4 Example MWD Capability Remove Request.....	7-16
	7-5 Deficiency Report.....	7-17
<b>Chapter 8</b>	<b>ADMINISTRATION.....</b>	<b>8-1</b>
8000	Working Dog Management System (WDMS)	8-1
	8001 Purpose.....	8-1
	8002 Introduction.....	8-1
	8003 WDMS Access.....	8-2
	8004 WDMS Help Ticket.....	8-6
	8005 Support Requirements.....	8-6
8100	MWD Section Procedures.....	8-7
	8101 Purpose.....	8-7
	8102 Section Operations Binder.....	8-7
	8103 MWD-Handler Teaming Assignments.....	8-7
	8104 Activity Recording & Reporting.....	8-8

**TABLE OF CONTENTS**

<u>IDENTIFICATION</u>	<u>TITLE</u>	<u>PAGE</u>
	8105 MWD Team Qualification Documentation	8-19
	8106 MWD Records.....	8-23
	8107 Inspections/Visits.....	8-29
8200	MWD Processing.....	8-32
	8201 Purpose.....	8-32
	8202 Receiving.....	8-32
	8203 Shipping.....	8-34
	8204 Disposition.....	8-39
8300	MWD Section Operating Status.....	8-41
	8301 Purpose.....	8-41
	8302 Introduction.....	8-41
	8303 Operating Status Criteria.....	8-41
	8304 Operating Status Examples.....	8-45
	8305 Limitations.....	8-48
	8306 Acceptable Section Operating Status.	8-49
	8307 Corrective Action.....	8-50
Figures		
	8-1 Example Certification of Acclimation/Fitness for Travel Memorandum for the Record (MFR).....	8-52
	8-2 Examples of Activity Reporting.....	8-53
	8-3 Example Team Validation Revoke Annotation.....	8-21
	8-4 Example Team Certification Revoke Letter.....	8-57
	8-5 Example Training Aid Non-Availability Letter.....	8-58
	8-6 Example Team Validation Grace Period Memorandum for the Record (MFR).....	8-59
	8-7 Example Team Certification Grace Period Letter.....	8-60
	8-8 MWD Service Record Concept.....	8-24
	8-9 MWD Service Record - Active Folder..	8-26
	8-10 MWD Service Record - Archive Folder.	8-28
	8-11 Example of SE Section Operating Status - Scenario 1 [Operational]...	8-45
	8-12 Example of Supporting Establishment (SE) Section Operating Status - Scenario 2 [Limited].....	8-46

**TABLE OF CONTENTS**

<u>IDENTIFICATION</u>	<u>TITLE</u>	<u>PAGE</u>
8-13	Example of Supporting Establishment (SE) Section Operating Status - Scenario 3 [Marginal].....	8-47
8-14	Examples of MEF Section Operating Status.....	8-48
8-15	Example of Section Operating Status Trend Report.....	8-49
 Tables		
8-1	WDMS User Rights.....	8-5
8-2	MWD Untrained / Unutilized Reasons..	8-9
8-3	MWD Activity Recording Guide.....	8-11
8-4	Person Status.....	8-17
8-5	LAFB Form 375 Configurations.....	8-27
8-6	Team Validation Report Configurations.....	8-27
8-7	MWD Service Record Retention Guide..	8-29
8-8	MWD Section Inspection / Visit Guide	8-30
8-9	Final Documentation of MWD Disposition.....	8-40
8-10A	USMC MWD Section Operating Status Criteria-Supporting Establishment...	8-43
8-10B	USMC MWD Section Operating Status Criteria-LE Bn, MEF.....	8-44
<b>Chapter 9</b>	<b>MWD KENNELING AND SUPPORT EQUIPMENT.</b>	<b>9-1</b>
9000	Kenneling Requirements.....	9-1
9001	Purpose.....	9-1
9002	Introduction.....	9-1
9003	Permanent Kennel.....	9-1
9004	Temporary Kennel.....	9-2
9005	Transport Kennel.....	9-3
9006	Expedient Kennel.....	9-5
9100	Kennel Procedures.....	9-7
9101	Purpose.....	9-7
9102	Kennel Facilities.....	9-7
9103	Authorized Use.....	9-7
9104	MWD Emergency Evacuation Plan.....	9-7
9105	Summer/Winter Training Schedule.....	9-7
9106	Quarantine Area.....	9-7

**TABLE OF CONTENTS**

<u>IDENTIFICATION</u>	<u>TITLE</u>	<u>PAGE</u>
	9107 Security.....	9-9
	9108 Facility Warning Signs.....	9-9
	9109 Sanitation.....	9-10
	9110 Food Storage.....	9-11
	9111 Maintenance.....	9-11
9200	Support Equipment.....	9-13
	9201 Purpose.....	9-13
	9202 Definition.....	9-13
	9203 Objectives.....	9-13
	9204 Table of Equipment (T/E).....	9-13
	9205 Funding.....	9-14
	9206 Handler Weapon.....	9-14
	9207 Equipment Categories.....	9-14
	9208 Maintenance.....	9-23
	9209 Deployment Planning.....	9-23
Figures		
	9-1 Example Temporary Kennels.....	9-3
	9-2 Example Kennel Markings for Live Animal and This Way Up.....	9-4
	9-3 Example Field Expedient Shelters....	9-6
	9-4 Construction Guide for Elevated Field Expedient Shelter.....	9-6
	9-5 Example Foot Basin for Quarantine Area.....	9-8
	9-6 Kennel Facility Sign.....	9-10
	9-7 Example MWD Vehicle Markings.....	9-18
	9-8 Example Gunfire Training Kit.....	9-21
	9-9 Example MWD Radio Harness.....	9-23
	9-10 Example MWD Deployment Site Layout..	9-25
Tables		
	9-1 MWD Transport Kennel Measurement Formula.....	9-5
	9-2 MWD Equipment Categories.....	9-15
	9-3 Garrison Facility Equipment.....	9-16
	9-4 Garrison Vehicles.....	9-18
	9-5 Training Equipment.....	9-20

**TABLE OF CONTENTS**

<u>IDENTIFICATION</u>	<u>TITLE</u>	<u>PAGE</u>
9-6	9mm Blank Accessories for USMC Weapons.....	9-21
<b>Chapter 10</b>	<b>MWD CARE.....</b>	<b>10-1</b>
10000	Basic Care Activities.....	10-1
10001	Purpose.....	10-1
10002	Responsibilities.....	10-1
10003	Daily Routine and Record Keeping....	10-1
10004	Feeding.....	10-1
10005	Weight Control.....	10-2
10006	Physical Conditioning.....	10-3
10007	Grooming and Inspection.....	10-3
10008	MWD Fights and Bites.....	10-5
10009	MWD in Handler Living Quarters.....	10-6
10100	Safety.....	10-8
10101	Purpose.....	10-8
10102	Introduction.....	10-8
10103	General.....	10-8
10104	Muzzle Use.....	10-9
10105	Kennel Compound.....	10-10
10106	MWD in a Vehicle.....	10-11
10107	Operational Safety.....	10-12
10108	Emergency Handler Plan.....	10-13
10200	Medical.....	10-14
10201	Purpose.....	10-14
10202	US Army Veterinary Support.....	10-14
10203	Emergency MWD Care.....	10-16
10204	Parasite Control.....	10-16
10205	Medication.....	10-16
10206	First Aid.....	10-17
10207	Acclimation.....	10-18
10208	MWD Medical Deployment Categories (Med Cat).....	10-19
Figures		
10-1	Example Leash Muzzle.....	10-10
Tables		
10-1	MWD Health Point Check.....	10-4
10-2	Key MWD Health Record Documents.....	10-15
10-3	WDMS Recording Guide for MWD Medical Deployment Categories (Med Cat).....	10-20

**TABLE OF CONTENTS**

<u>IDENTIFICATION</u>	<u>TITLE</u>	<u>PAGE</u>
<b>Chapter 11</b>	<b>DRUG TRAINING AIDS.....</b>	<b>11-1</b>
11000	Policy.....	11-1
11001	Purpose.....	11-1
11002	Requirement.....	11-1
11003	Involved Government Agencies.....	11-1
11004	Operating Procedures.....	11-1
11005	Communications to the MWD Program Manager.....	11-2
11006	Registration.....	11-2
11007	Drug Training Aid Sourcing.....	11-2
11008	Substance Control.....	11-2
11009	MWD Team Drug Qualification.....	11-2
11010	MWD Imprinting on New Drug Odors....	11-2
11011	Pseudo-Drug Training Aids.....	11-3
11012	DEA Site Inspection.....	11-3
11100	Canine Drug Scent Kit (CDSK).....	11-4
11101	Purpose.....	11-4
11102	Configuration.....	11-4
11103	Allowance.....	11-4
11200	Personnel.....	11-5
11201	Purpose.....	11-5
11202	Custodians.....	11-5
11203	Authorized Training Aid Users.....	11-9
11300	New MWD Section Account.....	11-10
11301	Purpose.....	11-10
11302	Startup Process.....	11-10
11303	Initial CDSK Issue.....	11-10
11400	On-Going Activities.....	11-11
11401	Purpose.....	11-11
11402	Receiving.....	11-11
11403	Storage.....	11-12
11404	Weighing Aids.....	11-13
11405	Recall.....	11-14
11406	Shipping.....	11-14
11407	Annual DEA Registration (CONUS)....	11-15
11408	Reporting.....	11-15
11409	Training/Drop Aid Use.....	11-17
11410	Record Keeping.....	11-18
11500	Relocation of Aids for Temporary Assigned Duty (TAD)/Deployment.....	11-22
11501	Purpose.....	11-22
11502	Assignment of Remote Site Custodian.	11-22

**TABLE OF CONTENTS**

<u>IDENTIFICATION</u>	<u>TITLE</u>	<u>PAGE</u>
11503	AFMES Notification.....	11-22
11504	Security.....	11-22
11505	Record Keeping.....	11-23
Figures		
11-1	Example Custodian & User Appointment Letter.....	11-24
11-2	Example Power of Attorney for DEA Order Forms.....	11-25
11-3	Example Change of Primary Custodian Letter.....	11-26
11-4	Example DEA / AFMES Initial Registration Letter.....	11-27
11-5	Example Request for Return of Unserviceable Aid.....	11-29
11-6	DEA Form 222 Log w/Example Entries..	11-30
11-7	Drug Training Aid Accountability Folder Configuration.....	11-20
11-8	Daily Issue/Return Log w/Example Entries.....	11-31
11-9	Example Disinterested Party Appointment Letter.....	11-33
11-10	Example Drug Training Aid/DEA 222 Inventory Report.....	11-34
11-11	Example of Notification of Temporary Relocation of Drug Training Aids....	11-36
Tables		
11-1	Drug Safe Configuration.....	11-13
<b>Chapter 12</b>	<b>EXPLOSIVE TRAINING AIDS.....</b>	<b>12-1</b>
12000	Policy.....	12-1
12001	Purpose.....	12-1
12002	Requirement.....	12-1
12003	Determining Threat.....	12-1
12004	Involved Government Agencies.....	12-1
12005	Operating Procedures.....	12-2
12006	Communications to the MWD Program Manager.....	12-2
12007	Explosive Training Aid Sourcing.....	12-2
12008	Specialized Explosive Training.....	12-3
12009	Substance Control.....	12-3
12010	MWD Team Explosive Qualification....	12-3
12011	MWD Imprinting on Explosive Odors...	12-3



**TABLE OF CONTENTS**

<u>IDENTIFICATION</u>	<u>TITLE</u>	<u>PAGE</u>
	12012 Mixing Versus Blending Explosive Training Aids.....	12-3
	12013 Pseudo-Explosive Training Aids.....	12-4
12100	Explosive Odor Training Aids.....	12-5
	12101 Purpose.....	12-5
	12102 Explosive Training Aids.....	12-5
	12103 Non-Explosive Training Aids.....	12-10
12200	Personnel.....	12-12
	12201 Purpose.....	12-12
	12202 Roles and Responsibilities.....	12-12
	12203 Duties.....	12-13
	12204 Qualification and Certification.....	12-14
	12205 Training and Qualification.....	12-14
12300	On-Going Activities.....	12-16
	12301 Purpose.....	12-16
	12302 Cross Contamination.....	12-16
	12303 Explosive Detection Training Event Planning.....	12-16
	12304 CEAP Safety.....	12-18
	12305 Non-Explosive Training Aid Safety...	12-22
	12306 Transportation.....	12-22
	12307 Reporting.....	12-24
	12308 Physical Inventory.....	12-24
	12309 Record Keeping.....	12-25
12400	Training Aids for Deployment.....	12-29
	12401 Purpose.....	12-29
	12402 Explosive Training Aids.....	12-29
	12403 Non-Explosive Training Aids.....	12-29
	12404 Expeditionary Explosive Training Aid Storage.....	12-29
Figures		
	12-1 Canine Explosive Authorization Package (CEAP) and Associated Containers - PMO Example.....	12-5
	12-2 Example Delegation of Authority [NAVMC 11797].....	12-31
	12-3 Placard, Explosive.....	12-23
	12-4 Example Explosive/Non-Explosive Training Aid Physical Inventory Report.....	12-32
	12-5 Example Explosive Training Check Sheet.....	12-35

**TABLE OF CONTENTS**

<u>IDENTIFICATION</u>	<u>TITLE</u>	<u>PAGE</u>
12-6	Explosive Training Aid Accountability Folder Configuration.	12-28
12-7	Daily Issue/Return Log w/Example Entries - Explosive Aids.....	12-36
12-8	Daily Issue/Return Log w/Example Entries - Non-Explosive Aids.....	12-38
Tables		
12-1	Personnel Duties and Qualification..	12-15
12-2	Explosive Detection Training Event Planning.....	12-17
12-3	Explosive Detection Training Area Signs.....	12-20
12-4	Expeditionary Storage Containers....	12-30
APPENDIX A	ABBREVIATIONS.....	A-1
APPENDIX B	MWD TEAM PERFORMANCE.....	B-1
APPENDIX C	GUIDE TO COMMUNICATIONS WITH MWD PM.	C-1
APPENDIX D	MWD TEAM QUALIFICATION STANDARDS AND GUIDELINES.....	D-1
APPENDIX E	FORMS AND REPORTS.....	E-1
APPENDIX F	MWD SECTION OPERATIONS BINDERS.....	F-1
APPENDIX G	MWD TEAM TRAINING AND TROUBLESHOOTING TECHNIQUES.....	G-1
APPENDIX H	MWD STATUS REPORTING GUIDE.....	H-1
APPENDIX I	MWD TEAM EQUIPMENT GUIDE.....	I-1
APPENDIX J	MWD DEMONSTRATION GUIDE.....	J-1
APPENDIX K	KENNEL FACILITY DESIGN GUIDE.....	K-1
APPENDIX L	CANINE DRUG SCENT KIT (CDSK).....	L-1
APPENDIX M	CANINE EXPLOSIVE AUTHORIZATION PACKAGE (CEAP).....	M-1
APPENDIX N	CANINE NON-EXPLOSIVE TRAINING AIDS..	N-1
APPENDIX O	ON-THE-JOB TRAINING GUIDE.....	O-1
APPENDIX P	MWD TRAILER MAINTENANCE GUIDE.....	P-1
APPENDIX Q	CLOTHING GUIDE FOR NON-OPERATIONAL MISSIONS.....	Q-1

## Chapter 1

### Written Policy Directives

#### Section 1000 - Written Policy Directive System

1001. Purpose. This section defines the structure and application of the United States Marine Corps Military Working Dog (MWD) Manual written policy directive system (WPDS) and provides Law Enforcement Executives, the MWD section, and other personnel with a better understanding of its importance, use, and applicability.

1002. Policy. A WPDS has been established per reference (d) to inform military police staff and the MWD section of expectations and guidance in the performance of their duties, to establish the basis for accountability and the means to fairly evaluate MWD section performance. This section formally documents the structure and component parts of the written directive system in a manner that will increase its utility and application and provide for continuity in its development.

#### 1003. Definitions

1. Military Working Dog Program Manager (MWD PM). The MWD PM conducts strategic planning for future MWD capabilities and operations, provides fiscal and administrative management, supplies technical assistance, develops, implements, and reviews procedures and policies for the Marine Corps MWD Program.

2. Deputy Military Working Dog Program Manager (Dep. MWD PM). The Dep. MWD PM assists the MWD PM in the management of the Marine Corps MWD Program by establishing and reviewing MWD policies and procedures for utilization and standardized training and employment of MWD teams. The Dep. MWD PM plans, programs, and monitors MWD Training Courses provided by the Department of Defense (DoD) MWD Executive Agent, ensuring courses of study are meeting the needs and requirements of the Marine Corps. When requested, the Dep. MWD PM performs duties as an evaluator for the Inspector General of the Marine Corps' (IGMC) Command Inspection Program (CIP) or for a major subordinate commander's (MSC) Commanding General's Inspection Program (CGIP), providing subject matter expert (SME) guidance and input to field units concerning MWD standards. The Dep. MWD PM oversees management of Explosive/Drug Training Aids for the MWD Program and provides recommendations for changes to MWD training scent kits. The Dep. MWD PM is the program lead for

the Working Dog Management System (WDMS) and provides help desk support to field units for WDMS issues.

3. MWD Program Operations Manager (Ops Mgr). The Ops Mgr assists the MWD PM in conducting research for the development of new or the enhancement of existing MWD capabilities for future operational use and conducts oversight of on-going special projects to ensure the needs and requirements of the Marine Corps MWD Program are met. The Ops Mgr also coordinates non-operational MWD team support for United States Secret Service (USSS), Department of State (DoS), and other external agencies with established notification procedures; processes MWDs for disposition from the Marine Corps MWD Program; conducts MWD section assist visits to ensure the MWD section is in compliance of rules and regulations and MWD teams are capable for operational use by conducting validations; and conducts Handler and/or MWD problem solving training. The Ops Mgr also performs duties as an evaluator for the IGMC's CIP and MSC's CGIP, providing SME guidance and input to field units concerning MWD standards.

4. MWD Program Chief. The MWD Program Chief assists the MWD Program staff in the management of the Marine Corps MWD Program. The MWD Program Chief manages MWD School seat assignments; conducts MWD section assist visits to ensure the MWD section is in compliance of rules and regulations and MWD teams are capable for operational use by conducting validations; and conducts Handler and/or MWD problem solving training. The MWD Program Chief also performs duties as an evaluator for the IGMC's CIP and MSC's CGIP, providing SME guidance and input to field units concerning MWD standards.

5. Provost Marshal (PM)

a. Installation. The Provost Marshal serves as the installation commander's senior law enforcement representative and as a special staff officer responsible for the daily operations and functional management of the installation Provost Marshal Office (PMO).

b. Marine Expeditionary Force (MEF). The Provost Marshal serves as the commander's senior law enforcement representative but as a special staff officer without operational responsibilities.

c. Law Enforcement (LE) Battalion (Bn). There is no PM at the battalion level but the battalion commander is responsible

24 FEB 2020

for all administrative and operational matters for MWDs assigned to the MEF.

6. Police Chief (PC). On installations with a Marine Corps Police Department (MCPD), the PC serves as the installation commander's senior law enforcement representative and as a special staff officer responsible for the daily operations and functional management of the MCPD.

7. Commanding Officer (CO). Refers to the responsible officer over the MWD Section as specified below for each location:

a. Installation. The PM/PC.

b. LE BN. The Bn commander.

8. Law Enforcement (LE) Executives. LE Executives includes PM, military police commissioned officers, military police senior staff noncommissioned officers (E8-E9), PCs, Deputy Chiefs of Police and supervisory police officers (GS 11-14).

9. Military Working Dog (MWD) Section. Unless specifically stated to the contrary, the term "MWD section" includes both military and civilian (government service) MWD personnel operating in either installation support or LE Bn commands. Exceptions for LE Bn sections will be identified as "LE Bn". Depending on the size of the section, personnel assigned to the MWD section may consist of the kennel master, trainer, and handler.

10. Military/Civilian Personnel. There is no distinction between military personnel of the United States Marine Corps and federally employed civilians performing the same function unless otherwise signified by the addition of the word "Military" or "Civilian".

11. Kennel Master (KM). The KM supervises the MWD section for either the installation or the LE Bn. The KM is responsible for the overall management of the MWD section operations and ensures MWD teams are trained, validated, operationally ready and properly equipped to provide an anti-terrorism/force protection (AT/FP) measure for the installation and/or world-wide deployment in support of the Marine Air-Ground Task Force (MAGTF).

12. Trainer. The trainer conducts MWD training for MWD teams. For the installation, the trainer must ensure MWD teams are

trained, validated and operationally ready to provide an AT/FP measure for the installation. For the LE Bn, the trainer must ensure MWD teams are trained for world-wide deployment in support of the MAGTF.

13. Handler. The MWD handler provides daily care and grooming for their assigned MWD. The MWD handler ensures sustainment skills are maintained in their assigned MWD for either providing AT/FP measure for the installation or for world-wide deployment in support of the MAGTF.

14. Military Working Dog (MWD). An MWD is a Government-owned dog procured, acquired or bred, and trained to meet MWD requirements of the military departments and DoD agencies.

15. Military Working Dog (MWD) Team. An MWD team is a validated operational element consisting of a school trained handler and a trained MWD.

16. Policies. Policies provide overarching guidance regarding the general goals and procedures on specific matters. Policies are concise position statements based on underlying organizational principles, goals, values, and operational philosophies. They are designed for broad general direction and guidance primarily designed for use by all members of the MWD community, PMO or MCPD.

17. Procedures. Procedures build on the foundation of policy statements to provide specific guidance on required, desired, or preferred methods of operations or conduct. Procedures are detailed instructions on the means and methods for carrying out the policy directive and generally draw the boundaries of permissible discretion in performing specific tasks or duties. Procedures may be included within individual chapters or appendixes.

18. Rules. As opposed to procedure statements that often provide flexibility and discretion, rules are characterized by their inflexibility. Rules define situations where typically no deviation or exceptions to agency-authorized actions are permitted. Rules are, by definition, restrictive, and as such, are avoided within the WPDS unless specifically required by federal law or military department policy. Rules, in daily operations, are normally issued by the cognizant commander, or as directed by the local PM/PC.

24 FEB 2020

19. Terms Limiting MWD Section Discretion. There are three categories of terms used in MWD Manual WPDS. Personnel responsible for the development of such directives and the MWD section that carries them out shall be aware of the limitations on discretion that these terms convey. These terms are classified as judgmental, directive, and restrictive or prohibitive in nature.

a. Judgmental. The word "may" is used to convey the utmost discretion to the MWD section. "May" indicates the MWD section should employ their best judgment in addressing a situation by relying on experience, training, the stated mission and values of the Marine Corps, and the general guidance provided in this Manual.

b. Directive. The word "should" or "should not" is used to convey the appropriate MWD section actions in given circumstances. Directives should be followed whenever reasonably possible. However, it is recognized that exceptions to desired actions can be anticipated in these circumstances that could require alternative action. The MWD section is therefore authorized whenever reasonable to use limited discretion to deal effectively with the situation or problem.

c. Restrictive or Prohibitive. The terms "shall" or "shall not" or "will" or "will not" impose absolute requirements or prohibitions on MWD section actions. Considering the full set of circumstances surrounding many situations confronted by the MWD section cannot be fully predicted, such terms must be used with care and with the understanding that failure to abide by such restrictions may result in disciplinary action. Where deemed appropriate, however, these terms may appear in policies, procedures, and rules.

20. United States Marine Corps Military Working Dog Manual. The MWD Manual is a position statement by or authorized through the Deputy Commandant for Plans, Policies and Operations (DC, PP&O) via Assistant Deputy Commandant for Plans, Policies and Operations (Security) (ADC, PP&O Security) or also titled as the Director Security Division [**henceforth referred to in this Manual as "PS Div"**] which guide or direct the actions and activities of the MWD section in the performance of their duties at all Marine Corps activities and installations. Directives encompass all means by which PS Div communicates instructions, orders and duty requirements to MWD sections, to include policies within this Order, procedures, rules, regulations,

Marine Administrative (MARADMIN) messages, memoranda, and instructional materials.

1004. Procedures

1. Directive Development and Approval

a. The PS Div retains authority for approval of all policy within this Order.

b. Maintenance of the written directive system is assigned to PS Div. In coordination with LE executives, PS Div shall be responsible for organization, review, revision, update, and purging of this Order on a continuous basis.

c. The installation/LE Bn commander retains the authority to issue directives through memoranda or special orders that have bearing only on the specific functions or operations of their MWD section. Such directives shall be consistent with this Order.

d. It is the concurrent responsibility of LE executives to ensure policies, procedures and other directives affecting their MWD section reflect the best practices for accomplishment of organizational activities, duties and responsibilities. To this end, LE executives are responsible for ensuring:

(1) Required development, updates, and refinements of all PS Div policies and procedures affecting their MWD section are identified and that these requirements are forwarded in a timely manner via their respective chain-of-command.

(2) Written explanation and justification of proposed changes to currently active directives is prepared and kept current. This justification/discussion may include, but is not limited to, the legal basis and requirements for the policy change; reference to and adherence to professional standards or practices, compliance with military department philosophies, directives, standards, and protocols; and related information that supports, explains, and substantiates the recommended change.

e. Signed approved copies of this Order, either in hardcopy or digital format, will be distributed per established Marine Corps procedures defined in reference (d).



f. The MWD section will maintain a hardcopy of this Order in an organized, complete, and current manner.

2. Military Working Dog (MWD) Manual Components. The MWD Manual is made up of chapters and sections, and contains the components referenced below:

a. Record of Change. A formatted listing of all revisions posted to this Manual since its issuance.

b. Table of Contents. Sequential listing of topics covered in the MWD Manual and their location in the document.

c. Chapters. The MWD Manual is composed of a series of chapters, containing one or more sections, whose subject matter is interrelated. It is indexed using the system below.

d. Sections. Sections are identified with a four or five digit number, depending on whether a chapter has one or two digits, and end in "000". The first section would be "1000".

e. Paragraphs. Major paragraphs are identified by either a four or five digit number, depending on whether the chapter has one or two digits. The first major paragraph of the first section in the first chapter begins with the four-digit number "1001".

f. For proper format, see the following diagram:

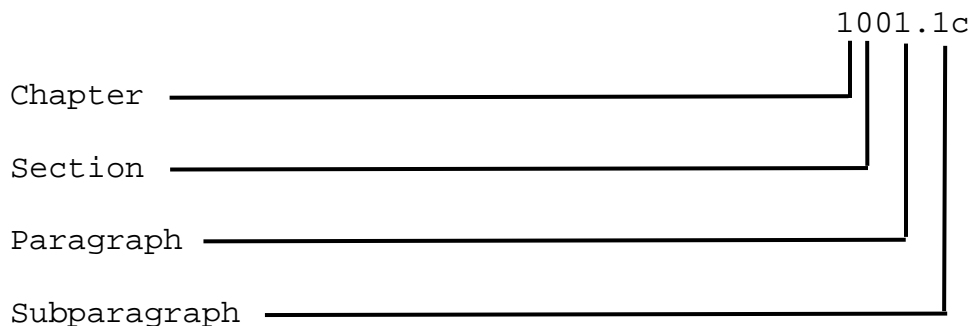

**NOTE**

Each policy section, though inter-related within a chapter, is designed as a "stand alone" directive document. The first digit identifies the chapter number, the second digit the section number, and the third and fourth digits the paragraph number. The numbers following the decimal identify the subparagraph number. This allows for ready cataloguing, referencing, and indexing of individual policy directives, and aids in updating of material.

24 FEB 2020

3. Authorized Forms. See Appendix E for current forms authorized to be used by the MWD section.

4. Pagination. Pages are numbered sequentially throughout each chapter. Page numbers are centered and shall be preceded by notation which identifies the chapter. Example: 1 - 10.

a. "1" denotes the chapter in which the policy appears.

b. "10" denotes the page number.

5. Applicability. Unless otherwise stated, all provisions of this Order pertain to service members and civilian employees of the United States Marine Corps and are applicable to the Total Force.

## Chapter 2

### The Military Working Dog (MWD) Program

#### Section 2000 - Background

2001. Purpose. This section provides background information about the evolution of the MWD Program.

#### 2002. History

1. Early Dog Applications. Since ancient times, dogs have been used for the protection of life and property. From these early stages, dog training and employment has been continuously refined to produce a highly sophisticated and versatile extension of the warrior's own senses. Even the most complex machines remain unable to duplicate the operational effectiveness of a properly trained MWD team. These dogs have been heroes, showing bravery under fire, saving lives (often losing their own), and bringing comfort to the injured and infirmed.

2. 1940s. The Marine Corps' war dog training program was initiated in 1942. The War Dog Program Activation Order stated: "The dog trainer and handler must be a good combat Marine, capable of scouting and patrolling on his own, the dog being merely the means of increasing his radius of perception." The dogs used in this program could outclass a man in alertness, lack of sleep, and in general condition; but in actually learning his lessons, dog trainers found it necessary to give the dogs frequent breaks and not spend too many hours a day on the lessons. Marine Raiders were enthusiastic over the performance of the war dogs in the Bougainville operation (Nov-Dec 1943).

3. 1950s. MWDs were trained at Fort Carson, Colorado, organized into scout dog platoons, and used in the Korean conflict for sentry duty and support of combat patrols. In 1957, MWD training moved to the current school location at the Joint Base San Antonio-Lackland, Texas (JBSA-Lackland), with the U.S. Air Force (USAF) serving as the DoD MWD Executive Agent (MWDEA) for the DoD MWD Program per reference (e).

4. 1960 - 80s. Throughout the Vietnam Conflict, the Marine Corps used dogs with considerable success. Most of these were sentry dogs used to safeguard critical installations such as ports and airfields. A new dimension in canine utilization was

24 FEB 2020

realized when marijuana detector dog teams were trained and deployed to assist military police in suppressing illicit drug trafficking. Sentry and marijuana detector dog teams were then deployed worldwide in support of Military Police. An important outgrowth of the conflict was the development of canine research and development (R&D) efforts. These ongoing efforts were able to initiate the first steps toward developing a more intelligent and stronger military working dog, training dogs to detect specific drugs and explosives, developing multiple-purpose dogs, and employing tactical dogs by electronic remote control.

5. 1990 - early 2000s. MWDs were deployed around the globe in military operations such as Just Cause, Desert Shield and Desert Storm, Uphold Democracy, Enduring Freedom and Iraqi Freedom. MWD teams are effectively utilized to enhance the security of critical facilities and areas, bolster AT/FP missions, and assist in the detection of explosive devices and weapons caches providing the commanders with a wide range and flexible asset. MWD teams have become a highly deployable capability that is employed in dynamic ways never before imagined. These specialized teams aid commanders in stability and support operations as well as in war fighting. Being modular and mobile makes these teams very agile. As situations dictate, MWD teams are quick to arrive and able to conduct various operations. Their versatility allows for effective transformation at all echelons among readiness for deployment and operations on the ground, through redeployment and back to readiness.

6. Current Situation. The highly aggressive dog tactics of the 1960s and 1970s are long gone. Today's MWD Program effectively employs expertly trained and motivated handlers coupled with highly intelligent breeds of dogs. These teams are continuously rotating between their assigned duties and deployments worldwide to perform joint operations, multi-echelon tasks, and interagency missions. This Order provides the current capabilities of the Military Police MWD Program. As technology and world situations change, the MWD team will continue the transformation process and give commanders the full-spectrum capabilities needed to be combat multipliers on the battlefield as well as a persuasive AT/FP asset.

Section 2100 - Program Organization

2101. Purpose. This section describes the organizational structure and command relationships for those individuals who provide the direction, management and control of the Marine Corps MWD Program.

2102. Structure. This program extends from staff members located at Headquarters Marine Corps (HQMC) through the major Marine Corps commands to the owning commands with MWD capabilities. The USMC MWD Program is a program of record that has organizational structure and responsibilities that reach from the DoD level down to the individual handler. Figure 2-1 illustrates the MWD Program staff structure and location. The related organizational information of the MWD section is provided in Chapter 3.

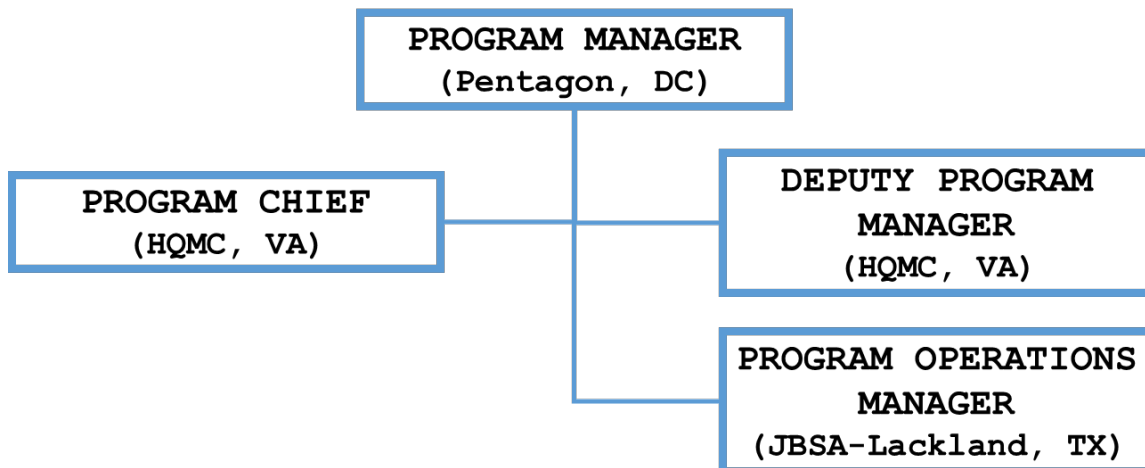
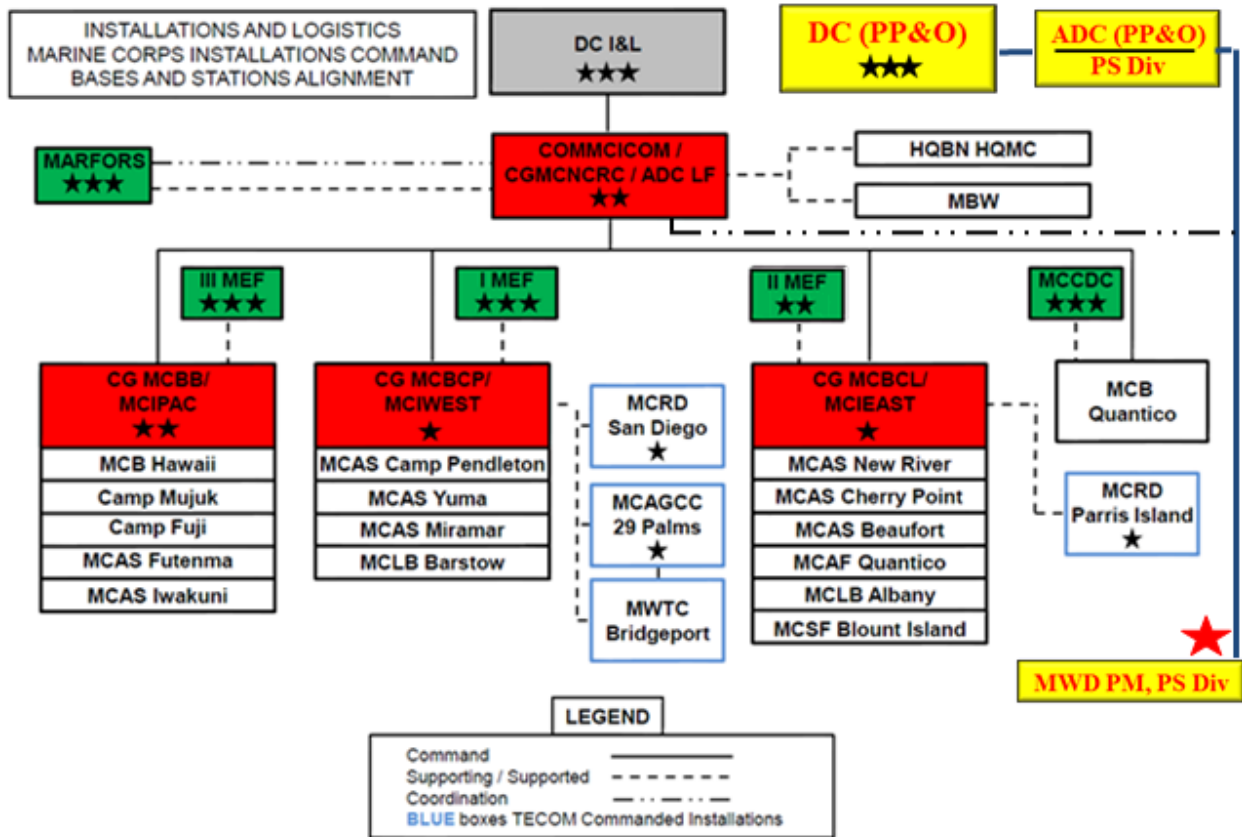

Figure 2-1.--USMC Program Staff

2103. Chain-of-Command. The MWD PM and his staff are responsible to the DC PP&O via the PS Div. The MWD Program staff interfaces with the MWDEA, and those Marine Corps major commands that have resident MWD capabilities through the chain-of-command communication as illustrated in figure 2-2. Appendix C provides a guide on communicating with the MWD PM.



- NOTES**
1. Above chain-of-command per reference (f).
  - ★ 2. For purposes sourcing Marine Corps support to non-operational missions [see section 6300], MWD PM coordinates all requirements through Marine Corps Installation Command (MCICOM) per reference (g).
  3. For purposes of submitting formal command request letters [see type "A" media in Appendix C], routing will be through the chain-of-command through MCICOM.
  4. All other types of communication media between the MWD section and MWD PM can be routed direct [see Appendix C] with copy to the next level of command.

Figure 2-2.--USMC MWD Chain-of-Command Communication

Section 2200 - Duties and Responsibilities

2201. Purpose. This section describes the duties and responsibilities for those individuals who provide the direction, management and control of the Marine Corps MWD Program.

2202. Introduction. Each individual within the program chain-of-command bears a shared responsibility to expeditiously respond to inquiries and tasks to ensure the MWD team is provided with the right equipment, training, and information to meet both operational and non-operational commitments.

2203. Duties and Responsibilities. The following are the duties and responsibilities of those Marine Corps staff and line personnel that have direct impact on the operations of the MWD section.

1. Military Working Dog (MWD) Program Staff

a. Military Working Dog Program Manager (MWD PM)

(1) Responsible for the management of the Marine Corps MWD Program for supporting Military Police operations.

(2) Provides administrative management; technical assistance; develops, implements and reviews procedures and policies for the Marine Corps MWD Program.

(3) Technical authority for the development, supervision, and evaluation of the Marine Corps MWD Program worldwide.

(4) Conducts strategic planning for future capabilities and operations for the MWD Program.

(5) Plans and distributes assignments for MWDs and provides support guidance to the 58XX Military Occupation Specialty (MOS) monitor on recommended movements and assignments of personnel to meet both normal and exceptional workload requirements.

(6) Performs studies, analysis, and other emergent tasks to meet DoD and Marine Corps objectives.

(7) Represents the Marine Corps during semi-annual Joint Service MWD Committee (JSMWDC) meetings per reference (e).

24 FEB 2020

(8) Maintains contact with DoD personnel, federal, state and local law enforcement agencies (LEA) connected with the MWD Program.

(9) Assists in the coordination of operational and non-operational MWD team support when requested.

(10) Manages MWD Program fiscal requirements to include funding submissions for non-TECOM related training courses and assists with maintaining MWD kennel facilities.

(11) Primarily responsible for staff training, security, facility management and the development of programs pertaining to MWD; use of community resources; and staff professionalism.

b. Deputy MWD Program Manager (Dep. MWD PM)

(1) Assists the MWD PM in the management of the Marine Corps MWD Program.

(2) Assumes the duties and responsibilities of the MWD PM in his absence.

(3) Manages the USMC WDMS module, oversees upgrades to the system, and provides help desk support to field units.

(4) Prepares reports, briefs, etc.

(5) Coordinates with other Government agencies for the distribution of MWD drug/explosive training aids to user commands.

(6) Informs the Functional Area Sponsor (HQMC PSL) on the management of the MWD Functional Area Checklist questions and conducts inspections for the IGMC or MSC and Staff Assistance Visits when requested.

c. Operations Manager (Ops Mgr)

(1) Conducts research and development of new MWD capabilities for future operational use.

(2) Monitors existing MWD capabilities to ensure the needs and requirements of the MWD Program are currently being met for operational use.



(3) Conducts oversight of on-going special projects to ensure the needs and requirements of the Marine Corps MWD Program are met.

(4) Provides administrative management of MWD Program personnel and MWDs by utilizing the WDMS.

(5) Coordinates non-operational MWD team support for USSS, DoS, and other agencies as requested by the Air Force Law and Order Division MWD Scheduling Cell [**Hereafter in this Order referred to as the "MWD Scheduling Cell".**]

(6) Manages the planning, distribution, and disposition of MWDs to Marine Corps user commands.

(7) As the on-site liaison at the 341 Training Squadron (341 TRS), JBASA-Lackland; coordinates command inquiries on matters impacting the Marine Corps MWD Program.

(8) Provide SME support on staff assistance visits to Marine Corps MWD sections for compliance of rules and regulations.

d. Military Working Dog (MWD) Program Chief

(1) As the SME on Marine Corps MWD qualification and employment, provides guidance in response to inquiries from other staff members at HQMC.

(2) Assists in the management of the Marine Corps MWD Program.

(3) Manages MWD school seat assignments.

(4) Conducts handler and/or MWD problem solving training when requested.

(5) Provides SME support to units on MWD rules and regulations and conducts inspections for the IGMC and Staff Assistance Visits when requested.

2. Marine Corps Installation (MCI) Commands. Each Marine Corps Installaion (MCI) command identified in figure 2-2 will have a designated MWD point of contact (POC) for MWD related inquiries. These individuals will be the primary contact for requesting MWD team support to missions outside the immediate installation area

of responsibility as shown in the table. The chain-of-command communication routing is defined in figure 2-2.

3. Installation

a. Commanding Officer (CO)

(1) Responsible for security operations of an installation.

(2) The Search Granting Authority for certifying MWD teams (see paragraph 5205). The Search Granting Authority may delegate (and usually does) this responsibility to the installation PM/PC.

b. Provost Marshal (PM)/Police Chief (PC)

(1) Establishes standard operating procedures (SOP) for the following:

(a) Utilization of MWD teams in military police law enforcement operations.

(b) Employment of MWD teams aboard the installation, based on threat condition and other factors.

(2) Ensures the installation MWD section is maintained and operating per this Order.

(3) Establishes budgetary planning and funding for the proper feeding, kenneling, training, and transportation of the MWD teams.

c. Operations Officer/Operations Chief. Responsible for the MWD section readiness.

4. Law Enforcement Battalion (LE Bn)

a. Commanding Officer. Provide MWD teams in support of the MAGTF.

b. Battalion (Bn) Staff

(1) Facilitate Bn training plan and coordinate authorizations (Marine specific).

24 FEB 2020

(2) Provide required material, supply and logistics for the MWD section.

(3) Responsible for the development and implementation of the Mission Essential Task List (METL).

c. Commanding Officer, H&S Co

(1) Ensures MWD teams are prepared for deployment in support of the Range of Military Operations (ROMO).

(2) Ensures the MWD section complies with all applicable orders and regulations.

(3) Provides training and operational support to the MWD section.

(4) Ensures that the MWD section is evaluated on Mission Essential Tasks (MET).

Chapter 3

Military Working Dog (MWD) Section Personnel

Section 3000 - Employment Categories

3001. Purpose. This section describes the different employment categories for personnel assigned to billets that comprise the Marine Corps MWD Program.

3002. Definitions. The Marine Corps employs the following categories of personnel which vary by the contractual arrangement that defines their salary, benefits, length of service and legal obligation:

1. Military. Personnel enlisted in the Marine Corps on active duty, assigned to perform duties in support of MWD sections.
2. Civilian. Personnel hired as a U.S. Government Service (GS) employee and assigned to perform duties in support of MWD section.
3. Contractor. Non-GS civilian personnel and/or teams hired to perform support services at any MWD section as identified in table 3-1.

<b>Table 3-1.--Contractor Support to MWD Operations</b>	
<b>Type Support</b>	<b>Comments</b>
<b>Handler</b>	Not authorized to team contractor w/MWD
<b>Contract Working Dog (CWD) Team</b>	<ul style="list-style-type: none"><li>• Not authorized without prior approval from MWD PM (see Appendix C)</li><li>• See reference (h)</li></ul>
<b>Other:</b> <ul style="list-style-type: none"><li>• <b>Dog Care</b></li><li>• <b>Grooming</b></li><li>• <b>Training</b></li><li>• <b>Kennel Cleaning</b></li></ul>	<ul style="list-style-type: none"><li>• Command funded</li><li>• Local SOP required for related issues to include, but not limited to, kennel access, duties, and safety.</li></ul>

3003. Assignments. Military MWD personnel are assigned to both the installation security commands and the LE Bns. Those installation MWD sections within the Continental United States (CONUS) have an organizational structure comprised of military and civilian police MWD personnel. At the two logistics bases, the MWD section consists entirely of civilian police.

Section 3100 - Training

3101. Purpose. This section describes the MWD specific training associated with the military and civilian billets in the Marine Corps MWD Program.

3102. Concept. Training is required to ensure MWD teams remain proficient. Training should be realistic, challenging, scenario driven and relate to all of the possible operations in which MWD teams will operate according to the unit's mission. Properly trained MWD teams are better prepared to accomplish all facets of MWD missions. Personnel assigned to MWD section duties are qualified through a process of formal initial training schools, supervisor schools, specialized training, ongoing qualification training, or possibly from MWD on-the-job training (OJT). The level of completion of these training activities will meet prerequisite requirements for selection to key MWD section/MWD section billets of handler, trainer, or KM as discussed in detail in this Chapter. It is the responsibility of the gaining unit to provide advanced training to a new handler or MWD for development as an MWD team. Qualification training is continuously required to ensure that MWD teams are reliable for use in patrol, tracking, drug detection, and explosive detection both on and off-leash.

3103. Department of Defense Military Working Dog (DoD MWD) Personnel Courses. Participation in formal MWD related training sessions must be approved in advance by the MWD PM [see Appendix C]. The current formal MWD courses are provided for Marine Corps personnel at the specified locations and described in table 3-2:

<b>Table 3-2.--USMC Authorized MWD Personnel Courses</b>			
<b>Course Identification / Location</b>	<b>Duration (Days)</b>	<b>Attendee (1)</b>	<b>Purpose (2)(3)(5)</b>
<b>MWD Basic Handler Course CID F06MTM1 JBSA-Lackland, TX</b>	79	Military Civilian	To train and qualify personnel in the handling of MWDs for patrol and detection of drug and explosives. Provides training in the knowledge and skills needed to perform duties as military/civilian MWD handler. (4)

24 FEB 2020

<b>Table 3-2.--USMC Authorized MWD Personnel Courses</b>			
<b>Course Identification / Location</b>	<b>Duration (Days)</b>	<b>Attendee (1)</b>	<b>Purpose (2)(3)(5)</b>
<b>Specialized Search Dog (SSD) Course CID F06MN31 JBSA-Lackland, TX</b>	130	Military	This course trains selected personnel in the skills and knowledge necessary to perform duties as a SPECIALIZED SEARCH DOG HANDLER. Focus is on off-leash explosive detection. (4)
<b>Combat Tracker Dog Course (CTD) CID F06MN80 JBSA-Lackland, TX</b>	35	Military Civilian	This course trains selected personnel in the skills and knowledge necessary to perform duties as a COMBAT TRACKER DOG HANDLER. Focus is on tracking techniques in urban and rural environments. (4)
<b>MWD Trainer/Kennel Master Course CID F0681J1 Distance Learning</b>	N/A	Military Civilian	Computer-based training provides basic administrative instruction on the MWD section at a unit level, preparing students for exercises in the MWD Trainer/Kennel Master Course at JBSA-Lackland.
<b>MWD Trainer/Kennel Master Course CID F0681J1 JBSA-Lackland, TX</b>	15	Military Civilian	Provides instruction on the management and supervision of the MWD section at a unit level and basic entry level MWD training. (4)(5)
<b>MWD Team Deployment Training Course CID M14MTS2 YPG, Yuma, AZ</b>	20	Military	Provides instruction on combat environment MWD operations in preparation for deployment.
<b>NOTES:</b>			
(1) Prerequisites are defined in the Marine Corps Training Information and Management System (MCTIMS) per reference (i).			
(2) Students reporting to the 341 TRS for school courses must have their annual training completed prior to arrival.			
(3) All students must bring a copy of their DoD cyber awareness training certificate to have access to government computers during the course.			
(4) Within <u>60 days</u> of assignment, the KM must, and the trainer should, be scheduled to attend the MWD KM Course unless the individual has previously completed the same CID numbered course.			
(5) Course completion should be recorded in WDMS [KM/Personnel Mgmt tab] and the official military personnel file (OMPF) [or GS equivalent].			

#### 3104. Pre-Deployment Training

1. Schedule. Due to the scheduling complexities involved in a deployment, it may be necessary for MWD teams to attend a

training session and return to the home base kennel while awaiting transport to the embark location.

2. Locations. The following locations have established facilities for MWD pre-deployment training:

- MAGTFTC, 29 Palms, CA - Enhanced Mojave Viper
- Yuma Proving Ground, Yuma, AZ
  - MWD Team Deployment Training Course [see table 3-2]
  - Specialized unit training as coordinated with course staff
  - CTD Training

3105. Other Handler Instruction

1. Electronic Collar (E-collar)

a. The E-collar user must be documented to have successfully completed an MWD PM-approved course that addresses obedience, aggression, and directional training using E-collar.

b. Currently, the only formal E-collar training provided by the 341 TRS is at the SSD course [see table 3-2]. SSD course graduates since 2013 are considered qualified only to utilize E-collar in SSD applications.

c. MWD PM will schedule courses conducted by civilian instructors at central locations. The class schedule will be announced in advance along with instructions on submitting candidates and funding. Graduates will be awarded a certificate which will qualify them as an E-collar user only. Course completion should be recorded in WDMS [KM/Personnel Mgmt tab] and the OMPF [or GS equivalent].

d. KMs should notify the MWD PM [see Appendix C] when they foresee a training issue resulting from not having sufficient qualified personnel in the use of the E-collar.

2. Commercial. Commands are authorized to send MWD handlers to commercially sponsored courses at the command's expense. Although a handler may be trained in special handling/training technique, he/she is not authorized to apply non-standard techniques [from those described in Appendix G] unless specifically approved by MWD PM [see Appendix C].

3. Train-the-Trainer. Funded by HQMC when available. Provides hands-on experience to military or civilian personnel using additional MWD team training techniques and troubleshooting.

3106. On-the-Job Training (OJT)

1. Introduction. OJT is sponsored by the command to identify and mentor potential candidates from the resident military/civilian police force who want to:

- Attend the MWD Basic Handler course and receive a secondary MOS of 5812 [military handler] or 0083 [civilian handler]
- or
- Attend an MWD specialty handler course (i.e., SSD, CTD) to receive formal training which authorizes teaming with the MWD capability [candidate will already have attended the MWD Basic Handlers Course].

2. Procedures. Local SOPs will be developed to define procedures necessary to implement the OJT program described in Appendix O. See paragraph 3103 to schedule a seat in the formal school. Prior to attending the school, the OJT candidate should perform limited kennel duties and/or MWD capability introduction with focus on completing the program training objectives. Upon successful completion of the 341 TRS course, the graduate will return to the command as a qualified Basic MWD Handler.

**NOTE**

Some MOS 5812 candidates may be identified while attending the 5811 basic military police training. These Marines are assigned to a command prior to attending the MWD Basic Handler's Course. During this period, the KM should enter the candidate into OJT to determine if the individual meets all prerequisites and is suited to work closely with MWDs.

3. Prerequisites. Only personnel meeting the MOS requirements in reference (i) may be considered for OJT.

4. Work Restrictions

a. OJT personnel may handle all MWDs within a training environment, but will never be utilized operationally until all formal handler training is completed.



24 FEB 2020

b. WDMS Activity Recording. See paragraph 8003.2 for instructions on gaining access to WDMS for the purpose of recording MWD activity when OJT personnel are assigned as a caretaker.

c. OJT Duration. When operational commitments permit, OJT personnel should complete 30 calendar days in the MWD section prior to attending the MWD Basic Handler's course.

Section 3200 - Special Requirements

3201. Purpose. This section describes requirements which are placed on MWD personnel to ensure they are fully capable to support both operational and non-operational MWD unique missions.

3202. Requirements. Table 3-3 specifies the requirements unique to the MWD Program.

Table 3-3.--Special MWD Personnel Requirements								
Item	MWD Section Billet (1)						Requirement (2)	Ref
	Base			LE Bn				
	KM	T	H	KM	T	H		
<b>Spleen</b>	X	X	X	X	X	X	Must have spleen that is fully functional while assigned to MWD section.	(i)
<b>Shots</b>				X	X	X	Current Rabies shot <u>required</u> for deployed MWD personnel.	(j)
<b>Credit Card</b>	X	X	X				Issued Government Travel Credit Card (GTCC).	(k)
<b>Passport</b>			(3)			(3)*	Obtain <b>OFFICIAL-NO FEE</b> passport	(l)
<b>Clothing Allowance</b>			(4)				See Appendix Q for clothing requirements and examples.	(m)
<b>NOTES:</b>								
(1) Requirement applies to following military and civilian billets unless otherwise noted: (KM)-Kennel Master (T)-Trainer (H)-Handler [all unless otherwise noted]								
(2) Billet holders should have required item within 60 days of assignment unless otherwise noted.								
(3) Military and civilian handlers for EDD/PEDD <u>only at base support sections</u> . The KM shall apply for the OFFICIAL-NO FEE passport to a military or civilian handler after being teamed with an EDD/PEDD and achieving a team readiness status within WDMS of READY, R1, R2 or R3. * <u>LE Bn</u> MWD sections will maintain "Official Passports" on any inbound personnel who were previously issued a passport but not request initial issue for any assigned personnel.								
(4) Military handlers for EDD/PEDD only. Civilian handlers are not eligible for the allowance. The KM shall apply for the <u>Long Term TAD</u> civilian clothing allowance to a military handler after being teamed with an EDD/PEDD and achieving a team readiness status within WDMS of READY, R1, R2 or R3. The reference policy defines the waiting period required for a supplemental clothing allowance.								

Section 3300 - Qualifications

3301. Purpose. This section describes the qualifications for those billets within the MWD section.

3302. Billets. The MWD section Table of Organization (T/O) identifies the number of individuals assigned to an MWD section for the following billets:

- Handler
- Trainer
- Kennel Master

3303. Prerequisites. Table 3-4 provides an overview of the education and experience prerequisites that should be followed for MWD section personnel.

<b>Table 3-4.--MWD Section Billet Prerequisites</b>							
<b>Billet</b>	<b>MWD Training Courses</b>					<b>Experience Years (Min)</b>	
	<b>Handler</b>			<b>KM (1)</b>	<b>YPG (6)</b>	<b>Handler</b>	<b>Trainer</b>
	<b>Basic</b>	<b>CTD</b>	<b>SSD</b>				
<b>Handler (5):</b>							
<b>PDDD</b>	X						
<b>PEDD</b>	X						
<b>CTD (3)</b>	X	X					
<b>SSD (3)</b>	X		X				
<b>Trainer (5)</b>	X			X		1.5	
<b>Kennel Master (5)</b>	X			X		2	1
<b>MWD Trainer</b> [JBSA-Lackland, TX]	X					2	
<b>MWD Instructor</b> [JBSA-Lackland, TX]	X					2	
<b>SSD Instructor/Trainer</b> [JBSA-Lackland, TX]	X		X			2	1
<b>CTD Instructor/Trainer</b> [JBSA-Lackland, TX]	X	X				2	1
<b>Instructor</b> [Deploy Sch., YPG, AZ]	X	(2)	(2)	X	X	3	1
<b>Lead Instructor</b> [Deploy Sch., YPG, AZ]	X			X	X	3	3
<b>R&amp;D Analyst</b> [JBSA-Lackland, TX]	X			X		3	5
<b>Chief, MWD, HQMC (4)</b>	X			X		4	6

24 FEB 2020

Table 3-4.--MWD Section Billet Prerequisites							
Billet	MWD Training Courses				Experience Years (Min)		
	Handler			KM	YPG	Handler	Trainer
	Basic	CTD	SSD	(1)	(6)		
<b>NOTES:</b>							
(1) KM/trainer should attend KM course within one year of being assigned duties.							
(2) Instructor will have CTD and/or SSD formal training.							
(3) The Basic Handler's Course is a prerequisite for assignment to a specialty course (i.e., CTD, SSD).							
(4) MWD Chief should have been assigned to both Supporting Establishment and Operational Forces billets as a KM and as an instructor at a formal MWD course.							
(5) All civilian personnel shall meet the same criteria as military personnel in equivalent billets.							
(6) Has completed the MWD Team Pre-Deployment Course (YPG, Yuma, AZ) as an MWD handler.							

3304. Billet Descriptions1. Handler**NOTE**

Civilian police handlers are only assigned to the base/installation MWD section.

a. MWD handlers are assigned to an MWD to establish the MWD team that is the basic structure element within the MWD section. The MWD team performs operations according to the MWD capability.

b. The 5812 [MWD Handler] is a Necessary MOS (NMOS) requiring the individual to first possess the 5811 primary MOS (PMOS). Upon completion of the MWD Basic Handler's Course, the 5812 MOS will become an Additional MOS (AMOS) in the Marine's Service Information. Civilian police are all government service designator 0083 (Civilian Police Officer) without a secondary designator for being an MWD handler.

c. In all situations, personnel assigned to train and/or perform the duties as an MWD handler will be a volunteer.

d. Meet schooling and prerequisite requirements per tables 3-2 and 3-4 prior to operational employment.

24 FEB 2020

e. Reference (i) defines the current requirements for achieving the MOS 5812. Reference (n) defines the criteria for revoking this MOS.

f. Reference (n) and local position descriptions define the qualification requirements for a civilian police handler.

g. An important consideration for selection of a civilian handler is the individual's ability to meet established standards for transport of explosive materials related to the performance of their duties to include: passing an explosive material physical, completion of annual explosive/hazardous material training and, if applicable, obtain/maintain an appropriate commercial hazard license (see table 12-1).

h. Requirements for any other specialized handler application will be published by separate correspondence.

## 2. Trainer

a. Trainers are experienced and competent MWD handlers who exhibit the knowledge and leadership ability to identify and correct MWD team deficiencies. The trainer is selected for his/her ability and overall knowledge of training, mentoring, and employing MWD assets.

b. The trainer is a full time position and is not usually assigned an MWD.

c. Meet schooling and prerequisite requirements per tables 3-2 and 3-4.

## 3. Kennel Master

a. Proven record of maturity and aptitude to be responsible for the overall management of the magnitude of operations associated with the MWD section which he/she is to be assigned.

b. An NCO (or civilian equivalent).

c. Meet schooling and prerequisite requirements per tables 3-2 and 3-4.

d. The KM duties alone are a significant responsibility and should not include handling an MWD.

24 FEB 2020

e. If there is no 5812 meeting the requirement for KM, the senior MWD handler will be designated as the KM.

f. If the command assigns an individual who does not meet the above requirements for a military KM, the title held is "Kennel Supervisor". This role should be for the purposes of providing administration support on a temporary basis until a qualified replacement is available (see Appendix C).

Section 3400 - Duties and Responsibilities

3401. Purpose. This section describes those duties and responsibilities (in addition to those required for directly supporting command operations, battle skills training, and the MOS proficiency training) associated with the military and civilian MWD section billets.

3402. Introduction. Regardless of whether the function is held by a military or civilian police officer, the billet terminology, qualification requirement, and responsibilities are the same as related to MWD activities.

3403. Billets. The following billet information applies to all MWD sections unless LE Bn specific is noted:

1. Handler

a. Provide the daily care and grooming for assigned MWD per the guidance provided in Chapter 10.

b. Conduct MWD training per the Optimum Training Plan (OTP) and the published training schedule (see Chapter 5).

c. Enter MWD team qualification and utilization records daily in WDMS (see Chapter 8).

d. Maintain MWD kennels daily.

e. Perform additional kennel duties, when assigned.

f. Maintain all issued equipment and inspect for service ability prior to and immediately following use.

g. Report any unsafe condition involving equipment or facilities to the next higher level in the chain-of-command.

h. Submit travel claims in the Defense Travel System (DTS).

i. LE Bn Specific Duties:

(1) While deployed, maintain the MWD team activity records in either handwritten or digital form for later recording per requirements of Chapter 8.

(2) When deployed alone, advise the supporting unit commander on the proper employment of their MWD.

## 2. Trainer

a. Unless circumstances dictate otherwise (such as small MWD Table of Equipment (T/E) or operational requirements), the trainer is not assigned to an MWD as a team.

b. Evaluate each MWD team and develop an OTP [see Chapter 5] to ensure each MWD team achieves and maintains readiness status.

c. Develop the MWD section training schedule to meet the MWD team OTP and coordinate with other command training requirements and operational activity.

d. Develop detection events within WDMS and assign MWD teams.

e. Supervise training as required to maintain the MWD team qualification standards of Appendix D.

f. Coordinate the administration and security requirements to obtain and utilize drug and explosive training aids.

g. Evaluate validation/certification events in a consistent manner per Appendix D.

h. In the case of an extended regular handler absence, ensure training is sufficient to maintain the MWD qualification until return of the handler or reassignment to another handler.

i. As directed by the KM, perform other duties in support of kennel operations.

j. Ensure all monthly records are reviewed, corrected, signed and provided to next reviewer by the **5<sup>th</sup> of every month.**

k. Report any unsafe condition involving equipment or facilities to the next higher level in the chain-of-command.

l. In the absence of a qualified trainer, the KM will assign a best individual to assume these duties.

## 3. Kennel Master

a. Unless circumstances dictate otherwise (such as small MWD T/E or operational requirements), the KM is not assigned to an MWD as a team.



- b. Supervise the MWD section personnel.
- c. Responsible for the overall management of MWD section operations.
- d. Ensure the section maintains MWD team readiness per Chapter 5 and an acceptable operating status per Chapter 8.
- e. Act as the SME on the proper utilization and employment of MWD teams. Within this role, the KM can provide the commander with the following program trifold forms as quick references to the topics noted:
  - Form MC MWD-6, Commander's Guide to MWD Capabilities
  - Form MC MWD-8A, Commander's Guide to MWD Team Qualification and Readiness: Support Establishment
  - Form MC MWD-8B, Commander's Guide to MWD Team Qualification and Readiness: Law Enforcement Battalion
- f. Ensure training and procedures are established to meet the command requirements for MWD team integration into installation and MAGTF operations.
- g. Ensure the section training is conducted per this Manual, local SOPs and the Commander's intent.
- h. Maintain sufficient resources to conduct training and operations to include the following:
  - (1) Kenneling and life support
  - (2) Transportation assets
  - (3) Explosive and drug training aids
  - (4) MWD Specific equipment
  - (5) Computer assets
  - (6) Climate control measures, if necessary
- i. Ensure that WDMS section status information is maintained on a timely basis per reporting requirements in Chapter 8.

24 FEB 2020

j. Sign all validate/certification reports for MWD teams assigned or attached to the section.

k. Coordinate the MWD team certification with the search granting authority or designee.

l. Maintain kennel and training facilities, ensuring all MWDs are properly cared for and handlers are knowledgeable of responsibilities.

m. While TAD, on leave, or away from the office for any reason, ensure second-in-charge appointee is aware of duties and responsibilities to maintain section operations.

n. Coordinate MWD support for protective service detail (PSD) missions and other federal, state, local LEAs when tasked.

o. Ensure the MWD section operation binders are complete and current per Appendix F.

p. Coordinate with the local U.S. Army Veterinary Corps Officer (VCO) to establish and report the MWD medical Category Codes (Refer to Chapter 10).

Chapter 4

The Military Working Dog (MWD)

Section 4000 - Performance

4001. Purpose. This section provides an overview and articulation of the MWD performance and those factors that impact the ability to complete a task.

4002. Introduction. The MWD ability to detect an intruder will exceed the handler's detection capability and other physical, mechanical, or electrical intrusion detection systems (IDS). Like other highly specialized equipment, MWDs complement and enhance the command capabilities and enable commanders to perform their mission more effectively with significant savings of manpower, time, and money. To obtain the maximum value from the MWD services, it is essential to have a sound understanding of the tactical situation and the conditions best suited to their employment. MWDs are subject to outside influences that have a direct bearing on their behavior. The performance of any MWD, no matter how highly trained, is not constant. The MWD cannot be expected to work efficiently under every type of condition. This is often not fully appreciated; instances have occurred where adverse criticism has been leveled against an MWD simply because the person/individual responsible for the MWD employment was unaware of the MWD limitations or did not accept the MWD handler's advice or recommendation. The MWD should be used only after an analysis of the tactical picture, climatic conditions, and terrain has determined to be reasonable for MWD application. The MWD can work seven days a week, providing that the MWD has adequate rest [this may vary depending on the dog].

4003. Limiting Factors. The actual continuous working time and the number of tasks that the MWD can be assigned will depend upon, but not limited to, the following factors:

**IMPORTANT**

Each handler must make a concerted effort to identify the strengths and limitations of their assigned MWD.

1. Military Working Dog (MWD) Ability and Character. The MWD sense of sight, smell and hearing provide significant detection capabilities and coupled with obedience/patrol training; the MWD provides a physical and psychological deterrent and significantly enhances the commander's ability to protect forces

24 FEB 2020

and assets. MWDs can detect and locate a person or targeted odor faster than a human, even when obstacles, distance or terrain might obscure the threat from human detection. Public knowledge of MWD team capabilities provides commanders with a formidable deterrent wherever the MWD team is employed.

2. Working Environment. All MWD types rely on their sensory characteristics to perform scouting, detection and tracking tasks. The following defines the different scents (odors) that comprise the scent picture of the working environment:

a. Target Odor. The explosive/narcotic or human scent that the MWD is trained to detect.

b. Accompanying Odor. Associated with some form of wrapper or containers used to transport or hide the explosive/narcotics. Also, includes ingredients used in the mixture of the explosive.

c. Residual Odor. Refers to the drug/explosive particles that remain on an item after it has made contact with the substance. Depending on a wide variety of factors, residual odor can remain in an area for extended periods. The MWD may respond to residual odor and be able to pick up trace amounts of odor from hands, clothing, seat covers, furniture, etc. The handler is trained to recognize the MWD change in behavior on targeted odors and will notify search team members when the MWD has showed this change.

d. Human Odor. Relates to scent that is projected from any component of the human body; e.g., pieces of skin, sweat, human urine and feces, blood.

e. Ecological Odor. Examples are crushed grass, disturbed earth, bacterial disturbance in the ground, etc.

f. Reinforcing Odor (Tracking Only). Examples are food residue, gasoline/diesel, i.e., any scent that is not produced from the body or nature, and adds to the specific nature of the person we are asking the dog to identify.

g. Airborne Odor. Refers to any and all scent that is above ground level and causes the MWD to maintain a nose upward position. If an MWD consistently follows aerial scent, it is referred to as "trailing" which is utilized by patrol MWDs during a scout event.

h. Ground Odor. Refers to any and all scent that remains at a ground surface level causing the MWD to maintain a nose down behavior.

3. Weather conditions. The weather has a significant impact on the MWD performance so the handler must be aware of the weather situation and take into consideration the factors described below:

**NOTE**

MWDs can work in non-acclimated environments but may be at reduced efficiency. Refer to Chapter 10 for discussion on the acclimation process for an MWD being introduced to a new environment.

a. Wind. As wind velocity increases, the scent cone narrows resulting in a smaller area in which the MWD can detect the target odor. During unfavorable wind conditions, the MWD can still detect by sound and sight. MWDs work best when placed to take advantage of odors carried on the wind. When there is little or no wind, the MWD can detect odor up to hundreds of meters away from any direction, see figure 4-1.

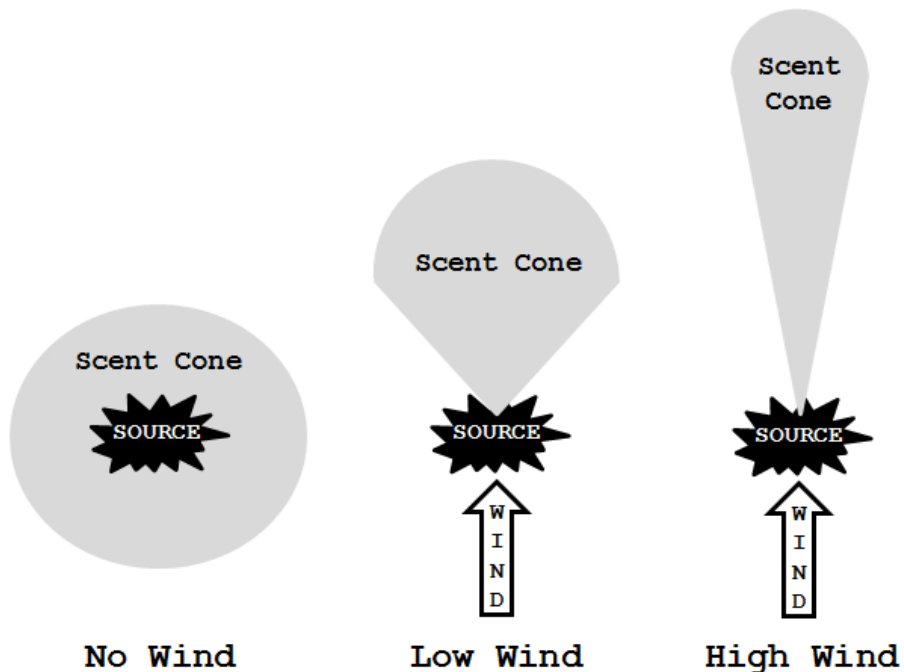

Figure 4-1.--Effect of Wind Velocity On Detection Scent Cone

24 FEB 2020

b. Visibility. Vision is reduced by movement, smoke and sandstorms, dense undergrowth, heavily wooded areas, and jungle growth.

c. Precipitation. Rain, can reduce the MWDs ability to use its senses. During inclement weather, the MWD ability to detect an intruder will exceed the detection ability of the handler and other physical, mechanical, or IDS.

d. Temperature and Humidity

(1) Since odor molecules are heavier than air, heat will cause odor to increase and expand over a larger area, while cold will minimize odor availability.

(2) Low humidity quickly disperses odor patterns.

(3) High temperatures and high humidity may cause fatigue in MWDs.

(4) Extreme temperature, both hot and cold, effect the MWD efficiency.

(5) Hot surfaces will also reduce the MWDs ability to use its senses. MWDs are sensitive to working on hot surfaces, but this can be mitigated by the use of dog booties during operations in these conditions.

(6) In hot, humid weather, the MWD may work at less than optimum. Depending on conditions, the MWD may require additional cool-down breaks.

4. Detection Factors. The following factors work together as important considerations when evaluating the potential effectiveness of any MWD detection situation:

a. Quantity. MWDs are trained to detect relatively small amounts of odor in CONUS; deployed MWDs should train and be exposed to the larger amounts they may encounter in operations. The larger the surfaces of a hide, the greater the circumference of the odor given off.

b. Type. Each hidden item will have its own field of odor, which can vary from very small to very large, according to its structure and composition.

c. Time

(1) The longer an item is left in a location, the longer the area of odor will remain.

(2) Generally, the air surrounding the item absorbs the odor, and the surface the item is sitting on picks up the odor.

d. Location. The place of concealment will affect how much odor is permitted to exude (e.g., underground, in a drawer, underwater, or in a plastic bag). MWD may respond in the area around the item due to residual odor left during the placement process.

e. Covering Odors/Masking Agent. Close proximity of other odors or agents can have negative impact on the MWD effectiveness to detect the target odor.

4004. Detection, Scouting and Tracking

**NOTE**

A "Quarry" is the object of a tracking pursuit; in a training event, this would be a person who maneuvers through an area to establish a scent trail. In operations, it might be an IED installer, lost person, or a suspect who has fled from a crime scene.

The explosive and drug detection MWDs are trained to primarily use the airborne odor as the primary source of scent. Patrol MWDs primarily use the airborne odor when conducting scouting events. The CTD trains to use ground odor as the primary source for scent picture throughout training and utilization. Tracking is unique in that the MWD is always tracking a form of residual odor until the location of the quarry. Tracking is trained to be scent specific and always track greatest concentration of odor of the quarry identified. For example, if the quarry walked through the area twice, three days apart and the dog tracked to older of the two lines that would actually be a training deficiency indicating the dog was not tracking the freshest concentration of scent.

Section 4100 - MWD Types

4101. Purpose. This section identifies the types of MWDs currently available to support Marine Corps operations.

4102. Identification

a. The Marine Corps military police utilize a combination of single purpose and dual purpose MWDs to achieve the most effective capability mix for anticipated operational requirements. Table 4-1 identifies the MWD types found within the inventory along with the assigned logistics identifications of Table of Authorized Material Control Number (TAMCN) and National Stock Number (NSN).

<b>Table 4-1.--MWD Identification</b>		
<b>TAMCN</b>	<b>MWD Type</b>	<b>NSN</b>
K00097B	PATROL/DRUG DETECTOR DOG (PDD)	8820002437542
K00117B	PATROL/EXPLOSIVE DETECTOR DOG (PEDD)	8820001883880
K00127B	EXPLOSIVE DETECTOR DOG (EDD)	8820000433526
K00137B	SPECIALIZED SEARCH DOG (SSD)	8820015264588
K00147B	COMBAT TRACKER DOG (CTD)	8820015364048
K00217B	DRUG DETECTOR DOG (DDD)	8820002388577

**NOTE:**

The scope of this manual does not include the following MWDs supporting the specified commands:

- IED Detection Dog (IDD)** - IDD Program, MCSC
- Multi-Purpose Canine (MPC)** - MARSOC

b. The single purpose DDD and EDD are not normally in the T/E, but can be at an installation for the following reasons:

(1) Command accepted replacement MWD with the intent that the base will conduct patrol training for future certification.

(2) MWD patrol certification removed due to physical issues.

(3) Command accepted MWD that could not be patrol trained, from a LE Bn MWD section or the 341 TRS.

(4) Command requested T/E change to a single purpose MWD for specific local commitment.



Section 4200 - MWD Team Capabilities

4201. Purpose. This section articulates the capabilities of each MWD type.

4202. Capabilities. The following provides the operational overview of each MWD team capability along with the associated MWD type designation:

**NOTE:**

Refer to -

- Table 6-1 for operational supported tasks by MWD type.
- Appendix B for the performance objectives for each MWD type.

1. Patrol Dog (PD). Patrol Dogs (PDs) can be utilized as a force multiplier and is especially valuable in area security, force protection, and antiterrorism operations thus allowing the commander to employ less Marines and apply his resources to other areas. The PDs in the Marine Corps are dual-certified as either an explosive detector dog (EDD) or drug detector dog (DDD). These types of MWDs are referred to as patrol/explosive detector dog (PEDD) and patrol/drug detector dog (PDDD). The PD's contribution is most effective when the MWD team is utilized as a walking patrol. As a walking patrol, the PD team can check or clear buildings, perimeters, and open areas thereby deterring trespassers, vandals, violent persons, infiltrators, and other would-be criminals. Mobility significantly increases the potential area of coverage. The PDs are trained to attack/apprehend suspects, stop those who may attempt to escape, and protect their handlers from harm. The PDs are capable of working in urban and rural environments, day or night. If a PD is required to work at night, a night vision device (NVD) should be provided to the handler, enabling him to see and read the dog's alert.

2. Drug Detector Dog (DDD). DDDs are single-purpose MWDs that search for and detect illicit drugs and drug-associated paraphernalia primarily on-leash. The DDDs are capable of searching vehicles, buildings, roadways, and open areas. The DDDs are capable of working in urban and rural environments, day or night. If a DDD is required to work at night, a NVD should be provided to the handler, enabling him to see and read the dog's alert. The DDDs are only employed to search people when there is a barrier provided between the MWD and the subject.

24 FEB 2020

3. Explosive Detector Dog (EDD). EDDs are single-purpose MWDs that search for and detect Improvised Explosive Devices (IEDs), explosive components, and weapon caches primarily on-leash. The EDDs are capable of searching vehicles, buildings, roadways, and open areas. The EDDs are capable of working in urban and rural environments, day or night. If an EDD is required to work at night, a NVD should be provided to the handler, enabling him to see and read the dog's alert. The EDDs are only employed to search people when there is a barrier provided between the MWD and the subject.

4. Specialized Search Dog (SSD). SSDs are single-purpose MWDs that search for and detect IEDs, explosive components, and weapon caches primarily off-leash, up to 100-plus meters from the MWD handler. The SSDs may be directed (i.e., controlled) through the search pattern by voice command, hand and arm signals, a combination of both, or voice command via radio. The SSDs are capable of searching vehicles, buildings, roadways, and open areas. The SSDs are capable of working in urban and rural environments, day or night. If a SSD is required to work at night, a NVD should be provided to the handler, enabling him to see and read the dog's alert. The SSDs are only employed to search people when there is a barrier provided between the MWD and the subject.

5. Combat Tracker Dog (CTD). CTDs are single-purpose MWDs that will track humans and may alert on a human presence (i.e., strongest scent and specific scent) primarily on-leash. The CTD can re-establish contact with enemy combatants (ECs), relocate friendly personnel, or conduct reconnaissance of an area. The CTD will close on the quarry using the strongest scent-ground borne or wind borne. A CTD can track in or over vegetation, sand, water, concrete, and asphalt. The CTDs are capable of working in urban and rural environments, day or night. If a CTD is required to work at night, a NVD should be provided to the handler, enabling him to see and read the dog's alert. To conduct a successful track, a CTD needs an adequate starting point that is not contaminated with extraneous humans.

## Chapter 5

### Military Working Dog (MWD) Team Readiness

#### Section 5000 - Introduction

5001. Purpose. This section provides an introduction to the methodology utilized within the Marine Corps MWD community to determine that the basic MWD operating element, the MWD team, has achieved a level of performance necessary to effectively perform supported tasks defined in Chapter 4.

"Mission" applies to:

- a. Non-operational support as coordinated through the MWD Scheduling Cell (see paragraph 6304).
- b. Off-base operations that are not considered deployment/combat or covered in a. above.

#### 5002. Readiness Methodology

1. Upon assignment to first duty station, if not already done, the handler will be assigned to form a team that must undergo a qualification process that ensures they are capable of being a safe, reliable and credible asset in the Marine Corps operational environment. Appropriate action will be taken, per procedures in this Manual, and applicable regulations, if either the handler or MWD displays an inability to meet the established standards. This level of performance is evaluated and expressed in terms of "**Readiness**" to meet operational commitments.

2. The MWD team, as with all other Marine Corps operating units, must achieve and maintain a level of Readiness necessary to effectively perform support functions. The combining factors of the individual availability and the team qualification determines the team readiness status as defined in detail within this chapter and as illustrated in figure 5-1.

3. Team assignments will change over time in varying intervals, but with each formation of a new team; the qualification process must progress along a defined timeline to ensure this particular teaming arrangement achieves an acceptable readiness status regardless of the past experience of either the handler or MWD.

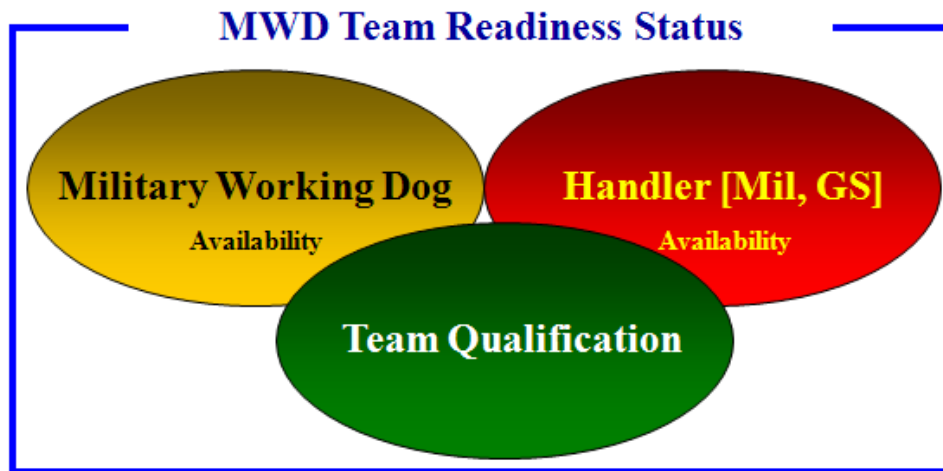

Figure 5-1.--Readiness Factors

5003. Importance of Readiness. Team readiness is the key element in determining the overall MWD section operating status [see paragraph 8300]. It is imperative that each KM ensures that pertinent readiness data is updated per the reporting guidelines of Chapter 8.

Section 5100 - Determining Military Working Dog (MWD) Team  
Readiness

5101. Purpose. This section defines the MWD team readiness categories and the criteria associated with each.

5102. Categories. Table 5-1 provides the definition of the MWD team readiness categories which are determined from data recorded in WDMS using the criteria in table 5-2.

<b>Table 5-1.--MWD Team Readiness Definition</b>	
<b>MWD Team Readiness Categories</b>	<b>Definition</b>
<b>Ready</b>	Team is capable of being assigned to any supporting installation, other agency, and operational force commitments for validated team skills.
<b>Restricted</b>	Team operational use is restricted to performing duties within the specified limitations, due to - * physical or performance issues <u>or</u> * lack of required detection odors <u>or</u> * temporary MWD or handler non-availability
<b>Deployed</b>	Team is currently deployed Outside Continental United States (OCONUS) with an operational force.
<b>Not Ready</b>	Team is not capable of being assigned to any MWD support commitments.

5103. Criteria. MWD team readiness is determined from data recorded in WDMS using the criteria in table 5-2. Limited validations are described in paragraph 5204.3.

Table 5-2.--MWD Team Readiness Criteria

Team Readiness Category		Readiness Factors					Team Qualification Note (2)
		MWD Availability Note (1)		Handler Availability Note (1)			
		Status	Medical Category	Arrival Date	Status	Arrival Date	
Ready		Operational / On Mission Note (3)	1	On Record	On Hand-Unrestricted / On Mission Note (3)	On Record	Note (4)
Restricted - 1		Operational / On Mission Note (3)	1	On Record	On Hand-Unrestricted / On Mission Note (3)	On Record	Note (5)
Restricted - 2		Working Quarantine	1	On Record	On Hand-Unrestricted	On Record	Note (6)
Restricted - 3		Operational / Working Quarantine / On Mission Note (3)	2	On Record	On Hand-Unrestricted / On Mission Note (3)	On Record	Note (6)
Restricted - 4		Operational / Working Quarantine / On Mission Note (3)	3	On Record	On Hand-Unrestricted / On Mission Note (3)	On Record	Note (6)
Restricted - 5		Operational / Working Quarantine / On Mission Note (3)	4	On Record	On Hand-Unrestricted / On Mission Note (3)	On Record	Note (6)
Deployed		Operational / Working Quarantine	1/2/3	On Record	Note (7)	On Record	At least current Basic Skills validation
Not Ready		Deployed			Deployed		
		None of the Above			None of the Above		None of the Above

Note (1) The criteria for MWD and handler determines the availability of a these assets to perform duties.  
 Note (2) The team qualification reflects that the MWD/Handler working unit can meet established performance standards.  
 Note (3) A team employed on an off-base mission [DoD or HMX-1] must have both the MWD and handler assigned to "On Mission" status.  
 Note (4) All required validations are current and none are LIMITED.  
 Note (5) All required validations are current and some are LIMITED [Basic Skills or Detection].  
 Note (6) All required validations are current and some may be LIMITED [Basic Skills or Detection].  
 Note (7) Handler has one of the following Status Codes: • Leave • Medical • On Hand-Unrestricted • Range/Field Duty  
 • Legal • On Mission • On Hand-Restricted

Capability Validations Required by MWD Type			
Priority of Completion	1	2	3
MWD Type	Basic Skills	Patrol	Detection - Explosive
CTD	X		Detection - Drug
DDD	X		Detection - Explosive
EDD	X		X
P/DDD	X	X	X
P/EDD	X	X	X
SSD	X		X

## Section 5200 - Qualification Process

5201. Purpose. This section provides an overview and articulates the qualification process that ensures that the MWD team achieves and maintains the necessary level of readiness.

### 5202. TVC Process

1. Introduction. Successful achievement of the particular team qualification is accomplished in a 3-phase process, termed the **TVC Process** [Training, Validation, Certification] that starts with the handler and trainer developing the team performance and evaluating MWD training through structured events until the team is ready for the KM's evaluation called validation. At the end of a series of multiple training events conducted over several days, the KM/trainer will evaluate the team's performance and award the Validation qualification if all standards are met [the validation standard is consistent with the standard utilized by the original MWD training institution unless associated with approved advanced team training]. If validation testing is not satisfactorily completed, the team must continue training until deemed ready for another validation attempt. Once a team achieves validation and if there is a requirement for supporting probable cause searches; the team is eligible for evaluation by a search granting authority/designee for team certification. The MWD team may receive a limited validation or limited certification for approved MWD performance or evaluation deficiencies.

2. Qualification Timeline. For a newly assigned team, the qualification process progresses along the general timeline illustrated in figure 5-2. Figure 5-3 provides a more detailed overview of the timeline for a first assignment "New Dog" that will transition to the field environment per the activities outlined in table D-3.

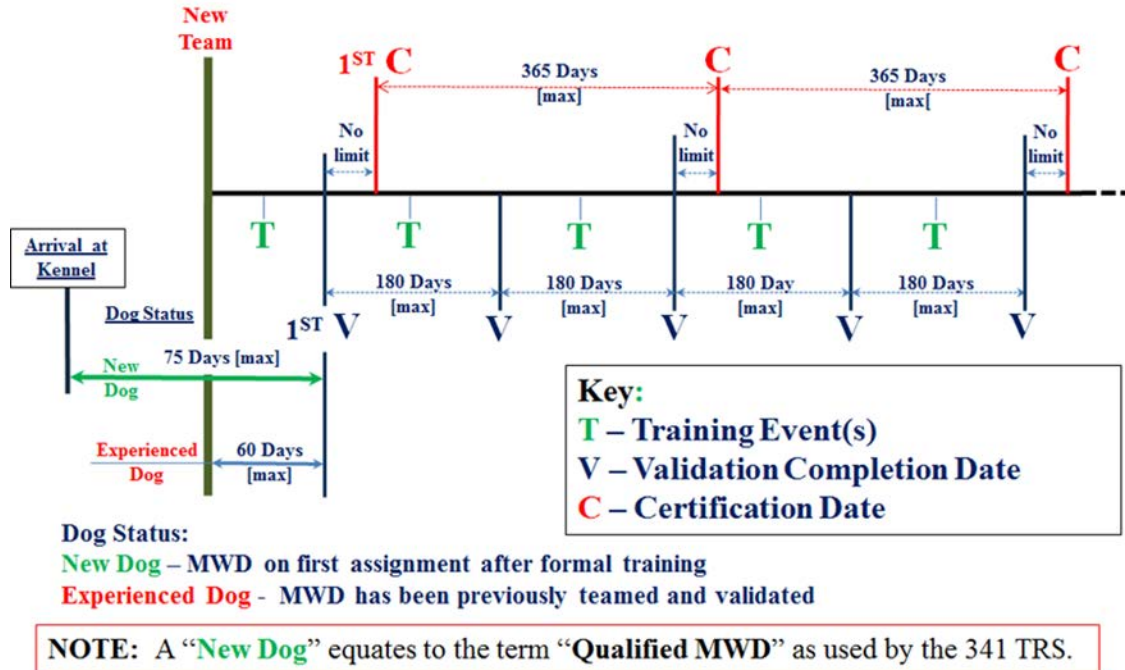

Figure 5-2.--Team Qualification Timeline

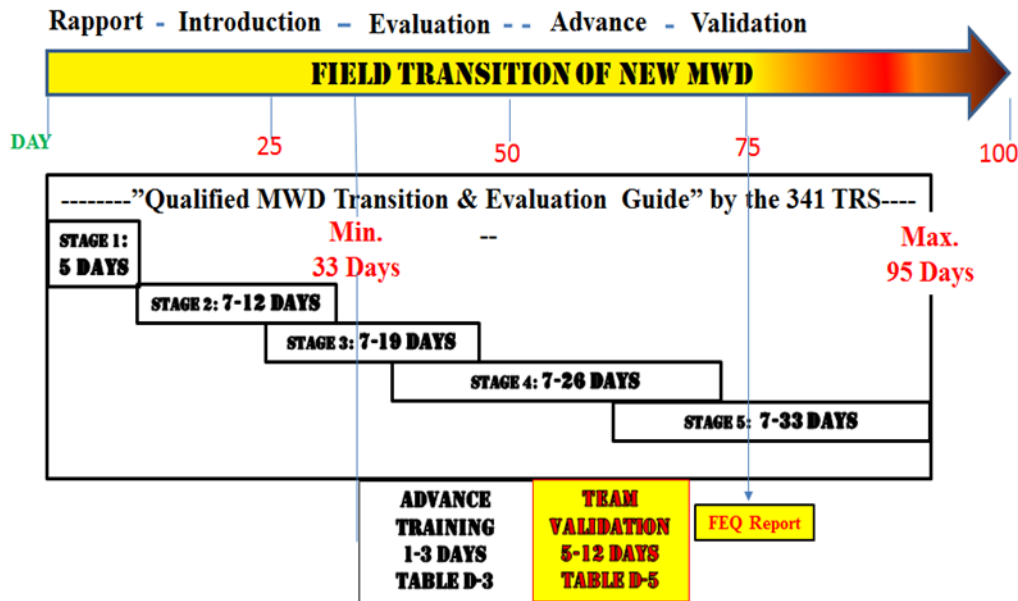

Figure 5-3.--New MWD Field Transition Timeline

3. Recording. The training and evaluation activity is recorded in the Marine Corps module of the DoD WDMS where the data is maintained for record and monitoring purposes. A monthly MWD activity report is generated from WDMS, reviewed and authorized by the KM, and filed in the MWD Service Record to document the team’s compliance with the qualification process.



5203. Training

1. Introduction. An MWD requires continual training to maintain skills necessary to perform required tasks. Without frequent reward reinforcement for correctly performing a task, the MWD will lose its proficiency. Likewise, the ability of the handler to identify and respond to the MWD behavior is lessened. Training assists the handler in evaluating MWD behavior and determining which techniques produce the optimum behavior. Once assigned to a command and assigned to a team, it is the KM's/trainer's responsibility to conduct training to ensure the team is fully capable of meeting the qualification standards provided in Appendix D. When approved, the KM/trainer can conduct additional MWD capabilities training.

2. Types

a. Formal Training. The USAF 341<sup>st</sup> TRS is the primary source for the formal training of MWDs and handlers.

(1) MWD basic level training is evaluated to meet the threshold performance standards, by MWD type, defined in Appendix B.

(2) The basic handler level training is conducted to meet the skill level for the 5812 MOS and the government service designator of 0083 as defined in reference (o).

(3) The PEDDs and PDDDs are trained in separate courses from their handlers at the 341 TRS. The SSD and CTD capability trains the MWD and handler together as a team.

(4) See paragraph 3103 for additional details on formal training courses.

b. Advanced Training. Training of MWDs to enhance skills (e.g., height and depth detection increases, off-leash detection (other than SSD), longer range tracking) that are specified on the MWD form LAFB 375 is classified as "Advanced Training" and is approved under the direction of the KM.

(1) Marine Corps guidance for MWD advanced training is defined by the objective performance standards, by MWD type, in Appendix B.

(2) E-collar. Training with an E-collar is classified as advanced training.

24 FEB 2020

(a) The E-collar user must be documented to have successfully completed an MWD PM approved course of instruction (see paragraph 3105.1).

(b) E-collar training at the initial formal school should be annotated on the LAFB 375.

(c) Appendix G has additional guidance on use of the E-collar.

(d) All E-collar use must be documented in WDMS [basic skills comments].

c. Additional Training. Training of MWDs to perform skills [e.g., patrol, tracking, odor detection, non-standard command/signals] that are not specified on the LAFB 375 is classified as "Additional Training" and is prohibited unless specifically approved in advance by the MWD PM [see Appendix C].

(1) Requests will include operational requirements, a training plan, and designation of qualified trainers.

(2) Completed authorized additional training is to be annotated in the MWD form DD 1834 per instructions in Appendix E.

(3) The MWD NSN must also be changed per instructions provided by the MWD PM.

d. Cadaver Detection Training. Per the Joint Service MWD Committee (JSMWDC) agreement, MWDs will not be trained in cadaver training. Outside contractor services will be utilized if this capability is required. Local command action is required to acquire such services.

e. On-The-Job Training (OJT). See paragraph 3106.

### 3. Training Equipment

a. Types. Training equipment is an item used during the course of a training event to enhance the effectiveness of the qualification process. A wide variety of training equipment is essential in the development and maintenance of the MWD capabilities. In some cases, the item used during training is the same equipment that will be used in the team's operational activity; e.g., SSD radio, E-collar. Additional information on this equipment is provided in Chapter 9.

b. Changing MWD Reward. The MWD reward is determined during initial training and noted on MWD Service Record form DD 1834. The selected reward reinforces the MWD's behavior. Although the MWD may appear to be motivated by another reward, the motivation usually is not sustained and will negatively affect performance. If the KM determines the need to change the MWD reward, the KM should:

(1) Screen the MWD training record for previous reward difficulties.

(2) Note the reward change on the DD 1834, Military Working Dog Service Record, per the guidance provided in Appendix E.

c. Drop Aids. Reinforcement training aids are drug/explosive training aids (also known as "Drop Aids") that are used to reinforce MWD search behavior during detection utilization activities. Refer to following chapters for details about the configuration and control of drop aids: Chapters 11 (Drug) and 12 (Explosive).

#### 4. Training Management

a. Concept. The KM has the overall responsibility for managing MWD training. In turn, the trainer coordinates and supervises the training activities with particular focus on creating an effective handler/dog team. The first step in training management is to evaluate the team's abilities to meet the published Marine Corps qualification standards. Once deficiencies are identified and goals established, the trainer has to solve the "WHEN-WHERE-WHY To Train" challenges. A key element to qualification success is developing the team training plan, called the OTP, in which the trainer defines the team's monthly training objectives. This plan is in turn incorporated into the MWD section training schedule to ensure effective use of training assets and to minimize activity conflicts. The handler is responsible to accurately record the team training activity into WDMS. The MWD section uses WDMS administrative tools to monitor training activities and evaluate trends in the team performance.

b. When to Train. Training should be conducted during the handler's normal shift to prevent loss of proficiency and to meet the qualification standards stated in Appendix D.

24 FEB 2020

c. Where to Train. Training events should be conducted in areas that closely simulate the operating environment.

d. Why to Train. Team training is a complex combination of maintaining learned individual handler and MWD skills, building a solid team working relationship conducive to effective performance, building endurance, and enhancing skills to meet operational requirements. It is the KM's responsibility to ensure the handler is fully capable of using the established training and troubleshooting techniques described in Appendix G. Important factors are the quality of training and the length of time elapsed between task performances.

e. Optimum Training Plan (OTP). The KM and/or trainer and handler will develop the OTP which identifies the most effective training needed to meet the qualification standards stated in Appendix D. Training activities may exceed the guidance provided depending on operational commitments, the requirement to meet the validation timeline for newly assigned teams, or to avoid a lapse in an existing qualification [see paragraphs 5204 and 5205]. The OTP can be generated in WDMS where it is visible to the handler and the MWD section along with the option to print copies. The OTP should be reviewed at least monthly and adjusted as necessary to achieve and maintain the required team performance. Refer to the user manual in the WDMS library for instructions on using the training plan feature.

f. MWD Section Training Schedule. Each MWD section has a number of training activities other than those that are MWD related; e.g., essential subjects, vehicle operator, security skills, weapons, professional development, explosive qualification. To best coordinate these requirements and to ensure effective use of training facilities, each MWD section should publish a monthly training schedule per command requirements. When developing the schedule, the trainer should consider the following methods to schedule effective team training:

(1) Consolidate team detection events on dates to minimize logistics involved in obtaining and transporting the scent kits.

(2) Schedule certification events to coincide with the last validation event.

(3) Use demonstrations to meet training requirements (see paragraph 5203.5).

24 FEB 2020

g. Training Assistance. MWD sections may encounter training deficiencies beyond the scope of the KM/trainer's ability to resolve. Kennel Masters are encouraged to request training assistance from the MWD PM [see Appendix C]. The request must thoroughly describe the deficiency, corrective action taken to date and the impact on section operating status. Team performance issues shall be thoroughly reported in WDMS.

5. Demonstrations. Demonstrations provide good public relations, psychological value, and encourage handlers to maintain highest level of team proficiency. Also, MWD sections are encouraged to conduct demonstration/briefs to non-MWD personnel to ensure all security personnel understand the MWD team capabilities and the nature of support provided.

a. Appendix J is a guide on conducting demonstrations to both military and public audiences.

b. The level of detail explanation about MWD training techniques and detection capabilities must be tailored to the audience's need-to-know about sensitive information.

c. A demonstration is recorded as such in WDMS [as a Basic Skill activity] on the appropriate date. Refer to the user manual in the WDMS library for further instructions.

d. Demonstrations are reported in the monthly MWD activity report.

6. Competitive Events. MWD teams should be encouraged and allowed to participate in competitive events, seminars, or conferences conducted by outside agencies or police canine organizations. Exposure to competitive events can challenge MWD teams to develop skills or learn advanced employment and training techniques.

a. Refer to paragraph 5203.2c (Additional Training) since training restrictions may apply.

b. This type of event shall be recorded in WDMS as training.

7. Training Record Keeping. In a timely manner based on operational commitments, each handler and/or trainer will ensure all training events are recorded in WDMS and reported per the instructions to follow.

a. Rating. Training events will be rated in WDMS by the individual specified in table 5-3. Ratings are subjective [Satisfactory/Unsatisfactory] and are based on the evaluator's determination of the team's performance trends against the qualification requirements in Appendix D.

<b>Table 5-3.--WDMS Training Evaluation</b>		
<b>TYPE</b>	<b>MWD APPLICATION</b>	<b>RATING BY (1)</b>
<b>Basic MWD Skills</b>	All	Handler
<b>Drug Detection</b>	DDD PDDD	KM/Trainer
<b>Explosive Detection</b>	EDD PEDD SSD	KM/Trainer
<b>Patrol</b>	Patrol (P)	Handler
<b>Tracking</b>	CTD	KM/Trainer
<b>NOTES:</b>		
<b>(1) Rates for the team qualification activity. Kennel Master can enter rating in absence of a trainer.</b>		

b. Recording. The results of the training activity will be recorded, along with other qualification data, in the monthly MWD Activity Report [NAVMC 11818-1] as described in Appendix E.

c. Reporting. A monthly MWD Activity Report [NAVMC 11818-1] will be generated for each MWD assigned to the MWD section. This report shall be reviewed for accuracy and signed by the KM and supervisor/trainer. The signed monthly report will be maintained in the MWD Service Record per the record maintenance guidelines in Chapter 8.

#### 5204. Validation

**NOTE:**

The effective start date of a capability validation is the date of the last event conducted in a successful validation

1. Introduction. Validation is a management tool for the Marine Corps to establish the effectiveness of MWD teams, whether assigned at an installation or with operational forces. It can be conducted in garrison or by the KM or trainer of a deployed task organized MWD unit.

2. Successful Validation. Team validation constitutes the successful completion of all the capability validations required

by MWD type as defined in table 5-2. Unless otherwise noted, the policy in this section relates to each of the required capability validations. A team will not have the same effective start and end dates for most required validations, but the Marine Corps requirement is that the team is current at any point in time after the initial team assignment period as illustrated in figure 5-4. If one capability validation is classified as a limited validation due to a deficiency described in this section, the MWD team can still achieve a successful validation and an acceptable operational readiness.

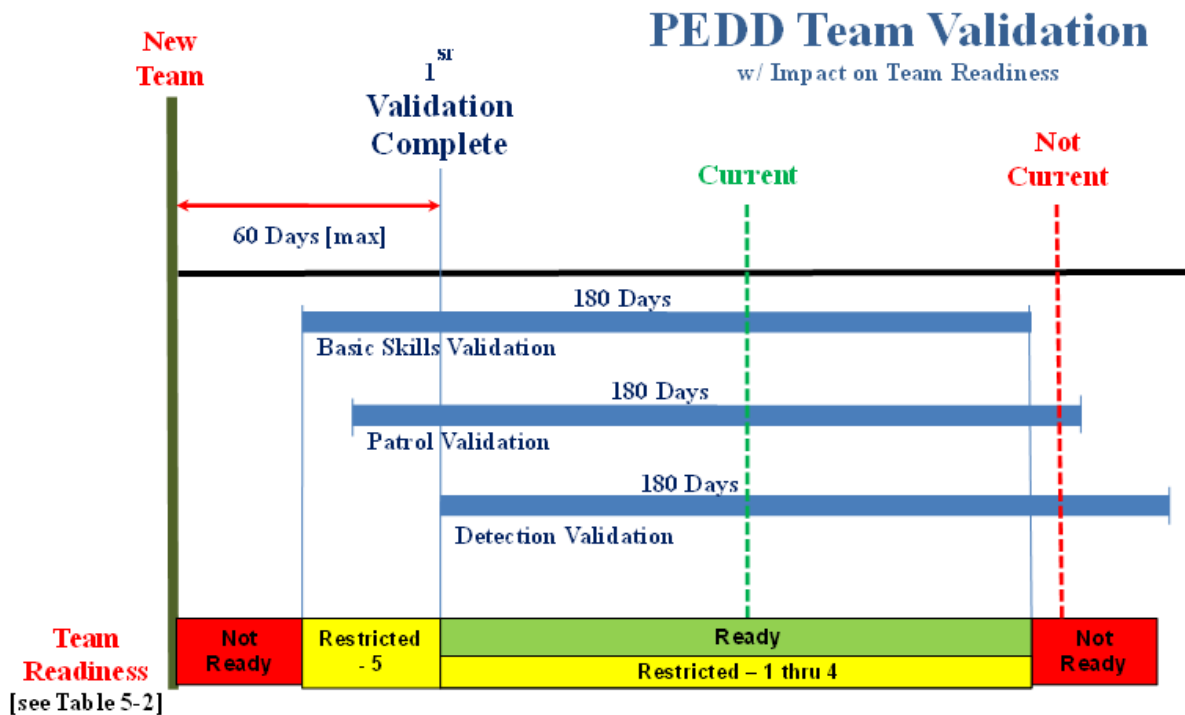

Figure 5-4.--Example Team Validation Timeline

3. Limited Validation. The MWD team may receive a limited validation only in those capability validations for the reasons described in table 5-4. The "LIMITED" status is automatically designated on the appropriate WDMS generated validation report and included in the MWD team readiness as defined in table 5-2. The limited status is removed when a new validation is conducted once the stated reasons have been corrected.

Table 5-4.--Approved Reasons for Limited Validation	
Capability Validation	Approved Reason for LIMITED Status
Basic Skills	Documented Medical Waiver for qualification events: <ul style="list-style-type: none"> <li>• Obstacle Course <u>and/or</u></li> <li>• Gunfire</li> </ul>
Detection	Documented shortage of required training aid odors: <ul style="list-style-type: none"> <li>• Drug</li> <li>• Explosive</li> </ul>

4. Conduct of Validation. Team validation will be conducted per the timeline illustrated in figure 5-2, the standards and guidelines provided in Appendix D and the following instructions:

a. Newly arrived MWD (New Dog from any formal training program) at an MWD section shall complete all capability validations within 75 calendar days of assignment to the section. See section 5300 for corrective action.

b. A new team, consisting of an experienced MWD [previously teamed and validated], shall complete all capability validations within 60 calendar days of the team assignment date. See section 5300 for corrective action.

c. A capability validation is considered current for a period of 180 calendar days. See exceptions in paragraph 5204.6&8.

d. It is important to schedule the capability validations in sufficient time to avoid a negative impact on the team's readiness as illustrated in figure 5-4.

e. Event Restrictions. The capability validation is restricted to 12 calendar days during which the necessary events [limitation as defined in table 5-5] are to be conducted, recorded, and the completed validation reported in WDMS as illustrated in figure 5-5. Submit a WDMS trouble ticket for assistance in recording an event that is beyond this restriction.



Table 5-5.--Validation Event Limitation	
Capability Validation	Event Limit (1)(2)
Basic Skills	3
Patrol	5
Detection [Drug & Explosive]	5
Tracking	4

**NOTES:**

(1) Event is a single validation activity recorded in WDMS [e.g., recording passing the obstacle course on day one and the passing obedience tasks on day two constitutes two events toward the Basic Skills validation]. Events are conducted and evaluated per Appendix D.

(2) Events recorded in WDMS as validation, but not selected for the final validation report, must be revised to "Training" events to ensure proper recording in the MWD activity report.

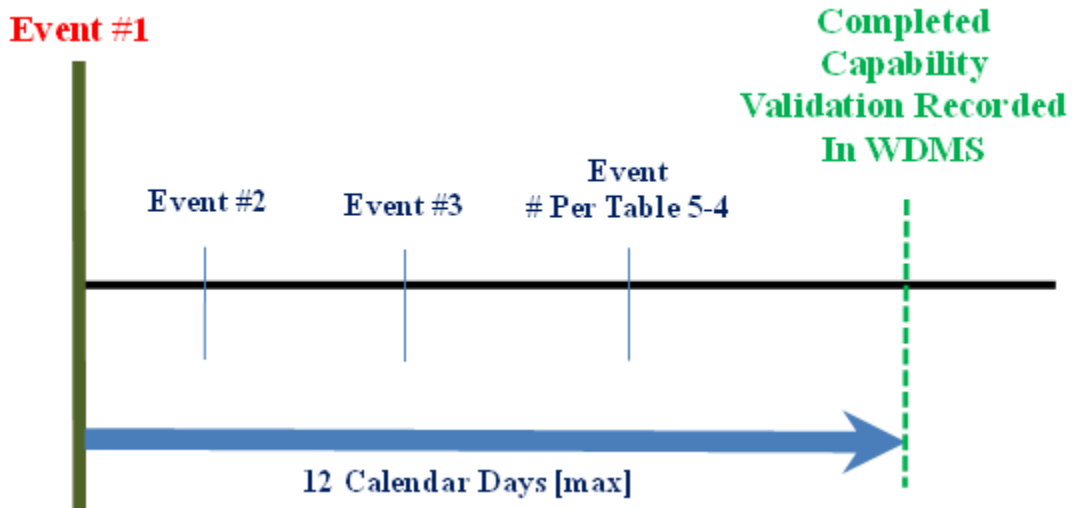

Figure 5-5.--Validation Completion Timeline

f. Prerequisites. The validation process is structured to evaluate the team's capabilities starting with the elementary functions included under Basic Skills up to the most complex tasks of detection/tracking. Table 5-6 specifies the prerequisite criteria that must be accomplished in advance of completing and recording a capability validation.

Table 5-6.--Capability Validation Prerequisite Criteria	
Capability Validation	Criteria
Basic Skills	No criteria - can be conducted and recorded at any time.
Patrol	Team must have current Basic Skills Validation
Detection [Drug & Explosive]	Team must have - Current Basic Skills Validation <b>and either</b> • Detection training event within past <u>15 calendar days</u> • <b>or</b> current Detection Validation
Tracking	Team must have - Current Basic Skills Validation <b>and either</b> • Tracking training event within past <u>15 calendar days</u> • <b>or</b> current Tracking Validation

5. Change of Kennel Master. There is no requirement to conduct new validations upon the assignment of a new KM, but new KMs shall closely observe the performance of all teams and revoke validations and/or conduct new validations as deemed necessary per the criteria of paragraph 5204.7.

6. Deployed MWD Teams. Upon arrival in theater, MWD teams should conduct acclimation and training activities prior to being considered operational in of the area of operations (AO). The training will introduce the team to the various types of odors that are a threat in the AO. Odor imprinting should be conducted by a USMC KM or trainer. In addition, the training period will enable the team to become acclimatized to the environment. The following instructions apply for deployed MWD teams:

a. All team validations shall be current at the time of departing from the parent MWD section to deployment.

b. All of the team validations remain current during a deployment even if the 180 calendar day effective period is exceeded and appears expired in WDMS.

c. Returning deployed teams should achieve current validation status within 90 calendar days upon return to the MWD section.

24 FEB 2020

7. Criteria for Revoking a Validation. An MWD team validation will be immediately revoked and annotated in WDMS by the KM when any one of events in table 5-7 occurs.

<b>Table 5-7.--Criteria for Revoking Validation</b>	
<b>Capability Validation</b>	<b>Criteria (1)(2)(3)(4)</b>
<b>Basic Skills</b>	<ul style="list-style-type: none"> <li>• When MWD team does not meet the capability training standards for a validated team per table D-4B <u>except</u> the physical conditioning guideline under Basic Skills.</li> <li>• MWD team compliance with the above criteria will be evaluated at the end of each month.</li> </ul>
<b>Patrol</b>	
<b>Detection (Drug)</b>	
<b>Detection (Explosive)</b>	
<b>Tracking</b>	<ul style="list-style-type: none"> <li>• When team is separated for <u>30</u> consecutive calendar days.</li> <li>• When a TAD team does not achieve validation after a grace period granted after return to their MWD section [see paragraph 5204.8].</li> <li>• When KM decides the team is no longer validation qualified as evidenced by declining performance during training and utilization activity.</li> </ul>
<b>Any</b>	
<b>NOTES:</b>	
(1) Refer to paragraph 8105 for <b>revoking a validation report</b> in the MWD Service Record.	
(2) <b>Exceptions to these criteria</b> are in paragraph 5204.6 [Deployment] & 8 [Mission TAD].	
(3) Use the KM's TVC report in WDMS to monitor the team status against the criteria for revoking a validation.	
(4) <b>If a required odor is not available</b> , complete a non-availability letter per paragraph 8105.4. Revoking of the validation is not required.	

8. Exceptions for Military Working Dog (MWD) Team on Mission. All validation end dates for teams with "on mission" status will be considered extended till the end of the mission.

a. Returning TAD teams, whose validation expired during TAD, can be granted a 30 calendar day grace period, at the discretion of the KM. During this grace period, the team validation will remain current for purpose of continuing support of installation operations. All team validations must be current at the end of the grace period.

b. Refer to Chapter 8 for annotating a validation grace period in the MWD Service Record.

9. Validation Record Keeping. In a timely manner, KM and/or trainer will ensure all validation events are recorded in WDMS and reported per the instructions to follow:

a. Rating. Evaluator rating is not required in WDMS for detection and tracking validation events.

b. Recording

(1) Handler. The handler shall record validation events in WDMS, per Chapter 8 and the current system operator's manual.

(2) KM/Trainer. The KM or trainer will record in WDMS the date of the successful completion [per paragraph 5204.3] of the validation by identifying the event(s) conducted. Team qualification is an important factor in determining both the team readiness and the MWD section operating status so it is required that the completed validation be reported in WDMS.

(3) Trouble Ticket. A WDMS trouble ticket should be submitted if there are any problems in updating a validation.

c. Effective Date. The effective start date of a validation is the date of the last event conducted in a successful evaluation process.

d. Reporting

(1) Validation Report. A signed copy of the following required current validation reports will be completed and maintained in the MWD Service Record per Chapter 8 and Appendix E:

- NAVMC 11818-19 (Basic Skills Validation)
- NAVMC 11818-20 (Patrol Validation)
- NAVMC 11818-21 (Detection Validation)
- NAVMC 11818-22 (Tracking Validation)

(2) Activity Report. The results of the validation events will be reflected in the monthly MWD Activity Report [NAVMC 11818-1] as described in Appendix E.

10. Medical Waiver. Both table 5-4 and Appendix D discuss the types of authorized medical waivers that will allow an MWD to be

permanently excluded from holding a successful validation in a required event.

5205. Certification

**NOTE:**

The effective start date of a certification is the date of the successful demonstration to the search granting authority/designee.

**IMPORTANT:**

There is no separate CTD certification process. CTD team will only have to be validated in all required skills to be qualified to track criminal suspects on a military installation.

1. Introduction. Certification is an annual odor recognition test used to formally demonstrate and document, for legal purposes, those MWD detection teams that are required to support searches authorized by the search granting authority/designee. The certification will be classified as a limited certification when there is a deficiency as described in this section.

2. Conduct of Certification. Team certification will be conducted per the timeline illustrated in figure 5-2, the standards and guidelines provided in Appendix D and the following instructions:

a. Certification is considered current for a period of 365 calendar days.

b. A team must have a current certification and a signed certification report [NAVMC 11818-23 (Detection Certification)] in the MWD Service Record, before being assigned to perform any detection utilization.

c. It is important to schedule the certification event in sufficient time to avoid expiration of the team certification and interrupting support of probable cause searches.

d. Event Restrictions. The team certification process is restricted to 12 calendar days during which a limit of no more than four events are to be conducted, recorded, and the completed certification reported in WDMS [similar to the timeline illustrated in figure 5-5 for validation].

e. Prerequisites. Certification can be conducted at any time as long as the team detection/tracking validation is current prior to the effective start date of the certification.

3. Change of Search Granting Authority. Another team certification should be conducted within 60 calendar days of a change in the search granting authority (designee). A copy of the letter of continuity (generated per command SOP) from the new search granting authority (designee), included in the MWD Service Record, will suffice to maintain team detection certification.

4. Criteria for Revoking Certification. The team certification will be immediately revoked and annotated in WDMS by the KM when any one of events in table 5-8 occurs. Refer to Chapter 8 for revoking a certification report in the MWD Service Record.

<b>Table 5-8.--Criteria for Revoking Certification</b>	
<b>Certification Type</b>	<b>Criteria</b>
Drug / Explosive Detection	<ul style="list-style-type: none"> <li>• When the team does not have a current signed detection validation report in the MWD Service Record.</li> </ul> <p><b>OR</b></p> <ul style="list-style-type: none"> <li>• When the search granting authority/designee decides that the team is no longer reliable to conduct probable cause searches.</li> </ul>

5. Non-availability of Training Odor. The KM will submit a signed letter to the search granting authority when a certified odor is no longer available for training. A copy of this letter will be included in the MWD Service Record. Refer to Chapter 8 for processing a notice of non-availability of a training aid. The lack of an odor will result in a limited certification (see paragraph 5205.8).

6. Exceptions for MWD Team on Mission or Deployment. To minimize the administration impact of returning teams who still have current certifications, but have exceeded the criteria for revoking the certification (see paragraph 5205.5), the returning team can be granted a 30 calendar day grace period, at the discretion of the KM and the search granting authority, to be exposed on all certified odors upon return to their MWD section. During the period, the team will be considered to be certified for the purpose of conducting installation probable cause searches. Refer to Chapter 8 for annotating a certification grace period in the MWD Service Record.

7. Certification Record Keeping. Kennel master and/or trainer will ensure all certification events are recorded in WDMS and reported per the following instructions.

a. Search Granting Authority. The search granting authority is authorized to certify drug and explosive detector MWDs. The search granting authority may delegate this authority to a subordinate, i.e., the PM/PC, without diminishing the reliability of the MWD team. In such cases, the subordinate to whom the search granting authority has delegated this authority must witness the required demonstration, and attest to the results in writing. While the actual delegation of authority need not be in writing, the subordinate to whom the authority has been delegated should sign the certification report "By direction" of the search granting authority. PM/PCs are strongly encouraged to establish this arrangement with their respective search granting authority.

b. Rating. Evaluator rating is not required in WDMS for detection certification events.

c. Recording

(1) Handler. The handler shall record certification events in WDMS, per Chapter 8 and the current system operator's manual.

(2) Kennel Master/Trainer. The KM or trainer will record in WDMS the date of the successful completion [per paragraph 5205.3] of the certification event by identifying the event(s) conducted. Team certification date is an important factor in determining the legal status for probable cause searches so it is required that the completed certification be reported in WDMS.

(3) Trouble Ticket. A WDMS trouble ticket should be submitted if there are any problems in updating a certification.

d. Effective Date. The effective start date of a certification is the date the certification event was conducted.

e. Reporting

(1) Certification Report. A signed copy of the current certification report [NAVMC 11818-23 (Detection Certification)], as generated by the KM in WDMS, will be completed and maintained in the MWD Service Record per Chapter 8 and Appendix E.

(2) Activity Report. The results of the certification event will be reflected in the monthly MWD Activity Report [NAVMC 11818-1] as described in Appendix E.

8. Limited Certification. The MWD team may receive a limited certification when there is a documented shortage of required drug or explosive training aids. The "LIMITED" status is automatically designated on the appropriated WDMS generated certification report. The limited status is removed when a new certification is conducted with all required training aids. The MWD team can still perform probable cause searches with a limited certification. Normally, a limited certification is associated with the MWD team having a limited detection validation and a restricted readiness category.



Section 5300 - Failure to Maintain Military Working Dog (MWD)  
Team Readiness

5301. Purpose. This section articulates the corrective actions when an MWD team fails to achieve or maintain the necessary level of readiness.

5302. Corrective Action. If an MWD team is not expected to be validated within the timeline of table 5-2, the KM shall consider the following actions based on the source of the performance issue:

1. Handler Issue

- a. Terminate the team and reassign MWD to a new handler.
- b. Request training assistance from the MWD PM per instructions in Appendix C.

2. Military Working Dog (MWD) Issue. Once it has been confirmed that a handler performance issue is not the cause of the problem, the following action applies:

a. New Dog [see figure 5-2]

(1) If the team is not progressing satisfactorily by 45 calendar days after the arrival of the MWD to the kennel, the KM shall alert the MWD PM (see Appendix C) of the discrepancies and corrective action. The MWD PM will in turn alert the formal training institution.

(2) Field Evaluation Questionnaire (FEQ). The FEQ is a joint service MWD management tool within WDMS to provide constructive feedback on the quality of MWD training by the 341 TRS and the MWD integration process at the receiving command.

(a) The KM shall complete the FEQ within 75 calendar days of the MWD arrival at the command.

(b) The digital FEQ is available in the WDMS KM/MWD Management tab on the shipment date and includes instructions.

(c) The status of pending FEQs is reported in the WDMS KM dashboard and the detailed report.

(d) All FEQs submitted after 1 March 2013 are available to KM/trainer access from the WDMS KM reports using the MWD brand.

b. Experienced Dog [see figure 5-2]

(1) Terminate the team and reassign a new handler if the MWD does not effectively respond to the current handler.

(2) Via the chain-of-command, request training assistance from the MWD PM per instructions in Appendix C.

(3) Initiate a disposition package or change of NSN per the instructions in Chapter 7.

## Chapter 6

### Military Working Dog (MWD) Team Employment

#### Section 6000 - Concept of Employment

6001. Purpose. This section provides a concept overview of the employment of MWD teams along with pertinent definitions used within this chapter.

- **"Team Employment"** applies to the application of the MWD skills during all missions (force protection, security, and combat support), whether patrolling, detecting drugs or explosives, tracking, performing other functions (in combination) or providing a deterrence presence.
- **"Utilization"** is the term used in this manual to encompass all forms of employment to include associated duties (i.e., travel, standing post) as it is recorded in WDMS.

6002. Introduction. Figure 6-1 illustrates the five employment scenarios a Marine Corps MWD team may encounter depending on whether the handler is military or civilian. Each handler is a qualified military policeman/police officer who is afforded authority to conduct LE operations with an MWD on a Government installation. While off the installation, the authority is restricted and will be defined further in this chapter. Within a defined U.S. compound, the MWD team will operate the same as on a Government installation, but OCONUS and outside the compound, the team operates under restricted LE authority and Rules of Engagement (ROE) for theater of operations. Many employment considerations are common to all scenarios with those exceptions noted within this Chapter.

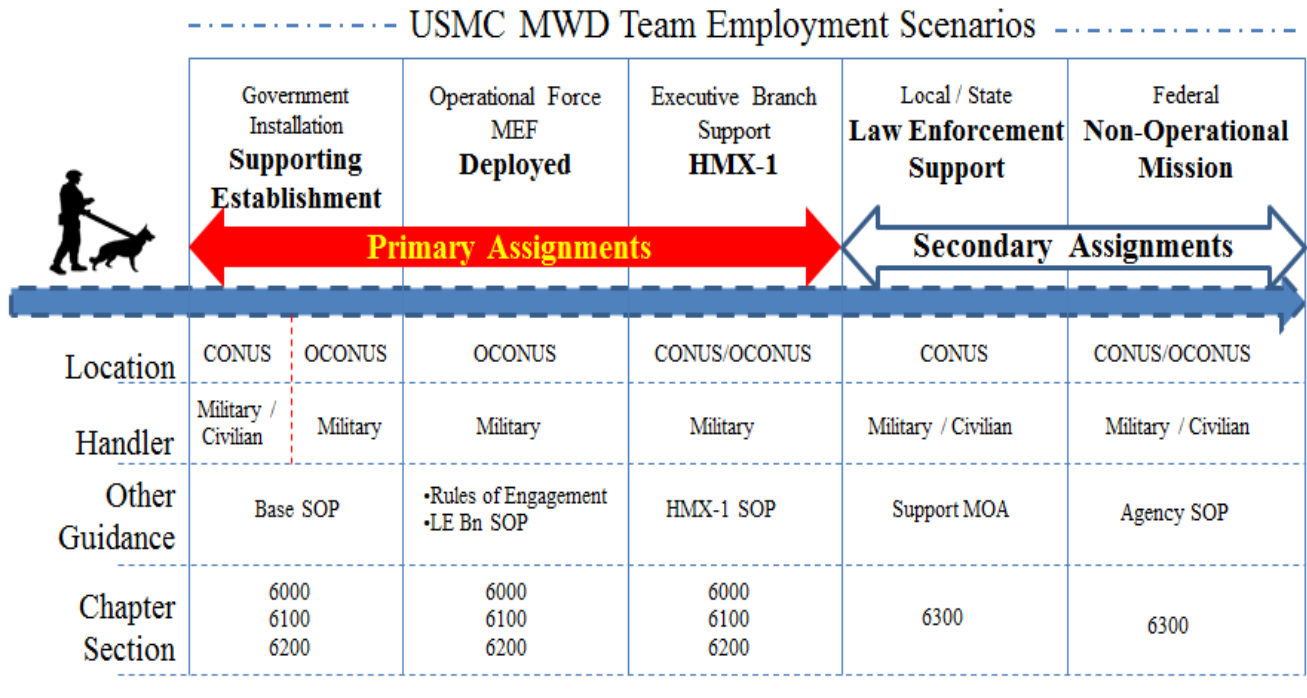

Figure 6-1.--USMC MWD Team Employment Scenarios

6003. Standard Operating Procedures (SOP). Each Provost Marshal (PM)/Police Chief (PC) and LE Bn commander will establish command SOPs that address the local application of the employment guidelines provided in this Chapter. This SOP will be an integral element of the MWD section operations binder [see Appendix F]. Sample procedures are provided in the WDMS library.

6004. MWD Team Activities. MWD team activities will vary by the following categories of assignments as identified in figure 6-1 [all MWD team activities are recorded in WDMS]:

1. Primary. Defined as the MWD section [see figure 2-2] to which the handler and MWD fill a line within the T/O and T/E. Team activities are described below by the type of organization:

a. Utilization is the primary focus for qualified MWD teams. Refer to paragraph 8104 for guidelines on qualification and utilization activities.

b. Supporting Establishment. While supporting operations on board their assigned installation, MWD teams will directly support the PM/PC by supporting operational tasks defined in table 6-1 for the applicable MWD capability and promoting

positive community relations through demonstration of skills. MWD teams will support the PMO/MCPD watch with the following duties:

(1) Report for duty in conjunction with their assigned security watch for weapons issue, vehicle assignment, roll call training, and watch commander's brief.

(2) Respond to calls, complete paperwork, process evidence and prisoners, and conduct other patrol functions as required by the watch commander.

(3) Inform watch commanders of the particular MWD capabilities and limitations.

(4) Conduct security checks while on patrol.

(5) Support non-duty hour kennel security checks (see paragraph 9106).

c. Law Enforcement Battalion (LE Bn). LE Bn MWD teams support operational tasks in table 6-1. When not operationally assigned, LE Bn MWD team training hours should increase per subparagraph 8104.1.d. These MWD teams can be attached to support other service deployment requirements on receipt of a Request for Forces (RFF) and the approval of the combatant commander (COCOM). Reference (p) provides further guidance into the war fighting role of the MWD section.

d. HMX-1. The HMX-1 MWD section is tasked to provide counter-terrorism explosive detection at the squadron permanent facilities at MCB Quantico, VA and at any destination Government or civilian facility when the HMX-1 Squadron transports the Executive Branch.

2. Secondary. Secondary MWD team assignments are conducted on an as-required basis and only if it does not cause an operational conflict with the accomplishment of the team's primary assignment. As a rule, the following type of employment scenarios will be accomplished by supporting establishment MWD teams per section 6300:

a. Civilian LE support

b. Federal Non-Operational missions

6005. Supported Tasks. The supported commander through consultation with the KM shall select the MWD capability combination that best supports the mission tasks as specified by MWD type in table 6-1 below:

<b>Table 6-1.--MWD Team Operational Supported Tasks</b>					
<b>Operational Task</b>	<b>MWD Functions</b>	<b>Assignment By Type MWD</b>			
		<b>PDDD</b>	<b>PEDD</b>	<b>SSD</b>	<b>CTD</b>
Aircraft, Vessel and Luggage Search	Drug Detection Expl. Detection	X	X	X	
Antiterrorism / Force Protection (AT/FP) Efforts	Expl. Detection Patrol	X	X	X	
Area Search	Drug Detection Expl. Detection Patrol	X	X	X	
Area / Perimeter Security <ul style="list-style-type: none"> <li>• External intrusion detection</li> <li>• Listening Posts (LP)</li> <li>• Observation Posts (OP)</li> <li>• Vulnerable Area</li> </ul>	Patrol	X	X		
Bomb Threat	Expl. Detection		X	X	
Building Search <ul style="list-style-type: none"> <li>• Illegal Substance</li> <li>• Personnel</li> </ul>	Drug Detection Expl. Detection Patrol	X	X	X	
Checkpoint Support <ul style="list-style-type: none"> <li>• Entry Control Point (ECP)</li> <li>• Random Gate Inspection</li> <li>• Vehicle Control Point (VCP)</li> <li>• Vehicle Search</li> </ul>	Drug Detection Expl. Detection Patrol	X	X	X	
Civil Disturbances/Crowd Control	Patrol	X	X		
Combat Patrols <ul style="list-style-type: none"> <li>• Census</li> <li>• Contact</li> </ul>	All	X	X	X	X
Command Post Area Preparation	Expl. Detection		X	X	
Cordon & Knock (C&K)	Expl. Detection Patrol Tracking	X	X	X	X
Deployment Customs Search (Pre/Post)	Drug Detection Expl. Detection	X	X	X	
Enemy Prisoner of War (EPW) Support	Patrol	X	X		

24 FEB 2020

<b>Table 6-1.--MWD Team Operational Supported Tasks</b>					
<b>Operational Task</b>	<b>MWD Functions</b>	<b>Assignment By Type MWD</b>			
		<b>PDDD</b>	<b>PEDD</b>	<b>SSD</b>	<b>CTD</b>
Health and Comfort Inspections • Barracks • Work Area	Drug Detection Expl. Detection	X	X	X	
High Risk Personnel (HRP) Support • Fund Escort • Security Escort	Patrol	X	X		
High Risk Target (HRT) Support	Expl. Detection Tracking		X		X
Locating Individual • Escaped Prisoner • Fleeing Criminal Suspect • Fleeing Enemy Attacker • Hostage • Downed Pilot • Lost Person • Missing-in-Action • Survivors • IED Maker • IED Planter	Patrol Tracking	[Scouting] X	[Scouting] X		X
Military Police Investigations	All	X	X	X	X
Postal Inspection	Drug Detection Expl. Detection	X	X	X	
Protective Service Mission	Expl. Detection		X	Not Preferred	
Quick Search (SNAP)	Expl. Det		X	X	
Raid	Expl. Detection Tracking Patrol	X	X	X	X
Quick Response Force (QRF)	All	X	X	X	X
Securing Area for Downed Aircraft	Patrol	X	X		
Supply Route Search • Main (MSR) • Alternate (ASR)	Expl. Detection Tracking		X	X	X
U.S. Customs Search	Drug Detection	X			
Walking and Mobile Patrol	All	X	X	X	X

6006. Definitions. An abbreviated definition is provided for the following key terms used in this chapter as they apply to MWD operations [for further details see references (n) and (r)]:

1. Competent Authority. Superiors in the chain-of-command and those who are specifically designated in writing to issue orders to law enforcement and security personnel.

2. Continuum of Force. The concept that there is a wide range of possible actions ranging from voice commands to application of deadly force that may be used to gain and maintain control of a potentially dangerous situation.

3. Deadly Force. That force which a person uses with the purpose of causing death or serious bodily harm or which a reasonable and prudent person would consider likely to create a substantial risk of causing death or serious bodily harm.

4. Deterrence. The following types of measures can be taken by the MWD team to prevent possible illegal, disruptive or hostile action by individual(s).

a. Passive. MWD team is present in an area [walking or mobile patrol], but not focused on a particular individual or group. MWD is on-leash and/or behind a barrier. Individual activity suppressed to avoid anticipated encounter with any MWD, regardless of capabilities.

b. Active. MWD team is focused on a particular individual(s) due to an imminent threat or illegal action. Examples are a patrol MWD guarding a suspect; a drug detection MWD searching barracks rooms, an explosive MWD responding to a bomb threat; a CTD tracking a suspected bomb planter.

5. Mission. Within this Order, this term applies to either of the following:

a. Non-operational support as coordinated through the MWD Scheduling Cell [see paragraph 6304].

b. Off-base operations that are not considered deployment/combat or those covered in a. above.

6. Probable Cause. In order to apprehend or detain, conduct lawful searches incident to investigation of an alleged crime, and lawfully seize evidence of such crimes, a MP/police officer must have probable cause to justify their actions. Probable cause is determined by a two-step process:



24 FEB 2020

a. The handler must have a reason to believe that a crime has been committed based on the MWD response to a target sight, sound, odor [drug, explosive, human].

b. The handler must have a reason to believe that the person being apprehended or detained committed that crime. Probable cause requires more than mere suspicion, but does not require evidence beyond a reasonable doubt, which is necessary for conviction of the offense.

7. Rules of Engagement (ROE). Directives issued by competent military authority that delineate the circumstances and limitations under which United States forces will initiate and/or continue combat engagement with other forces encountered. The standing ROE establishes fundamental policies and procedures governing the actions U.S. forces are to take during all military operations and contingencies and routine Military Department functions.

Section 6100 - Legal Considerations

6101. Purpose. This section outlines and articulates the policies and fundamental areas of concerns about legal considerations associated with the employment of MWD teams.

6102. Considerations. The use of MWDs has the same legal considerations as the use of a military/civilian policeman. Each situation and location may be subject to various Status of Forces Agreements (SOFAs), general orders, and other legal restrictions. The local Staff Judge Advocate (SJA) or the Legal Service Support Section-Civil Law should be consulted for advice on MWD legal questions.

6103. Interrogation. Per reference (e), MWDs will not take part of an interrogation approach or to harass, intimidate, threaten, or coerce a detainee for interrogation purposes.

6104. Posse Comitatus Act. Reference (p) prohibits concerted use, under orders, of units or individuals of the Army and Air Force to execute civilian law. Reference (s) applies this to the Navy and Marine Corps as a matter of policy. This law restricts the use of an MWD team in supporting civilian LE agencies; state and local. Further clarification is provided in section 6300 for this type of support.

6105. Military Working Dog (MWD) Team Qualification. Only MWD teams with current qualifications [see Chapter 5] can be employed in law enforcement operations.

6106. Use of Force. Reference (r) states that personnel engaged in law enforcement or security duties will use the minimum amount of force necessary to control the situation; therefore, MWD handlers must have a good working knowledge of the following policies relating to use of MWD force option:

1. Requirement. All patrol trained MWDs are considered a nonlethal weapon and subject to the use of force restrictions whether operating on or off-leash.

2. Force Options. Figure 6-2 shows the Force Continuum Model with the employment of MWD force as an option under Defensive Tactic [as defined in detail in reference (r)]. The handler must not release an MWD or allow it to bite until all other, less forceful means have failed or reasonably cannot be employed. Often, just the presence or arrival of an MWD team can control a situation.

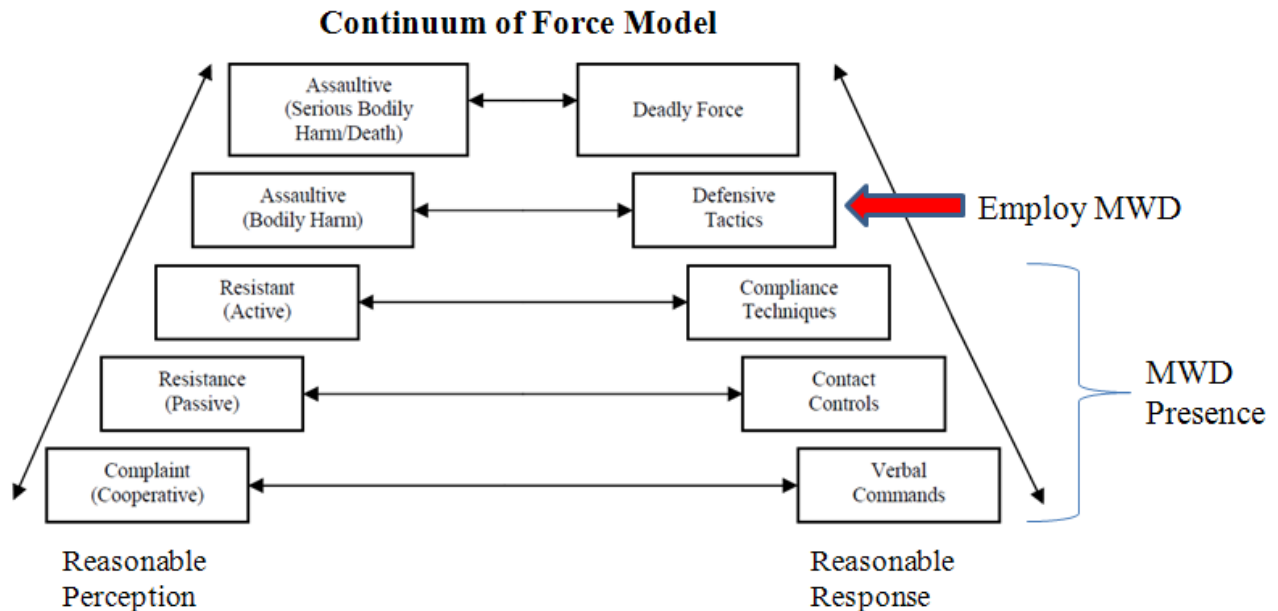

FIGURE 6-2.--Force Continuum Model with MWD Application

3. Control. The handler will maintain control of the MWD at all times. In most situations, the MWD team will not be able to get close enough to a suspect for the handler to effectively employ unarmed defense techniques such as irritant projectors or baton. If the minimum amount of force necessary to control the situation requires the use of an MWD, the handler must comply with the release policy of paragraph 6107.

6107. Policy on MWD Release. Instructions shall be included in local SOP to implement/enforce the following policy:

1. Release Restrictions. An MWD will not be released for a pursuit/bite under the following circumstances:

- a. If the MWD team does not have a current patrol validation.
- b. If no suspect is in sight.
- c. In the areas where children are present, except as a last resort short of using a firearm.
- d. Into a large crowd of people.

e. For crowd control or direct confrontation with demonstrators unless the responsible/on-scene commander determines it to be absolutely necessary. When it is necessary, the handler must take precautions to minimize the danger to innocent bystanders. Civil disturbance contingency plans should include specific criteria for the use of MWD teams.

f. In cases of minor offenses.

2. Before Release. The handler shall:

a. Be reasonably certain that the MWD has identified the same target as the handler.

b. Give a verbal warning order to halt or the handler will release the MWD.

c. Be reasonably certain that the suspect heard the warning and was given the opportunity to surrender.

d. Warn bystanders to cease all movement.

3. During Attack. The handler must:

a. Follow the MWD as closely as possible.

b. Call the MWD off the attack immediately if it is attacking someone other than the suspect.

c. Call the MWD off the attack as soon as the suspect stops/indicates surrender.

4. Recovery from Attack. The handler must:

a. Use extreme caution when removing an MWD from a suspect.

b. Regain and maintain leash control of the MWD until the MWD has become calm enough to obey the commands "HEEL" and "STAY".

c. Ensure anyone injured by an MWD receives timely medical treatment.

6108. Probable Cause Search

1. Requirement. The local SJA and reference (n) can provide advice and updated guidelines pertaining to proper search procedures and probable cause requirements.
2. Exempt MWD Searches. The following MWD searches generally do not require probable cause although some local SOPs may require additional consent authority for a final search [see table 6-3 for PASS form]:
  - a. Open Areas - fields, woodlands, border (for customs or immigration), roadways, bridges
  - b. Vehicles, Aircraft, Vessels [exteriors] - entering or departing a government installation.
  - c. Government Property - exterior and interior of work areas, common areas, public restrooms, hallways, etc. [not living quarters]
3. Key Factor. The key factor to determining the probable cause requirement is the compliance with the Fourth Amendment to the United States Constitution as described below.

<p>The <b>Fourth Amendment (Amendment IV)</b> to the United States Constitution is the part of the Bill of Rights which guards against unreasonable searches and seizures when the searched party has a "reasonable expectation of privacy". The amendment specifically also requires search and arrest warrants be judicially sanctioned and supported by probable cause.</p>
--

4. Establishing Probable Cause. The qualified MWD team [see paragraph 6105] is considered a "reliable informant".
5. Final Search Approval. Once the MWD makes an alert that is positively identified by the handler, the handler notifies the watch commander of the MWD response. Do not have a second MWD team confirm alert. The watch commander will follow local SOP to obtain approval from the search granting authority to proceed with the search and seizure of evidence.

**IMPORTANT:**

If significant incident details are not in writing, they may not be accepted as credible if presented verbally in later court testimony.

6109. Incident Reporting. Refer to reference (n) and local SOPs for additional details beyond the general guidelines provided below:

1. Use of MWD Force. The handler shall document MWD release and bites on an Incident Report (IR)[Form OPNAV 5580/1] and Statement of Force/Use of Detention (1630) [NAVMC 11130]. Report information should include, but not limited to the following:

- a. Suspect/subject state of mind at the time of incident.
- b. Severity of crime (refer to Use of Force order).
- c. Immediate threat, weapons (if applicable).
- d. Activity up to incident.
- e. Warnings given and suspect/subject position when warned.
- f. Opportunity for suspect/subject to surrender.
- g. True size of injury (dog bite).
- h. Include picture of injury after receiving medical care and before bandages are applied.

2. Illicit Substance Recovery/Seizure. The handler shall document circumstances involving recovery/seizure of illicit substances (drug/explosive) on the ICR per local SOP.

3. Videos. Handler should review any available videos of an incident (patrol car camera, security camera) prior to completing an ICR.

4. Written Policy Directive System (WDMS). Record finds as utilization.

6110. Legal Testimony

1. Introduction

a. MWD handlers, KMs, and trainers shall be available and prepared for testimony concerning their operations at non-judicial, judicial, or administrative proceedings.

b. MWD handler testimony may include the following:

(1) Search and seizure of illicit substances (drugs or explosives)

(2) Release of MWD

(3) MWD Bite

(4) Tracked suspects

c. In addition to the handler's recollection of the event as supported by the written reports [IR, NAVMC 11130, video], the MWD team qualifications may come into question.

2. Handler Preparation. The handler should prepare for any testimony by establishing a thorough understanding of the following topics:

a. Policy

(1) Chapter 5 and Appendix D provide the written documentation of the Marine Corps MWD team qualification requirements and evaluation guidelines.

(2) Chapter 6 documents the MWD employment instructions along with the policy for use of MWD force.

b. Training

(1) Appendix D provides guidance for the conduct of an on-going training program.

(2) Training is documented in WDMS and the signed monthly activity report is maintained in the MWD service record.

c. Past Performance. Past utilization is recorded in WDMS and the signed monthly activity reports are maintained in the MWD service record.

Section 6200 - Use of Military Working Dog (MWD) Capability

6201. Purpose. This section outlines and articulates the employment guidance that applies to MWD teams during the conduct of utilizing the MWD capabilities to patrol, detect or track.

**NOTE:**

Guidance provided in this section apply to all USMC MWD teams except where noted with a specific comment "LE Bn" which indicates some difference for those deployed teams from the LE Bn MWD section.

6202. Common to All Military Working Dog (MWD) Teams

1. Military Working Dog (MWD) Team Qualifications. The MWD team will only be utilized for canine related law enforcement or operational force support activities for which the team holds documentation of being current in all required team skill validations as defined in table 6-2.

<b>Table 6-2.- MWD Team Validation Required for Utilization Type</b>		
<b>WDMS Utilization Type (1)</b>	<b>MWD Type</b>	<b>Team Validation Required (2)(3)</b>
<b>Vehicle Patrol Walking Patrol Static Post</b>	Any	Basic Skills
<b>Controlled Aggression Intruder Detection Scout</b>	PDDD PEDD	Basic Skills Patrol
<b>Detection-Drug</b>	DDD PDDD	Basic Skills Drug Detection
<b>Detection-Explosive</b>	EDD PEDD SSD	Basic Skills Explosive Detection
<b>Track</b>	CTD	Basic Skills Tracking
<b>NOTES:</b>		
(1) Associated with team utilization activity recording in respective skill sections within the team data entry tab of WDMS.		
(2) See table 5-6 for details about validation prerequisite criteria.		
(3) <b>Drug and explosive teams must have an additional certification in accordance with section 5205 for probable cause searches.</b>		



24 FEB 2020

2. Control. The handler should have control over the MWD in the search area.
3. Other Duties. When the MWD is present, the handler performs the sole task of controlling and working his/her MWD and shall not take part in any other activities unless directed or authorized specifically by competent authority.
4. Deterrence. All Basic Skills validated MWD types can be utilized as a stand-off deterrent and presence, but only a patrol validated MWD team will be assigned to situations where actual release, bite or crowd control is probable (see paragraph 6106). The presence of any MWD team, regardless of capability, imposes a strong deterrent when used in LE operations since the public may assume the team is trained in drug/explosive detection.
5. Searching Individuals. For safety and liability purposes MWD teams should not be used to conduct searches of individuals; however, in limited situations MWD teams may be required to perform these tasks. All care must be taken to ensure there is no contact between MWD and individual being searched by providing a barrier for safety; e.g., a metal mesh fence.
6. Stray Animals. MWD handlers, dedicated MWD vehicles or any MWD assigned gear will not be committed to duties involving stray animals, nor will MWD facilities be used to house stray animals.

6203. Patrol. Patrol MWD teams (PDDD and PEDD) are used in law enforcement/policing operations in support of patrol tasks in table 6-1. The following procedures apply to specified patrol MWD team tasks:

1. Perimeter Security. To supplement existing security measures. When used randomly during higher threat conditions, patrol teams are an excellent tool to increase intruder detection and to enhance deterrence.
2. Public Confrontation. Should be used cautiously in confrontation situations, since their presence could escalate a situation. They should not be deployed on the front lines in riot control situations, but be standing by for use, if necessary. MWD handlers confronted in a housing area, club, etc., should use discretion in entering a building with an MWD.

LE Bn - refers to operation specific ROE policies before employing teams in crowd control situations, while adhering to the above recommendations.

3. Walking Patrol/Dismounted Patrol. A walking/dismounted patrol is defined as any foot mobile employment of an MWD team with the following guidance:

a. An MWD team used during daylight hours in congested areas provides a psychological deterrent. Most MWDs are tolerant of people, and the presence of a large number of people does not significantly reduce the MWD usefulness.

b. The MWD detection ability is more effective during darkness/limited visibility when there are fewer distractions. A person may flee a crime scene at night without being detected by patrolmen; however, a patrol MWD may detect a fleeing person and, if necessary, pursue, attack, and hold the individual.

c. A larger number of buildings and parking lots can be searched quicker for personnel suspects with a patrol MWD than by a single person.

d. Periodic use of MWD teams around on-base dependent schools, especially when school is starting and dismissing, may deter illicit activities from taking place.

e. Patrol MWD teams may be used to provide security for resources such as communications facilities, equipment, or command posts.

f. Patrol MWD teams may be utilized to secure on/off base disaster areas to include military aircraft crashes. Command SOP should address such situations.

g. LE Bn. The following should be considered when employing MWDs for the stated combat related functions:

(1) LE/Security/Presence Patrols. These are patrols to assist with maintaining the rule of law as the primary effect. MWDs used in this situation can provide active or passive deterrence for a range of potential situations.

(2) Census Patrols. These patrols are conducted to gather intelligence. MWDs can provide active or passive deterrence for potential situations.

(3) Contact Patrols. These are patrols where contact with enemy forces is expected to occur and safety of MWD teams should be considered.

(4) Cordon & Knock (C&K). A basic counterinsurgent tactic to cordon off an urban area and search the premises for weapons, illegal drugs and explosives and insurgents; all of which the MWD is well suited to locate. It is a technique used where there is no hard intelligence of targeted items in the house; therefore, is less intense than a normal house search. The purpose of the mission is to search a house with as little inconvenience to the resident family as possible so care should be given to MWD interaction with civilians. MWDs may also be used in a support role to assist with crowd control and apprehension of evaders from the search area.

4. Mobile/Mounted Patrol. A mobile/mounted patrol is defined as any vehicle employment of an MWD team with the following guidance:

a. Refer to section 10100 for vehicle safety precautions.

b. Mobile patrols are most effective when the MWD team uses the ride-awhile-walk-awhile method. The patrol is able to cover a larger patrol area and the exercise keeps the MWD alert.

c. LE Bn. Mounted patrols can be employed for sweeping choke points and high threat areas along the path of travel.

5. Building Checks. An MWD team is especially effective in checking and searching large buildings, due to their increased senses, areas can be covered in an expedient manner. For an MWD building search, have other MPs set up a cordon and provide a security element while the MWD team searches the area.

6. Vehicle Parking Lots. MWD presence may deter potential illicit activities.

7. Bachelor Enlisted Quarters/Bachelor Officer Quarters (BEO/BOQ). MWDs in BEQ/BOQ areas tend to decrease unlawful acts. MWD patrols should be used both day and night creating an effective psychological deterrent.

8. Alarm Responses. MWD team should respond to the activation of an alarm system. The MWD may be used to search and clear the building/area and assist in apprehensions.

9. Fund Escorts. During fund escorts, a patrol MWD provides both a psychological deterrent and active protection against potential robbery.

a. While escorting fund custodians to and from the vehicle, the MWD team should be slightly to the rear to observe hostile acts.

b. If the fund custodian is reluctant to ride in the same vehicle with the MWD, the MWD team should follow in another vehicle behind the fund custodian.

10. Traffic Operations

a. When a traffic stop is made, the MWD may accompany the handler per local SOP.

b. MWD teams should not be used for routine traffic control or accident investigation duties.

11. Apprehension of Individuals

a. When approaching to check identification or make an apprehension, the handler must warn the individual that the MWD is trained to attack, with or without command, and the suspect should not make any sudden or aggressive movements.

b. Have a second MP/police officer present, if available, so the other officer can conduct the search while the MWD team provides the over-watch.

c. Use the MWD as backup if no other units are available.

d. If possible, a back-up patrol unit should be used to transport personnel in custody.

e. If the handler must transport the suspect, the MWD should be positioned in the following ways:

(1) In the back seat and the suspect in the front passenger seat, or

(2) In rear in kennel and the suspect in rear seat.

6204. Drug/Explosive Detection. The following procedures apply for searches conducted in support of tasks in table 6-1:

1. Restrictions. The MWD team's sole function is to indicate by giving a trained final response on the location of suspected illegal drug/explosive. The handler will not provide the following services:

- a. Legal advice.
- b. Validate the response of another detector dog or detective device, mechanical or electronic.

c. Explosive

(1) Handling or taking custody of any explosive device(s) they may discover. When any explosive trained MWD responds, Explosive Ordnance Disposal (EOD) personnel or the on-scene commander will provide further instructions as to the handler's actions.

(2) Search/scan suspicious packages; however, the MWD can and should be used to clear the surrounding area for possible secondary devices which will provide the first responders with a secure perimeter.

2. Search Requests. The legal considerations as described in section 6100 for search requirements must guide the use of an MWD team to detect illicit drugs/explosives. The type of search is recorded as a support category when recording utilization activities in WDMS.

Table 6-3.--Search Requests					
Request (1)	Type Detection	Support Category	Sub-Support Category	Search Description	Authorized By
Bomb Threat (3)	Explosive	<ul style="list-style-type: none"> <li>• Base Operations</li> <li>• City Agency</li> <li>• U.S. Customs and Border Protection</li> <li>• County Agency</li> <li>• Deployment/ Combat Ops</li> <li>• Drug Enforcement Agency</li> <li>• Department of Homeland Security</li> </ul>	Other (only if Base Operations); all others do not apply	Emergency response to verbal or written threat of <u>hidden</u> explosive device. <ul style="list-style-type: none"> <li>• Building</li> <li>• Public Area</li> <li>• As directed</li> </ul>	<ul style="list-style-type: none"> <li>• Installation Commander for off-base responses</li> <li>• Installation Commander Emergency Response SOP</li> </ul>

**Table 6-3.--Search Requests**

Request (1)	Type Detection	Support Category	Sub-Support Category	Search Description	Authorized By
		<ul style="list-style-type: none"> <li>• Department of State</li> <li>• Off Base - HMX-1 Assignment</li> <li>• Off Base - Other</li> <li>• State Agency</li> <li>• TSA</li> <li>• U.S. Maritime Service</li> <li>• U.S. Secret Service</li> </ul>			
<ul style="list-style-type: none"> <li>➤ Command Authorized Request (CAR) (2)</li> <li>➤ Command Authorized Inspection</li> <li>➤ Health and Comfort</li> </ul>	<ul style="list-style-type: none"> <li>• Drug</li> <li>• Explosive</li> </ul>	Base Operations	Cmd Authorized Request	Unannounced, scheduled search of- <ul style="list-style-type: none"> <li>• Barracks</li> <li>• School</li> <li>• Living quarters</li> <li>• Buildings</li> <li>• Aircraft</li> <li>• Vehicles on base (see COVI)</li> </ul>	Installation Commander or Commanding Officer of tenant unit
Command Authorized Search & Seizure (CASS)	<ul style="list-style-type: none"> <li>• Drug</li> <li>• Explosive</li> </ul>	Base Operations	Cmd Authorized Request	<ul style="list-style-type: none"> <li>• Used when MP has probable cause from MWD alert, but person does not authorize detailed search.</li> <li>• Person detained until CASS document received.</li> </ul>	Installation Commander <u>or</u> Commanding Officer of tenant unit
<ul style="list-style-type: none"> <li>➤ Command Authorized Vehicle Inspection (CAVI)</li> <li>➤ Command Authorized Random Vehicle Inspection (CARVI)</li> </ul>	<ul style="list-style-type: none"> <li>• Drug</li> <li>• Explosive</li> </ul>	Base Operations	CO Vehicle Inspection	<ul style="list-style-type: none"> <li>• Unannounced search of vehicles</li> <li>• Date, location and random selection criteria defined in advance by installation commander.</li> <li>• Includes vehicle documentation check</li> </ul>	Installation Commander

**Table 6-3.--Search Requests**

<b>Request (1)</b>	<b>Type Detection</b>	<b>Support Category</b>	<b>Sub-Support Category</b>	<b>Search Description</b>	<b>Authorized By</b>
Commanding Officer Vehicle Inspection (COVI) (2)	<ul style="list-style-type: none"> <li>• Drug</li> <li>• Explosive</li> </ul>	Base Operations	CO Vehicle Inspection	<ul style="list-style-type: none"> <li>• Specific vehicle - any type [POV, bus, truck]</li> <li>• Possibility of uncovering evidence that can be used in a court-marshal</li> </ul>	Commanding Officer of tenant unit on installation
Commercial Vehicle Inspection (CVI)	<ul style="list-style-type: none"> <li>• Drug</li> <li>• Explosive</li> </ul>	Base Operations	CO Vehicle Inspection	<ul style="list-style-type: none"> <li>• Scheduled in lot for commercial vehicles</li> <li>• Exterior search</li> </ul>	Installation Commander
Mission Essential Vulnerable Area (MEVA) (2)	Explosive	Base Operations	Mission Essential Vulnerable Area	Defined installation areas for searches conducted on set schedule. <ul style="list-style-type: none"> <li>• Fuel Depot</li> <li>• Flight Line</li> <li>• Treatment Plant</li> <li>• ASP</li> <li>• As directed</li> </ul>	Installation Commander
Permissive Authorization of search and seizure (PASS)	<ul style="list-style-type: none"> <li>• Drug</li> <li>• Explosive</li> </ul>	Base Operations	Other	Property owner signs document (PASS) to authorize search of the interior of property	Property Owner
<ul style="list-style-type: none"> <li>➤ Random Anti-Terrorism Measure (RAM) (2)</li> <li>➤ Anti-Terrorism Force Protection (ATFP)</li> </ul>	Explosive	Base Operations	Random Anti-Terror Measures	Random scheduled search of critical area. <ul style="list-style-type: none"> <li>• Vehicles at gate</li> <li>• Day care center</li> <li>• Stadium</li> <li>• Hangar</li> <li>• As directed</li> </ul>	Installation Commander
VIP Sweep (2)	Explosive	Base Operations	VIP Sweep	Search of any installation areas in advance of VIPs arrival. <ul style="list-style-type: none"> <li>• General's Quarters</li> <li>• Auditorium</li> <li>• Buildings</li> <li>• As directed</li> </ul>	Installation Commander

**NOTES:**

(1) Some requests are referred to by multiple terms within the Marine Corps law enforcement community.

Table 6-3.--Search Requests					
Request (1)	Type Detection	Support Category	Sub-Support Category	Search Description	Authorized By
(2)				Selection in WDMS support category listing. <u>All other</u> base requests would be classified as "Base Ops-Other".	
(3)				Bomb threat is separate field entry in the WDMS detection utilization data entry screen.	

a. Searches will be conducted at the direction of the requesting authority, normally the installation commander, or the tenant unit commanding officer. All functions concerning the search, e.g., coordination, personnel assignment, duration, shall be the responsibility of the requesting authority or the PM/PC.

b. The KM will cancel/reschedule a search due to the non-availability of MWD teams; e.g., MWD health reasons as approved by the PM/PC. The requesting command will be notified as far in advance as possible.

c. The KM can terminate any search for reasons; i.e., hazardous situations, or noncompliance with established procedures.

3. Publicity. Publicity about the general presence and effective use of MWDs may reduce illegal drug use/trafficking and the introduction of explosives.

4. Team Assistance. It is recommended to have another handler act as a spotter and carry extra gear, if available. In large searches, have another MWD team assist, if available.

5. MWD Alert. At the time of alert, the handler must be ready to provide the following MWD reliability information:

a. An MWD handler conducting probable cause searches should be prepared to verbally provide the following information to the search granting authority.

- (1) Certification end date
- (2) Odors that MWD is qualified to detect
- (3) Specifics on the MWD response



b. LE Bn. The handler shall be aware of the above information (except use Validation End Date for (1)) at the time of alert.

6. Search Area Precautions. The handler is to ensure the following is accomplished during an MWD search, when operationally possible:

a. Proceed to the search area after being given clearance by the on-scene commander.

b. Nonessential Personnel. For safety purposes, only those individuals trained to assist an MWD team should be permitted to actively participate in search operations.

c. Communication Equipment. Local SOP will dictate the use of communication equipment (cell phones, tactical radios, etc.) during the conduct of an explosive search.

d. Spotters shall advise the MWD team of toxic/volatile substances, paints, metal/wood shavings, broken glass, oil/grease spills, powdered substances, unsecured foods and other items which might distract or be harmful to the MWD team. The MWD handler may refuse to search any space not considered safe due to hazardous materials.

e. No one should be allowed to remove suitcases, sea bags, parcels or any other items.

f. Personnel who must dress to leave the area should be observed to prevent the removal of small parcels/contraband.

g. Conduct the following bomb threat responses:

(1) Mark the area of alert and collect as much information as possible in order to provide the on-scene commander and/or EOD a description/diagram of the area.

(2) Establish perimeter as quickly and safely as possible, while simultaneously searching for secondary devices.

(3) Brief responding EOD personnel on the item location and method of marking.

(4) Resume the search for secondary explosive devices after EOD declares the device safe.

7. Search Area Considerations. In addition to the detection precautions provided above, the following area specific considerations apply:

a. Aircraft. MWD teams should be familiarized with the unique searching environment an aircraft creates prior to accepting this type of search. The recommended search procedure for a grounded aircraft is exterior followed by the interior.

b. Buildings/Warehouses. These areas present unusual problems because of wind circulation, distractions, and inaccessibility to all productive areas. Large areas should be broken down into several smaller areas. The handler should always approach buildings from the downwind side [when practical] to maximize the MWD senses.

c. Shipboard. MWD teams can be used aboard vessels for drug/explosive detection. MWD teams should be familiarized with the unique searching environment a ship creates prior to accepting this type of search.

d. Vehicles

(1) Most vehicle searches are conducted in an open area environment allowing the handler to use the prevailing wind when approaching the vehicle.

(2) Ensure the vehicle is turned off and all occupants exit and remain away from the vehicle while leaving doors and trunk open.

(3) Ensure MWD searches exterior area to include door seams, undercarriage, engine compartment and trunk. Caution should be used around hot exhaust pipes and engine compartments.

(4) Do not allow the MWD to enter the vehicle unless the MWD makes a change of behavior outside and further inspection is necessary.

(5) Do not allow the MWD to jump through an open window.

6205. Tracking. CTD teams can support tracking tasks of table 6-1 in the operating environment, aboard installations and to off-base to civilian LEAs. The following are employment considerations:

1. Reengaging a foot-mobile suspect. Depending on the nature of the committed crime it may be necessary to provide security personnel for the CTD team since attention will be divided

between the MWD and surrounding area. Tracking criminal suspects is restricted to operational and installation duties. Where probable cause comes into question, CTD teams must have all required validations per Chapter 5.

2. Finding a lost/missing person. Given a general area, the CTD can potentially locate the trail of the individual and lead LE personnel to the source. CTD teams must have all required validations per Chapter 5 [except for life-saving tracks where a new MWD team has yet to complete all qualifications events].

3. Consult with SJA to determine if additional considerations apply for an off-base track.

4. Law Enforcement Battalion (LE Bn)

a. Track from an IED or cache to provide direction of travel and potential location to an IED planter or cache maker. Where probable cause comes into question for tracking a criminal suspect who may be brought before a host nation court, the CTD team shall be current in all required validations.

b. Track retreating personnel to reengage with enemy forces.

c. Track known human scents to reestablish contact with lost friendly forces.

Section 6300 - Non-Operational Support to Federal and  
Civilian Law Enforcement Agencies (LEA)

6301. Purpose. This section outlines and articulates the policy and procedures as they apply to MWD team non-operational support to federal and civilian law enforcement agencies (LEA).

6302. Policy

1. Approval. If installation operational commitments allow, Marine Corps MWD teams can provide support, with command approval and not otherwise specifically restricted by HQMC, to Federal and civilian LEAs to include state and local agencies.
2. Tasking. Assignments will be tasked to the installation MWD sections through their chain-of-command. The LE Bn MWD section will only be requested to provide support in unusual circumstances.
3. Compliance. The MWD teams tasked to provide support will comply with the MWD use guidelines previously covered in this chapter, along with applicable regulations that are addressed below and provided in the tasking support message.

**IMPORTANT**

An MWD will not be dispatched to support other LEAs without a qualified handler who will work directly with the MWD.

4. Support Restrictions. To be in compliance with references (s) and (t), the following handler restrictions will apply when assigned to this type of duty:

- a. The only off-base assistance role is to operate an MWD for the purpose of detecting a target odor.
- b. An MWD team does not have authority to conduct any law enforcement functions or use the MWD in any other purpose other than prescribed within this section.
- c. A CTD team may be used off-base only for tracking to prevent loss-of-life for a lost person -- Not criminal suspects. Local SJA may require advance approval.

d. Will not engage in the execution of a warrant/arrest, or take part in any other law enforcement duties.

e. Will not take possession of or dispose of any explosive ordnance.

f. Will not help in uncovering or moving any item that has been identified to have potential value as evidence.

g. Will not take possession of any illicit drug substances or contraband.

h. Will not set up or maintain a chain-of-custody for any evidence or other material planned for use in civilian courts.

i. Will not allow MWD to be used to seize, track, attack or hold a suspect/subject.

j. Will not take custody of a suspect/subject.

6303. State and Local Support

**IMPORTANT**

[**Counter-Drug Support**] reference (t):  
Message states the immediate suspension of the use of any drug detection MWD support to civilian authorities where support requested is to engage in the execution of a warrant, search, seizure, arrest, or any other activity to enforce the law in connection to this support. Direct all questions to the local SJA.

1. Approval Process

a. Normally, direct requests come from local civilian LEA to an installation where MWD teams are assigned.

b. The installation commander can approve state/local LEA requests and provide support per reference (s).

c. The installation commander's approval authority is only for the installation PMO MWD assets.

d. Use of LE Bn MWD teams is coordinated through the parent MEF commander.

24 FEB 2020

2. Memorandum of Understanding (MOU). Installation commanders should have a memorandum of understandings (MOU) approved by the SJA for contingency off-base MWD support planning where applicable.

3. Team Qualification. An MWD team, both military and civilian police, shall have a readiness category of **Ready, or Restricted 1 thru 4**, (in WDMS) at the time of departure for the off-base MWD assignment.

4. MWD Team Procedures. The following apply for off-base State and local LEA support activities unless otherwise addressed in a local SOP:

a. Credentials. Handlers are authorized to wear the military MP badge. MWD section personnel should have the issued MP identification in a wallet type case for quick inspection by the requesting agency. Regardless whether or not the MP identification is issued, a current Government picture identification card shall be available at all times.

b. Uniform/Equipment. Handlers are authorized to wear the Marine Pattern (MARPAT) uniform [or the issued work uniform for civilian handlers w/o Velcro badge] and issued protective equipment (helmet, vest, etc.) along with MWD support items as required.

c. Weapons. Handlers are authorized to carry an issued sidearm.

d. Conduct of the Search

(1) A representative of the requesting agency must be present at all times when working the MWD.

(2) The MWD can be used on or off-leash depending on the type of detection work and the proximity to uninvolved personnel.

(3) If the MWD responds, the handler will advise the agency representative and withdraw. The team may then continue searching in another disassociated area.

(4) Support restrictions of paragraph 6302.4 apply.

e. Emergency Situations. In the case that an unpredictable violent situation does arise, the handler is authorized to use

the minimum level of force appropriate to protect the handler and/or the MWD.

5. Court Action. The handler may testify in civil court. See paragraph 6109 for information that may be required.

6. Expenses. The requesting agency is responsible for all costs associated with the assignment unless approved otherwise by the installation commander or other designated personnel.

7. Reporting. All support activity to civilian agencies is to be recorded in WDMS and identified under the appropriate type of utilization support category. Incidents involving injury by or to the MWD team must be reported to the MWD PM [see Appendix C].

#### 6304. Federal Support

**Note:** MC MWD-7, USMC MWD Program Handbook for Non-Operational Federal Missions, contains helpful information and activity log sheets for MWD teams on federal non-operational missions.

##### 1. Request Process

a. As the DoD MWD Executive Agent, the USAF serves as the primary focal point for processing non-operational mission requests, not covered in paragraph 6303, through the MWD Scheduling Cell located at JBSA-Lackland.

b. Per reference (n), the Marine Corps MWD Program is part of the overall DoD MWD population and receives requests from the MWD Scheduling Cell to provide MWD team assets on a geographical basis to support non-operational missions.

c. This requirement is tracked in WDMS and further distributed by MWD PM to MWD teams according to geographic location via the request chain-of-command identified in figure 2-2.

2. Mission Process. Table 6-4 provides a sequential overview of the steps taken from mission request through execution.

Table 6-4.--Process for Non-Operational Missions		
Step	Action	Action by
1	Receives requests from federal agencies for drug/explosive detection support.	MWD Scheduling Cell

<b>Table 6-4.--Process for Non-Operational Missions</b>		
<b>Step</b>	<b>Action</b>	<b>Action by</b>
<b>2</b>	Validate request and identify if USMC assets are in proximity to mission location in order to minimize cost.	MWD Scheduling Cell
<b>3</b>	Notify MWD PM POC and provide official mission request message w/following: <ul style="list-style-type: none"> <li>• Mission Type &amp; Identification</li> <li>• Location</li> <li>• Timeframe</li> <li>• POC name and contact number(s)</li> <li>• Type/number of MWD teams required</li> <li>• Special instructions or requirements</li> </ul> <b>NOTE: Expedited requests for short-notice support will be conducted via phone. Written mission requests will be forwarded as soon as possible.</b>	MWD Scheduling Cell
<b>4</b>	Forward official request message via chain-of-command [see figure 2-2] based on closest installation to mission location.	MWD PM POC
<b>5</b>	Load mission information into WDMS mission management feature.	MWD PM POC
<b>6</b>	Chain-of-command establishes supportability response back to the MWD PM POC via email or phone. Response should be within (4) hours of initial notification unless otherwise annotated in the mission support request. Supporting unit(s) will be identified in the response if applicable.	Command
<b>7</b>	<ul style="list-style-type: none"> <li>• Depending on the scope of the mission, coordination with more than one command may be required.</li> <li>• Notify MWD Scheduling Cell what support, if any, can be provided.</li> <li>• If mission cannot be supported, identify rejecting commands in WDMS and cancel mission.</li> </ul>	MWD PM POC
<b>8</b>	Identify assigned mission MWD teams and supervisor (if applicable) in the WDMS mission management feature.	KM
<b>9</b>	Provide the MWD PM POC the supporting team information.	KM
<b>10</b>	Complete the on-line Handler Information Sheet as directed in the mission support message.	KM
<b>11</b>	Releases the official mission tasking message to the MWD PM POC.	MWD Scheduling Cell
<b>12</b>	Forward official mission tasking message to the supporting unit with info copy to command representatives.	MWD PM POC



<b>Table 6-4.--Process for Non-Operational Missions</b>		
<b>Step</b>	<b>Action</b>	<b>Action by</b>
<b>13</b>	<ul style="list-style-type: none"> <li>• Ensure the assigned MWD handler(s) and supervisor receives a copy of the mission tasking message because it provides critical information pertaining to the mission.</li> <li>• Contact the supported agency (USSS, DOS, or etc.) POC for further instructions if required [billeting, transportation, etc.].</li> <li>• If there are plan changes or delays in route, contact the MWD PM for further guidance. An alternate is to contact the MWD Scheduling Cell [see Appendix C].</li> </ul>	Supporting Unit
<b>14</b>	<ul style="list-style-type: none"> <li>• Complete trip preparations to include MWD medical documentation [see paragraph 8203 for travel requirements].</li> <li>• Report to the mission location, perform mission, and return to their installation upon completion.</li> </ul>	MWD Team / Supervisor
<b>15</b>	Complete and submit travel claim per the instructions provided in the tasking message.	Handler / Supervisor
<b>16</b>	Load cost information into the WDMS mission management feature.	Handler / Supervisor
<b>17</b>	Review and approve mission related costs recorded in the WDMS mission management feature.	KM
<b>18</b>	Review all KM approved mission cost information and finalize task which will close the mission in WDMS.	MWD PM POC

3. Operational Control. The requesting agency POC will have operational control over assigned MWD teams and supervisor (when provided) during the duration of the mission.

4. Mission Team Requirements

a. Qualification. An MWD team, both military and civilian police, shall have a readiness category of Ready, or Restricted 1 through 3, (in WDMS) at the time of departure for the mission.

b. Government Travel Credit Card (GTCC). All MWD personnel must have active GTCCs to go on non-operational missions. KMs must ensure mission team members are aware of the restricted use of the GTCC, procedures for signing for and obtaining vendor invoices, and the consequences of any unauthorized use. See table 3-3 about obtaining a GTCC.

24 FEB 2020

c. Passport. For OCONUS missions, each handler/supervisor shall have a current "Official-No Fee" passport. See table 3-3 about obtaining a passport.

d. MWD Medical. Refer to paragraph 8203 for documentation required for MWD travel via interstate or on commercial airline.

e. Standard of Conduct. Handlers and supervisors must be aware that due to the high-visibility, location and nature of a non-operational mission; the requesting agency/command may impose enhanced standards of personal conduct during the duration of the mission assignment. These standards may include, but not limited to, alcohol consumption, liberty restrictions, and interaction with foreign nationals. All Marine Corps military and civilian MWD personnel are expected to comply with enhanced conduct standards that are presented by the requesting agency POC and with the procedures for lodging an MWD in commercial lodging per paragraph 10009.

#### 5. Mission Team Composition/Duties

a. A mission supervisor may be specified by the requesting agency.

b. Spotters and other support personnel will not be used without the approval of the MWD Scheduling Cell, after coordination with the requesting agency.

c. The senior ranking MWD handler, regardless of service affiliation, is designated as the supervisor.

d. The supervisor shall do the following:

(1) Report directly to the requesting agency POC and serve as the MWD representative during all on scene mission meetings conducted by the requesting agency.

(2) Assist in planning search schedules.

(3) Coordinate issue/return and accounting of any special identification or equipment provided by the requesting agency for use by the mission team members.

(4) Resolve problems during the mission involving MWD personnel.

(5) Prepare a mission after-action report (AAR) when extenuating circumstances develop during the mission [explain Who/What/Where/When/Why & How in report format specified in the tasking instructions] (see paragraph 6304.12).

(6) Ensure handlers have positive control of MWD and that MWDs receive proper care and security.

(7) Perform other duties as required/directed.

## 6. Communication

a. The MWD Scheduling Cell will provide 24-hour contact information to the mission members for assistance when required.

b. Equipment. Equipment and items such as credentials may be issued to mission team members. It is the handler's responsibility to ensure adequate protection is afforded the equipment. All equipment must be returned to the agency POC prior to departing the mission location. Handlers need to request satellite phones from the requesting agency for OCONUS assignments.

7. Mission Types/Funding/Travel Claims. Table 6-5 provides a summary of the most common type of missions by requesting agencies along with a general funding guide.

a. The MWD Scheduling Cell will provide fiscal data and detailed reimbursement instructions to the respective supporting command for reimbursable missions.

b. In accordance with reference (ap), handlers/supervisors supporting POTUS and VPOTUS missions are required to pay for all hotel expenses and file for reimbursement on their travel claim. Refer to reference (u) for guidance on completing mission travel claims.

c. Handlers/supervisors on missions are not required to accept meals and/or meals ready to eat (MREs) in lieu of per diem purchases.

d. KMs must ensure civilian handlers/supervisors understand and agree to compensation arrangements necessary for possible overtime outside of normal union working hours.

24 FEB 2020

<b>Table 6-5.--Non-Operational Mission Types/Funding</b>			
<b>Requesting Agency</b>	<b>Type Detection</b>	<b>Support Description</b>	<b>Funding</b>
United States Secret Service (USSS)	Explosive	<ul style="list-style-type: none"> <li>• President U.S.(POTUS)</li> <li>• Vice President U.S.(VPOTUS)</li> </ul>	<ul style="list-style-type: none"> <li>• All costs are the responsibility of the supporting MWD team command.</li> <li>• Funding <u>may</u> be provided by MWD PM on a case-by-case basis.</li> <li>• Team member pays for all hotel expenses.</li> </ul>
		<ul style="list-style-type: none"> <li>• Officer in order of succession to the president</li> <li>• First Lady U.S. (FLOTUS)</li> <li>• Former POTUS (FPOTUS)</li> <li>• Other dignitaries</li> </ul>	<ul style="list-style-type: none"> <li>• Fully reimbursable funding provided by the MWD Scheduling Cell utilizing USSS funds.</li> <li>• MWD Scheduling Cell will provide Line of Accounting (LOA) for use on travel orders.</li> </ul>
Department of State (DoS)	Explosive	<ul style="list-style-type: none"> <li>• Secretary of State (SoS)</li> <li>• Foreign dignitaries</li> </ul>	<ul style="list-style-type: none"> <li>• Fully reimbursable funding provided by the MWD Scheduling Cell utilizing DoS funds.</li> <li>• MWD Scheduling Cell will provide LOA for use on travel orders.</li> </ul>
National Special Security Events (NSSE)	Explosive	<ul style="list-style-type: none"> <li>• Presidential Election Events</li> <li>• High level national events</li> </ul>	<ul style="list-style-type: none"> <li>• Funding is based on a case by case determination by the Secretary of Defense.</li> </ul>
Other Agencies <ul style="list-style-type: none"> <li>• United States Coast Guard (USCG)</li> <li>• Homeland Security (HLS)</li> </ul>	Drug Explosive	As defined in the request message	The requesting agency will provide a funding line of accounting prior to the mission.

## 8. Clothing/Equipment

a. The mission tasking message normally specifies the appropriate uniform while on duty. See paragraph 3202 for

24 FEB 2020

information about clothing allowance and Appendix Q for clothing examples.

b. Firearms are not authorized.

c. Protective equipment (helmet, vest, etc.), if required, will be identified in the mission request and normally be unit issued to the team member and taken to the mission site.

d. MWD Training Aids

(1) MWD handlers must coordinate with the requesting agency POC to ensure drop aid requirements are known prior to the mission. Handlers must also receive permission to bring their own drop aids. Restrictions for on-site drug storage and air transport of explosive aids may prevent handlers from bringing their own drop aids. Use of sealed drop aids containing only the scent may help circumvent these restrictions [see paragraphs 11409 and 12309 about drop aids].

(2) The requesting agency POC is responsible for ensuring an adequate amount of training and reinforcement aids are made available throughout the mission.

e. Checklist. Prepare and utilize a checklist of key items necessary to accompany the MWD team on mission to include the following:

(1) Equipment identified in this section.

(2) MWD care items.

(3) Required MWD transportation documentation [see paragraph 8203].

(4) Copy of relevant health record documents as provided by the VCO [see section 10200].

## 9. Credentials

a. Supervisors/handlers will not wear the military MP badge. MWD section personnel should have the issued MP identification in a wallet type case for quick inspection by the requesting agency. Regardless whether or not the MP identification is issued, a copy of travel orders and a current Government picture identification card shall be available at all times.

b. The requesting agency may provide mission team members with an identification badge/pin that will be worn and presented per the instructions provided by the agency POC. Normally, issued identification items are returned to the agency POC prior to departing the mission.

10. Veterinary Care

a. Veterinary care will normally be coordinated by the requesting agency POC.

b. Contact should be made with the nearest military veterinarian or local law enforcement K-9 unit if adequate veterinary care is not available.

11. Transportation. These procedures apply when planning transportation requirements for the MWD team:

a. Aircraft. See paragraph 8203 for procedures applicable to MWD shipping.

b. Vehicles

(1) Reserve rental vehicles prior to the initiation of a mission.

(2) Consult the agency POC to see if the requesting agency has reserved vehicles at the mission location.

(3) Ensure all vehicle accidents are reported immediately to the requesting agency POC, the MWD Scheduling Cell and the handler's chain-of-command.

(4) Complete and return all appropriate paperwork completed and returned to the rental vehicle company prior to departing the mission location.

(5) Unmarked government vehicles may be used with prior approval of the requesting agency or as instructed in the official tasking message.

(6) Vehicles used to transport MWD on non-operational missions must be equipped with air conditioning.

(7) Handler shall comply with safety precautions in section 10100 that apply to MWDs in vehicles.

12. Reporting

a. MWD Damage. Damage caused by an MWD must be reported immediately to the requesting agency POC, the MWD Scheduling Cell and the handler's chain-of-command.

b. After-Action Report (AARs)

(1) If directed in tasking instructions or if a situation occurs during the mission requiring attention, explain Who/What/Where/When/Why & How in requested report format.

(2) Should be submitted within five calendar days of end of mission unless otherwise specified.

(3) The supervisor shall send (via email, fax, mail) a completed report to the MWD Scheduling Cell who will forward a copy to the MWD PM POC [see Appendix C].

(4) Typed reports are preferred, but hand written is acceptable if necessary to expedite the process.

c. Mission Issues

(1) Supervisor/handler shall submit mission AAR for the following situations:

(a) Incident having possible consequences.

(b) Confusion or disagreements arise with requesting agency.

(c) Suggested improvements to procedures.

(2) If an issue does arise, the mission supervisor/senior handler shall meet privately with the requesting agency POC and attempt to find a solution.

(3) If a problem cannot be resolved, MWD personnel shall respond as directed by agency POC, unless directions would compromise the safety of the MWD team.

(4) The MWD Scheduling Cell will take follow-up action as required to resolve such incidents and prevent any future recurrence.

24 FEB 2020

(5) If warranted, the MWD Scheduling Cell will provide an informational copy of the report to the involved agency.

d. Working Dog Management System (WDMS). Utilization and training activities conducted on missions will be recorded in WDMS.



Chapter 7

Military Working Dog (MWD) Team Development And Disposition

Section 7000 - MWD Team Determination

7001. Purpose. This section provides an overview of the procedures and policies associated with the initial planning for the development of MWD teams to be formed within a Marine Corps command.

7002. Initial Planning

1. Introduction. This section contains information that is useful in planning an MWD Program or adding MWD teams to an existing program. The guidelines in this section are not meant to be absolutes for utilization, training, or maintenance, but intended to provide general guidance for the planning process. The decision process, in conjunction with input from senior members of the MWD community, requires an accurate evaluation of the requirements for each MP and MAGTF mission.

2. Consideration Factors. The following consideration factors are provided by MP organization:

a. Installation/Bases PMO/MCPD

(1) Capability to schedule coverage of a watch/shift for patrol, drug and explosive detector capabilities. Unless specifically requested otherwise, MWDs will be dual qualified with either patrol drug or patrol explosive capabilities. The most common shift is eight hours with three shifts per day. At a minimum, one MWD team of each type (drug/explosive) should be on-call at all times.

(2) The number of MWD teams by MWD types authorized for an installation is based on USMC bases being designated as a small, medium or large base by HQMC (PS) which takes into account the following:

- (a) Number of walking and vehicle patrols.
- (b) The size of the area of responsibility.
- (c) The population of the area of responsibility.
- (d) The number of personnel to be served.

(e) The types of terrain.

(f) The number of critical facilities or areas.

(3) The MWD section structure guideline is as follows:

(a) One KM per section.

(b) One trainer per section.

(c) One handler assigned per MWD.

(4) The projected capability to provide logistics support and patrol vehicles per table 9-4 has been a major factor that negates the effectiveness of MWD teams.

(5) Installation planning should not include support to operating force deployments since this task as a general rule will be supported by the LE Bn MWD sections.

b. Operating Force (LE Bn)

(1) The types and projected number of combat support missions for which each MWD team capability can be used.

(2) Ability to maintain favorable rotation periods for personnel and MWDs. The standard consideration is that handlers are back at the home base [lag period] as long as they are on deployment. The lag period for an MWD should be at a minimum of 90 calendar days to allow for acclimation and the team qualification process.

(3) The projected MWD team support allocation throughout the MEF. All LE Bn MWD sections have identical Tables of Organization (T/O) and consist ideally of three squads of identical MWD team capabilities.

(4) LE Bn planning should not include support to non-operational missions since, as a general rule, this task is to be supported by the installation MWD sections.

7003. Validation of Existing Authorization. Per reference (n), the validation process is to be used to validate military police requirements including MWD authorizations. The following criteria should be utilized in this process:

1. Team Activities. MWD team activities break down into two categories: Qualification and Utilization.

a. Qualification consists of Training, Validation, and Certification (TVC) activities as defined in Chapter 5.

b. Utilization consists of the employment activities of qualified teams as defined in Chapter 6.

c. Utilization is the primary focus for all MWD teams. Training is the primary focus for Operating Forces when not deployed.

2. Adjustment. Adjustments must be made based on actual use data as can be provided from the WDMS team activity records which clearly define the time committed to utilization and TVC. The annual command chronology report is also a valuable source of activity data.

3. Baseline Considerations. As a baseline review consideration at an installation MWD section -

a. The MWD team utilization levels, as recorded in WDMS, validate the MWD Table of Equipment authorization by meeting the activity requirements stated in paragraph 8104.1.d.

b. Qualification hours should not be elevated merely as a substitute for lack of utilization.

Section 7100 - Military Working Dog (MWD) Organization  
Adjustments

7101. Purpose. This section provides an overview of the procedures and policies associated with making adjustments to the Marine Corps MWD organization.

7102. Introduction. Constructing or changing an MWD team capability, either military or civilian police, is a process which impacts the T/O, for the handler, and T/E, for the MWD. After the initial planning phase, transactions are initiated to acquire both team components for a desired capability. This section will provide the instructions necessary to utilize the two key established Marine Corps management systems; the Total Force Structure Management System (TFSMS) and WDMS, in order to accomplish the tasks of acquiring MWD team assets.

7103. Personnel Change

1. Submission. The MWD sections T/O is managed in TFSMS. Change requests are initiated by the owning command with electronic submission of a Table of Organization and Equipment Change Request (TOECR) per reference (v).

2. Table of Organization and Equipment Change Request (TOECR) Process. The TOECR is used to change any element of the MWD section structure, either military or civilian, to include addition/deletion of the Billet Identification Code (BIC) line, rank, billet description or MOS. Requests must include justification for the personnel change to include the associated impact to the MWD capability requirement as in the case of an increase/decrease in handlers. The TOECR approval process begins with unit leadership and moves through the chain-of-command; MWD specific ones are reviewed by the MWD PM. Updates to the force structure are normally conducted twice per year with changes incorporating the approved TOECRs since the last update. Once in the force structure, necessary manpower adjustments will be initiated by HQMC.

3. Force Structure Update. The MWD section structure in WDMS is updated by MWD PM after each force structure update is available in TFSMS. See Appendix C about communicating with the MWD PM about force structure updates in WDMS.

4. Personnel Restructure. Changes that are the result of handler authorization will be defined in the TOECR process [see paragraph 7103.2] and, once approved, will be implemented by the

MWD PM. MWD authorizations are managed by the MWD PM. Changes resulting from an approved TOECR will be noted in WDMS with revisions to the billet structure and MWD authorizations. If the authorization increases, the MWD PM will create an initial order in WDMS which will be shown in the MWD section status dashboard. Transfer of an excess MWD resulting from an approved TOECR reorganization will be coordinated directly by MWD PM without additional documentation required by the owning command. The MWD authorization in WDMS will be updated by MWD PM as required after each force structure update is available in TFSMS.

#### 7104. Military Working Dog (MWD) Change

1. Introduction. MWD assets are currently managed in TFSMS as a component of the official T/E and reflected in a unit's table of organization and equipment (T/O&E) report. All Marine Corps MWD authorizations are identified in WDMS, which in turn is utilized by the 341 TRS to distribute MWDs to locations based on the priority as established by the MWD PM. The two types of MWD authorization changes are based on whether the requirement is the result of a personnel restructuring [see paragraph 7103] or the shifting of capability demands.

2. Capability Restructure. A command may determine that due to a shift in the local detection demand that it is necessary to change the MWD capability mix for drug/explosive without changing the number of handlers (a qualified handler can work both drug and explosive detector MWDs). See figure 7-1 for an example of a capability change request that is initiated from the owning command to the MWD PM [see Appendix C]. Upon approval of the capability request, the MWD PM will change the MWD capability authorizations in WDMS and create an initial order for the new capability which will show on the section status dashboard. The MWD PM will decide on the best course of action and timing to implement the change. See Appendix C about communicating with the MWD PM about force structure updates in WDMS.

Section 7200 - Military Working Dog (MWD) Acquisition

7201. Purpose. This section provides an overview of the Marine Corps unique procedures and policies associated with the acquisition of MWDs as necessary to supplement published procedures from the MWDEA per reference (h).

7202. Introduction. Under the MWDEA, the 341 TRS, JBSA-Lackland, TX is responsible for managing the acquisition process and procuring, training and distributing MWD assets to each military service. The Marine Corps sources all MP MWDs from the 341 TRS.

7203. Sourcing. Marine Corps commands are not authorized to use locally procured dogs for law enforcement purposes. The MWD PM will coordinate with the 341 TRS in exceptional cases where specialized MWD procurement or training must be obtained from other sources.

7204. Military Working Dog (MWD) Replacement. There is no formal procurement paperwork required by an MWD section that experiences an MWD loss. The MWD replacement process will not be initiated until final disposition documentation has been submitted per instructions in section 7300 and the 341 TRS removes the MWD in WDMS. Once the MWD is removed from service, the MWD PM will assign a shipment destination priority against the Marine Corps annual allocation of trained MWDs from the 341 TRS as established by the Joint Service MWD Committee (JSMWDC). Inquiries about MWD replacement orders in WDMS shall be directed to the MWD PM (see Appendix C).

Section 7300 - Military Working Dog (MWD) Disposition

7301. Purpose. This section provides an overview of the procedures and policies associated with the disposition and out-processing of MWDs.

**IMPORTANT**

An MWD shall not be promised to any person/agency in advance of the disposition submission/approval process as defined in this section.

7302. Introduction

1. Definition. Disposition package submission is the process of removing an MWD from the USMC T/E. An MWD service status normally changes due to poor health or performance issues.

2. Exceptions. The process as described in this section does not include:

a. "New" MWD to be returned to the 341 TRS [see section 5300].

(1) Owning MWD Section provides MWD PM with veterinarian letter and WDMS training records since arrival at the base.

(2) MWD PM will coordinate return of the MWD with the 341 TRS and provide the MWD Section with a transfer letter.

b. MWD is still operational [although not required due to restructuring].

(1) See paragraph 7104 on submitting a request for excess MWD assets.

(2) The MWD PM will coordinate reassignment location and provide the MWD Section with a transfer letter.

c. MWD unexpected death [see paragraph 8204].

d. Serious injury or death of the current handler.

(1) If the Secretary of the military department concerned determines that an adoption is justified given the circumstances under which the handler of an MWD is wounded in

action, the MWD shall be made available for adoption only by the handler.

(2) If the Secretary of the military department concerned determines that such an adoption is justified given the circumstances under which the handler of an MWD is killed in action or dies of wounds received in action, the MWD shall be made available for adoption only by a parent, child, spouse, or sibling of the deceased handler.

(3) In both above circumstances, coordination with the MWD PM office will be required to complete the adoption packages.

#### 7303. Preparation

1. Evaluation. Each KM must continuously evaluate MWD team performance and initiate action per section 5300 when there is a failure to maintain required readiness levels. Final action will be to initiate the disposition package process as described in this section.

2. Coordination. The KM shall coordinate with the VCO if the MWD ability to perform required duties comes in question.

3. Recording. Corrective action efforts must be noted in the comments section of the monthly MWD Activity Reports (NAVMC 11818-1) since these records will be submitted with the disposition request.

#### 7304. Disposition Package

1. Submission. Reference (h) provides the instructions for preparing a disposition package and submitting it to the 341 TRS via the MWD PM (See Appendix C).

**IMPORTANT**

Disposal requests are submitted via the electronic safe access file exchange.  
Current exchange user instructions are in the WDMS library.

**NOTE**

KM needs to contact MWD PM if regional vet holds adoption package over 30 days.



2. Package Content. As a supplement to reference (h), the following USMC specific instructions apply to processing a disposition package to the MWD PM.

- a. Figure 7-2 provides an example request letter.
- b. All forms are to be legible.
- c. All MWD disposition packages must include the following:

- (1) MWD Recommended for Adoption. Recommendation [for or against] must be substantiated and stated in the MWD Adoption Suitability Checklist.

- (2) Bite Muzzle Test Assessment Form.

- (3) Bite Muzzle Test Video.

7305. Execution of Department of Defense (DoD) Decision

1. Schedule. Once the KM receives the excess letter, the owning command has 30 working days to complete the MWD transfer out of the kennel. The MWD PM is to be advised if there will be a delay or for assistance: i.e., locating a suitable adopter.

2. Cost Responsibility. The owning command is responsible for all costs associated with disposition of an excess MWD with the following exceptions:

- a. When the 341 TRS specifically requests that the MWD be returned to JBASA-Lackland, TX then shipping costs are paid by the 341 TRS.

- b. When the MWD is adopted, the adoptee pays the transportation cost.

3. Adoption Priority

- a. The owning command has final decision and selects the adopter per the following priority set forth in reference (h).

- (1) Former handlers of the animal

- (a) In situations where multiple handlers have requested to adopt a particular MWD, the owning command will make the final adoption determination based on the best circumstances for the retiring MWD (i.e., home and yard space,

24 FEB 2020

access to veterinary treatment, financial consideration for food and veterinary treatment, etc.)

(b) The owning command is not responsible for updates to a potential adopter's contact information; this is the potential adopter's responsibility. When an MWD is declared excess, the owning command representative (i.e., the KM) will make reasonable attempts to contact the first priority adopter. If the individual cannot be contacted within five working days, the command will move on to the next potential adopter and document this process in a memorandum for the record (MFR) in the MWD service record.

(2) Other persons capable of humanely caring for the animal

(3) Law enforcement agencies

b. KM is to brief each new handler on arrival of MWD adoption options with emphasis on submitting requests in writing. The handler is responsible for ensuring the adoption package is completed and on file with the KM before transferring from the kennels.

c. KM is to ensure copies of handler adoption requests are maintained in the MWD active service record (see figure 8-9).

d. KM is to forward handler adoption requests to MWD PM for entry into WDMS.

4. Disposition Restrictions. The following restrictions apply to the disposition of an excess Marine Corps MWD:

a. No sale to an individual or commercial organization.

b. No transfer to any agency (i.e., medical research and development, or clinical investigation) for the purpose of invasive research/training that would potentially compromise the health of the MWD.

c. Local VCO Requirements. The local VCO SOP may require additional MWD section actions for the adoption process to include, but not be limited to, VCO briefing the adopter of any medical treatment that may be needed to care for the MWD.

24 FEB 2020

5. Documentation. The following Manual sections provide details about the documentation requirements for specific disposal situations:

a. MWD Transfer. See table 8-7 [MWD Service Record Retention] and paragraph 8203 [Shipping].

b. Local MWD Disposition. See table 8-9.

7306. Working Dog Management System (WDMS) Entries

1. Disposition Package Submission Date. The KM shall record the request submission date in WDMS [KM/MWD Mgmt tab]. The MWD PM will record, in this tab, the date the package was forwarded to the 341 TRS.

2. Military Working Dog (MWD) Status. Refer to Appendix H for instructions on changing the MWD status in WDMS after the disposition package has been submitted. Changing the MWD status will highlight the MWD as pending removal in status dashboards.

7307. Training Requirements for Military Working Dogs (MWDs) in Disposition Process. Generally, MWDs in the disposition process are assigned a caretaker handler pending the results of the review board. The following direction is provided depending on the nature of the disposition:

1. Training Disposition. Unit should maintain the caretaker training standards at minimum per table D-4C until MWD is declared excess.

2. Medical Disposition. Unit should maintain a conditioning program as specified by the VCO.

3. Declared Excess & Not Fit for Service. Once the MWD is declared as excess and no longer fit for service, the unit may maintain the conditioning routine in table D-4C until the MWD leaves the kennel, unless otherwise adjusted by VCO recommendation.

4. Declared Table of Equipment (T/E) Excess for Transfer. Once the MWD is declared as T/E excess and fit for transfer to another assignment, the unit should maintain caretaker training standards at minimum per table D-4C until the MWD leaves the kennels.

Section 7400 - Changing Military Working Dog (MWD) Capability

7401. Purpose. This section provides an overview of the procedures and policies associated with adding or removing an MWD capability.

7402. Request Process

1. Submission. Whether adding or removing a capability that impacts the NSN, the owning command must initiate a change request to the 341 TRS via the MWD PM (see Appendix C).

2. Content. The request must include the following documentation depending on nature of the change:

a. Add Capability

(1) A letter requesting an addition of an MWD capability. See figure 7-3 for an example.

(2) Evaluation LAFB 375 [for specific skill-see Appendix E] signed by authorized DoD evaluator attesting to fact that MWD completed qualification events in the added capability. Testing of MWD will be coordinated through the MWD PM.

b. Remove Capability

(1) A deficiency letter that states corrective actions taken and results of corrective actions. See figure 7-5 for an example. This letter is normally submitted in advance to obtain approval to start processing a disposition package.

(2) A letter requesting removal of an MWD capability. See figure 7-4 for an example.

(3) In the case of an MWD medical condition, a VCO letter justifying removal of capability designator. The letter should state the MWD medical condition and provide any limitations that affect training or job performance.

7403. Changing DD 1834. Once the 341 TRS makes the NSN change in WDMS, the KM updates the appropriate entry change in the original copy of the MWD form DD 1834, section "RECORD OF FORMAL TRAINING" [see Appendix E] with pen changes.



[COMMAND LETTER HEAD]

EXAMPLE

5585

Date

From: PM/PC

To: USMC MWD Program Manager, HQMC, Security Division (PS),  
Washington, DC 20350-3000

Subj: REQUEST FOR CHANGE OF MWD CAPABILITY AUTHORIZATION

Ref: (a) USMC MWD Manual [MCO ID]

1. Per References (a), the following change to the Table of Equipment authorization is requested for Military Working Dogs (MWD) at this command:

T/E	MWD Authorization by Type		
	Patrol Explosive	Patrol Drug	Total
Current	8	4	12
Requested	6	6	12

2. Requested change will provide a better balance of drug detection assets to meet our increased commitment to the war on drugs at this facility.

3. Request that the new authorization be in place by [date] understanding that this command is responsible to cover cost of transferring MWDs to meet this objective. Receipt of a single purpose drug MWD is acceptable but it must be suitable for future patrol training and certification.

4. Point of Contact: [command POC, contact information]

\_\_\_\_\_  
Signature (PM/PC)

Figure 7-1.--Example MWD Capability Authorization Change Request



[COMMAND LETTER HEAD]

EXAMPLE

5585

Date

From: PM/PC

To: USMC MWD Program Manager, HQMC, Security Division (PS),  
Washington, DC 20350-3000

Subj: REQUEST DISPOSITION INSTRUCTIONS, MWD SILVER/F588

Ref: (a) USMC MWD Manual [MCO ID]

Encl: (1) MWD Silver Activity Reports, [6 month period]  
(2) MWD Adoption Suitability Checklist  
(3) Medical Documentation  
(4) Bite Muzzle Test Assessment Form [if req'd]  
(5) Bite Muzzle Test Video [if req'd]

1. Per References (a), enclosures (1) to (5), along with the information to following, are submitted for disposition instructions for the subject Military Working Dog (MWD).
2. MWD Sivler/F588 is a (age, sex, breed, training classification) MWD that (synopsis of problem and what has been done to try to correct the problem).
3. The MWD temperament is (provide a recommendation, example, usefulness as a training aid at the 341 TRS, suitable for adoption, euthanasia).
4. Request this MWD be declared excess to the DoD.
5. [if adoption applicable] A suitable local adoption candidate has/~~has not~~ been identified. SSgt Marine is a former handler of MWD Silver and is highly recommended for this opportunity if the disposition decision is for adoption.
6. Point of Contact: For additional information please contact (Kennel master's name, phone, email address).

\_\_\_\_\_  
Signature (PM/PC)

Figure 7-2.--Example MWD Disposition Request



[COMMAND LETTER HEAD]

**EXAMPLE**

5585

Date

From: PM/PC

To: USMC MWD Program Manager, HQMC, Security Division (PS),  
Washington, DC 20350-3000

Subj: REQUEST FOR ADDED MWD CAPABILITY, MWD BLACK/H734

Ref: (a) USMC MWD Manual [MCO ID]

Encl: (1) AF Form 375, Patrol

1. Per References (a), enclosure (1) is submitted as evidence that MWD Black/H734 has successfully been certified in the MWD Patrol capability.
2. The certification was conducted at the command on [date] and evaluated by the 341<sup>st</sup> TRS representative, Mr/Ms, [name].
3. Request this MWD be assigned the NSN 882-00-0188-3880 for Patrol/Explosive Detection Dog.
4. Point of Contact: For additional information please contact (Kennel master's name, phone, email address).

---

Signature (PM/PC)

Figure 7-3.--Example MWD Capability Add Request



[COMMAND LETTER HEAD]

**EXAMPLE**

5585

**Date**

From: PM/PC

To: USMC MWD Program Manager, HQMC, Security Division (PS),  
Washington, DC 20350-3000

Subj: REQUEST FOR REMOVED MWD CAPABILITY, MWD TEX/G123

Ref: (a) USMC MWD Manual [MCO ID]

Encl: (1) Deficiency Report  
(2) Veterinarian Letter (*if medical condition*)

1. Per References (a), enclosures (1) and (2), along with the information to follow, are submitted to support this request for removal of Patrol capability for the subject MWD.

2. MWD Tex/G123 is a (age, sex, breed, training classification) MWD that (synopsis of problem and what has been done to try to correct the problem).

3. Request this MWD be assigned the NSN 882-00-043-3526 for Explosive Detection Dog.

4. Point of Contact: For additional information please contact (Kennel master's name, phone, email address).

---

Signature (PM/PC)

Figure 7-4.--Example MWD Capability Remove Request





[COMMAND LETTER HEAD]

EXAMPLE

5585  
Date

From: Kennel Master, Unit

To: Military Working Dog Evaluation Section, Lackland AFB, San Antonio, TX

Subj: DISCREPANCY REPORT IN THE CASE OF MWD KORAN J135

Ref: (a) USMC MWD Manual [MCO ID]

1. MWD Koran J135 is a 9 year 7 month old German Sheppard Patrol Drug Detection Dog (PDDD). His performance has been progressively going downhill and is now becoming a liability due to his inconsistency during detection and patrol training. Below is a list of his deficiencies along with corrective actions taken and results.

a. Deficiency. During detection events, MWD walks aids showing no change of behavior (COB) consistently even after the handler presents them multiple times.

(1) Corrective Actions. The handler/trainer tried assisting MWD into a response and also tried paying on sniff to get the MWD to recognize, from odor comes reward (All aids for this MWD are at nose level and very shallow).

(2) Results. MWD continues to walk odor with no COB and shows little interest. The MWD showed little to no improvement and consistently missing 3-4 out of 6 training aids during detection events.

b. Deficiency. MWD shows very little drive for the primary reward.

(1) Corrective Actions. The handler/trainer tried utilizing multiple forms of rewards (i.e., tug, rope, Kong and ball) to see if the MWD would better respond to a different reward. Also, conducted sessions of reward drive training.

(2) Results. MWD still shows little to no interest in his primary reward, which in turn is affecting detection training. During drive training, it was very hard to get the MWD interested enough to chase and follow the reward. Once the MWD receives reward, he will hold it for a few seconds then drop

Figure 7-5.--Deficiency Report (1 of 2)

it and wander away. With the Kong on a rope, MWD will not play; he will just let go and let the handler have the reward.

c. Deficiency. MWD will stop actively searching after 10-15 minutes into an event and no longer respond to handler commands. MWD needs improvement in his stamina.

(1) Corrective Actions. MWD was put on a PT regiment. The handler took MWD for a run or conducted line drills every day. It started as only 15 minutes but eventually grew to 30 in length.

(2) Results. MWD doesn't seem to be as tired during searches but still continues to stop actively searching during the event and no amount of activity from the handler entices him to continue to be productive. He just goes with the motions.

d. Deficiency. MWD has little to no drive for bite work during patrol training. The MWD will go through the motions but does not commit to the bite and many times is beaten to the decoy by the handler. MWD will not bite and hold; he only grabs the decoy then quickly releases.

(1) Corrective Actions. The decoy tried to ramp the situation using a whip which caused the MWD to be alert and bark while the whip was in hand. The decoy also tried bite drive training to harness the MWD prey and defensive drive.

(2) Results. MWD shows not improvement. During prey drive training, the MWD will not commit to the chase. He trots around careless of the decoy. When trying to aggress on the MWD to induce defensive drive, the MWD will quickly go into avoidance and run from the decoy. We will have to use very little agitation in order to get the MWD to stay focused on the decoy and stay out of avoidance.

2. MWD is not capable of successfully passing the patrol and explosive detection validations required by Reference (a).

---

Signature (Kennel Master)

## Chapter 8

### Administration

#### Section 8000 - Working Dog Management System (WDMS)

8001. Purpose. This section provides an overview of the DoD supported, web-based information system, WDMS that is the key tool to the MWD community for communicating the availability and capability status of MWD and personnel resources throughout the Marine Corps.

#### 8002. Introduction

1. The Marine Corps MWD Program has developed a service unique activity data repository within a larger DoD level data base called WDMS. The WDMS is a software program that provides full life cycle management of the identity, medical status, training, operational assignment, and disposition of MWDs that have been evaluated, acquired, and deployed by DoD and other Federal agencies participating in the MWD Program. This Program was developed to reach a worldwide user base and is web-based, operating on a framework permitting worldwide access via the internet and local area networks (LAN). Status/activity recording, reporting and ad hoc querying can be performed. The main module was developed and implemented by the 341 TRS acting under the MWDEA. The WDMS allows one-time entry of MWD activity data and provides leadership at all command levels with those management and planning tools necessary to support an effective MWD capability.

2. The Marine Corps module within WDMS is designed to be the single, authoritative source that supports the service specific business processes for identifying and tracking MWD and personnel resources, capturing essential MWD team activity and qualification information, and monitoring operational trends. As such, it is mandatory for all MWD sections to fully utilize this management tool per this Order.

**CAUTION**

WDMS is installed on a military non-secure network. Precautions must be taken to restrict the recording of specific information about MWD activities that are classified.

3. Website Link. The Marine Corps WDMS module is accessible at: <https://WDMS.CCE.AF.MIL>.

8003. Working Dog Management System (WDMS) Access. Personnel directly involved in the operations and leadership of the Marine Corps MWD Program will be provided user access into the Marine Corps WDMS service module to accomplish those roles defined later in this section. The process of gaining access authorization begins by the MWD PM recording the individual into the personnel directory for the assigned MWD section.

1. Advance Personnel Recording. If notified by the MWD section, the MWD PM will record newly assigned personnel in WDMS so that handler assignments and activity reporting can be accomplished by the trainer while the handler's system access documentation is being processed. Refer to Appendix C for instructions on conducting an advance personnel recording in WDMS.

2. On-The-Job Training (OJT) Personnel. Paragraph 3106 describes OJT as it applies to military and civilian personnel assigned to the MWD section. OJT personnel are authorized to obtain WDMS user access for the purposes of recording training activities with an MWD when teamed as a caretaker (see paragraph 8104). Personnel records for those in the OJT program will be identified with the WDMS occupation code of "OJT" [Note: occupation code is controlled by the MWD PM.] The OJT identifier will be shown in WDMS team screen headers to readily distinguish non-MOS handlers. Kennel Masters are to use the WDMS trouble ticket to notify the MWD PM of changes required to the occupation code after the requirements for the handler MOS are completed.

3. Documentation

a. Each individual who is to gain access to the web-based WDMS must do the following:

(1) Submit a completed DD 2875, Security Authorization Access Request (SAAR) [per instructions in Appendix E]. Contact the MWD PM for questions [see Appendix C].

(2) Be issued a current Government Common Access Card (CAC).

b. The SAAR form is initiated by the requesting command to obtain access into WDMS. Within five calendar days of submission, the requestor should receive an email notification with instructions about WDMS login. The CAC must be inserted

into the computer card reader when logging into the WDMS website.

c. Transfers. For personnel, with WDMS access, who make a permanent change of station (PCS) or permanent change of assignment (PCA); the receiving MWD section should request a WDMS change to the MWD PM [see Appendix C]. In this situation, a new SAAR is not required.

d. Military to Civilian Service. For personnel leaving the MWD military service and returning as a civilian MWD handler; the receiving MWD section should request a WDMS change to the MWD PM [see Appendix C]. In this situation, a new SAAR is not required.

4. System Login. Each new user will receive a temporary password to be utilized for the first WDMS login. This is the last time a login password will be required unless a user account is reset after being locked or when a new CAC is issued.

a. Locked Login. A user can be locked from accessing WDMS by either of the reasons described below and reset by action of an individual with access rights per table 8-1.

(1) The user incorrectly enters the initial password three times, or

(2) an individual with access rights of KM or above selects the locking function in the personnel profile.

b. New CAC Issue. Depending on the changes made on a newly issued CAC, the user account may have to be reset if login problems are encountered. An individual with KM rights or above can reset the user's profile account which results in the issuance of a temporary password required to complete the initial login process.

c. Account Validation Date. The account validation date is established at the time of the successful initial user login. On an annual basis, the validation date is updated when the user follows instructions that require verifying contact information in the program personal profile. Having a current account validation date indicates that the user has system access and is actively utilizing it.

**NOTE**

Users should not confuse the above WDMS Account Validation Date with the MWD team Validation Date described in Chapter 5.

5. Functional Levels. The Marine Corps WDMS is organized into major categories to facilitate access into the system to perform activity recording, activity planning, performance review, readiness monitoring, and resource planning and assignments. The categories below are the system functional levels which are represented by separate action tabs that are accessible based on the user rights.

a. Handler. The individual, either military or civilian, who is assigned to an MWD to form an MWD team. The handler works at this level to primarily record MWD activities. Trainers work at this level to develop detection qualification events.

b. Kennel Master. The senior personnel, either military or civilian, [e.g., KM, trainer] who are directly responsible for the operations of the MWD section work through this functional level to define the organization structure, rate training events, and monitor team activities.

c. Command. The senior leadership, either military or civilian, who are directly responsible for providing direction on the employment of MWD teams can monitor the status of all command MWD sections through this functional level.

d. Program Management. The MWD PM support staff, military, civilian and contractor, are responsible to obtain and align MWD team assets throughout the Marine Corps and, through this function level, coordinate assignments and respond to priority deficiencies.

6. User Rights. Individuals who will be working in Command, KM, trainer, or handler billets will be granted access into WDMS based on user's responsibilities. Table 8-1 provides information about each user right category to include what tasks can be accomplished.

24 FEB 2020

Table 8-1.--WDMS User Rights		
CATEGORY	USER ASSIGNMENT	USER TASKS (1)
Command (2)	<ul style="list-style-type: none"> <li>• Personnel identified as having a requirement to monitor status of one or more specifically assigned MWD sections.</li> <li>• [LE Bn] <u>Non-5812</u> persons assigned to the billets of: <ul style="list-style-type: none"> <li>- Platoon Commander</li> <li>- Platoon Sgt</li> </ul> </li> <li>• Subject to approval and entry of name in personnel file by the MWD PM</li> </ul>	<ul style="list-style-type: none"> <li>• View overview section(s) status dashboard.</li> <li>• Generate fixed format status reports for assigned MWD sections.</li> </ul>
Kennel Master	<ul style="list-style-type: none"> <li>• [Installations] Person holding the KM billet and one additional senior person designated by the KM.</li> <li>• [LE Bn] <u>5812</u> Persons assigned the billets of: <ul style="list-style-type: none"> <li>- KM</li> <li>- Chief Trainer</li> <li>- Three Squad Leaders</li> </ul> </li> </ul>	<ul style="list-style-type: none"> <li>• Edit capability in the assigned section KM and Handler function tabs.</li> <li>• Access to the Command tab.</li> <li>• Manage personnel assignments to include those on non-kennel status.</li> <li>• Assign WDMS (trainer, handler) user rights within section.</li> <li>• Enter team mission assignments and approve mission expense submissions.</li> <li>• Generate status reports for any recorded MWD activity.</li> <li>• Lock/unlock section personnel WDMS access.</li> <li>• Reset a user profile account when a new CAC is issued.</li> </ul>
Trainer	<ul style="list-style-type: none"> <li>• [Installation] Person assigned the trainer billet.</li> <li>• [LE Bn] As designated by the holders of KM rights.</li> <li>• KM has option to assign this user right to other personnel in the section.</li> </ul>	<ul style="list-style-type: none"> <li>• Edit capability in the assigned section Handler function tab [same as any handler rights in section].</li> <li>• Access to the KM and Handler dashboards and capability to generate status reports.</li> <li>• In the KM access tab, capability as defined below: <ul style="list-style-type: none"> <li><u>Edit:</u> <ul style="list-style-type: none"> <li>- MWD Management</li> <li>- Team Management</li> <li>- Event Rating Management</li> <li>- Reports</li> </ul> </li> <li><u>View:</u> <ul style="list-style-type: none"> <li>- Personnel Management</li> <li>- Mission Management</li> </ul> </li> </ul> </li> </ul>

Table 8-1.--WDMS User Rights		
CATEGORY	USER ASSIGNMENT	USER TASKS (1)
Handler	Section personnel assigned to the billets for handler.	<ul style="list-style-type: none"> <li>• Edit capability in the Handler function tab for the assigned MWD teams.</li> <li>• Enter team activity data for the current month and back to the previous month until the 15<sup>th</sup> of the current month.</li> <li>• Contact MWD PM to extend edit access if required [e.g., return from deployment].</li> </ul>
<p><b>NOTES:</b></p> <p>(1) All user rights allow access to the function keys at the top of the WDMS screen; e.g., Library, Profile, and Help Ticket</p> <p>(2) Command personnel are not included in the personnel on-hand figures for the MWD community.</p>		

8004. Working Dog Management System (WDMS) Help Ticket. Any user of WDMS can submit a help ticket to communicate WDMS related topics which may include, but are not limited to, reporting of system operating issues or data errors, requests for assistance in using the system, notification of MWD and personnel assignment relocation, and submission of suggestions for system improvement. Several personnel within the MWD Program office will automatically receive help tickets to ensure a broad visibility of potential system wide issues and to ensure expedient response. Priority will be given to address tickets that directly impact the reporting of the MWD section operational status. Users initiating tickets are strongly encouraged to include specifics [date, time, MWD name, Handler name, etc.] and to attach a screen image when possible. A ticket log is accessible through the ticket window to view the status of past tickets. Inquiries relating to a ticket should include the reference number assigned to each ticket.

8005. Support Requirements. To gain access into WDMS and generate required monthly activity and management reports, each MWD section must have sufficient organic information technology (IT) capability. Refer to table 9-3 for a guideline on the types and quantity of technology that are recommended for an efficient MWD operation.



Section 8100 - Military Working Dog (MWD) Section Procedures

8101. Purpose. This section outlines and articulates those procedures each MWD section will utilize to conduct effective administration of transactions and record keeping that is unique to the MWD community.

8102. Section Operations Binder. Each KM shall have a section operations binder that contains documentation pertinent to the effective management of an MWD section. Appendix F provides the table of contents for the section operations binder. The actual size of the binder will vary depending on the organizational structure and operating complexity of the MWD section which may result in the requirement to maintain multiple binders as preferred by the KM. Some binder content is required [as indicated in the appendix] and some material is discretionary. The sequence of the binder layout should follow Appendix F as close as possible to ensure continuity within the Marine Corps MWD community.

8103. Military Working Dog (MWD)-Handler Teaming Assignments

1. The key to obtaining effective MWD performance is to team the MWD with a handler who can maintain the focus and motivation of the MWD. Just like the handler, the MWD has a unique personality which must be taken into consideration when forming a team. Close monitoring by the KM and trainer is essential during the early stages of team training to ensure the MWD and handler work well together.

2. The ability to evaluate both the strengths and weaknesses of the handler and the MWD is a developed skill for the MWD section leaders.

a. Recording. Handler assignments are to be recorded on the MWD DD 1834 per with instructions in Appendix E.

b. Multiple Assignments. The intent in the construction of the MWD section is that only personnel assigned to "handler" billets will be teamed with an MWD. In situations of personnel shortages or conflicting assignments, it may be necessary to assign qualified personnel holding other billets [trainer or KM] to an MWD to provide care and sustain training for the purpose of recording in WDMS. During a period of anticipated prolonged personnel shortages, but only as a last resort, a handler may be teamed with multiple MWDs. Only one handler can be assigned to an MWD.

8104. Activity Recording and Reporting

1. Handler. The handler reports team activity data which includes utilization (employment of team capabilities), qualification (TVC process), and expenses associated with supporting DoD support missions.

a. Caretaker Assignment. In the situation that a handler is not available, the KM will assign a qualified individual (caretaker) to ensure the MWD is provided necessary care, exercise and skills training as defined by the KM or trainer to maintain minimum standards. The caretaker is assigned as the MWD handler within WDMS, but not for purposes of completing validation or conducting utilization duties. The caretaker is responsible to record WDMS entries daily skill training along with a "Caretaker Only" untrained/unutilized reason (see table 8-2). If the caretaker is holding the assignment at the end of the month, he/she will generate the MWD Activity Report (NAVMC 11818-1). Caretaker assignments are recorded on the MWD DD 1834 per instructions in Appendix E.

b. MWD Untrained/Unutilized Recording

(1) During the month, there are days when the handler and/or the MWD are not participating in utilization or qualification activities. To ensure a complete MWD picture is on record, table 8-2 describes the reasons, and associated MWD/handler status selections, that are available for the handler/caretaker to record the circumstances that best describe why the MWD was not engaged in activities. Advance entries of untrained/unutilized daily reasons can be made only to the end of the current reporting month.

(2) Additional clarification of the circumstance should be entered as basic skills comments so they will appear in the month end activity reporting synopsis [NAVMC 11818-1]. Comments can include details about MWD conditioning or odor familiarization.

24 FEB 2020

<b>Table 8-2.-- MWD Untrained/Unutilized Reasons</b>			
<b>Reason</b>	<b>Situation Description</b>	<b>Common Associated Status</b>	
		<b>Handler (see Table 8-4)</b>	<b>MWD (see Appendix H)</b>
Caretaker Only	Individual assigned as a caretaker in WDMS is responsible for the daily care and exercise of the MWD, but is not training with the MWD for validation. See table D-4C for guidelines on MWD training under a caretaker.	On-Hand- Unrestricted	<ul style="list-style-type: none"> <li>• @ Field Pending Disposition</li> <li>• Operational</li> <li>• Deployed</li> <li>• Training Deficiency @ Home (Trng Def-home)</li> <li>• Non-Operational Medical Working Quarantine</li> </ul>
Leave	Handler is on leave and not available to conduct training or perform duties with the MWD.	Leave	<ul style="list-style-type: none"> <li>• Operational</li> <li>• Deployed</li> </ul>
MWD in Transit	MWD is on route to a location away from the home base.	<ul style="list-style-type: none"> <li>• On-Hand- Unrestricted</li> <li>• On Mission</li> </ul>	<ul style="list-style-type: none"> <li>• Operational</li> <li>• On Mission</li> <li>• Deployed</li> </ul>
MWD Sick	MWD is ill or has an injury that restricts MWD to kennel or a medical facility and not capable of performing regular training or duties.	On-Hand- Unrestricted	<ul style="list-style-type: none"> <li>• Non Operational-Medical</li> <li>• Working Quarantine</li> <li>• @ Field Pending Disposition</li> <li>• Deployed</li> </ul>
MWD TAD/TDY (1)	MWD [or team] is away from home base for training or medical treatment.	<ul style="list-style-type: none"> <li>• On-Hand- Unrestricted</li> <li>• TAD</li> </ul>	<ul style="list-style-type: none"> <li>• Training TAD</li> <li>• Deployed</li> </ul>
Off Duty	Handler is not assigned to duties due to work scheduling or to handler illness/injury.	<ul style="list-style-type: none"> <li>• On-Hand- Unrestricted</li> <li>• On-Hand- Restricted</li> <li>• Medical</li> </ul>	<ul style="list-style-type: none"> <li>• Operational</li> <li>• Deployed</li> </ul>
On Call	Handler is permitted to be away from the kennel on personal time, but required to be readily available for return to duty.	On-Hand- Unrestricted	<ul style="list-style-type: none"> <li>• Operational</li> <li>• Deployed</li> </ul>
Other	Situation is not exactly defined in any listed category. Remarks should be included in Basic Skills comments.	<ul style="list-style-type: none"> <li>• Special Duty</li> <li>• Legal</li> <li>• PMO/OPS (2)</li> <li>• On Mission</li> </ul>	<ul style="list-style-type: none"> <li>• @ Field Pending Disposition</li> <li>• Trng Def-Home</li> <li>• Deployed</li> </ul>
Range	Handler is on training at the range for weapons qualification.	Range/Field Duty	<ul style="list-style-type: none"> <li>• Operational</li> <li>• Deployed</li> </ul>

24 FEB 2020

Table 8-2.-- MWD Untrained/Unutilized Reasons			
Reason	Situation Description	Common Associated Status	
		Handler (see Table 8-4)	MWD (see Appendix H)
TAD/TDY (1)	Handler is away from the home base on TAD orders.	TAD	<ul style="list-style-type: none"> <li>• Operational</li> <li>• Deployed</li> </ul>
<b>NOTES:</b> (1) TAD = Temporary Assigned Duty TDY = Temporary Duty (2) PMO/OPS = Provost Marshal Operations			

c. Activity Recording

(1) Introduction

(a) MWD team activity recording in WDMS is intended to show, as accurately as practical, the period of time beginning when the MWD is removed from the kennel run area and ending when it is returned.

1. Periods of transit time to off-base destinations are generally not considered as part of the daily activity time. Any time the MWD is not on-leash or receiving direct commands from handler while in transit should not be recorded as either qualification or utilization; but the handler should indicate in WDMS "MWD in Transit" (Untrained/Unutilized reason) and annotate in basic skills comments the total transport time to include drive to/from airport, time on flight, etc. If a handler is driving the MWD to a TAD location (e.g., from Camp Pendleton to Chicago), X hrs. of driving time is annotated in basic skills comments. Any time a handler stops to give MWD a break/exercise this will be tracked as basic skills qualification time. This procedure also applies to deployment movements as well.

2. Once at a remote location (TAD, deployment, etc.), only actual time out of temporary kenneling facility is recorded.

3. MWD break time in the compound run area should be included in the daily activity recording as an annotation of time in the basic skills comments.

(b) Recorded time is important since it reflects the level of attention given to the MWD in terms of qualification and utilization activities. The effectiveness of an MWD team is directly related to the amount of time the MWD actually works

with the handler and has the opportunity to repeatedly be exposed to the originally learned skills (i.e., basic skills, patrol, detection and tracking). Extended periods of kennel time is a waste of a valuable Marine Corps asset since the MWD skills diminish with time and require extensive man hours to retrieve lost MWD and team capabilities. Handlers are to ensure that the recorded total MWD daily activities do not exceed 24 hours nor does the total exceed the actual time the MWD was out of the kennel. Table 8-3 provides guidance on how MWD activities are to be recorded. Figure 8-2 provides example scenarios that illustrate this guidance being applied to recording MWD team activities.

Table 8-3.--MWD Activity Recording Guide		
MWD CAPABILITY	ACTIVITY TYPE	RECORDING GUIDANCE (1)
Basic Skills (2)	Utilization	<ol style="list-style-type: none"> <li>1. Time while in a Government vehicle for patrol duties.</li> <li>2. Time while on walking patrol.</li> <li>3. Time while at static post (only the lag time when not conducting searches - see Detection Utilization).</li> </ol>
	Qualification	<ol style="list-style-type: none"> <li>1. Time while basic skills activities (Obedience [on/off-leash], OB course, Gunfire) are being conducted for the specific purpose of TVC or demonstration.</li> <li>2. Time while conducting MWD physical conditioning run/walks.</li> <li>3. Time for MWD travel [recorded as "MWD In Transit"] for - <ul style="list-style-type: none"> <li>• to/from employment/TAD destination [including embark time].</li> <li>• to/from and other time involved associated with any qualification events.</li> <li>• to/from demonstrations on/off base.</li> <li>• to/from MWD medical facilities.</li> </ul> </li> <li>4. Time for the medical treatment or examination. (Once the MWD stays overnight at a medical facility, no activity time is recorded, but appropriate Untrained/Utilized status entry is necessary).</li> <li>5. Time while MWD is on-leash awaiting transit or any qualification activity.</li> </ol>
Patrol	Utilization	<p>Time while the MWD is directly employed in an actual law enforcement function involving controlled aggression, building search, scout or security escort.</p> <p><b>Note:</b> Any time involved with an MWD capability demonstration will only be recorded as Qualification.</p>

24 FEB 2020

<b>Table 8-3.--MWD Activity Recording Guide</b>		
<b>MWD CAPABILITY</b>	<b>ACTIVITY TYPE</b>	<b>RECORDING GUIDANCE (1)</b>
	Qualification	Time while patrol skill activities are being conducted for the specific purpose of training, validation or demonstration.
Detection	Utilization	Time while the MWD is directly employed in an actual law enforcement search for targeted substances. <b>Examples:</b> 1. Bumper-to-Bumper time conducting vehicle search while on RAM at the main gate [see Basic Skills Utilization for lag time recording]. 2. An off-leash search time from the time the MWD is released in the search area until the search is completed. <b>NOTE:</b> Utilization includes the time that the handler uses a drop aid to reinforce the MWD search behavior.
	Qualification	Time while detection events which are created in WDMS with the specific purpose of training, validation, certification or demonstration.
Tracking	Utilization	Time while the MWD is directly employed in a law enforcement or humanitarian track for lost personnel or targeted criminal suspects. Time starts when the MWD is introduced to the scent pad and ends when the tracking effort is terminated.
	Qualification	Time while tracking events which are created in WDMS with the specific purpose of training, validation or demonstration.
<b>NOTES:</b>		
(1) Refer to figure 8-2 for examples of recording activity.		
(2) Basic skills are also essential during patrol, detection and tracking activities, but it is important that the recorded time in basic skills is not duplicated in other activities.		

(2) Recording Frequency. It is recommended that daily activity be recorded by the end of the following day, but no later than the section reporting date defined in paragraph 8104.2.a.

(3) Deployed or On Mission MWD Teams. For MWD teams who are deployed or on mission, the handler should update their online activity records when they are able to gain access to the internet or within 30 calendar days of returning to their duty station. Deployment commanders are highly encouraged to provide

access to CAC computers with internet connection for handlers to update their records.

(4) Detection/Tracking Event Worksheets. To facilitate manually recording the results of detection and tracking events while they are conducted in the field, two forms are available for local printing. Forms MC MWD-1 (Det) and MC MWD-2 (Track) are discussed in Appendix E. There is no requirement that these forms be maintained at the MWD section after the results are recorded in WDMS; although, it is suggested the forms be held until the MWD activity report is printed for the month.

d. MWD Activity Requirements. MWD activity scheduling must support the following minimum readiness and training standards along with meeting command operational requirements:

(1) Section Performance Metrics. The following section performance metrics measure the organization's activities as they relate to effective use of MWD assets [**metrics are tracked in WDMS "Statistics Report" available in the WDMS KM report tab**]:

(a) MWD On-Hand Days Accounted. Guideline is **99% or higher**. Indicates the completeness of the MWD records in WDMS. Equates to the percentage of Total Days with Entry\* in WDMS divided by the Total Days MWD On-Hand during the reporting period.

<p>*A WDMS <u>entry</u> applies when -</p> <ul style="list-style-type: none"><li>➤ activity time is recorded <u>or</u></li><li>➤ reason for Untrained/Unutilized noted</li></ul>
--

(b) Average Dog Day. Guideline is **2.0 hours or higher**. Indicates level of MWD attention provided. Equates to total activity hours divided by the number of days the dog is on-hand during the reporting period. Details on the supporting analysis of average dog day is available in the WDMS library.

(c) Days On-Hand with Activity. Guideline is **45% or higher**. Indicates consistency of MWD attention provided. Equates to the percentage of the MWD on-hand days that have any recorded activity time during the reporting period.

(d) Operating Status. Guideline is "**Limited**" status or higher. Indicates level of section readiness and ability to maintain team validations. See section 8300 for details.

(e) Utilization to Qualification Ratio. Guideline ratio is **2.5 or higher** for validated MWD teams. Indicates the level of support being provided in relation to the qualification effort expended. Equates to total utilization hours divided by the total qualification hours during the reporting period.

(2) Training. Meet training standards of tables D-4.

(3) MWD Conditioning. MWD participates in physical conditioning per tables D-4.

e. MWD Activity Rating. The handler is responsible for rating the MWD performance for utilization activities and training in Basic Skills and Patrol.

f. MWD Activity Report. A monthly report [NAVMC 11818-1] shall be generated for each MWD during the assignment to the MWD section. This ensures that a complete activity trail, both for training and utilization, is available for future review and analysis. NAVMC 11818-1 focuses on the total MWD activity picture and provides an effective management tool that requires regular review of MWD involvement and performance trends. In the absence of an assigned handler, the designated MWD caretaker or trainer is responsible to generate the report.

(1) Review Guideline. By the **10<sup>th</sup> day** of the following month, the KM, or designee, should have reviewed and signed all monthly MWD reports [with exception of those MWDs away from the kennel on deployment, mission, or training exercise] per instructions provided in Appendix E.

(2) Record Keeping. Completed reports shall be maintained in the MWD Service Record per instructions provided in paragraph 8106.

(3) Changing WDMS Records. WDMS team activity records shall not be revised once the NAVMC 11818-1 report has been



signed and filed. Contact the MWD PM for further guidance on this Policy [see Appendix C].

2. Kennel Master. The KM system function encompasses leadership activities conducted by the KM and trainer.

a. WDMS Recording Deadline. To ensure a consistent status picture at all command and headquarters levels; MWD section leaders will ensure that all MWD, personnel, and qualification information is current to the best degree possible by -

**2300 [Eastern Standard Time] each Monday.**

The MWD section operating status will be computed in WDMS by 0800 [Eastern Standard Time] each Tuesday. This weekly computed operating status will be used as the basis to monitor trends and establish corrective actions described in paragraph 8306. The KM should include procedures and define responsibilities in the MWD section SOP to support meeting this reporting deadline.

b. MWD Section Status Reporting. Because WDMS is the authorized data repository for MWD status and activity recording, there is no requirement for MWD sections to generate any scheduled section status reports unless specified by the chain-of-command. Information may be requested by the chain-of-command for clarification of WDMS entries or a special update during the period between the WDMS recording deadline specified in paragraph 8104.2.a.

c. MWD Team Activity Rating. The trainer is responsible to rate the MWD team performance for all training detection and tracking activities. The KM is responsible to evaluate and rate team validation and certification events. The KM and trainer review and sign the monthly MWD activity reports and designate by signature that the report is accurate to the best of their knowledge and that the data reflected in the NAVMC 11818-1 is the same as recorded in WDMS.

d. Personnel Record. MWD section leaders will ensure that the personnel record information, to include schools attended, credit card, and passport, are updated as required.

e. OJT Personnel. Paragraph 3106 describes the On-The-Job (OJT) program as it applies to military and civilian personnel assigned to the MWD section. OJT personnel are those who have not qualified for the MWD handler MOS [5812 (Military) or 0083 (GS)], but are performing limited MWD related duties during the

interim until all prerequisites have been completed. OJT personnel are authorized to obtain WDMS user access (see paragraph 8103.2) for the purposes of recording training activities. Personnel records for those in the OJT program will be identified with the WDMS occupation code of "OJT" [Note: occupation code is controlled by the MWD PM.] The OJT identifier will be shown in WDMS team screen headers to readily distinguish non MOS handlers. Kennel Masters are to use the WDMS trouble ticket to notify the MWD PM of changes required to the occupation code. All other WDMS personnel status information applies as applicable to OJT personnel.

f. Personnel Management. Once the MWD PM enters new personnel into WDMS [see section 8000], the MWD section will maintain the following activity status categories of MWD trained personnel:

**NOTE:**

It is optional for the MWD section to report status changes for personnel who are expected to return to "On Hand-Unrestricted" in less than seven calendar days.

(1) Active Personnel. Personnel, both military and civilian, who perform work that is directly related to MWD activities and under the supervision of the KM. Unless there is a situation of excess personnel, each of the active personnel will be assigned a BIC. Table 8-4 describes situations for the person status codes that relate to active MWD section personnel. These categories are consistent with those used for the Marine-On-Line (MOL) morning reports.

(2) Active - Non-Kennel Personnel. Personnel, both military and civilian, who hold 5812 MOS/0083 police officer, to perform MWD related duties, but have been assigned duties outside the MWD section; e.g., duty driver, patrolman, watch commander. Table 8-4 describes situations for the person status codes that relate to Active Non-Kennel personnel. A person in this status may return to performing duties within the MWD section in the future, at which time the status is changed in WDMS. Personnel will automatically lose WDMS login rights and MWD section BIC assignment upon being coded as Active-Non Kennel.

**NOTE:**

58XX MOS monitor considers "Active-Non Kennel" personnel to be qualified and accessible to the MWD section. For this reason, the monitor will not transfer 5812 personnel to fill kennel open billets if sufficient personnel are already assigned to the base. The KM needs to ensure that the 5812 MOS is administratively removed thru MWD PM action if personnel do not intend to hold a 5812 billet.

(3) Inactive Personnel. Personnel who leave the MWD community for a "B-Billet" (i.e., recruiting, drill instructor, embassy duty) or end of active service. The MWD section shall submit a WDMS trouble ticket requesting removal of the individual from the MWD section along with a brief description of the change reason. The MWD section must close all MWD team assignments before the individual can be classified as "Inactive" by the MWD PM.

<b>Table 8-4.--Person Status</b>	
<b>PERSON STATUS CATEGORY(1)</b>	<b>SITUATION</b>
<b>ACTIVE PERSONNEL</b>	
Deployed (2)	Marine has departed the MWD section and is in route to/from, or participating in, an operating force support commitment.
Leave	Individual is assigned to the MWD section and is on authorized leave.
Legal	Individual is assigned to the MWD section, <u>not physically present</u> and on legal hold with specified duty restrictions.
On Mission (2)	Individual is assigned to the MWD section and is in route to/from, or participating in one of the following activities: 1. DoD sponsored support <u>as identified by a mission assignment number in WDMS</u> . 2. Command directed operational support not classified as deployment to include- * HMX-1 off-base MWD team assignments * LE Bn MWD team assignment to the base PMO * LE Bn MWD team detached from a unit and assigned to a military operational unit (example: Marine Expeditionary Unit (MEU)) to conduct integration training prior to a deployment.
On Hand - Unrestricted	Individual is assigned to the MWD section and physically present to perform all duties without restrictions.

<b>Table 8-4.--Person Status</b>	
<b>PERSON STATUS CATEGORY(1)</b>	<b>SITUATION</b>
On Hand - Restricted	Individual is assigned to the MWD section, physically present, but cannot perform all MWD support duties.
Medical	Individual is assigned to the MWD section and has been admitted to a medical facility that requires being away from duties.
Range/Field Duty	Non MWD related activities required to maintain military and law enforcement skills of both military and civilian personnel.
Temporary Assigned Duty (TAD)	Person has departed the home MWD section and is in route to/from, or participating in, a professional skills development course or any other command directed assignment.
<b>ACTIVE NON-KENNEL PERSONNEL</b>	
PMO/OPS	Individual is assigned to duties within the PM office or company functions.
Special Duty	Individual is directly supporting local command functions and has been permanently assigned on a non-section duty.
<p><b>NOTE:</b></p> <p>(1) An individual will normally start as "On Hand-Unrestricted" after assignment to an MWD section. Other status situations will be relatively short in duration then return to "On Hand-Unrestricted" until the individual is transferred or leaves the service.</p> <p>(2) Reporting that the handler status is different than that of the MWD [see Appendix H] will result in MWD team readiness reported as "NOT READY"</p>	

g. MWD Status. During the period of active assignment in an MWD section, the MWD will be reported as one of the status categories described in Appendix H.

**NOTE:**

It is optional for the Military Working Dog (MWD) section to report MWD status changes that are expected to be in effect to return to "Operational" in less than seven calendar days.

h. Command Chronology. At the beginning of the new month [or when all previous month activity is recorded], the KM should generate the Command Chronology Report (MC MWD-4) in WDMS [see Appendix E]. This report should be reviewed for accuracy as it

24 FEB 2020

reflects the MWD section utilization and training activity for the selected period. Discrepancies need to be corrected by changing the appropriate individual handler entry. This process needs to be completed prior to the final signing of the NAVMC 11818-1 for the previous month. The chronology report will be a primary source for command requested reporting normally required at least on an annual basis if not monthly.

3. Command. Leadership personnel using the WDMS command function will, depending on the number of assigned personnel and MWDs, be capable of viewing personnel, MWD, and team readiness status information as maintained, real time, by the MWD section. Although this access does not allow revision of data, the user can generate preformatted reports that provide relevant status information supporting the MWD section operational status.

#### 8105. Military Working Dog (MWD) Team Qualification Documentation

##### 1. Introduction

a. Information and records relating to the qualification of all MWD teams must be maintained due to the nature of their work which has legal implications on humans to include detection of illegal substances, search and apprehension of offenders, and crowd control. The team qualification process serves as a means of quality control to ensure continued team reliability. This section provides the instructions concerning the necessary documentation and procedures that will show evidence of a team's ability prior to conducting an assignment; whether patrol, detection, or tracking. The following Manual topics are related to those in this section:

(1) Chapter 5 [MWD Team Readiness] - defines the qualification process.

(2) Appendix D [Qualification] - defines the standards necessary for a team to achieve and maintain an acceptable level of performance.

b. All qualification forms are to be generated from WDMS utilizing recorded activity data. In the unlikely situation that WDMS is out-of-service for an extended period or the MWD section loses access to the system, the MWD PM will provide, on request (see Appendix C), necessary qualification forms in digital format so the reports can be handwritten while the system is not available. Kennel Masters are to ensure all

24 FEB 2020

handwritten qualification forms are properly recorded in WDMS once the system is operable. Generating and signing new forms is not necessary in this situation.

2. Qualification Reporting. MWD team qualification is evaluated and reported in two categories; validation as a Marine Corps requirement, and certification as a local installation requirement.

a. Validation

(1) On successful completion of the evaluation and generation of the validation reports [see table 8-6]; the KM, or designee in his/her absence, signs the document indicating that the validation was conducted per Appendix D. Senior MWD section members, qualified in the specific MWD capability, can be appointed by the KM as evaluators for any individual validation event and their names will be recorded in WDMS and on the validation report generated from WDMS.

(2) The validation results along with beginning and end dates are recorded in WDMS and readily available for review and confirmation of team qualification by system users at higher command and the MWD PM. The original signed hardcopy validation reports are maintained in the MWD service record [see paragraph 8106] for purposes as a backup to WDMS, for inspection and legal review.

b. Certification. Within five calendar days of the successful completion of the evaluation and generation of the certification report [NAVMC 11818-23 (Detection Certification)]; the KM, or designee in his/her absence, and the witnessing search granting authority (designee) signs the document indicating that the certification demonstration was conducted per Appendix D. The signed original report is filed in the MWD Service Record [see paragraph 8106] and a copy is provided to the signing witness if requested. Trainers, by billet assignment, in the MWD section can be appointed by the KM as evaluators for any individual events and their names will be recorded in WDMS and on the certification report generated from WDMS.

3. Revoking a Qualification. Paragraphs 5204 and 5205 define the criteria for revoking both the MWD team validation and certification and specify action that must be taken to adjust the team qualification records. This section provides instruction on the required documentation of the status change.

a. Validation. Within two working days of the decision to revoke an MWD team validation, the KM shall complete the following actions:

(1) Establish the validation revoke effective date in WDMS.

(2) Annotate the last MWD team validation report in the same manner as shown on figure 8-3.

(3) Explain [handwritten] reason for revoking the validation in the comments section on the front of the form. If required, additional text on a blank white sheet can be inserted behind the revoked form.

(4) Record the revoked validation in WDMS [KM/Team Mgmt Tab/Qual Data] by editing the applicable validation screen with the specified end date.

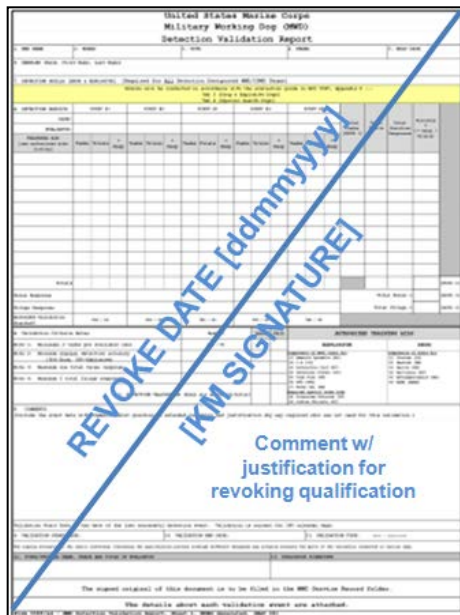

Figure 8-3.--Example  
Team Validation Revoke Annotation

b. Certification. Within two working days of the decision to revoke an MWD team certification, the KM shall complete the following actions:

(1) Establish the certification revoke effective date in WDMS.

(2) Send a certification revoke letter to the search granting authority (see figure 8-4).

(3) File a copy of the revoke letter in the MWD Service Record folder per figure 8-9.

(4) Annotate the last MWD team certification report (NAVMC 11818-23) in the same manner as shown on figure 8-3.

(5) Record the revoked certification in WDMS [KM/Team Mgmt/Qual Data] by editing the certification screen with the specified end date.

4. Non-Availability of Training Aids. In the situation that a training aid is not available for an MWD team (with a current certification) for over 35 calendar days and the team is expected to continue supporting probable cause searches, the KM will initiate the following action:

a. Send a training aid non-availability letter to the search granting authority (see figure 8-5). The letter shall be to the search granting authority in advance of the last date any MWD team will be qualified on the odor in question.

b. File a copy of the letter in the MWD Service Record folders of those MWDs impacted per figure 8-9.

c. Non-availability of required aids may result in limited validation and certification reports (see paragraphs 5204 and 5205) if the aid is not utilized in the qualification events. Loss of an aid does not require conducting a new limited detection validation or certification.

5. Qualification Grace Period. Paragraphs 5204 and 5205 defines exceptions to expiration of the MWD team qualifications under special circumstances and specifies action that can be taken to grant a 30 calendar day grace period. This subparagraph provides instruction on the required documentation of the status change:

a. Validation. Prior to the time that the MWD team is assigned to operational status after the return of the team, the KM shall complete the following actions if granting a grace period is in the best interest of the Marine Corps:

(1) Initiate an MFR (see figure 8-6).



(2) File a copy of the MFR in the MWD Service Record folder per figure 8-9.

(3) Record the grace period in WDMS [KM/Team Mgmt/Qual Data] by editing the applicable validation screen, selecting the grace period feature and entering the TAD return date.

b. Certification. Prior to the time that the MWD team is assigned to operational status after the return of the team, the KM shall complete the following actions if granting a grace period is in the best interest of the Marine Corps:

(1) Send a request for a certification grace period to the search granting authority (see figure 8-7).

(2) File a copy of the MFR in the MWD Service Record folder per figure 8-9.

#### 8106. Military Working Dog (MWD) Records

##### 1. Introduction

a. When an MWD is procured, an administrative record file is initiated by the 341 TRS, along with a veterinary health record. Once assigned to a Marine Corps MWD section, the MWD administrative file is transferred to the section where the Marine Corps MWD Service Record folder is created as depicted in figure 8-8. The service folder consists of the original record documents plus those generated by the MWD section. The MWD service record becomes a permanent file that will follow the MWD through the life of the MWD.

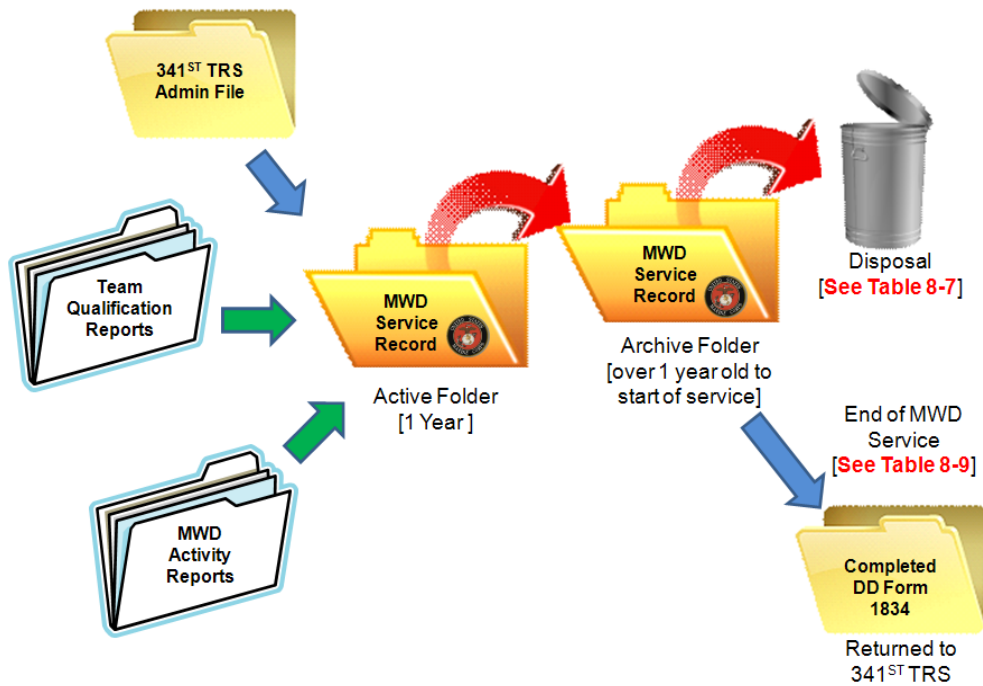

Figure 8-8.--MWD Service Record Concept

b. The veterinary record will be forwarded to the supporting veterinary clinic where the record file will be maintained and transferred as required as the MWD moves to other assignments. Additional information about the MWD medical record is provided in section 10100.

## 2. 341 TRS Military Working Dog (MWD) Administrative Record

a. This record file consists of the following forms initiated by the 341 TRS:

- (1) MWD Service Record (DD 1834)
- (2) MWD Qualification Form (LAFB 375) (see table 8-5)

b. The original copies of these forms will be maintained in the MWD Service Record folder, as explained in the following paragraph.

## 3. Military Working Dog (MWD) Service Record

a. Upon first assignment of the MWD to an MWD section, the KM will ensure that the MWD Service Record is created per the guidance provided in this section. The record will consist of MWD service life of activity organized in two folder sets,

**Active** [current to past month #12] and **Archive** [past month #13 to beginning of service life], that are organized in the format described. At any one time, these paper records are to be available for review and inspection. Historical activity information is available from the WDMS digital records. Since MWD records are subject to unannounced command and legal review, attention must be given by the MWD section to ensure that the MWD Service Record folders include the current activity information [within five working days of status change] and are in good condition. Instructions are provided in Appendix E for completing the listed forms and reports.

b. Original MWD Service records will not be removed from the supporting unit location; although, copies for a "Travel MWD Record" folder (see section 8203) can be prepared for the handler.

c. Active Record. The contents of the active MWD Service Record folder is intended to reflect the MWD qualification and activity covering the past 12 months to current.

(1) Configuration. Figures 8-9 thru 11 provide an overview of the configuration of the active MWD service record folder. To provide continuity for the service records, folders will be maintained in the sequence illustrated in the figures. Other documentation relating to the MWD in the past year (e.g., citations, news articles, log of deployments, court documents) will be located at the rear of the active folder. **Use Form MC MWD-9, MWD Service Record Checklist to confirm the correct configuration of this folder.**

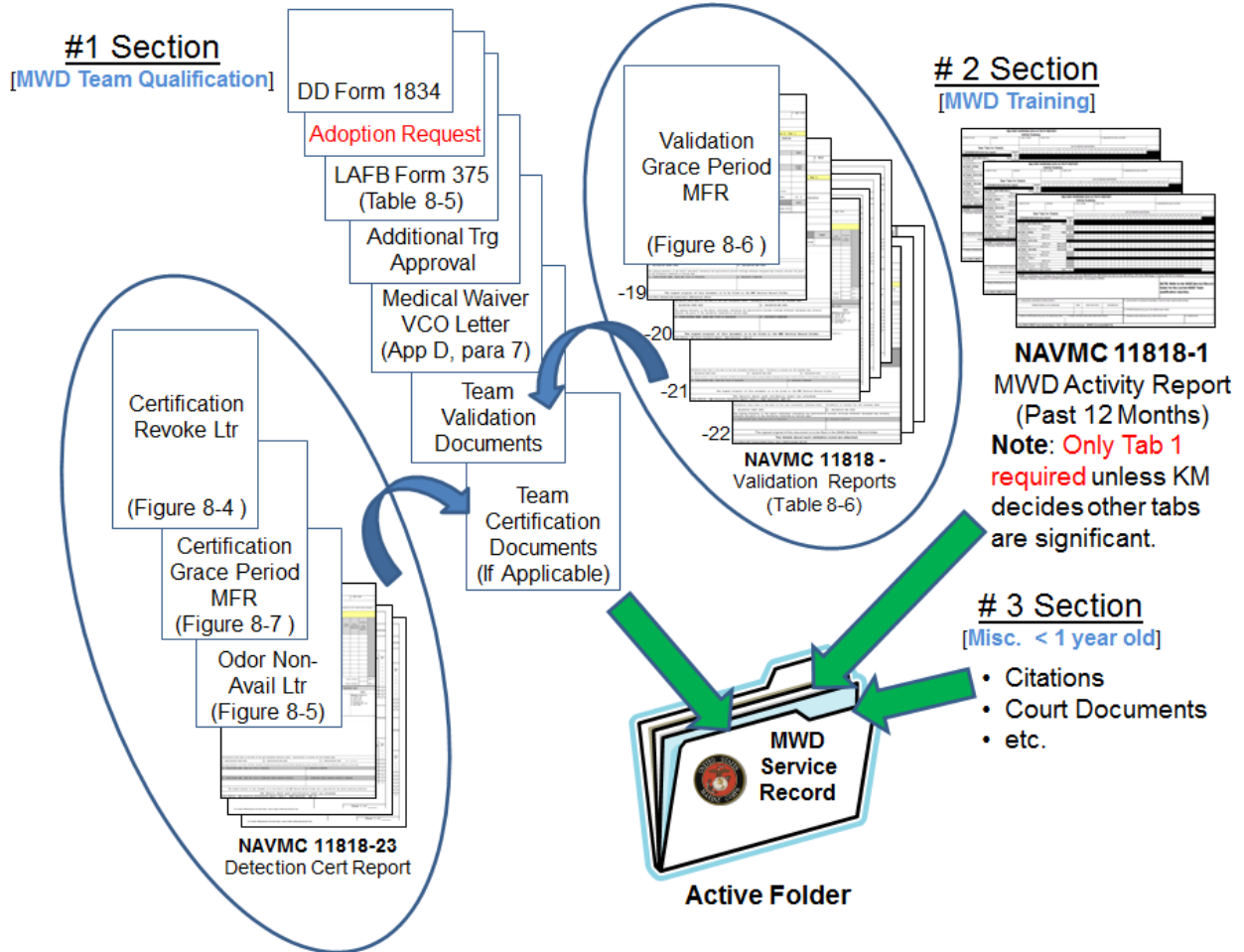

Figure 8-9.--MWD Service Record - Active Folder

**RECORDKEEPING NOTES:**

- Only current validation (Val) and certification (Cert) reports are maintained in the active MWD service record folder unless the last report was revoked in the past 12 months; in which case the documentation of such stays in the folder until the team Val/Cert report becomes current or a new handler is assigned.
- Only Tab 1 of NAVMC 11818-1 is required to be maintained in the MWD service record [Active/Archive] unless the KM decides other tab(s) are deemed to be significant for future reference (i.e., major finds, training deficiencies, medical, and pending legal action).

Table 8-5.--LAFB Form 375 Configurations				
MWD Type	Form Identification			
	LAFB 375 Patrol Dog Qualification	LAFB 375 Tracking Dog Qualification	LAFB 375 Detector Dog Qualification	LAFB 375b & c SSD Qualifications
CTD		X		
DDD			X (Drug)	
EDD			X (Explosive)	
PDDD	X		X (Drug)	
PEDD	X		X (Explosive)	
SSD				X

Table 8-6.--Team Validation Report Configurations				
MWD Type	Report Identification			
	NAVMC 11818-19 Basic Skills Validation	NAVMC 11818-20 Patrol Validation	NAVMC 11818-21 Detection Validation	NAVMC 11818-22 Tracking Validation
CTD	X			X
DDD	X		X (Drug)	
EDD	X		X (Explosive)	
PDDD	X	X	X (Drug)	
PEDD	X	X	X (Explosive)	
SSD	X		X (Explosive)	

(2) Folder Type. Each MWD section has the option to select an available durable folder that is best suited for the local storage conditions; although, all MWD folders should be uniform in appearance. Partitions, dividers, and fasteners can be utilized in the folder at the discretion of the KM.

(3) Contents. Appendix E includes images and instructions for forms used in the MWD service record along with information on how it is used in the management of MWD activities.

d. Archive Record. The contents of the archive folder are intended to reflect the MWD qualification and activities for the MWD service life period prior to the active MWD service folder. At the end of each recording month, the last month in the active folder is to be moved to the archive. Multiple folders may be required.

(1) Configuration. Figure 8-10 provide an overview of the configuration of the archive MWD service record folder. To provide continuity for the service records, folders will be maintained in the sequence illustrated in the figure. The miscellaneous documents at the rear of the folder can be maintained in the folder as long as required at the KM's discretion. **Use Form MC MWD-9, MWD Service Record Checklist to confirm the correct configuration of this folder.**

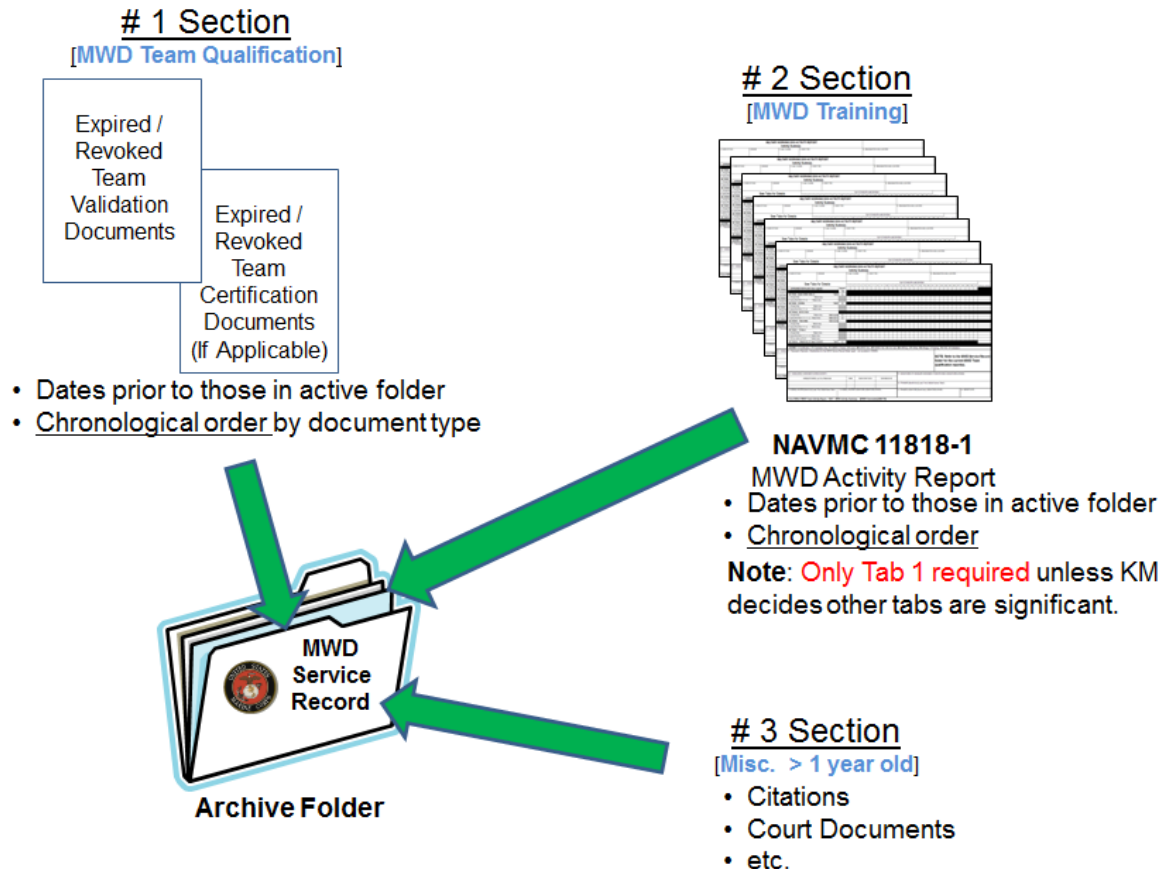

Figure 8-10.--MWD Service Record - Archive Folder

(2) Folder Type. Shall be consistent with that used for the active record.

(3) Record Retention. Commands with MWDs are responsible to maintain the hardcopy MWD qualification and activity documents during and beyond the MWD service life per the instructions in table 8-7 depending on the reason for the MWD loss.

**IMPORTANT:**  
To clarify the directive in references (a) and (aq): MWD Service Records (Active or Archive) are not to be returned to the MWD PM unless specifically directed to do so by HQMC.

<b>Table 8-7.--MWD Service Record Retention Guide</b>	
<b>REASON FOR LOSS (1)(4)</b>	<b>INSTRUCTIONS (2)</b>
Adoption	Retain an original copy of the <u>active</u> [w/copy of DD 1834 and adoption papers] and <u>archive</u> MWD Service Record for a period of <u>two years</u> .
<ul style="list-style-type: none"> <li>• Death</li> <li>• Death-Euthanized</li> <li>• KIA</li> <li>• MIA</li> </ul>	Retain the original copy of the <u>active</u> [w/copy of DD 1834 and death certificate (DD 1743)] and <u>archive</u> MWD Service Record for a period of <u>two years</u> .
<ul style="list-style-type: none"> <li>• Inter-Service Re-assignment</li> <li>• Intra-Service Re-assignment</li> <li>• Return LAFB</li> </ul>	<ol style="list-style-type: none"> <li>1. Send original MWD record (Active and Archive) to the gaining command at the time of transfer. [<b>see NOTE (3)</b>]</li> <li>2. Retain a copy of the <u>active</u> MWD Service Record for a period of <u>two years</u>.</li> </ol>
Transfer to LEA	<ol style="list-style-type: none"> <li>1. Send original MWD service record folder (Active [w/copy of DD 1834] and Archive) to the LE agency at the time of transfer. [<b>see NOTE (3)</b>]</li> <li>2. Retain a copy of the <u>active</u> MWD Service Record for a period of <u>two years</u>.</li> </ol>
<p><b>NOTES:</b></p> <p>(1) Refer to Appendix H for additional information about MWD loss comments.</p> <p>(2) Process MWD documents per local procedures for disposing of unclassified records.</p> <p>(3) <u>Unless hand carried by the handler</u>, MWD Service Records, will be sent separately, via traceable courier service, directly to the receiving MWD section attention the KM (unless provided another contact). Documentation should be shipped within <u>seven calendar days</u> of the MWD departure date.</p> <p>(4) See table 8-9 for final documentation of all dispositions.</p>	

8107. Inspections/Visits. Due to the nature of MWD care, high level of team qualification, and critical requirements for MWD capability; the MWD section should expect to be subject to some form of MWD related inspection and performance evaluation from higher commands and other Government agencies. Table 8-8 provides information about the types of inspections/visits and guidance on preparation for the event. Inspection reports will be filed in the MWD section operations binder (see Appendix F) for a period of one year.

Table 8-8.--MWD Section Inspection / Visit Guide		
TYPE OF INSPECTION (1)	PURPOSE	PREPARATION GUIDANCE
Major Subordinate Commander's (MSC) Commanding General's Inspection Program (CGIP)	<ul style="list-style-type: none"> <li>• Normally every <u>two years</u></li> <li>• Preparation for IGMC</li> <li>• Review section operating status</li> <li>• Review maintenance requests</li> </ul>	<ul style="list-style-type: none"> <li>• Focus on status of IGMC inspection items</li> <li>• Ensure team data current in WDMS</li> <li>• Update maintenance request folder</li> </ul>
Inspector General of the Marine Corps' (IGMC) Command Inspection Program (CIP)	<ul style="list-style-type: none"> <li>• Normally every <u>three years</u></li> <li>• Determine level of compliance with the current Functional Area Checklist per reference (z).</li> </ul>	<ul style="list-style-type: none"> <li>• Be prepared to demonstrate status of items in the guidelines published in reference (z). [go to link: <a href="https://www.hqmc.marines.mil/igmc/Units/Inspections-Division/Functional-Area-Checklists-FACs/">https://www.hqmc.marines.mil/igmc/Units/Inspections-Division/Functional-Area-Checklists-FACs/</a> to download the list for MWD Operations 5585]</li> <li>• The checklist <u>may</u> vary for base and LE Bn MWD sections.</li> <li>• Ensure that the contents of the section operations binder are current [see Appendix F].</li> <li>• Ensure documentation is available to justify reason for anticipated discrepancies.</li> </ul>



Table 8-8.--MWD Section Inspection / Visit Guide

TYPE OF INSPECTION (1)	PURPOSE	PREPARATION GUIDANCE
Veterinarian	<ul style="list-style-type: none"> <li>• Conducted at least quarterly by the supporting U.S. Army Veterinarian.</li> <li>• Examination of facility safety hazards and distractions that may interfere with the rest and relaxation of the MWDs.</li> <li>• Review of the adequacy of the facility structure and feeding/watering schedules. The VCO should make recommendations to help prevent disease and injury.</li> <li>• A review of the sanitation and cleaning procedures and MWD food storage procedures to minimize the risk of disease transmission to the MWD.</li> </ul>	Be prepared to demonstrate status per reference (x) and DD 2342, Animal Facility Sanitation Checklist. (2)
Drug Enforcement Agency (DEA)	<ul style="list-style-type: none"> <li>• DEA inspections are unscheduled without notice.</li> <li>• Check for drug aid accountability and security.</li> </ul>	Ensure drug aid documentation and physical inventory logs are completed in accordance with current reference (aa).

Table 8-8.--MWD Section Inspection / Visit Guide		
TYPE OF INSPECTION (1)	PURPOSE	PREPARATION GUIDANCE
Explosives Safety Self-Assessment (ESSA)	<ul style="list-style-type: none"> <li>Formal program by which installations conduct on-going appraisals of ammunition and explosives operations per reference (an).</li> <li>Complete ESSA will be conducted by each installation on an annual basis by the command Explosives Safety Officer (ESO) with unit personnel.</li> </ul>	<ul style="list-style-type: none"> <li>Ensure documentation is current.</li> <li>Primary focus is on those MWD sections that store explosive training aids at a facility other than an ASP and must comply with the USMC Qual/Cert Program.</li> <li>Comply with references (ae) and (an).</li> </ul>
HQMC Explosives Safety Inspection (ESI)	<ul style="list-style-type: none"> <li>COMMARCORSYSCOM conducts ESIs on a biennial basis per the schedule in reference (an).</li> </ul>	<ul style="list-style-type: none"> <li>Comply with the provisions of references (ae) and (an) to maintain and enhance the command's explosives safety posture.</li> </ul>

24 FEB 2020

Table 8-8.--MWD Section Inspection / Visit Guide		
TYPE OF INSPECTION (1)	PURPOSE	PREPARATION GUIDANCE
MWD Program Manager	<ul style="list-style-type: none"> <li>• Bi-annual planned visit for familiarization with facilities and section operational status.</li> <li>• Check selection of MWD service records to validate entries made in WDMS.</li> <li>• Assist sections with continued inadequate section operating status (see section 8300).</li> <li>• Provide requested specialized training in related topics such as of MWD training, WDMS, new KM orientation, and equipment requirements.</li> </ul>	<ul style="list-style-type: none"> <li>• Ensure MWD team status and kennel facility information is updated in WDMS.</li> <li>• Ensure MWD service record folders are current per guidance provided in paragraph 8106.</li> <li>• When classes will be presented, ensure adequate classroom and presentation equipment is available.</li> </ul>
Public / Courtesy Visits	<ul style="list-style-type: none"> <li>• Familiarization with MWD operations and military MWD facilities.</li> <li>• Observe demonstration of MWD capabilities.</li> </ul>	<ul style="list-style-type: none"> <li>• Review demonstration guidelines in Appendix J.</li> </ul>
<p><b>NOTES:</b></p> <p>(1) Inspections <u>can be unannounced</u> although, historically, sections are given advance notice.</p> <p>(2) A copy of the completed DD 2342 is normally provided to the KM by the inspecting VCO.</p>		

Section 8200 - Military Working Dog (MWD) Processing

8201. Purpose. This section outlines and articulates those policies associated with the key MWD lifecycle movement activities of Receiving, Shipping and Local Disposition.

8202. Receiving

1. Introduction. MWDs are assigned to Marine Corps units by the MWD PM. Upon arrival at the unit, the MWD will be added to the Commanding Officer's controlled material record (CMR) by the Supply Officer (SupO). This transaction will be conducted using a shipping document or DD 1348-1A, Issue Release/Receipt Document. The SupO can assign the MWD, by the specific TAMCN, as nonexpendable property to the MWD section Responsible Officer (RO) [normally the KM]. The RO will manage all transactions to and from his/her account to include issuing of equipment to individual handlers per command custody procedures and reference (w).

2. Documentation

a. Bill of Lading. Each MWD, either shipped from the 341 TRS or another source, will be accompanied by a bill of lading which will have to be signed by the receiving individual and a copy of such maintained per command supply procedures.

b. Medical. See paragraph 10202.3 for requirements for MWD medical examination on arrival at a new location or returning from an extended assignment.

c. 341 TRS. Normally, the MWD records (341 TRS Administration Record and Medical Record) are attached to the MWD shipping kennel marked to the attention of the KM. Documentation not received with the MWD should be reported immediately to the MWD PM (see Appendix C).

d. Inter & Intra-Service. In the case of a transfer between two MWD sections, the receiving section shall acknowledge receipt of the MWD Service Records, via email or phone, to the KM of the shipping section. See table 8-7 for MWD service record transfer requirements.

### 3. Working Dog Management System (WDMS) Transactions

a. The MWD PM will coordinate with the 341 TRS, or any other shipping location, to ensure MWDs are assigned to the proper MWD section within WDMS. By the time of arrival at the receiving section, the MWD should be identified by name/brand as assigned to the section [NOTE: An MWD should not be assigned to an MWD section prior to the actual shipment of the MWD]. Within seven calendar days of delivery, the receiving section shall record the actual arrival date [as noted on the signed bill of lading] in WDMS [KM/MWD Management] as the "COMMAND GAIN DATE" [normally the effective date that the MWD was added to the unit CMR]. The gain date is important since it directly impacts the computation of the MWD availability and in turn the team readiness. Any discrepancy between the WDMS MWD record and the actual MWD documents (e.g., wrong sex, breed) are to be reported, via a WDMS trouble ticket, for correction [Copies of supporting documentation may be requested].

b. The gaining section will report the MWD status as "Operational" in WDMS on arrival unless some unusual situation occurs in which another status applies. The MWD PM must be notified when a receiving MWD is not considered operational (see Appendix C).

### 2. Transport Equipment

a. 341 TRS. The MWDs received from the 341 TRS normally will be shipped in 341 TRS transport kennels. These kennels are the property of the 341 TRS and are not included with the procurement of the MWD. Kennels received or borrowed from the 341 TRS will be returned to the 341 TRS within 90 calendar days after the receipt. The expense for return shipment will be the responsibility of the gaining command. The MWD PM will notify the MWD section of any exception or change to this Policy.

b. Intra-Service. When equipment, primarily the transport kennel, is received with an MWD or a team from another USMC MWD section, the losing command will decide whether to turn over custody of the equipment to the gaining section or pay to have the equipment returned.

c. Inter-Service. Equipment received on an inter-service transfer will be returned to the shipping organization at the gaining unit expense.

8203. Shipping

1. Policy

a. Unless otherwise directed by the MWD PM, the owning command is responsible for funding the transport of MWDs for reasons to include:

- Medical care
- Transfer
- Non-operational support
- Deployment (operational support)

This responsibility includes escorting personnel and associated expense when required.

b. The MWD PM approves and initiates official correspondence for all shipments for an MWD re-assignment to another location [see Appendix C].

c. MWD Traveling Requirements. The following requirements apply for MWD traveling under the stated scenarios:

(1) In Commercial Aircraft Cabin. In the interest of public safety and liability to the Government, having the MWD travel in airline cabin with the handler should only be done as a last resort. The MWD will be muzzled.

(2) CONUS Commercial (includes 50 states). The MWD will be shipped as cargo and a qualified escort is not required.

(3) OCONUS Commercial. A qualified handler will accompany an MWD on international flights.

(4) Military Aircraft. A qualified handler will accompany an MWD transported by military airlift.

2. Documentation. Depending on the type of transportation, the following documentation is involved in the process of shipping an MWD and many cases must accompany the MWD:

a. Travel Orders. When the handler accompanies the MWD on commercial transportation, the handler's travel orders form [DD 1610, Request and Authorization for TDY Travel of DoD Personnel] shall include statements "Traveling with military Working Dog" and "Excess Baggage Authorized" as entered in DTS [block 16 remarks].

24 FEB 2020

b. Government Bill of Lading (GBL). [Applies when shipping MWD as cargo]. Each MWD will be accompanied by a bill of lading [DD 1348-1A] which includes the statement "LIVE ANIMAL- MILITARY WORKING DOG". Also, include feeding and watering instructions on the GBL so that the MWD can be cared for if there are delays en route.

c. MWD Health Certificate. A signed DD 2209, Veterinary Health Certificate is required to accompany any MWD on an interstate or international movement. The following specifics apply:

(1) The MWD section initiates the request for the VCO to inspect the MWD and medical records as required to complete the form.

(2) The form must be completed and dated by the VCO within ten calendar days prior to the travel arrival date.

(3) This form records the MWD health and rabies vaccination status.

(4) A copy of the health certificate must be displayed in a clear bag on the top of the transport kennel.

(5) MWD health requirements and documentation may vary by country so the MWD section should confirm the requirements of the destination country well in advance of international travel.

d. MWD Certificate of Acclimation/Fitness for Travel. Commercial airlines require a Certificate of Acclimation/Fitness for Travel MFR be presented prior to an MWD boarding the plane. Ground carriers may require the letter especially during periods of extreme weather temperatures. Figure 8-1 is an example of the MFR prepared and signed by the VCO. The document should be completed at the same time as the Health certificate. MWD sections should contact the carrier prior to any MWD movement to confirm the current documentation requirements.

e. MWD Service Record. The following provides MWD record requirements that are based on the reason for MWD travel:

(1) Transfer from Section. See table 8-7 for records that can be carried by the handler or sent direct to the new location.

24 FEB 2020

(2) Unit Movement. When an MWD is transported to support a unit activity [i.e., TAD, deployments and non-operational missions (exceeding 30 days)] and accompanied, the handler shall carry a "Travel Copy" [also referred to as "Deployment Record"] consisting of a copy of the following documents from the active MWD Service folder and Medical record:

- (a) Current Validation Reports.
- (b) Last three months of MWD activity reports.
- (c) Deployment medical folder [prepared by the VCO].

3. TSA Security. When processing through a Transportation Security Agency (TSA) inspection station, unarmed USMC military/civilian personnel, accompanied by an MWD, can request to be cleared directly into the sterile area upon inspection of the following documents which were discussed above:  
[**Note:** Handlers need to keep all credentials, IDs, and orders on hand throughout the process, not put them in check-in luggage.]

a. Two forms of Government issued photo ID, including the military identification card.

b. Travel Order [DD 1610] (see paragraph 8203.2.a.).

c. MP credentials.

d. Passport (for international travel).

e. If asked for a Unique Federal Agency Number (UFAN), the handler shall professionally ask the TSA personnel to refer to the Aviation Security, Specialized Screening, Standard Operating Procedures, section 2.3.1. (Armed or Unarmed LEOs entering the sterile area), paragraph A, subparagraph 6, page 2.5. It states, "An unarmed U.S. military member, accompanied by a canine, may be cleared into the sterile area after inspection of his or her Military Identification Card (DD Form 2XX), Request and Authorization for Temporary Duty travel of DoD Personnel (DD Form 1610), another form of Government-issued photo ID, and if flying, his or her travel document. A UFAN is not required."

4. Working Dog Management Sysmten (WDMS) Transactions. The MWD PM will coordinate permanent MWD transfers within WDMS. Whether the MWD shipment results in temporary or permanent relocation, the MWD status within WDMS will normally change so it is



24 FEB 2020

necessary for the losing/gaining commands to make appropriate WDMS entries per Appendix H within seven calendar days of departure.

5. Transportation Equipment. The transport kennel shall be the best fit for the MWD as specified in table 9-1. The transport kennel and necessary handling equipment will be transferred with the MWD when the MWD is reassigned.

6. Transportation Considerations. The following guidance shall be considered when making MWD shipping arrangements:

a. The MWD team should be routed on the most direct mode by using cost-effective transportation with the least number of stops and transfers as possible.

b. When booking flights, transportation officers and port call activities should ensure that the airline is advised that the passenger (handler) is authorized excess baggage consisting of shipping crate, a live animal, dog food, and assorted dog-handling equipment.

c. Local procedures should ensure that the necessary information on port call is provided to all persons involved to include the handler, the KM, and the transportation officer.

d. When shipped airfreight, provide by priority message (and by phone, if possible) other movement information (carriers, flight numbers, dates, and times of departure and arrival) to the Military Traffic Management Command (MTMC), the Military Air Traffic Coordinating Unit (MATCU), the installation or activity nearest any connecting airport, and the gaining unit or installation, as appropriate. Movement control personnel will provide additional guidance to ensure maximum visibility of MWD.

e. MWDs should arrive at the airport as near to flight time as possible, but not more than four hours before flight time.

f. The MWD should be given potable water within four hours, but not less than two hours before flight time.

g. For unescorted travel, a handler from the receiving command shall physically take custody of the MWD within four hours of the MWD arrival.

h. Include the appropriate food and bottled water along with instructions to accompany the MWD.

(1) Affix the feeding/watering instructions to the outside of the shipping crate and include them on the GBL so that the MWD can be cared for if there are delays en route.

(2) Instructions should state to provide potable water at least once every 12 hours and food at least once every 24 hours.

i. Confirm with the carrier in advance that the air temperature in any holding area will not be allowed to fall below 45 degrees Fahrenheit (°F) or to exceed 85°F at any time while the MWD is in transit.

j. Ship the MWD at night during hot weather, if possible, to avoid unsatisfactory temperatures in the carrier holding area.

k. Commercial Airline Restrictions. Restrictions for transporting an MWD vary by airline, type of aircraft and even by airport. Kennel masters should contact the airlines in advance to determine if any of the following apply:

(1) Animal heat embargo is imposed during specified periods with route climate temperature limit [normally 85°F between 15 May to 15 September].

(2) Limit of MWDs in cabin

(3) Limit of MWDs in cargo area

(4) Limit on total weight of MWD plus kennel

(5) Advance feeding of food/water

(6) Advance check-in

(7) Location of check-in

(8) Kennel design & size requirements [See para. 9005]

(9) Quarantine requirement [primarily OCONUS]

8204. Disposition. The action taken by the MWD section will constitute a "disposition" when an MWD:

- Departs unexpectedly [including missing-in-action (MIA), runaway, stolen, natural causes, euthanasia and hostile action (KIA)]; or
- is locally processed out-of-service [includes adoption and transfer to LEA]; or
- is transferred to another DoD organization [includes JBSA-Lackland, other USMC MWD section (Intra-Service), and other service branch (Inter-Service)].

Section 7300 describes the MWD disposition request submission and approval process. Once the section receives the approval for disposition or circumstances require immediate local action, the following specific procedures apply:

1. Notification of Unexpected Military Working Dog (MWD) Loss. For unexpected MWD death [unknown, natural causes, traumatic injury or KIA] or MWD missing for any reason [runaway, stolen, MIA]; the MWD section is to immediately notify the VCO, chain-of-command and the MWD PM within 24 hours (see Appendix C).
2. Disposition of Deceased Military Working Dog (MWD). Per reference (x), the installation commander is responsible to dispose of deceased MWDs per state and local regulations. MWD sections are encouraged to maintain a commemorative symbol of deceased MWDs in the form of a picture gallery, cemetery, or a single monument in the area of the kennel. In no cases are preserved remains, or parts, to be maintained in the kennel. Consideration for an official use of a deceased MWD; i.e., taxidermy for purposes of museum or historical display, must be submitted to the MWD PM for approval [see Appendix C].
3. Adoption Transportation Equipment and Costs. It is recommended that the MWD be turned over to the adopting individual with one collar and one six-foot leash, provided at the KM's discretion. No other government equipment is authorized to be furnished to the adopting individual. All transportation costs associated with the delivery are at the expense of the adopting individual [either pickup at kennel or arrange commercial carrier].

4. Documentation. See table 8-9 for document submission requirements for dispositions and table 8-7 for MWD record retention instructions as they apply for the MWD loss.

**IMPORTANT:**

The MWD will not be removed from the Marine Corps inventory in WDMS until MWD PM receives the documents specified in table 8-9. The MWD PM will then initiate replacement action as required.

<b>Table 8-9.--Final Documentation Of MWD Disposition</b>	
<b>REASON FOR Loss (1)</b>	<b>FINAL DISPOSITION DOCUMENTS TO MWD PM (2)(3)</b>
Adoption	<ul style="list-style-type: none"> <li>• MWD Service Record form (DD 1834) w/updates (4)</li> <li>• Copy of the completed <i>Covenant Not to Sue with Indemnity Agreement</i> (see reference (h)).</li> </ul>
<ul style="list-style-type: none"> <li>• Death</li> <li>• KIA</li> </ul>	<ul style="list-style-type: none"> <li>• MWD Service Record form (DD 1834) w/updates (4)</li> <li>• Signed MWD Death Certificate form (DD 1743)</li> </ul>
Death-Euthanized	<ul style="list-style-type: none"> <li>• MWD Service Record form (DD 1834) w/updates (4)</li> <li>• Signed MWD Death Certificate form (DD 1743)</li> </ul>
<ul style="list-style-type: none"> <li>• Inter-Service Re-assignment</li> <li>• Intra-Service Re-assignment</li> <li>• Return LAFB</li> </ul>	No requirement.
MIA	<ul style="list-style-type: none"> <li>• MWD Service Record form (DD 1834) w/updates (4)</li> <li>• Copy of any completed investigation reports for missing or stolen [DD 200, MLSR report, NCIS report, etc.]</li> </ul>
Transfer to LEA	<ul style="list-style-type: none"> <li>• MWD Service Record form (DD 1834) w/updates (4)</li> <li>• Copy of the completed <i>Covenant Not to Sue with Indemnity Agreement</i> (see reference (h)).</li> </ul>
<b>NOTES:</b>	
<p>(1) Refer to Appendix H for additional information about MWD loss comments.</p> <p>(2) Losing MWD section shall submit the final disposition documents to the MWD PM (see Appendix C) within <u>15 calendar days</u> of the declared MWD loss date [date of final action (death/adoption)].</p> <p>(3) At the KM's discretion, submission requirements may be extended during deployment or due to obtaining a completed investigation report, but MWD PM must be notified of any delay.</p> <p>(4) Original DD 1834 is preferred, but legible copy is accepted.</p>	

5. Working Dog Management System (WDMS) Transactions. The losing MWD section must end the MWD team assignment before an MWD can be removed from Marine Corps service within WDMS. Within seven calendar days of the MWD loss, the final MWD status shall be recorded per Appendix H.

Section 8300 - Military Working Dog (MWD) Section Operating  
Status

8301. Purpose. This section outlines and articulates those policies for reporting MWD section operational status and the associated actions required to correct deficiencies.

8302. Introduction

1. The operation of an MWD section is like none other in the Marine Corps due to it being the only operational unit that directly relies on the effectiveness of the teaming of a human [the handler] with an animal [MWD]. The KM must have a readily understandable means to communicate up the chain-of-command about MWD capabilities to support command commitments. In turn, senior commands must be able to quickly identify shortfalls in MWD support capabilities to allow timely realignment of operational requirements.

2. Without a uniform and consistent method of determining the MWD section operating status, commanders could easily misinterpret the current situation. Relying solely on conventional standards of personnel and equipment, on-hand status reporting does not necessarily apply in the MWD environment since the human/dog team must first be matched and trained to result in a usable and reliable capability. Section 5100 provides a criterion, based on several key factors, to define the individual MWD team readiness to support activities at any point in time. Due to the practice of assigning multiple MWDs to an individual handler in times of personnel shortages, the number of assigned teams is not a true gauge of the MWD section capability.

3. The Marine Corps MWD section mission makes it necessary to utilize unique reporting standards for the Supporting Establishment and LE Bn sections. Supporting Establishment sections have a daily requirement to provide law enforcement in a defined local area [HMX-1 MWD section is included in this group]. The LE Bn sections must be prepared to respond to an ever changing global threat with a broader range of MWD capabilities requiring more extensive personnel training and MWD team development.

8303. Operating Status Criteria

1. Table 8-10A [Supporting Establishment] and 8-10B [LE Bn] provide the criteria and definition for reporting three MWD

section operating status categories. The operating status will be computed in WDMS and reflected on the KM and Command Status dashboards. Also, the section operating status will be included on program management status reports.

**NOTE:** Version A of this manual introduces table 8-10B, but the associated WDMS programming change will not be in place until approximately 2020. The intent of this early release of this new table is to enable MEF MWD sections to implement procedures and internal manual reporting processes to reflect at least LIMITED operational status as defined in table 8-10B. Until WDMS is updated, MEF sections should be showing at least a MARGINAL status of 30% operating status in WDMS.

2. Although very broad in nature, the use of the section operating status reporting will provide MWD command and management personnel at all levels with an effective means of interpreting the ability of the section to respond to operational commitments.

24 FEB 2020

Table 8-10A.--USMC MWD Section Operating Status Criteria-Supporting Establishment		
Operating Status Category (Color Code)	Definition	Criteria NOTES:(1)(2)(3) Apply
<b>Operational (Green)</b>	Mission capable to support majority of organizational requirements.	At least <b>80%</b> of all Authorized Teams are <u>effectively</u> - <ul style="list-style-type: none"> <li>• Ready,</li> <li>• Restricted-1,</li> <li>• Restricted-2,</li> <li>• Restricted-3,</li> <li>• Restricted-4 or</li> <li>• Deployed</li> </ul>
<b>Limited (Yellow)</b>	Mission capable but can only support limited number of organizational requirements.	<b>79% to 60%</b> of all Authorized Teams are <u>effectively</u> - <ul style="list-style-type: none"> <li>• Ready,</li> <li>• Restricted-1,</li> <li>• Restricted-2,</li> <li>• Restricted-3,</li> <li>• Restricted-4 or</li> <li>• Deployed</li> </ul>
<b>Marginal (Red)</b>	Mission capability so limited to the extent that support role is severely impacted.	None of the Above
<b>NOTES:</b> (1) The number of authorized teams is the same as the authorized MWDs specified in the unit T/E. (2) A handler can be teamed and qualified with multiple MWDs; consequently, the number of " <b>EFFECTIVE</b> " teams cannot exceed the number of handlers actually assigned to those teams that have a readiness category of <b>READY, RESTRICTED 1 thru 4, or DEPLOYED</b> . (3) Deployed teams are considered READY even when the qualification is expired in WDMS.		

24 FEB 2020

Table 8-10B.--USMC MWD Section Operating Status Criteria- Law Enforcement Battalion (LE Bn), MEF		
Operating Status Category (Color Code)	Definition	Criteria NOTES:(1)(2)(3)(4) Apply
<b>Operational (Green)</b>	Mission capable to support majority of organizational requirements.	1. At least <b>45%</b> of all Authorized Teams are <u>effectively</u> - <ul style="list-style-type: none"> <li>• Ready,</li> <li>• Restricted-1,</li> <li>• Restricted-2,</li> <li>• Restricted-3,</li> <li>• Restricted-4 or</li> <li>• Deployed</li> </ul> <u>AND</u> 2. <u>Each</u> MWD capability has at least <b>40%</b> authorized teams that meet the criteria in #1.
<b>Limited (Yellow)</b>	Mission capable but can only support limited number of organizational requirements.	1. At least <b>33%</b> of all Authorized Teams are <u>effectively</u> - <ul style="list-style-type: none"> <li>• Ready,</li> <li>• Restricted-1,</li> <li>• Restricted-2,</li> <li>• Restricted-3,</li> <li>• Restricted-4 or</li> <li>• Deployed</li> </ul> <u>AND</u> 2. <u>Each</u> MWD capability has at least <b>33%</b> authorized teams that meet the criteria in #1.
<b>Marginal (Red)</b>	Mission capability so limited to the extent that support role is severely impacted.	None of the Above
<b>NOTES:</b> (1) The number of authorized teams is the same as the authorized MWDs specified in the unit T/E. (2) A handler can be teamed and qualified with multiple MWDs; consequently, the number of " <b>EFFECTIVE</b> " teams cannot exceed the number of handlers actually assigned to those teams that have a readiness category of <b>READY, RESTRICTED 1 thru 4, or DEPLOYED</b> . (3) Deployed teams are considered <b>READY</b> even when the qualification is expired in WDMS. (4) Current MWD capabilities in MEF sections: <b>CTD, PDDD, PEDD, SSD</b> .		



8304. Operating Status Examples

1. Supporting Establishment (SE). Figures 8-11 thru 13 illustrate the operating status computation for three SE MWD section scenarios with varying situations relating to the on-hand MWDs and personnel and team qualification. Scenario 1 reflects the ideal situation when the section has a complete compliment of MWDs, personnel, and qualified teams. Scenario 2 shows the situation when the section is low in personnel compared to the number of MWDs, and every person in the section is assigned to an MWD. Scenario 3 demonstrates an unfavorable situation where the section has relatively high personnel and MWD status, but the handlers have not been assigned to teams nor are the existing teams qualified.

a. Scenario 1 (Operational). Figure 8-11 reflects a section that is operating at a high level of readiness.

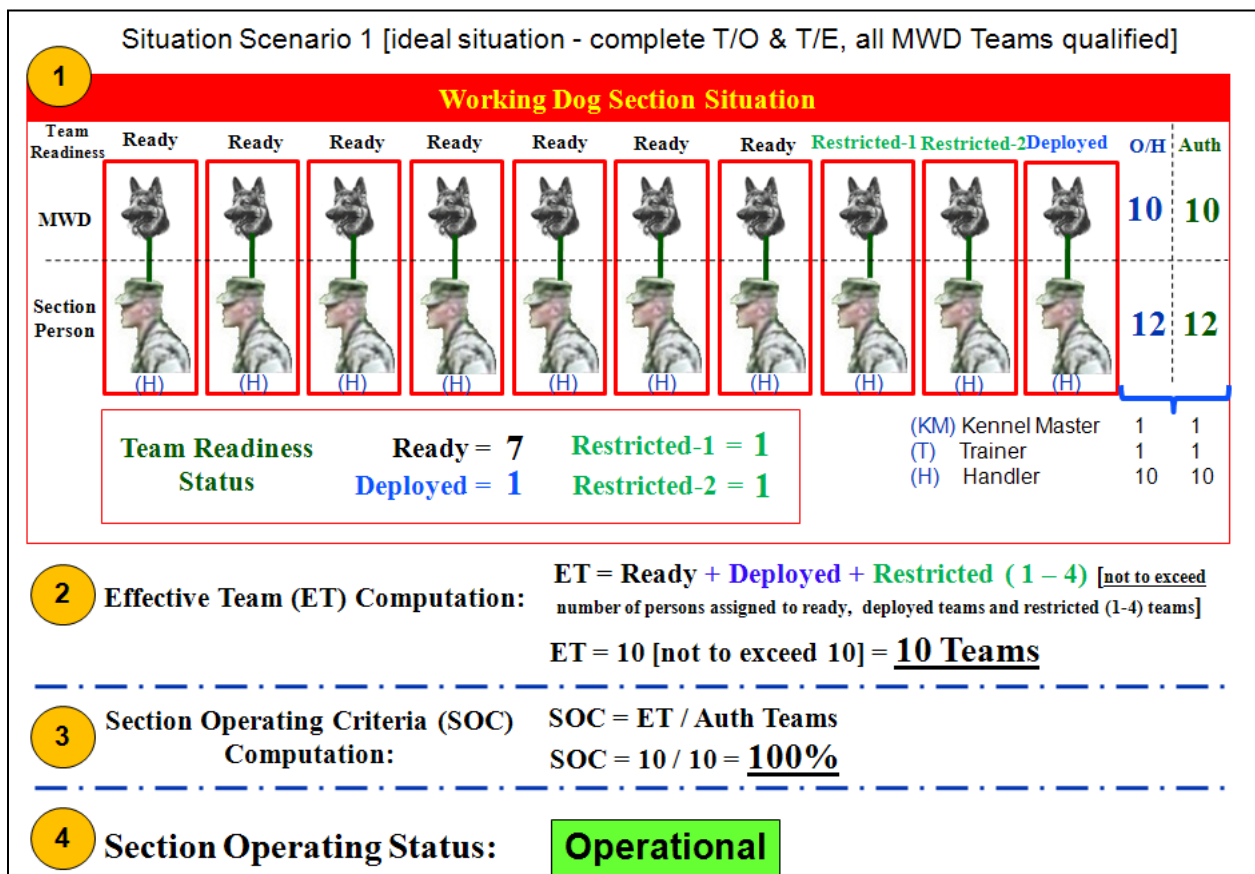

Figure 8-11.--Example of SE Section Operating Status - Scenario 1 [Operational]

b. Scenario 2 (Limited). Figure 8-12 depicts a situation where the number of MWDs in qualified teams could mislead the chain-of-command about the section support capability if multiple handler assignments were not taken into consideration. In this case, having seven ready teams, one deployed team, and 89% of the MWDs showing as qualified teams gives the impression that the section should be at a high level of operational status [80%=8/10]; in reality, the section can only field six teams for a 60% operational status.

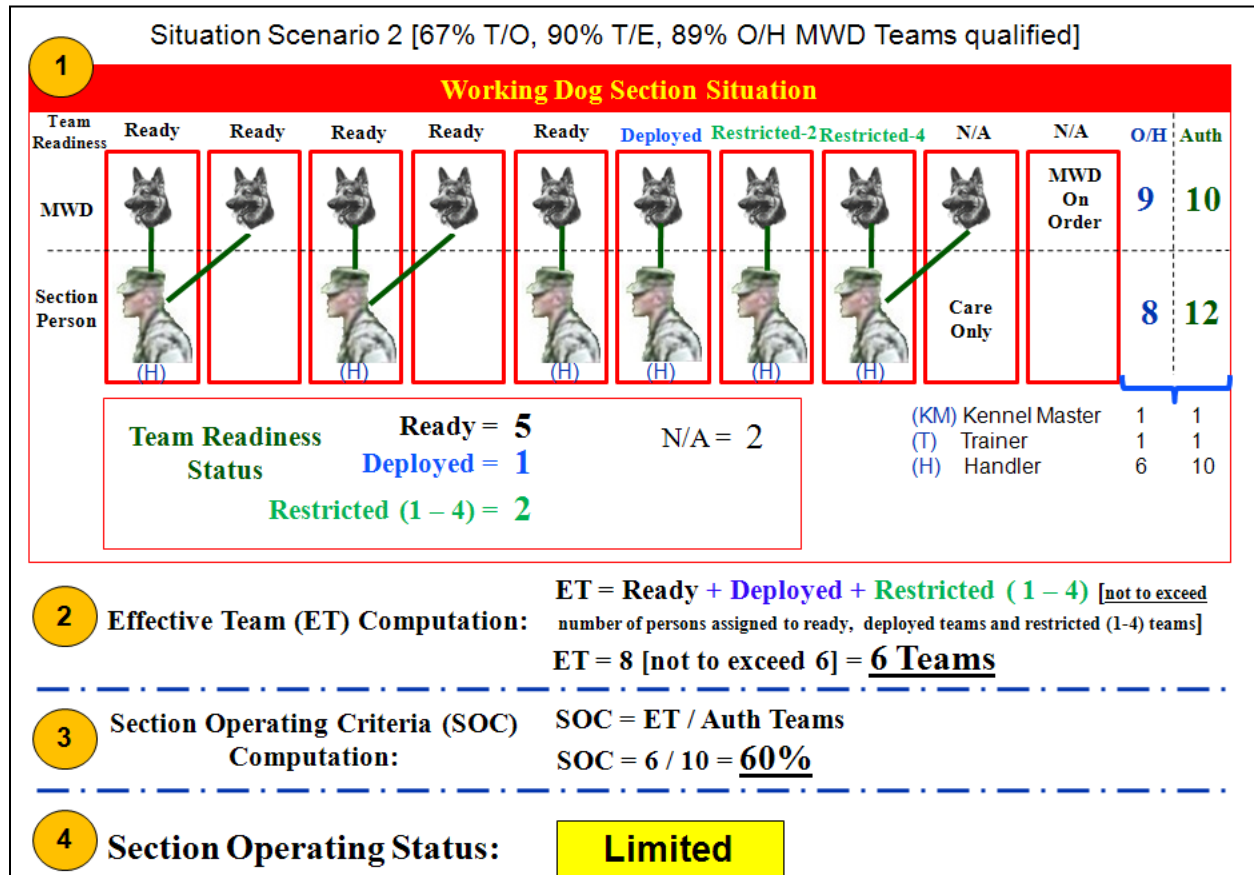

Figure 8-12.--Example of SE Section Operating Status - Scenario 2 [Limited]

c. Scenario 3 (Marginal). Figure 8-13 depicts a marginal readiness status which has been caused by a combination of significant personnel turnover, MWD condition issues, and lack of updated WDMS records. This situation should be closely monitored to ensure timely corrective actions are taken to improve the section operating status.

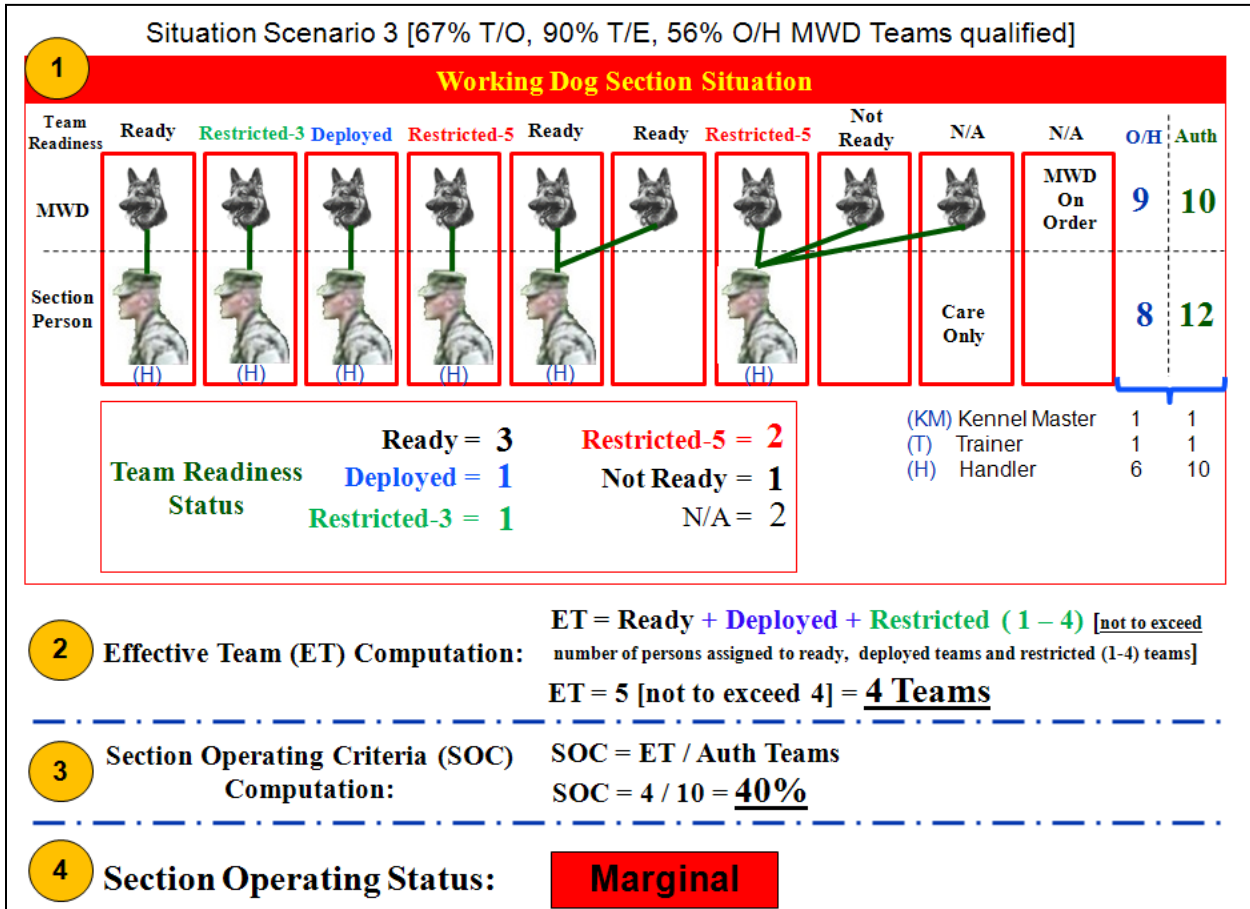

Figure 8-13.--Example of SE Section Operating Status - Scenario 3 [Marginal]

2. Law Enforcement (LE) Battalion (Bn). Figure 8-14 illustrates the operating status computation for three different MEF MWD section scenarios. The same logic for the section operating criteria (SOC), as applied in figures 8-11 thru 8-13, is used to compute the section total and capability SOC's.

<b>LE Bn. Operating Status Scenarios</b>				
	<b>Scenario #1</b>	<b>Scenario #2</b>	<b>Scenario #3</b>	
<b>MWD Capability</b>	<b>CTD</b> T/E = 6	ET = 3	ET = 2	ET = 1
		SOC = 50%	SOC = 33%	SOC = 17%
	<b>PDDD</b> T/E = 3	ET = 2	ET = 1	ET = 0
		SOC = 67%	SOC = 33%	SOC = 0%
	<b>PEDD</b> T/E = 18	ET = 8	ET = 6	ET = 6
		SOC = 44%	SOC = 33%	SOC = 33%
	<b>SSD</b> T/E = 18	ET = 9	ET = 6	ET = 4
		SOC = 50%	SOC = 33%	SOC = 22%
	All T/E = 45	ET = 22	ET = 15	ET = 11
		SOC = <b>49%</b>	SOC = <b>33%</b>	SOC = <b>24%</b>
	<b>Situation</b>	1 Squad deployed 1 Squad in prep 1 Squad down	Reduced deploy All capabilities up	Reduced man level Few deployed Missing capability
	<b>Operating Status</b>	<b>Operational</b>	<b>Limited</b>	<b>Marginal</b>
<p><u>Definitions:</u> See Figures 8-11 thru 13 for use of the following terms.  <b>ET</b> = Effective Teams  <b>SOC</b> = Section Operating Criteria  <b>T/E</b> = Table of Equipment [NOTE: Data used in this figure represent the authorization at the time of publication.]</p>				

Figure 8-14.--Examples of MEF Section Operating Status

8305. Limitations. Command and management personnel should be aware that the status reporting is limited in providing an accurate operating picture in the following situations:

1. Units Not at Full Operational Capability (FOC). During the buildup of a new MWD section to FOC, the status rating will not be an effective measurement until the unit receives at least 40% of authorized levels of both MWDs and personnel.

2. Limited Military Working Dog (MWD) Capability. The MWD team capability is not a factor in the operating status computation; therefore, not having a specific capability [e.g., drug detection] in an operational section may have a significant impact on supporting command commitments.

3. High Percentage of Deployed Military Working Dog (MWD) Teams. A high percentage of deployed MWD teams does not have a negative impact on the MWD section operational status as it is computed in figure 8-14. In reality, an MWD section with an "operational" status may have only a limited or marginal capability to respond to local requirements [in the case of an installation] or unforeseen operational commitments [in the case of a LE Bn] if there are few MWD teams left at the base.

8306. Acceptable Section Operating Status

1. Introduction. The MWD community leadership, from KM to the MWD PM, has a responsibility to be aware of MWD section operating status and establish procedures to monitor the situation and to focus resources where required to correct deficiencies. Leadership users of WDMS will have access to reports, like the example shown in figure 8-15, which will provide the information necessary to effectively monitor the trends of the MWD section operating status over a 12-week period.

USMC MWD ORGANIZATION	USMC MWD SECTION OPERATING STATUS HISTORY (weeks)											
	Last Eff Date	-1	-2	-3	-4	-5	-6	-7	-8	-9	-10	-11
	28-Apr-09	21-Apr-09	14-Apr-09	7-Apr-09	31-Mar-09	24-Mar-09	17-Mar-09	10-Mar-09	3-Mar-09	24-Feb-09	17-Feb-09	10-Feb-09
7. BASE OPERATIONS [PMO]												
Section - EXAMPLE	35%	40%	40%	60%	65%	75%	75%	85%	75%	80%	75%	85%

Figure 8-15.--Example of Section Operating Status Trend Report

2. Acceptable Section Performance

a. The section operating status must consistently be maintained at the guideline objective as stated in paragraph 7003.3 [Limited or better]. Realistically, an MWD section will move between operational and limited status on any given week,

24 FEB 2020

depending on personnel turnover, illness, and other duty assignments.

b. Unexpected changes in personnel and MWD status will occasionally result in "Marginal" operating status.

c. Monitoring the trend of historic operating status is important in that it will identify if institutional corrections are in place for improving the operating status. Even more important, the KM must constantly be documenting projected manpower and MWD changes that will significantly impact future operating status.

8307. Corrective Action. KMs will ensure MWD section personnel, MWD, and qualification information is maintained within WDMS per paragraph 8105. The following paragraphs discuss the roles of both operational leadership and the MWD PM.

1. Command

a. The KM and operational leadership should monitor the MWD section operating status on a weekly basis, preferably after the weekly activity reporting deadline (see paragraph 8104.2.a). The ongoing operating status trend is significant so commands are encouraged to use the following guidelines when considering corrective action:

(1) Priority 1. **Marginal** status reported consistently for over two report dates.

(2) Priority 2. **Limited** status reported consistently for over five report dates.

b. Corrective action at the MWD section/command can include:

(1) Review reported authorized MWD and personnel levels in WDMS to ensure they are consistent with official command records and TFSMS.

(2) Review reported MWD and handler availability status information for accuracy.

(3) Submit written requests via email for priority assignment of inbound personnel to higher command.

(4) Prioritize scheduling of MWD team training with the objective of successfully completing required validations.

(5) Submit WDMS help tickets to request assistance in correcting any programmatic issues that may negatively impact the reporting of the MWD section operating status.

(6) Submit requests to the MWD PM [see Appendix C] for support that would result in improvement of the MWD section operating status (i.e., personnel training in use of WDMS, assist in completing validations, MWD training issues, reassignment of MWD or handler assets from other Marine Corps organizations, and priority shipment of assets from MWD and handler school seat assignments).

2. Military Working Dog (MWD) Program Manager

a. The MWD PM will monitor the MWD section operating status at least on a semi-monthly basis, after the weekly activity recording deadline (see paragraph 8104.2.a). The primary focus of program level attention will be those MWD sections which have the following reporting trends:

(1) Priority 1. **Marginal** status reported consistently for over five report dates.

(2) Priority 2. **Limited** status reported consistently for over eight report dates.

b. Corrective action by the MWD PM will include:

(1) Raise the response priority on WDMS help tickets that request assistance in correcting any programmatic issues which have a negative impact on the reporting of the MWD section operating status.

(2) Respond to command requests for assistance to provide support that would improve the MWD section operating status.

(3) Where none of the above requests have been received, the MWD PM will initiate an official inquiry, via the chain-of-command, to coordinate appropriate action that will result in an improved MWD section operating status.

Veterinarian Letterhead

EXAMPLE

(Date)

MEMORANDUM FOR THE RECORD

SUBJECT: CERTIFICATE OF ACCLIMATION/FITNESS FOR TRAVEL

1. This certificate of acclimation/fitness for travel applies to the below listed animal for shipment by military and commercial airline traffic or for interstate transport by rail or road transport.

Military Working Dog Name \_\_\_\_\_

Brand \_\_\_\_\_

2. The undersigned hereby certifies that the animal in this shipment appears healthy for transport, and unless otherwise noted, must be maintained at a temperature within the animal's thermoneutral zone, as defined in Title 9, Code of Federal Regulations.

Acclimation/thermoneutral zone for this animal is (Check One):

- Regulation IAW 9 CFR (45°-85° F) or  
 As listed from \_\_\_\_\_ ° F to \_\_\_\_\_ ° F.

\_\_\_\_\_  
(Signature and Signature Block of  
Certifying Veterinarian)

Figure 8-1.--Example Certificate of Acclimation/Fitness for Travel MFR



**EXAMPLES OF MWD TEAM ACTIVITY RECORDING**  
**IMPORTANT**

- MWD Team activity time shall not be duplicated among or within the WDMS skill data entry features for Basic Skills, Patrol, Detection, or Tracking.
- It is the handler's responsibility to reasonably estimate and allocate time among the reporting categories.
- General Guidelines (See table 8-3 for details):
  - MWD activity time recorded in WDMS represents the time that that MWD is out of the kennel facility for purposes of qualification, utilization or in-transit.
  - Daily break time nor time the MWD is in a transport trailer awaiting local movement or a TVC event is not recorded in WDMS.
  - Demonstrations are recorded as training.
- WDMS entry screens restricts Util/Qual recording by the following types of events: [events highlighted in **red** must be rated by handler when time is recorded]

Event	Qualification (TVC)	Utilization
<b>Basic Skills</b>		
<b>Obedience (On-Leash)</b>	X	
<b>Obedience (Off-Leash)</b>	X	
<b>Obstacle Course</b>	X	
<b>Gunfire</b>	X	
<b>Physical Conditioning</b>	X	
Demonstration	X	
MWD In Transit	X	
Vehicle Patrol		X
Walking Patrol		X
Static Post		X
<b>Patrol</b>		
<b>Controlled Aggression</b>	X	X
<b>Intruder Detection</b>	X	X
Security Escort		X
<b>Detection</b>	X	X
<b>Tracking</b>	X	X

See table 8-3--MWD Activity Recording Guide for the supporting guidance used in preparing the following examples.

Figure 8-2.--Examples of Activity Recording (1 of 4) Scenarios

**I. ALL MWDs**

**Example 1: PEDD/PDDD Scenario [Training Day]**

MWD Time Out of Kennel	Skill Allocation (Minutes)					
	Basic Skills		Patrol		Detection	
	Qual	Util	Qual	Util	Qual	Util
"MWD in Transit" -To/From Training Area - 20 min.	20					
Obstacle course training - 10 min.	10					
Aggression training - 30 min.			30			
Patrol validation events - 60 min. [building search and a scent scout]			60			
<b>TOTAL [MIN]</b>	30		90			
<b>TOTAL BY SKILL [MIN]</b>	30		90			
<b>TOTAL FOR DAY [HR:MIN]</b>	<b>2:00</b>					

**II. SUPPORTING ESTABLISHMENT**

**Example 2: PEDD/PDDD Scenario [Base Operations]**

MWD Time Out of Kennel	Skill Allocation (Minutes)					
	Basic Skills		Patrol		Detection	
	Qual	Util	Qual	Util	Qual	Util
Vehicle Patrol -To/From post - 1 hr.		60				
Static Post conducting main gate RAM: - 45 vehicles searched [incl. 2 drop aid events]- 90 min. [SEE NOTE] - Standing ready in gate area - 1 hr.		60				90
Vehicle patrol - 2 hr.		120				
Walking patrol in warehouse area [incl. intruder building search (15 min.)] - Total 1 hr.		45		15		
Physical fitness run - 30 min.	30					
<b>TOTAL [MIN]</b>	30	285		15		90
<b>TOTAL BY SKILL [MIN]</b>	315		15		90	
<b>TOTAL FOR DAY [HR:MIN]</b>	<b>7:00</b>					
<b>NOTE:</b> Drop aid training in the duty area is utilization time.						

Figure 8-2.--Examples of Activity Recording (2 of 4) Scenarios

**Example 3: PEDD Scenario [Movement to Non-Operational Mission]**

MWD Time Out of Kennel	Skill Allocation (Minutes)	
	Basic Skills	
	Qual	Util
"MWD in Transit" -Load MWD and equipment into vehicle - 1 hr.	60	
"MWD in Transit" -To Airport (incl. MWD loading, standby for flight) - 3 hr.	180	
"MWD in Transit" -Flight to destination airport - 2 hr.	120	
"MWD in Transit" -Airport activities [pickup MWD, baggage, embark] - 1.5 hr.	90	
"MWD in Transit" -Transport to lodging and settle MWD into room - 45 min.	45	
Handler attend briefing and MWD on standby status - 2 hr. [SEE NOTE]	0	
Physical fitness run w/ MWD - 30 min.	30	
<b>TOTAL [MIN]</b>	<b>525</b>	
<b>TOTAL BY SKILL [MIN]</b>	<b>525</b>	
<b>TOTAL FOR DAY [HR:MIN]</b>	<b>8:45</b>	
<b>NOTES:</b>		
<ul style="list-style-type: none"> <li>• MWD activity recording ends on arrival at lodging facility and MWD is contained in temporary kenneling - even when the MWD team is on standby status.</li> <li>• Consolidate "MWD in Transit" entry for day as 8 hours, 15 minutes.</li> </ul>		

**III. OPERATING FORCE**

**Example 4: All MWDs Scenario [Movement to Combat Ops]**

MWD Time Out of Kennel	Skill Allocation (Minutes)	
	Basic Skills	
	Qual	Util
<b>Day #1 -</b>		
"MWD in Transit" -Load MWD and equipment into vehicle - 2 hr.	120	
"MWD in Transit" -Drive to Airport, arrange MWD loading, standby for flight - 3 hr.	180	
"MWD in Transit" -Flight outbound OCONUS - 12 hrs [rest of day #1 to midnight]	720	
<b>Day #2</b>		
"MWD in Transit" -Air travel continues to destination airport - 12 hr.	720	
"MWD in Transit" -Airport activities, travel to assembly area and kennel MWD - 6 hr.	360	
<b>TOTAL DAY #1 [MIN]</b>	<b>1020</b>	
<b>TOTAL FOR DAY #1 [HR:MIN]</b>	<b>17:00</b>	
<b>TOTAL DAY #2 [MIN]</b>	<b>1080</b>	
<b>TOTAL FOR DAY #2 [HR:MIN]</b>	<b>18:00</b>	
<b>NOTE:</b> Consolidate "MWD in Transit" entries: Day#1 = 17 hr., Day#2 = 18 hr.		

Figure 8-2.--Examples of Activity Recording (3 of 4) Scenarios

24 FEB 2020

**Example 5: PEDD Scenario [Combat Ops]**

MWD Time Out of Kennel	Skill Allocation (Minutes)					
	Basic Skills		Detection		Patrol	
	Qual	Util	Qual	Util	Qual	Util
Mounted (Vehicle) patrol - 1 hr.		60				
Support road clearing patrol: - 4 route clearing searches - 2 hr. - Execute all obedience commands during break - 30 min. - Conducting vehicle patrol in area of operations - 4.5 hr.	30			120		
Physical fitness run - 30 min.	30					
<b>TOTAL [MIN]</b>	60	330		120		
<b>TOTAL BY SKILL [MIN]</b>	390		120			
<b>TOTAL FOR DAY [HR:MIN]</b>	<b>8:30</b>					

**Example 6: SSD Scenario [Combat Ops]**

MWD Time Out of Kennel	Skill Allocation (Minutes)					
	Basic Skills		Detection		Patrol	
	Qual	Util	Qual	Util	Qual	Util
Vehicle patrol - 4 hr.		240				
"MWD in Transit" -To/From Training Area - 15 min.	15					
Obstacle course training - 10 min.	10					
Gunfire training - 10 min.	10					
Basic Skills validation events - 30 min.	30					
2 Detection validation events - 60 min. [building, vehicle]			60			
<b>TOTAL [MIN]</b>	65	240	60			
<b>TOTAL BY SKILL [MIN]</b>	305		60			
<b>TOTAL FOR DAY [HR:MIN]</b>	<b>6:05</b>					

**Example 7: CTD Scenario [Combat Ops]**

MWD Time Out of Kennel	Skill Allocation (Minutes)					
	Basic Skills		Tracking		Patrol	
	Qual	Util	Qual	Util	Qual	Util
Mounted (Vehicle) patrol - 1 hr.		60				
Support road clearing patrol: - 3 tracks conducted for suspected IED planters - 2 hr. - Execute all obedience commands during break - 30 min. - Conducting walking patrol along route - 4.5 hr.	30			120		
Physical fitness run - 30 min.	30					
<b>TOTAL [MIN]</b>	60	330		120		
<b>TOTAL BY SKILL [MIN]</b>	390		120			
<b>TOTAL FOR DAY [HR:MIN]</b>	<b>8:30</b>					

Figure 8-2.--Examples of Activity Recording (4 of 4) Scenarios



[COMMAND LETTER HEAD]

EXAMPLE

From: Kennel Master [Rank, FN, MI, Last Name]

To: Name, Rank, Title, Organization (Demonstration Witnessing Officer for the last Certification)

Subj: MILITARY WORKING DOG TEAM (MWD) CERTIFICATION, [Drug/Explosive],  
REVOKE OF -

[Handler Rank, Name] / [MWD Name, Brand / Capability]

Ref: (a) USMC MWD Manual [MCO ID]

1. In accordance with Reference (a), the detection certification for the subject MWD Team is hereby revoked effective [ddmmyyyy] for the following reason(s):

- [state one or more of the reasons for revoking a certification as listed in Chapter 6 of the reference]

2. [Briefly describe the corrective action being taken and estimated date the team will be certified (if applicable) or the date when the MWD will be transferred or removed from service [adoption or euthanasia].

3. With the loss of the subject MWD Team from operational service, this command has [number] of [Drug/Explosive] MWD Teams certified to conduct probable cause searches on this installation.

4. Point of Contact is [KM Rank, Name], [Office phone number / DSN]

\_\_\_\_\_  
Signature (Kennel Master)

Copy to: [As required by command procedures]

Figure 8-4.--Example Team Certification Revoke Letter



[COMMAND LETTER HEAD]

EXAMPLE

From: Kennel Master [Rank, FN, MI, Last Name]  
To: Commanding Officer, [Organization, Base]  
Subj: NON-AVAILABILITY OF TRAINING AID ODOR, [name of training aid odor, NSN  
(if applicable)], NOTIFICATION OF  
Ref: (a) USMC MWD Manual [MCO ID]

1. In accordance with Reference (a), this notification is initiated to inform you that the subject training aid odor(s) is not available for training purposes by this MWD section.
2. [Briefly describe the reason the training aid is no longer available and the corrective action that is being taken, if applicable. Include a projected date when the aid would be available and teams being qualified again].
3. The following MWD Team(s) with current certifications should not be considered reliable, in accordance with reference (a), to detect [name of Drug/Explosive] after the date indicated:

<u>MWD Name</u>	<u>MWD Brand</u>	<u>Handler Rank/Name</u>	<u>Last Date Qualified on Odor [name] (35 calendar days from last exposure)</u>
-----------------	------------------	--------------------------	---

[List impacted MWD teams in section with current certifications]

4. Point of Contact is [KM Rank, Name], [Office phone number/DSN]

\_\_\_\_\_  
Signature (Kennel Master)

Copy to: [Name, Rank, Title, Organization  
(Demonstration Witnessing Officer for the last Certification)]

Figure 8-5.--Example Training Aid Non-Availability Letter



[COMMAND LETTER HEAD]

EXAMPLE

[DATE]

MEMORANDUM FOR THE RECORD

From: Kennel Master [Rank, FN, MI, Last Name]

Subj: VALIDATION GRACE PERIOD, GRANTING OF

Ref: (a) USMC MWD Manual [MCO ID]

1. In accordance with Reference (a), this memorandum records that as Kennel Master for the MWD section at [organization, base], I do hereby grant a grace period on the following validation(s) for the MWD team [Handler Rank/Name / MWD Name/ Brand / Capability]:

Validation Type	Published End Date	Granted New End Date (Team Return Date + 30 Days)
Basic Skills	ddmmyyyy	ddmmyyyy
Patrol	ddmmyyyy	ddmmyyyy
Detection [Drug/Explosive]	ddmmyyyy	ddmmyyyy

[List only those validations that expired while the team was TAD]

2. This action was deemed necessary to continue effective MWD support to this command since this team was TAD on a mission for the period [ddmmyyyy to ddmmyyyy] during which validation events could not be conducted.

3. Point of Contact is [KM Rank, Name], [Office phone number/DSN]

\_\_\_\_\_  
Signature (Kennel Master)

Copy to: Handler identified above [Name, Rank, Title]  
MWD Service Record Folder

Figure 8-6.--Example Team Validation Grace Period MFR



[COMMAND LETTER HEAD]

EXAMPLE

[DATE]

From: Kennel Master [Rank, FN, MI, Last Name]

To: [Name, Rank, Title, Organization (Demonstration Witnessing Officer)]

Subj: CERTIFICATION GRACE PERIOD, REQUEST FOR

Ref: (a) USMC MWD Manual [MCO ID]

1. In accordance with Reference (a), the granting of a grace period is hereby requested on the detection certification for the MWD team [Handler Rank / Name / MWD Name/Brand / Capability].
2. The grace period until [ddmmyyyy (return date plus 30 calendar days)] allows this MWD team to support probable cause searches. By the end of this period, the MWD will be exposed to all available odors as specified on the current team certification report.
3. This action was deemed necessary to continue effective MWD support to this command since this team was TAD on a [mission / deployment] for the period [ddmmyyyy to ddmmyyyy] during which detection training on all odors could not be conducted in the past 35 consecutive days.
4. Point of Contact is [KM Rank, Name], [Office phone number], DSN [number].

\_\_\_\_\_  
Signature (Kennel Master)

By Dir [If KM not available]

Copy to: [Name, Rank, Title, Organization (Handler identified above)]

Endorsement:

To: Kennel Master

From: [Name, Rank, Title, Organization (Demonstration Witnessing Officer)]

Grace period is:  APPROVED  DISAPPROVED

Comments:

\_\_\_\_\_  
\_\_\_\_\_

Date: \_\_\_\_\_

\_\_\_\_\_  
Signature (Demonstration Witnessing Officer)

Figure 8-7.--Example Team Certification Grace Period Letter



Chapter 9

Military Working Dog (MWD) Kenneling And Support Equipment

Section 9000 - Kenneling Requirements

9001. Purpose. This section provides an overview of the requirements and policy associated with the primary types of kenneling necessary to maintain MWD assets in garrison and deployment environments.

9002. Introduction. Where ever MWD assets are utilized, suitable kenneling must be provided to ensure the safety and health of the animal. Temporary kennels may be used in the interim until permanent facilities can be completed. Permanent or possibly temporary kennels may apply in areas of operation (AO) where MWD teams will be deployed for extended periods and will be rotated on a regular cycle. Transport kennels will be utilized for the MWD movement. Field kennels provide temporary shelter through expedient means in forward operating areas. The below desired requirements apply for these varying degrees of kenneling.

9003. Permanent Kennel

1. Definition. At installations with established long-term MWD sustainment, permanent kennel construction and periodic renovation is necessary to effectively meet operational requirements. Permanent kenneling is incorporated into a self-contained kennel facility that includes all the construction features required for daily MWD care and training.

2. Planning Guide. Appendix K is a design guide for planning the construction or renovation of a DoD MWD permanent kennel facility and site. The kennel planning factor is 145 square feet per MWD, which includes kitchen, tack room, and a kennel area.

3. Construction and Approval. Once the need and the justification for a new or renovated permanent kennel facility is established, the Commanding Officer or PM/PC initiates a request through the base Resident Officer-in-Charge of Construction (ROICC) or equivalent to develop the kennel

facility as designed. The following personnel should be involved in the planning process:

- MWD PM (see Appendix C)
- Base/Station VCO
- Physical Security Specialist
- Base/Station Safety Personnel
- Kennel Master [must be consulted to ensure that the minimum requirements (see Appendix K) are included in the final stage.

4. Funding. Kennel construction is identified by the following two categories based on the funding requirement as specified in the DD 1391, FY Military Construction Project Data:

a. Major [Construction costs exceed \$750K]. The MWD PM should be notified of the project DD 1391 identification number so that the program office can make liaison with the DoD military construction (MILCON) agency to monitor project status, review drawings and assist in resolving issues as required.

b. Minor [Construction costs under \$750K]. The MWD PM should be provided with the project DD 1391 for assistance in obtaining program funding and/or assistance in expediting the request through the MILCON process.

9004. Temporary Kennel

1. Definition. A temporary kennel is one that can be constructed on site for mid-term use at sites with pending status for possible relocation or permanent status. These kennels are normally provided as a kit consisting of a dog house attached to a covered run area and ranging in complexity from heavy-duty construction to lightweight one-man transportable configurations [see figure 9-1 for three examples].

2. Guidelines. The following temporary kenneling guidelines apply:

a. Individual dog stall (dog runs) that is 24 to 36 square feet.

b. Access door [6 feet high-preferred] into dog run.

- c. Sealed concrete or assembled durable sectional flooring for health reasons and ease of cleaning.
- d. Kennel floor drains into collecting trough
- e. Kennel walls constructed with woven mesh wire fencing (with enclosed ends to prevent exposed sharp edges).
- f. Each kennel separated with an isolation barrier.
- g. Top barrier to prevent MWDs from climbing or jumping out.
- h. Shade cover constructed of material or rigid material.
- i. A dog house is attached to exterior of dog run area. At a minimum, the house can be a transport kennel [or equivalent] that meets the interior dimension requirements for the MWD size (see paragraph 9005).
- j. Additional environmental control features may be required in operational theaters that experience extreme temperatures.
- k. Site selection shall enable continuous monitoring by personnel who are able to care for and protect the MWDs.



Figure 9-1.--Example Temporary Kennels

9005. Transport Kennel

1. Definition. Table 9-1 provides a formula for determining the measurements necessary for selecting/constructing the appropriate sized container to transport a specific MWD. There

are several types of commercially available transport kennels made of metal and composite materials.

2. Design. Considerations are:

- a. Durable construction to secure MWD.
- b. Floor will retain liquids [does not leak/drain while in transit].
- c. MWD lays on raised panel above liquids.
- d. Access to provide water.
- e. Sufficient ventilation.
- f. Access door secures with fastener.
- g. Spacer bars provided along the middle of both long sides of the container.
- h. Contact the airline for additional considerations that may apply per their live animal regulations.

3. Markings. All transport kennels shall be marked [label or stencil] as specified below:

- a. On at least two opposite sides with [3/4" letters] [black or red] -

**"Caution - Military Working Dog"**

- b. On all four sides with "This Way Up" and green "Live Animal" per commercial carrier standards (see figure 9-2 for examples).

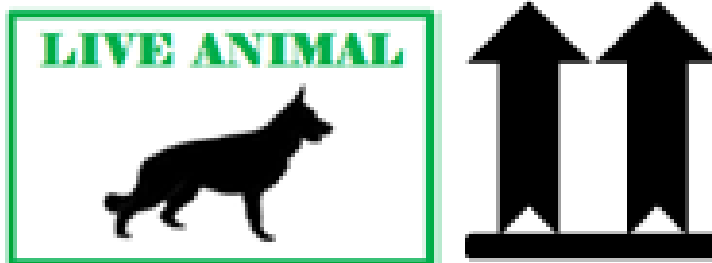

Figure 9-2.--Example Kennel Markings for Live Animal and This Way Up

<b>Table 9-1.--MWD Transport Kennel Measurement Formula</b>	
<b>Formula</b>	<b>Formula Description</b>
A = D = ½ E B = 2 x F C = G	A = inside length of the container B = inside width of the cage C = inside height of the cage D = dog's length from its nose to the root of its tail E = dog's height from the ground to its elbow joint F = dog's shoulder width G = dog's height in standing position
40"L X 27"W X 30"H - Extra-large size is the most common size which can accommodate the majority of MWDs for shipment.	

9006. Field Expedient Kennel

1. Definition. During the initial stages of deployment or when participating in extended outward operations, the handler will be challenged to maintain the team effectiveness by sheltering the MWD from the elements and conducting training when permanent or temporary kenneling is not readily available.

2. Considerations. Normally, the handler sleeps near where the MWD is kenneled to ensure security and to quickly respond to an animal care emergency. It is not recommended that MWDs live in the same quarters with the handlers. Figures 9-3 and 9-4 illustrate various examples of field expedient shelters that can be constructed with locally available materials.

**CAUTION:**

1. Align the shelter so the MWD will have sufficient shaded area during the entire rest period.
2. Keep water in shade since MWDs will not drink hot water.

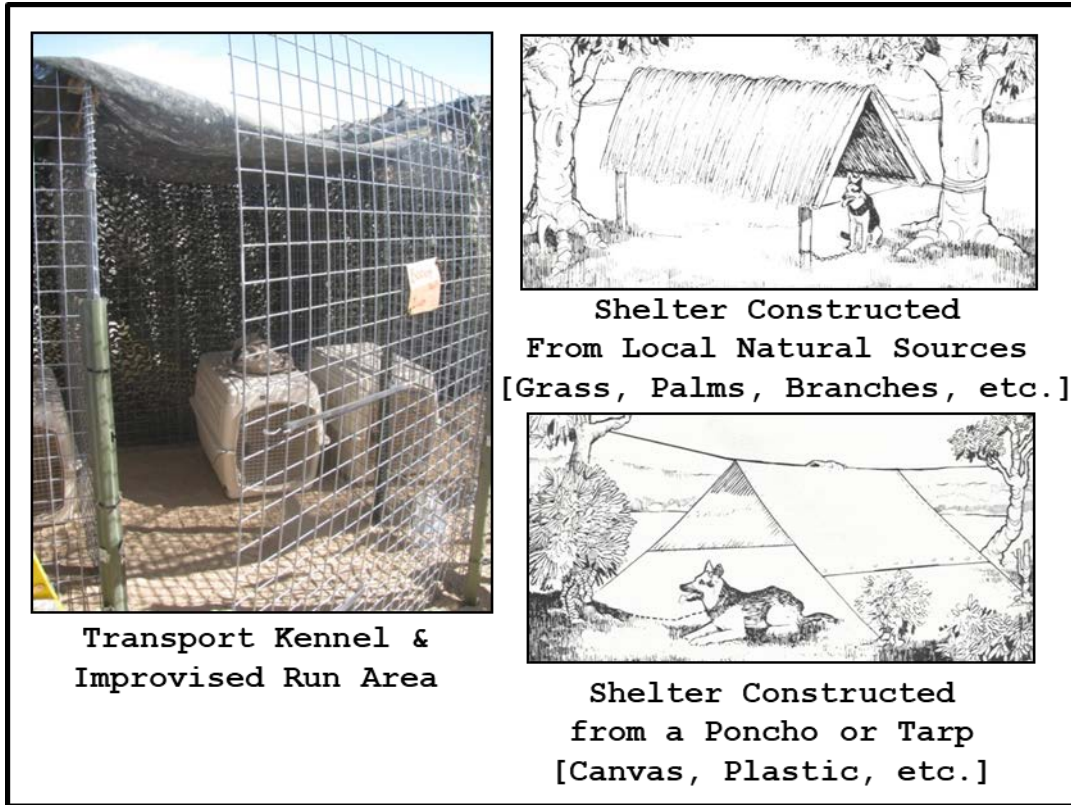
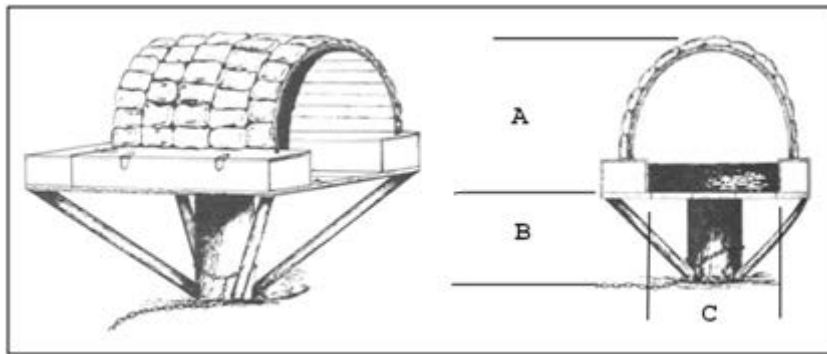

Figure 9-3.--Example Field Expedient Shelters



Suggested Dimensions

A [head space] = height of dog sitting upright + 6 inches

B [ground clearance] =  $\frac{1}{2}$  x height of dog sitting upright

C [kennel width] = 4 feet

D [kennel depth - not shown] = 4 feet

Figure 9-4.--Construction Guide for Elevated Field Expedient Shelter

Section 9100 - Kennel Procedures

9101. Purpose. This section outlines procedures that apply to kennel operations both in garrison and deployment environments.

9102. Kennel Facilities. Kennels can range from temporary to permanent as previously discussed. All extended term MWD kennel facility sites will have, to some degree, accommodations for MWD support activities as described in Appendix K. In deployment, the kennel facilities will evolve as the base camp and AO supply channels mature, to include environmental controls, water and electrical service. Levels of construction for support activities may range from a small house trailer to an expansive permanent construction structure.

9103. Authorized Use. Only those dogs procured, trained, or accepted by DoD as an MWD, will be housed within the kennel facility or use any MWD equipment. MWD handlers in transit who wish to kennel an MWD overnight must make arrangements with the host KM before travel. Personal pets, unit mascots and stray animals **will not** be allowed in the kennel facility or be transported in MWD vehicles. Handlers and/or any personnel attached and working at the MWD Section will not be used to support the functions of a stray animal facility which must be located at least 100 yards from an MWD facility.

9104. MWD Emergency Evacuation Plan. Written procedures for evacuation of MWDs in case of fire or natural disaster will be included in an MWD section SOP. The MWD Emergency Evacuation Plan will be posted in an area that is readily available to all MWD personnel and a copy to the desk sergeant [see Appendix F].

9105. Summer/Winter Training Schedule. In geographical areas where the temperature may become very high, the KM should consider scheduling MWD training during the cooler part of the day when possible.

9106. Quarantine Area. Prevention of transmission of diseases, parasites, and worms to the main kennel facility and, consequently, to the other MWDs is best ensured by applying the following principals:

1. The VCO can provide specific quarantine guidance based on the disease and will be the ultimate authority on MWD quarantine special treatment/inspection requirements.

24 FEB 2020

2. Locate the quarantine site an adequate distance from the other MWD kennels within space limitations of the kennel compound [see paragraph 9004 for examples of temporary kennels for use when permanent facilities are not available]. A separate wash-down and sewage system is recommended, although this may not always be possible.

3. To prevent transmission of disease, personnel, who care for quarantine MWDs, should restrict their access to healthy MWDs. Prevention can be achieved by proper washing, disinfecting, or changing of clothes, gloves, and boots (dependent on potential threat). In some instances, proper washing may be sufficient, combined with using a foot basin with disinfectants [see figure 9-5].

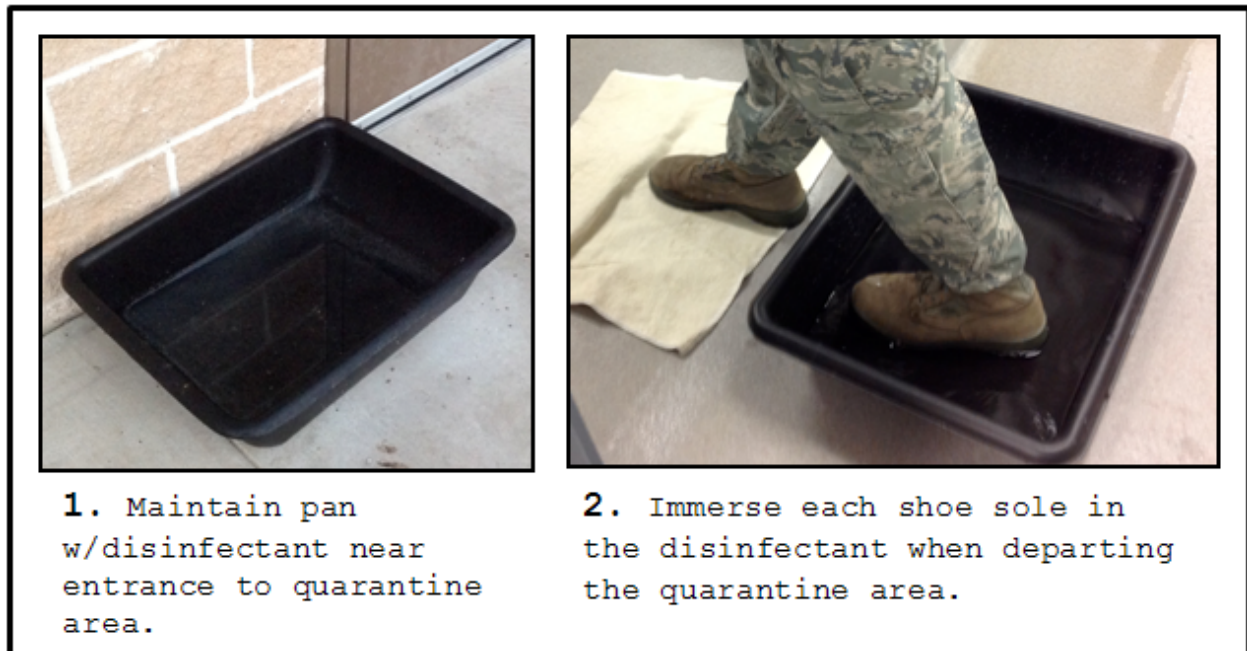

Figure 9-5.--Example Foot Basin for Quarantine Area

4. Clothing and other equipment that have been used in the quarantine kennel or by personnel assigned to the quarantine kennel should be stored separately from other clothing and equipment.

5. The mesh in fences should be small enough [1.5" max] to prevent birds and other animals from coming in and out of the quarantine kennel. These animals may transmit bacteria, viruses, parasites, or worms to other kennels.

6. Construct the quarantine kennel to prevent forced entry by other MWDs.



24 FEB 2020

7. Dispose of waste products from treatment or similar activity hygienically and carefully to prevent disease transmission. In cases of extreme danger of transmission, burn the waste products.

8. International and national quarantine requirements often exist. Investigate, respect, and adhere to these requirements and procedures. The ultimate responsibility for the health of MWDs rests with the MWD section.

9. If a suitable area has not been incorporated into the permanent kennel facility, consideration should be given to having a temporary kennel (see paragraph 9004) on hand for use as a quarantine area.

10. Local SOP shall provide procedures on meeting the requirement for a quarantine area.

9107. Security. The following minimum requirements must be met when the kennel facility is unattended:

1. An MWD handler must be on call at all times in case of emergencies.

2. The kennel facility must be secured at all times.

3. Keys must be readily available to the on-call handler.

4. Kennel Check. For safety reasons, a kennel check should be conducted every four hours outside of the normal duty day of kennel staff. The check should consist of visually verifying that each MWD is alive and well. Time, inspector name, number of MWDs checked and any corrective action will be recorded per local SOP which will also define responsibilities of security watch non-MWD personnel assigned to conduct checks during the non-duty hours.

9108. Facility Warning Signs

1. Language. All signs will be posted in English and the host nation language when MWD kenneling is conducted in operations where foreign forces or residents will be in close proximity to the MWDs.

2. Placement and Content. Per reference (x), warning signs shall be posted, if applicable, on kennel facility exterior fencing and exercise areas. These signs will be placed so that

personnel approaching the area from any direction will be able to read the signs at least 50 feet before reaching the runs. Signs will be clearly marked with sign text as shown in figure 9-6 [general guide is signs placed 100 feet apart on the perimeter].

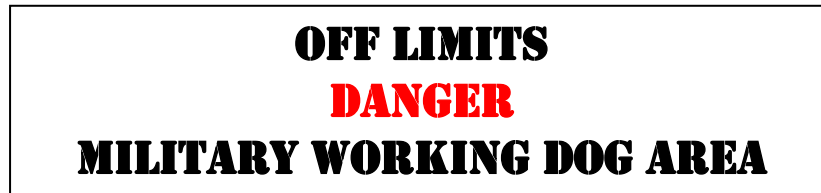

Figure 9-6.--Kennel Facility Sign

- a. Wording should be in 3-inch letters on white background.
- b. The word "DANGER" should be in RED lettering.
- c. Other text should be in BLACK lettering.

#### 9109. Sanitation

1. Introduction. Cleanliness is one of the most important factors for the good MWD health. The KM is responsible for facility cleanliness by enforcing the handler sanitation guidelines provided in this section. A good standard of sanitation is the result of the cooperation of the MWD handlers, KMs, supervisors, and the VCO.

2. Facilities. Kennel facilities must be sanitary, in a good state of repair, and thoroughly cleaned every day.

a. Disinfectant Use. Kennel Areas shall be disinfected on the following schedule using only those disinfecting products approved by the VCO:

(1) At least weekly.

(2) Prior to the reassignment of the kennel run to another MWD.

b. Pest Control. The entire kennel area must be free of refuse and garbage that could attract rats and insects. Mosquito control measures must be used in ditches and swampy areas in the vicinity of the kennels.

3. Stool Removal. Stool should be removed from the runs every four hours during duty hours. If the temperature is above freezing, the kennel floor should be washed after disposing of waste. The method of disposing of stool depends on local conditions and the type of sewage system present. If stool must be carried from the area in cans, the cans must be cleaned and disinfected after each use. The handler should clean up stool after each MWD use of the break and obstacle course areas.

4. Feed/Water Containers. The sanitation procedures below apply:

a. Feed Pans. Immediately after feeding, disinfect pans. The VCO provides guidelines and procedures for disinfection.

b. Water Bucket (Kennel). Wash daily and thoroughly cleanse with an approved disinfectant on a weekly basis.

c. Water Bowl (Plastic). Wash and disinfect as needed.

d. Plastic Food Storage Containers. Clean and disinfect as needed.

#### 9110. Food Storage

1. Location. Bulk storage of food must be in an area separate from the storage of other equipment, cleaning supplies, or materials that may contaminate the food. The VCO should be consulted on the selection of a suitable storage area.

2. Container. MWD food should be stored in a sealed container that will not allow contamination or rodents to enter the food (example: pail w/ lid, utility seven gallon, **NSN 7240-01-411-0581**). If food is stored in bags, the bags should be elevated four to six inches above the ground, preferably on wooden shipping pallets and neatly stacked with a four-inch space between the stacks and the walls.

#### 9111. Maintenance

1. Facility. The KM is responsible for ensuring that the facility and support equipment is maintained in good working order and that all areas are accessible, via operational gates, by maintenance vehicles. Work orders and necessary repairs must be initiated and tracked with the responsible command maintenance organization.

2. Training Area. Training areas must be kept clean and vegetation closely trimmed to prevent parasite, insect, and animal infestation. MWDs should not urinate/defecate in the training area. If fecal matter is present it must be removed immediately. Conduct a visual inspection of the training area prior to commencement of training to ensure no safety hazards are present [sharp objects, snakes, etc.] and that all obstacles are serviceable.

3. Break Area. An MWD break area should be located near the kennels. A break area allows the handler to release the MWD immediately after exiting the kennels or before entering the kennels. The area should be enclosed with a wire mesh fence. Personnel access gates should be self-closing/latching. Also, the maintenance gate should be a minimum of five feet wide to allow for lawn maintenance equipment. Unlike other grassed areas, a sandy area for cleaning ease is encouraged to be included.

4. Inspections. Refer to table 8-8 for information about the different facility related inspections that each MWD section should expect and prepare for. In addition, local SOP may dictate regular facility inspections by the base public works department for structure and utility issues.

5. Work Request. Each MWD section shall submit work requests for facility deficiencies per the base facility SOP. There is a management tool feature in WDMS [KM/Facilities] to record and monitor work requests.

6. Funding. If local funding is insufficient for facility repairs, the KM should notify the MWD PM [see Appendix C].

Section 9200 - Support Equipment

9201. Purpose. This section outlines requirements and policies associated with MWD support equipment.

9202. Definition. MWD equipment is defined as those items which are specifically required to support the welfare of the MWD and the mission of the MWD team (MWD/handler). The MWD PM is responsible to define requirements and plan for the acquisition, fielding, and life cycle management.

9203. Objectives

1. Selection. Equipment selection will be made to balance the primary objectives to:

- a. Minimize weight.
- b. Minimize overall logistics foot print.
- c. Maximize item utility.

2. Distribution. Equipment will be distributed with the objective of meeting the local KMs requirements for:

- a. Providing MWD care.
- b. Supporting daily MWD work assignments.
- c. Maintaining team readiness.
- d. Supporting team movements to other locations for training or deployment preparation.

3. Issue. Upon being teamed with an MWD, the handler will be issued equipment that is sized specifically for the MWD along with those items necessary for the basic care of the MWD while they are away from the kennel or in transit.

9204. Table of Equipment (T/E). The MWD section equipment authorization levels are those established in TFSMS which is the single, authoritative source for all force structure requirements and authorizations. Requests for revisions to the MWD section allowances are processed using the TOECR per reference (v). TOECRs impacting the MWD section will be routed, via the system, to the MWD PM for review and comment.

**NOTES**

1. The MWD is considered a critical asset and is tracked under an assigned TAMCN as identified in table 4-1.
2. As of the writing of this Manual, the support equipment authorizations [including training allowance] for the MWD sections, both installation and LE BN, are still a work-in-process and not recorded in TFSMS.

9205. Funding. At the time of writing this Order, the MWD section is responsible for funding the procurement and maintenance of all categories of MWD equipment identified in table 9-2; whether through the Marine Corps logistics system or by direct purchase from commercial vendors/distributors. As funding becomes available, the MWD PM will assist the MWD section in obtaining or maintaining selected equipment. Once distributed, program purchased equipment becomes the custody of the MWD section who is responsible for the security, maintenance and accountability of the resource. See Appendix C for information about requesting funding assistance from the MWD PM.

9206. Handler Weapon. MWD handlers have been and will continue to be deployed in support of the global war on terrorism (GWOT). As such, these Marines require a shorter rifle for maximum effectiveness while handling a dog during combat operations and training. Additionally, garrison law enforcement duties require shorter rifles. Due to their length, M16 rifles are awkward and constantly strike the MWD during operations. This awkwardness distracts both the handler and the MWD, detracting from the mission and posing a risk to the safety and security of the team. It is recommended that each handler is issued either a carbine or pistol for team employment and training. Consideration should be given to issue a flashlight with attachment for the handler's issued weapon.

9207. Equipment Categories

1. Definition. The categories of equipment identified in table 9-2 and described in this section are necessary for the sustainment of the MWD Program. Individual items of equipment are discussed by category in this section. Individual pieces of MWD equipment may fit into more than one category.

Table 9-2.--MWD Equipment Categories		
Category	Sub Category	Description
Deployment	General	Item planned to be required during one of the deployment phases.
Garrison	General	Item required for MWD specific care support while in the garrison kennel.
Issue	Handler	Common use item issued to each MWD handler.
	Handler - Specific	Item to be issued to each MWD CTD/SSD handler
	MWD - Size	Item is stocked in various sizes and issued to each MWD team according to the physical characteristics of the MWD or [in limited cases] the type task to be accomplished.
Training	General	Item required for maintaining the MWD qualification both in garrison and deployment environment.

2. Deployment. Equipment that is required to support specific MWD missions and extended separation from the permanent kennel facility for special domestic or international deployments. These items are intended to augment and integrate with the services provided by the supporting organization to meet the special requirements of MWD operations. This type of equipment is primarily located at the LE Bn MWD sections.

3. Garrison. Equipment that is required to support the daily operations of a permanent kennel facility. These items are not permanent fixtures, but generally mobile and transportable with available material handling assets. The equipment is intended to stay at the kennel facility and not be relocated for training or deployment purposes. Although standardization of the equipment is preferable, the unique requirement of a kennel facility may justify procurement of a selected item for that MWD section location. Key items in this category are discussed below.

a. Facility. Table 9-3 shows the unique support equipment that should be utilized in the designated facility areas [will vary with size of the MWD section].

<b>Table 9-3.--Garrison Facility Equipment</b>		
<b>Facility Area</b>	<b>Equipment Examples</b>	<b>Use</b>
<b>Vet Exam Room (2)</b>	Exam Table Exam Light Walk-on Platform Scale	Animal Care
<b>Food Storage</b>	Large Refrigerator	Animal Care
<b>Food Preparation Room</b>	Dishwasher Washing Machine Dryer Refrigerator Ice Making Machine Medicine Cabinet (Locking)	Animal Care
<b>Kennel</b>	Large Water Pans Food Pans Duct Boards Quarantine Kennel (3) Pressure Washer	Animal Care
<b>Training Area</b>	Permanent obstacles Shade Coverings	Basic Skills training
<b>Administration Area</b>	Computer System (1) Printer/Scanner/Copier (1) Video Player & Screen Video Camera Digital Camera	<ul style="list-style-type: none"> <li>• Record MWD team activities</li> <li>• Document team performance</li> <li>• Document MWD injuries</li> <li>• Production of bite videos</li> <li>• Handler training</li> </ul>
<p>NOTES:</p> <p>(1) The following IT equipment [connected to the internet] requirements apply for the MWD section:</p> <ul style="list-style-type: none"> <li>• One computer per KM, trainer and for each three handlers.</li> <li>• One Printer/Scanner/Copier per eight WDMS users <u>or</u> one heavy duty Printer/Scanner/Copier per 20.</li> </ul> <p>(2) VCO can provide guidance on equipment specifications.</p> <p>(3) See section 9106 for additional information about setting up a quarantine area.</p>		

b. MWD Trailers. Trailers that are towed by commercial vehicles [tactical vehicles are not authorized to tow commercial trailers] are provided in various configurations [commonly six or eight kennels per] to each MWD section with sufficient kennel spaces to move all MWDs at one time. In addition to transporting MWDs to base operations and training sites, the trailers have a vital role in the emergency evacuation plan to move all MWDs away from the kennel facility.



(1) All trailers are Government property and require a registered license plate.

(2) All trailers shall be regularly inspected for sharp ends, broken doors and properly operating environmental control. See Appendix P for the MWD trailer examples and maintenance guidance.

(3) Trailer repair and maintenance is a command responsibility; however, the KM should contact the MWD PM (see Appendix C) for assistance when local funding is insufficient to complete required repairs.

(4) Markings. Same as for vehicles defined in the next paragraph.

c. Vehicles. Commercial vehicles are the primary means for transporting MWDs in garrison. Government Services Administration (GSA) leased vehicles are preferred with MWD markings installed. The vehicles have a vital role in the execution of the emergency evacuation plan to transport all MWDs away from the kennel facility.

(1) Table 9-4 provides examples of garrison type vehicles along with the intended use and minimum planning allowance.

(2) Patrol vehicles with K9 insert are essential in effectively utilizing MWD teams in support of base law enforcement operations.

(3) MWD vehicles should only be used by MWD personnel.

(4) Kennel masters should annually review MWD vehicle authorizations with the local fleet management office to ensure MWD section mission requirements are being met.

(5) Markings. MWD vehicles and trailers (except for tactical vehicles or when the MWD is transported in an enclosed container) must have clear markings on all sides (see figure 9-7 for example vehicle markings) -

**CAUTION - MILITARY WORKING DOG**





Table 9-4.--Garrison Vehicles		
Type	Example Image	Use / Allowance
Truck 4x4		<ul style="list-style-type: none"> <li>• Primary use to tow MWD trailer</li> <li>• Installed police package</li> <li>• One truck per MWD trailer</li> <li>• Kennel truck is substitute</li> </ul>
Explosives Truck		<ul style="list-style-type: none"> <li>• Cannot tow MWD trailer</li> <li>• [LE Bn] Two trucks per</li> <li>• [SE] One truck per</li> <li>• [HMX-1] One truck (crew cab for multipurpose)</li> </ul>
SUV		<ul style="list-style-type: none"> <li>• [LE Bn] Two SUVs per for support</li> <li>• [SE] Two SUVs per for patrol</li> <li>• [HMX-1] One SUV (or equivalent transport) for support</li> <li>• Cannot tow MWD trailer</li> <li>• Installed police package</li> </ul>
K9 Kennel Truck		<ul style="list-style-type: none"> <li>• [LE Bn] Six to eight trucks per</li> <li>• [HMX-1] One truck</li> <li>• Six to eight kennels per vehicle</li> <li>• Allows access to remote training areas</li> <li>• Supports emergency evacuation plan</li> </ul>



Figure 9-7.--Example MWD Patrol Vehicle Markings

4. Issue

a. Definition. Issued equipment that is required for the daily MWD handling. The initial issue contains both items that are necessary for control, training, and care of the specific type of MWD capability plus specialized equipment to augment the handler's basic issue gear.

b. Issue Process. These items are stocked individually at the kennel and have generic application for all MWDs, as well as some being size specific [e.g., collars, muzzles]. All items are issued by the KM [or designated supply NCO] to the handler who is responsible to maintain the equipment during the teaming assignment.

c. Appendix I is a guide to MWD equipment which is commonly issued to handlers.

5. Training

a. Definition. Training equipment is an item used during a training event to enhance the effectiveness of the qualification process. A wide variety of training equipment is essential in the development and maintenance of the MWD capabilities. These items are generally mobile, but there can be some exceptions as the permanent structures used in the obstacle course. The equipment is intended to be maintained at the kennel facility and only transported out of the area for short duration training exercises. In some cases, the item used during training is the same equipment that will be used in the operating environment [e.g., SSD radio, E-collar, reward]. Examples of the types of training equipment are provided in table 9-5 along with references in this chapter or other parts of this Order where additional information is provided.

Table 9-5.--Training Equipment			
TYPE	MWD APPLICATION	USE	MCO Ref.
Aggression	Patrol (P)	To train MWD at different phases of development.	Appendix I
Basic Skills	All	To enhance the MWD skills of basic control and overcoming physical challenges encountered in operational situations - Control	Appendix I
		Obstacles	Appendix K
		Gunfire	9207.5.b
Communication	SSD	To communicate with the MWD through verbal or direct signal.	9207.5.c
Drug Aid	DDD PDDD	To train MWD to specific drug odors.	Chapter 11 Appendix L
Explosive Aid	EDD PEDD SSD	To train MWD to specific explosive odors.	Chapter 12 Appendix M Appendix O
Reward/Toy	All	To encourage/reinforce MWD when it completes a task successfully to include kongs, balls, and mechanical release device.	Appendix I

b. Gunfire. Reference (o) requires each MWD be accustomed to gunfire and Appendix D provides training and evaluation guidelines to establish the basic skills qualification in gunfire. Due to the cost and range availability of live ammunition, use of blank firing devices has proven to be the most practical gunfire training method in both the military and civilian LE. The following instructions apply to maintaining gunfire training aids:

(1) Noise Options. The gunfire qualification requirement can be fulfilled through the use of live fire or equivalent simulated sound to include the following:

- 5.56mm (M16 Rifle, M4 Carbine) [live or blank]
- 9mm (M9 pistol) [live or blank][see table 9-6]
- Any noise simulation [e.g., propane/oxygen activated device] to produce a simulation of gunfire should produce noise in the following ranges as measured three feet from the device:
  - o Single Impact: 130 to 140 dB peak
  - o Repeated: 110 to 130 dBA

(2) Blank Training Device. The blank training device must be marked so that it is easily recognizable as a blank training aid device. This will be accomplished by a change in color to the slide mechanism, hand grips or entire device being a traffic cone orange in color. Figure 9-8 provides an example of a gunfire training kit that can be maintained by the MWD section.

**Consists of:**

- **Firing Device, Blank, w**
- **Holster, w/Bandolier**
- **Cartridges, Blank**
- **Container, Ammo**
- **M9, 9mm Svc Pistol w/ Blank Conversion Kit**



Figure 9-8.--Example Gunfire Training Kit

<b>Table 9-6: 9mm Blank Accessories for USMC Weapons</b>	
<b>WEAPON</b>	<b>CONVERSION KIT [NSN](1)(2)(3)(4)</b>
<b>Pistol, M9</b>	<b>1005-01-457-4015</b>
<b>Pistol, Cal. 45</b>	<b>1005-01-457-4018</b>
<b>Rifle, M16</b>	<b>1005-01-457-4016</b>
<b>Carbine, M4</b>	<b>1005-01-454-9283</b>
<b>NOTES:</b>	
<p>(1) Cartridge, 9MM, Blank, DODIC AC07 [This cartridge is expected to be fielded during FY19 by PM AMMO.] Command allowances will be recorded in TAMIS based on the following <u>annual</u> requirement:</p> <ul style="list-style-type: none"> <li>• Base/Station PMO - 280 rounds (rds)/MWD [20 rds/Month-training, 20 rds/validation (2)]</li> <li>• LE Bn - 400 rounds/MWD [20 rds/Month-training, 20 rds/validation (2), 120 rds - combat scenario training]</li> </ul>	
<p>(2) Once blank allowances are in TAMIS, each MWD section will be able to draw the ammo from the local ASP per command procedures.</p>	
<p>(3) The above listed conversion kits are currently in inventory per command for use with the 9mm SIMS round.</p>	
<p>(4) The 9mm blank cartridge is expected to function in the pistols, but it is not known about the rifle and carbine. Testing and certification are still in process.</p>	

(3) Storage. The blank training kit will be stored per local SOP.

(4) Local SOP. Each MWD section shall prepare and utilize a local SOP that defines procedures to comply with blank training aid requirements stated in this chapter and topics to include, but not limited to:

(a) Notification of the desk sergeant when gunfire training commences and terminates.

(b) Area warning call before firing device.

(c) Checkout/in procedures.

(d) Ordering procedures for cartridges and replacement firing device.

(e) Use of the firing device as odor detection aid.

c. Communication

(1) For those MWDs that work off-leash at extended distances, use of direct communication means plays an important role in effectively maneuvering the MWD in search patterns. Communication devices range from the simple dog whistle to various types of electronic apparatus to transmit the handler's voice or a directional indicator. Figure 9-9 provides examples of the most common communication harnesses utilized primarily by the LE Bn MWD sections.

(2) When utilizing radio sets for MWD directional work, consideration must be given to the potential of interference with other radios in the area. Frequency selection and encryption issues must be coordinated with the command communications officer prior to any field training or actual operational activities.

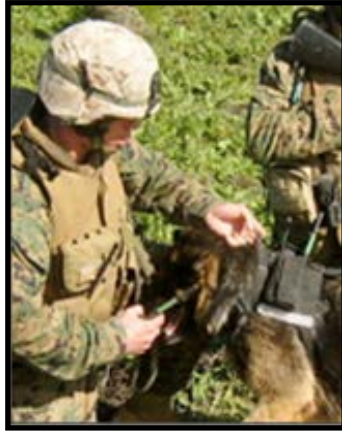

Figure 9-9.--  
Example MWD Radio Harness

## 9208. Maintenance

1. Introduction. Safety is the first consideration in the maintenance of MWD equipment, especially any surface or mechanism that will directly impact the MWD either through direct contact or in the case of an equipment malfunction. An inspection of all equipment should be conducted daily. Any equipment which is found to be unserviceable must be repaired/replaced immediately.

2. Leather. To prevent the leash, collar, muzzle and any other leather products from becoming dry/brittle, saddle soap/neat's-foot oil should be applied using a damp cloth. Rub neat's-foot oil, as well as saddle soap, into the leather with the fingers until the leather is soft and pliable. When not in use, all leather items should be kept in a dry location.

3. Metal. Metal equipment/parts of equipment should be inspected daily. Remove spots of rust by rubbing them with a fine grade of steel wool until all rust has been removed. Apply a coat of an edible oil to prevent rust from returning. Avoid leaving metal equipment in wet/damp areas. If an item of equipment becomes badly rusted, it should be replaced. Rusted water buckets should be replaced as soon as possible.

## 9209. Deployment Planning

### 1. Introduction

a. With the expanding role of MWDs in the War on Terrorism and military operations in general, Marine Corps MWD teams are being deployed to global locations, many of which are austere and pose extremely harsh environmental conditions. Sustaining

both MWD and team proficiency under such deployment conditions is a challenge since there are so many factors that influence the health and attention span of the MWD.

b. Pre-deployment exercises should include mission specific training and familiarization with the deployment equipment.

## 2. Selecting Deployment Equipment

a. Selection of equipment for an MWD deployment or special operations activity will depend on one or more of the following considerations:

(1) Number of MWD teams working out of the same base camp.

(2) Duration of the assignment.

(3) Future team rotation to the same area.

(4) Host command life support services.

(5) Type of MWD teams deployed.

(6) Special mission specific requirements.

(7) Projected frequency and expense of resupply/maintenance of MWD specific items.

(8) Requirement for KM support.

(9) Transport limitations.

b. Deployment kits should be considered as "Building Blocks" which, when the proper selection is provided, will support the MWD team with the minimum logistics footprint. Most Marine deployments are task organized and mobile in nature so MWD team(s) cannot be burdened with excess or redundant items.

## 3. Tactical Vehicles

a. Every command with assigned MWD teams should assign enough support vehicles so that all missions and kennel support activities can be properly conducted and maintained. Vehicle requirements should be determined by mission requirements and the overall number of MWD teams.



b. The general guide for vehicle planning is as follows:

(1) One support vehicle per two MWD teams (two dogs and two handlers) or;

(2) Solo team has two seats in the vehicle in which they will be transported [to minimize the risk of the MWD from biting passengers if the vehicle comes under enemy attack].

4. Deployment Site Layout. Each MWD deployment site will be established based on considerations for space, time, and security associated with the assigned mission. Figure 9-10 illustrates an example site configuration utilizing organic equipment for a mid-term situation.

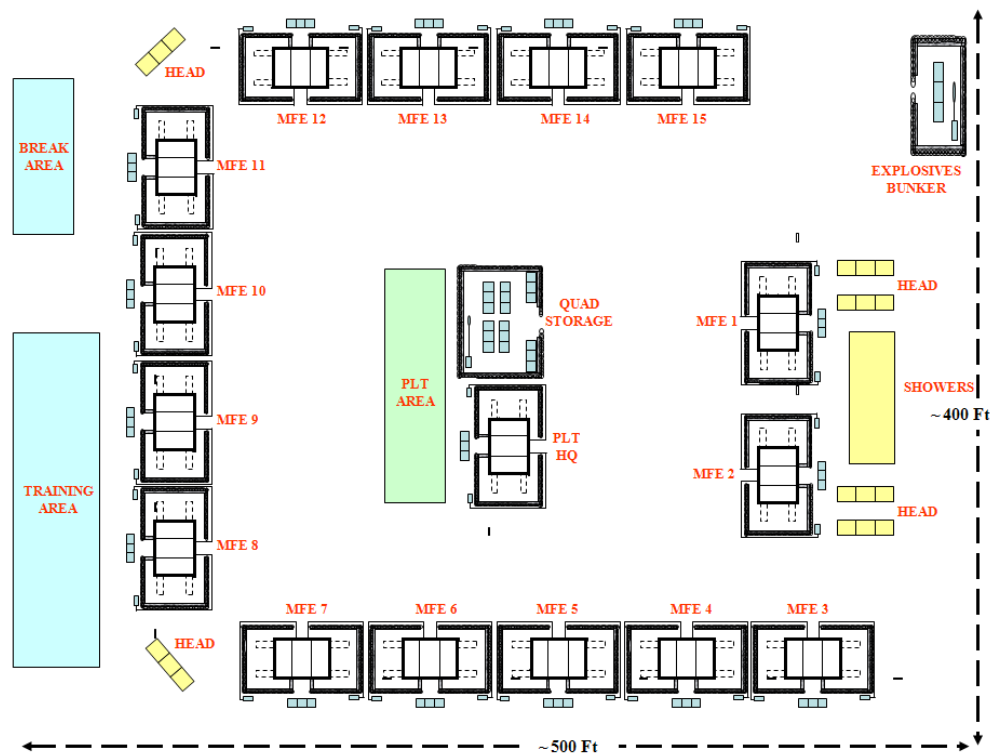

**MWD Field Element (MFE)** - Consists of four MWD teams and considered the most effective grouping size for planning combined handler and MWD housing.

Figure 9-10.--Example MWD Deployment Site Layout

24 FEB 2020

5. Logistics Support. While deployed, MWD teams will rely primarily on the host command for basic life support requirements [both MWD and handler] to include rations, munitions, living area, transportation, medical, batteries, security, and equipment maintenance up through organizational level. Any replacement of or extensive repair of any MWD unique deployment equipment will be coordinated through the designated area KM. Depending on the number of MWD teams operating in the area, the KM will maintain and distribute an in-country limited amount of replacement inventory. Deploying units are recommended to take a minimum of 30-60 days of MWD dog food depending on the availability of resupply and expected duration of the employment.

Chapter 10

Military Working Dog (MWD) Care

Section 10000 - Basic Care Activities

10001. Purpose. This section outlines procedures that apply to the activities involved in the basic care of the MWD.

10002. Responsibilities. The KM is responsible to ensure that the care and welfare of each MWD is conducted per the procedures in this chapter. The assigned handler will be directly involved with the MWD and bears the ultimate responsibility to perform these procedures in the proper manner to maintain the MWD health and readiness. It is imperative that the handler and MWD leadership continuously monitor the condition of each assigned MWD and promptly report any sign of illness or behavior change to the VCO.

10003. Daily Routine and Record Keeping. On a daily basis, the assigned handler or designated caretaker will follow the inspection and care guidelines as directed in this chapter. A record of performance will be recorded in the Food, Weight, and Stool Report (MC MWD-3). The chart will record key information concerning the scheduled MWD care and observations about the MWD eating and discharge. This record will be maintained on file for at least 60 calendar days, or longer as directed by the VCO.

10004. Feeding

1. Water. Ensure fresh water is available to each MWD in the kennels at all times, unless otherwise restricted by the VCO. Do not give MWDs more than three inches of water in their buckets immediately after exercise. When MWDs are sufficiently cooled down, fill their buckets from one-third to one-half of the bucket's capacity. Never fill buckets more than half full. The recommended water bucket is a nine quart stainless steel bucket with a flat back.

2. Food

a. An MWD requires a diet that is significantly different from that of pet dogs. Reference (x) requires that all MWDs be fed a standard diet unless a special diet is medically required and prescribed by the VCO.

b. Eating Frequency. The VCO prescribes the frequency of daily feeding for each MWD. This depends on the MWD duty schedule and the schedule of other kennel activities. An MWD should be allowed 15-30 minutes to eat after which leftover food is disposed of and feeding pans are cleaned and put away. Never leave uneaten food in the kennel past the authorized feeding period. If the MWD finishes its meal prior to the end of the feeding period the feed pan may be removed. The recommended feed pan is a stainless steel five quart bowl.

c. Standard Diet. Purchase of the standard diet dog food through GSA is a regulatory requirement. The MWD standard diet is a commercial product available through the Federal Supply System. The specific type and amount will be specified by the VCO. The standard GSA MWD diet is currently identified as:

**NSN 8710-01-415-6950**

d. Special Diet. Special diets may be procured and fed to an individual MWD when the VCO determines that other than the standard diet is required. These diets are available from the VCO for the first 30 days; after which the command must make funding arrangements to pay for the diet.

e. Stocking Level. The MWD section shall maintain a minimum one month supply of dog food. MWD teams in transit, with the exception of TAD less than 30 days CONUS will carry at a minimum, 30 days supply of dog food. For CONUS TAD less than 30 days, the handler will carry the minimum food ration to cover the period of employment.

f. Food as a Reward. Food is not the primary reward for any MWD. In special circumstances, food may be used as positive reinforcement in MWD training. The VCO approves the type of food used for training.

10005. Weight Control

1. Military Working Dog (MWD) Ideal Working Weight (IWW). Each MWD is assigned an IWW along with an associated daily ration amount, which the VCO determines based on the MWD size, age, reward, and most importantly, performance. If the MWD performance declines, notify the VCO for possible adjustment to the IWW or the daily rations which can only be adjusted by the VCO.

2. Weight Schedule. It is the handler's responsibility to monitor their MWD weight and notify the KM when the MWD varies out of the IWW. Handlers will conduct weekly weight checks on the date specified by the KM.

3. Reporting. Weights will be recorded on the Food, Weight and Stool Report (MC MWD-3) on the date conducted. The weight will be reported at least monthly to the VCO in a format requested by the VCO.

10006. Physical Conditioning. Physical conditioning training will be conducted with all MWDs in accordance with the basic skill sections of tables D-4. The VCO can provide guidance on a more rigorous conditioning routine or a waiver for MWDs with restrictive medical conditions or awaiting disposition. The KM is responsible to ensure handlers and caretakers are participating in a conditioning program and recording the activity in WDMS [Basic Skills/Conditioning].

10007. Grooming and Inspection

1. Grooming

a. While grooming an MWD with a double coat, using a brush and comb, the handler inspects the skin by lifting and moving the hair.

b. The following information discusses systematic methods for grooming an MWD:

(1) For multiple coated MWDs, the handler must first loosen dead hair by rubbing against the grain of the hair with the fingertips. At the same time, dead hair is loosened and skin is exposed for inspection. The undercoat should be soft and slightly oily, and the skin clear of infections, sores, and lacerations.

(2) The next step is to brush against the grain of the hair with a stiff bristle brush to get dead hair and dirt out. While performing this step, continue to watch for sores and lacerations.

(3) Next, brush with the grain of hair to complete removal of dead hair and dirt. This also returns the hair to its natural position.

24 FEB 2020

(4) Now stroke the MWD coat with the grain using the palms of the hands. Feel for bumps or cysts not noticed during visual inspection. Remove matted hair with a comb. This action will bring the MWD natural body oil to the surface which will coat the hair and act as a water repellent.

2. Inspection. After completing basic grooming steps and skin inspection, conduct the MWD health point check as defined in table 10-1.

<b>Table 10-1.--MWD Health Point Check</b>		
<b>MWD Part</b>	<b>Normal Condition</b>	<b>Abnormal Condition (1)</b>
<b>Nose</b>	Nose pad is normally shiny and moist.	<ul style="list-style-type: none"> <li>• Persistently dry and dull pad</li> <li>• Watery, yellowish, or red-tinged discharge.</li> </ul>
<b>Mouth</b>	<ul style="list-style-type: none"> <li>• Lips appear bright pink.</li> <li>• Teeth should be firm with white appearance.</li> </ul>	<ul style="list-style-type: none"> <li>• Lips appear pale.</li> <li>• Teeth have large deposits of tartar.</li> </ul>
<b>Eyes</b>	<ul style="list-style-type: none"> <li>• Appear bright and clear</li> <li>• Surrounding membranes pink in color.</li> </ul>	<ul style="list-style-type: none"> <li>• Cloudiness or discoloration of the cornea.</li> <li>• Puffiness of the lids.</li> <li>• Red or yellow discoloration of the membranes or whites.</li> <li>• Excess watery discharge.</li> <li>• Purulent (yellow or green pus) discharge.</li> </ul>
<b>Ears</b>	<ul style="list-style-type: none"> <li>• Small amount of brownish wax in the lower portion of the canal.</li> <li>• Pink flap w/o discoloration.</li> </ul>	<ul style="list-style-type: none"> <li>• Excess wax</li> <li>• Foul odor</li> </ul>
<b>Feet &amp; Leg</b>	<ul style="list-style-type: none"> <li>• Nails fairly short.</li> <li>• Feet clear of foreign objects and injuries.</li> </ul>	<ul style="list-style-type: none"> <li>• Lumps missed during grooming</li> <li>• Long or broken nails</li> <li>• Imbedded foreign objects in pad</li> <li>• Broken/lacerated pads</li> </ul>
<b>Genitals</b>		
<b>Penis</b>	[Located in a fold of skin known as the prepuce or sheath] - Small amount of greenish-yellowish discharge.	Excessive discharge and discoloration.
<b>Vulva</b>	Free of discharge and discoloration of any kind.	
<b>Anal Region</b>	Appears pink and free of foreign matter.	<ul style="list-style-type: none"> <li>• MWD drags its rear on the ground or bites at its anus [indication the anal sacks may need emptying, or worms].</li> <li>• Imbedded foreign objects</li> <li>• Broken/lacerated skin.</li> </ul>
<b>NOTES: (1) Immediately report abnormal conditions to the VCO.</b>		

10008. Military Working Dog (MWD) Fights and Bites

1. Introduction. Many MWDs have a natural desire to fight other dogs when they are brought together. Any MWD can become irritated or mistake a person's intent; thus, resulting in a non-directed bite of the handler or by-standers. It is important to use the following safe procedures when dealing with these situations.

2. Dog Fight

a. Breaking up a dogfight is a two-man project; no one should attempt to accomplish it alone. Fighting MWDs should never be pulled apart since the pulling may cause a ripping and tearing of the flesh and may disable the MWDs.

b. In breaking up a dogfight, handlers will:

(1) Keep their leashes taut and gradually work their hands toward the snap of the leash.

(2) Hold the snap end of the leash firmly with one hand and slip the other hand underneath the MWD collar.

(3) Grasp the collar tightly.

(4) Grab the throats of their MWD with their other hand at a point just below the MWD lower jaw.

(5) Choke their MWD until the air supply is cut off, thus forcing the MWD to release its hold.

c. Established procedures as outlined in the MWD section SOP must be followed when breaking up a dogfight. The handlers must be alert and prepared to control the MWD while the VCO provides examination/treatment. This is an abnormal situation for the MWD, and its behavior may not be as the handler expects.

3. Bite Incident

a. Bite Recovery. If a handler or other person is bitten by an MWD, use the same procedure to affect a release as used to separate two fighting dogs. Never attempt to jerk away from the MWD because this action may cause a serious wound.

b. After-Action. If a skin puncture occurs with an MWD bite, the person bitten should be referred to the local medical

facility for treatment. The VCO will be notified as soon as possible. It is expected that the MWD rabies vaccination will be current. The VCO will make a determination as to the course of action taken with the MWD. If the MWD is placed on a "working quarantine", it will not come in direct physical contact with other MWDs during the quarantine period. The handler will observe the MWD for any abnormal behavior or signs of illness and not utilize it for bite work until the end of the quarantine. The MWD is then reexamined at the end of the quarantine period and released if there are no further issues. Refer to Chapter 8 for guidance on recording MWD Status.

c. Preventative Measures. Handlers can avoid being bitten by their own MWDs. If the MWD attempts to bite, grab the leash close to the MWD neck, hold the MWDs front feet off the ground, extend arms to push the MWD away, and at the same time, slowly turn in a circle to keep the MWD off balance. These procedures will keep the MWD from seriously harming the handler.

10009. Military Working Dog (MWD) in Temporary Lodging. The following precautions apply when it is necessary that the MWD lives in the handler quarters during situations such as in hotels during off-base assignments or in temporary billeting during initial stages of deployment:

1. Control. MWD will be muzzled and on a leash at all times when moving through the lodging facility.
2. Kenneling. MWD will be secured in a transport kennel in the room when the handler is out of the room.
3. Entrance Marking

a. The hotel "Do Not Disturb" sign will be placed on the room entrance door when the MWD is in the room.

b. When operational conditions allow, the entrance to the expeditionary handler living area should display a sign "Caution - Military Working Dog".

4. Sanitation

a. It is important to minimize food exposure, waste and odor in the living area for health reasons, as well as consideration for other occupants of the facility.



24 FEB 2020

b. The handler shall remove all MWD waste and properly dispose of it.

c. MWD shall not be allowed to sleep in commercial lodging beds.

Section 10100 - Safety

10101. Purpose. This section outlines safety procedures that apply during the handling, employment and kenneling of the MWD.

10102. Introduction. Safety of the MWDs, handlers, and visitors to the kennel facility and in other work areas is paramount. Section personnel must be aware of their responsibility for the MWD actions and have a working knowledge of the following safety precautions as they apply at the kennel compound and in the operational environment.

10103. General. Following safety precautions always apply:

1. MWD Security/Supervision. The KM will ensure safety measures are complied with at the kennel facility and other MWD team working areas.

2. Only qualified (\*) MWD personnel will be allowed to handle, train or interact, to include the role of decoy, with the MWD except for an emergency (e.g., fire evacuation, natural disaster).

**(\*) "Qualified" meaning personnel holding the 5812 MOS or personnel who have completed on-the-job instruction to be a decoy.**

2. "Horseplay" with an MWD is strictly prohibited. Such actions could create harmful situations to the MWD and personnel in the area.

3. No one will touch or feed an MWD other than MWD personnel unless authorized by KM.

4. Handlers should maintain a safe distance between all personnel and MWDs.

5. MWDs will remain on-leash at all times when not in the kennel enclosed area or on an off-leash detection activity.

6. Staking Out MWDs. Handlers will utilize the following procedures for securing an MWD:

a. Use only the stake-out chain, a collar and a choke chain when an MWD must be staked out,

b. Never stake out an MWD to a vehicle.

- c. Never stake out an MWD where it could injure itself or others.
- d. Ensure the MWD has shade when staked outside.
- e. Check MWD regularly to ensure it has adequate water and not in distress.

10104. Muzzle Use. The muzzle is used when an MWD has been injured, being transported, or when visiting the veterinary clinic for an examination. MWDs shall be muzzled in crowded areas (hotel lobbies, airport terminals, etc.) when not conducting actual searches. Handlers must regularly check to make sure the MWD is breathing normally while muzzled. The following types of muzzles are used:

- 1. Standard. Appendix I illustrates several types of muzzles along with information about the purpose and recommended usage. Muzzle selection will be based on the situation, allowing for free breathing and causing the least alarm and apprehension. The handler must be aware that an MWD can still inflict a wound while wearing any type of muzzle, so caution is always required.

**CAUTION**

Monitor MWDs for overheating when using nylon occlusion muzzles in hot environments or with heavy activity. These muzzles prevent MWDs from panting, drinking, and breathing through the mouth.

- 2. Improvised. An improvised muzzle can be made using the MWD leash and is called a leash muzzle and is illustrated in figure 10-1. Follow the below steps to apply the leash muzzle:

**CAUTION**

The leash muzzle may be used when the leather muzzle is not available or when it would not provide adequate safety. Do not use the leash muzzle when the MWD is overheated, is having difficulty breathing, or is indicating that he may vomit. Do not leave it on for long periods in hot weather.



- a. Tighten the choke chain on the MWD neck by pulling the leash tightly with the right hand.
- b. Place the left hand, palm up, under the choke chain on the neck.
- c. Grasp the leash tightly as it passes through the palm of the left hand, wrap the leash once around the MWD neck, and bring it up and across the left side of the head.
- d. Wrap the leash twice around the muzzle and grab it tightly with the left hand.

Figure 10-1.--Example Leash Muzzle

10105. Kennel Compound. In addition to the general precautions above, the following safety precautions apply within the kennel compound:

1. Maintain positive control of the MWD while moving from one place to another within the kennel facility.
2. Ensure the kennel facility to include the kennel runs are secured at all times.
3. Caution should be used while feeding, watering and conducting daily kennel care operations.
4. In the event of a loose MWD, the alarm, "loose dog," will be "sounded" and all available kennel facility personnel will attempt to gain control of the MWD. If other MWDs are present, the handlers will maintain positive control while immediately removing this MWD from the area. These procedures must be clearly outlined in the MWD section SOP.
5. Maintain a safe distance between MWDs at all times.
6. Handlers will give a verbal warning, such as "MWD or dog coming through," "MWD or dog coming in," "MWD or dog coming around," or "MWD or dog coming by" or any other appropriate warning, when:

- a. Entering/leaving a room, area or building,
- b. Any time there is an obstructed view, i.e., going around corners or obstacles,
- c. When passing another MWD team.

10106. Military Working Dog (MWD) in a Vehicle. The following safety precautions apply when transporting an MWD in a vehicle:

1. MWDs will never be left unsupervised in a vehicle for an unsafe period of time. The MWD will remain in full view at all times. Another patrolman or handler can maintain watch of the MWD inside the vehicle if the handler has to be away for a short period of time.
2. See paragraph 9207.3.c for recommended types of K9 vehicles and proper markings. Vans and pick-ups should only be used in kennel support operations since these vehicles severely limit the handler's ability to access an MWD quickly and are not recommended for MWD patrol duties.
3. Transporting an MWD in a privately owned vehicle (POV) or in the front passenger seat of any vehicle is prohibited.

**Exception:** MWDs may be transported in the rear seat of a private vehicle (in transport kennel) if the Provost Marshal/Police Chief has approved in their emergency evacuation plan.

4. Rental vehicles procured for official use are considered government vehicles and as such all safety precautions stated in this section apply.
5. MWDs shall be secured in the vehicle to avoid injury from stops or turns. A passenger type vehicle with a K9 insert is the preferred method of transporting an MWD, but a secure transport kennel should be considered the minimum requirement except only in emergency situations.
6. If an MWD is in a stopped vehicle and not secured in a kennel, all vehicle windows must be rolled up far enough to prevent the MWD from escaping/injuring itself.
7. An MWD transporting vehicle shall have operating a/c and heating systems.

8. An MWD will not be transported in vehicles used to transport stray animals.

9. To prevent eye injury from insects or other foreign matter, the MWD must not be allowed to protrude out of the vehicle while the vehicle is in motion.

10. Since a vehicle interior can reach dangerously high/low temperatures during hot/cold weather, the handler must ensure the MWD has ample ventilation and suitable environment at all times while in the vehicle.

11. Installation of a remote temperature alarm system in MWD patrol vehicles is strongly recommended to avoid accidental MWD overheating injuries/death.

12. Installation of remote door opener is recommended for MWD patrol vehicles to allow quick MWD release to provide immediate backup support to the handler.

10107. Operational Safety. In addition to the applicable safety measures stated above, handlers shall comply with the following safety precautions during the process of employing an MWD in an operational environment:

1. Preparation. Some MWDs are excellent for school talks, etc.; however, they are not "pets"; exercise extreme caution at all times.

2. Handler Awareness

a. Constantly be aware of and alert to the things going on around them.

b. Recognize when the MWD is uneasy or becoming agitated and what events/conditions cause the MWD to react accordingly.

c. Never assume that a person knows the potential danger of the MWD.

3. Leash Use

a. Keep the MWD on a leash except when released to attack.

b. Keep the MWD on a short leash when working in or around large numbers of people.

4. Warnings

a. Give a warning to any unfamiliar individuals that MWDs will bite them if given the opportunity.

b. Before releasing an MWD to search a building, a handler must give a verbal warning to inform anyone that may be in the building that the MWD is about to be released.

c. Emphasize following to individuals working in immediate area:

(1) Do not pet an MWD without the handler's permission.

(2) Do not walk up on an MWD or handler from behind.

(3) Do not slap the MWD or handler on the back or give a slapping hand shake.

(4) Do not antagonize the MWD when staked out, in kennel or in vehicle.

(5) Once MWD is released, don't chase, distract or interfere with the MWD.

(6) Allow a safe working distance for the MWD.

10108. Emergency Handler Plan. Identify a fellow patrolman who, in an emergency, could take control of MWD if the handler is incapacitated. The selected individual should have a strong authoritative voice, know some basic commands, be familiar with the MWD and be willing to grab the leash to prevent the MWD from running off or interfering with medical care for the handler.

Section 10200 - Medical

10201. Purpose. This section outlines the support services and procedures associated with MWD medical care.

10202. US Army Veterinary Support

1. Introduction. The U.S. Army provides veterinary support for all MWDs as authorized by reference (ab). At most base/stations, veterinary support is provided by an assigned on-base VCO. When there is no on-base VCO, a VCO from a nearby military installation is assigned support responsibility.

2. Responsibilities. The U.S. Army provides professional veterinary support for the entire MWD Program through the Army Veterinary Corps with the following pertinent support:

a. Medical and surgical care at training facilities and bases/stations.

b. Inspections to ensure that the kennel facilities are sanitary [see table 8-8 for details).

c. A professional review of plans for new construction and modification of kennels, support buildings and sites.

d. Prescribing an adequate feeding program.

e. Instructing handlers and supervisors in all matters related to the health of an MWD; i.e., health, care, feeding, and first aid.

3. Military Working Dog (MWD) Health Record

a. Permanent File. Medical records, with original documents, may be kept at the office of the VCO, the local civilian veterinarian if not serviced by a VCO, or at the kennel facility with the administrative records, as specified by the VCO. Only veterinarian personnel are authorized to make or direct entries in the MWD medical record. Reference (x) includes instructions on the preparation and maintenance of the MWD medical record. Each handler is encouraged to review their MWD medical record and become familiar with the documents of table 10-2.



b. Travel Copy. Copies of necessary documents, as selected by the VCO, will be taken with the handler on deployments or extended special assignment.

<b>Table 10-2.--Key MWD Health Record Documents</b> <b>[Source: reference (x)]</b>	
<b>Ref.</b>	<b>Title</b>
DD 1626	Veterinary Necropsy Report
DD 1741	Military Dog Immunization Record
DD 1743	Death Certificate of MWD
DD 1829	Record of Military Dog Physical Examination
DD 2209	Veterinary Health Certificate
DD 2342	Animal Facility Checklist
SF 600	Health Record, Chronological Record of Medical Care

#### 4. Examinations and Documentation

a. Key MWD examinations are to be conducted within the following timeframes for the specified situation (other than for sick calls):

(1) Not more than 72 hours after the arrival at a new station (i.e., from 341 TRS, transfer from other kennel).

(2) Not more than 72 hours of the MWD return to a home station from an OCONUS assignment. It is important that the handler who deployed with the MWD be present for the examination so that the VCO can obtain a complete medical history from the time the MWD was gone.

(3) Additional examinations and documentation is required per reference (h) for MWDs prior to and after returning from assignment in regions where screwworm exists (specifically, Central and South America, Cuba, Southwest Asia). KM should consult with the VCO to ensure compliance with these requirements.

(4) At least every six months, a comprehensive examination [semi-annual physical examination (SAPE)] will be conducted per reference (x).

b. See paragraph 8203 for documentation requirements for shipping and transporting an MWD. The KM should coordinate with the VCO on OCONUS travel to determine the specific medical documentation requirements of the destination country.

24 FEB 2020

10203. Emergency MWD Care. The VCO is responsible for establishing emergency procedures for approval, provision, and payment for emergency, civilian veterinary support. Emergency, civilian veterinary support is authorized for the MWD when there is not a VCO available and/or care is beyond the capability of the veterinary treatment facility (VTF). The VCO will designate in writing a local civilian veterinarian for emergency use including name, address, telephone number, and detailed map on the VCO letterhead and signed by the VCO. A copy of the letter and maps will be posted in plain view in the facility and provided to the desk sergeant. In all instances of emergency care, immediately contact the VCO or designated representative for authorization prior to receiving local civilian veterinary support.

10204. Parasite Control

1. Introduction. An MWD is at risk of becoming infested with internal parasites (intestinal worms and heartworms), and external parasites (fleas, ticks, and mange). Some of these parasites may also transmit infectious diseases to the MWD.

2. Prevention. In order to prevent infestation and disease transmission, each MWD must be on a routine parasite prevention program supervised by the VCO. At a minimum, this must include the administration of a monthly oral (pill or chewable) heartworm preventative and internal parasite preventative and the administration of a topical, veterinary-prescribed external parasite preventative against fleas and ticks. Documentation of the MWD receiving this monthly oral pill will be recorded on the Food, Weight, and Stool Report (MC MWD-3) in the medication remarks section.

3. Deployment Areas. When deployed to areas with high parasite risk, any additional preventive measures will be prescribed by the VCO.

4. Flea/Tick Collar. Flea and tick collars will only be used when prescribed by the VCO.

10205. Medication. At times, the VCO prescribes special medication (to be given separately or mixed with food) for a sick or injured MWD. The handler must know how to administer these medications in both pill and liquid form.

10206. First Aid

1. Introduction. The handler's early recognition of symptoms of illness or injury normally allows sufficient time to get assistance from a VCO. Situations may arise when medical help is not immediately available. The seriousness of the incident may require the handler to take emergency actions to protect the life or health of the MWD.

2. Emergency Situations. In all emergency situations, notify the VCO as soon as possible so that the MWD can receive professional medical attention.

3. Military Working Dog (MWD) Control

a. When an MWD has been injured, the first consideration is to calm and immobilize the MWD. Pain and distress, however, may cause the MWD to respond to the handler in an unpredictable manner. The MWD may not respond to verbal commands and may attempt to bite the handler and anyone helping the handler. Whether to apply a muzzle or not depends on the nature of the emergency. General guidelines for muzzle use are:

(1) Do not use muzzle if the MWD is unconscious, shows any difficulty in breathing, or has suspected head injuries.

(2) Do not use nylon muzzle if MWD is in distress since it will restrict breathing and panting.

(3) Use a muzzle when the MWD is taken to a VTF for care or examination.

(4) Otherwise, a muzzle should be used for safety.

b. Refer to paragraph 10104 for the information about muzzle use and types available.

4. First Aid Kit

a. First aid kits should always be available in the kennel area, vehicles and at training sites. The handler should also carry a first aid kit as part of his or her equipment for the MWD on all operational missions. The VCO should determine the contents of the first aid kit for each MWD. When items are used from the first aid kit, they should be replaced with new items immediately. Ensure the expiration of medication is checked and disposed/replaced as needed through the VCO.

24 FEB 2020

b. The VCO should consider the skill of the handler, access to veterinary support, and emergency situations that may occur. The kit should contain supplies that will support the MWD First Aid tasks in reference (y). The first aid kit can vary depending on a TAD/deployment location and veterinarian services available at certain TAD/deployment locations.

c. Funding of Initial Issue and Replacement Items. The command is responsible for the procurement of the initial MWD first aid kit and the VCO shall provide replacement supplies as required. There is a current initiative to develop a DoD standard MWD first aid kit, but at the time of the writing this Manual, a fielding plan for the Marine Corps has not been developed.

## 5. Handler Training

a. Per reference (x), the VCO is required to provide training to the MWD handlers upon initial assignment and at least annually thereafter. This training is not meant to turn handlers into animal health technicians, but to give them the tools needed to provide emergency care until they can acquire veterinary support.

b. Handler training should be conducted per the standards defined in reference (o) and discussed in detail in reference (y).

10207. Acclimation. Acclimation after arrival to the AO is vital to the MWD health and performance. MWD section personnel should be aware of the following guidance when planning MWD activities:

### 1. On Arrival at New Location

a. The MWD should be exposed to outside environment for the same periods of adjustment as used by the handler.

b. When available and required, the MWD should be kept in an environmentally controlled kennel for adjustment to the new climate.

c. The controlled kennel temperature should be regulated to within 10°F to 15°F [hotter/cooler] of the area they departed.

24 FEB 2020

d. Since each MWD acclimation period is different, the handler should consult with the VCO on region specific acclimation procedures.

e. During this critical adjustment period, the handler must be vigilant in conducting MWD health point checks as specified in table 10-1.

## 2. Once Acclimated

a. An acclimated MWD does not require environmental control any more than a Marine.

b. The MWD takes longer to adjust body temperature during exercise because the MWD cooling comes from breathing or panting, vice the human response of sweating.

c. Generally, the MWD core temperature for work is between 101°F and 103°F.

d. Handlers should be aware of the MWD working temperature which should be checked regularly during training and operations. Generally at temperatures above 105°F, begin heat first aid per reference (y) and contact the VCO as soon as possible.

e. An area with environmental control for the MWD to recover quickly will aid in maintaining the MWDs drive to perform, but will reduce endurance the more times the MWD is taken in/out of the area.

## 10208. Military Working Dog (MWD) Medical Deployment Categories (Med Cat)

1. Definition. Reference (h) defines MWD Med Cat as a valuable management tool to establish the current medical readiness for each MWD based on medical condition and fitness for duty.

2. Age Consideration. Old age is not a disease and an MWD will not be downgraded due to age; however, with increased age comes increased incidence of illness or disability. These problems may warrant a change in the Med Cat.

3. Determination. The VCO and KM shall meet at least quarterly to discuss their findings and then categorize each MWD status to determine if Med Cat change is required. Also, the VCO should

recommend Med Cat status updates as needed after MWD examinations (e.g., sick call, routine).

4. Recording. Update the Med Cat status in WDMS per action shown in table 10-3. The Med Cat recorded by the KM in WDMS should match which is recorded by the VCO in the MWD health record and the Vet Corps data base. Since Med Cat is a key factor in determining MWD team readiness (see table 5-2), status must be updated no later than the established WDMS recording deadline [see paragraph 8104.2.a].

<b>Table 10-3.--WDMS Recording Guide for MWD Medical Deployment Categories (Med Cat)</b>			
<b>Med Cat</b>	<b>Deployment Status</b>	<b>Brief Condition Description [See Details in reference (h)]</b>	<b>Reporting Action Required in WDMS [KM/MWD Mgmt/Status]</b>
<b>1</b>	Unrestricted	Medically fit	Med Cat entry only
<b>2</b>	Restricted	Medical problems exist that slightly impacts performance.	Reason for restriction <u>must</u> be entered in the MWD "Med Cat Status Remarks" field.
<b>3</b>	Temporarily Non-Deployable	Medical condition exists that impedes performance and is under diagnosis, observation, or treatment.	<ul style="list-style-type: none"> <li>• The vet's Estimated Release Date (ERD) from Med Cat 3 <u>must</u> be entered in the MWD status comments.</li> <li>• Reason for restriction <u>must</u> be entered in MWD "Med Cat Status Remarks" field.</li> <li>• May require change of MWD status to: "Non-Operational Medical"</li> </ul>
<b>4</b>	Non-Deployable	Unresolved medical or physical problems exist	<ul style="list-style-type: none"> <li>• Reason for restriction <u>must</u> be entered in the MWD status comments.</li> <li>• May require change of MWD status to: "Non-Operational Medical" "@ Field - Pending Disposition" (once Dispo Package is submitted)</li> </ul>

Chapter 11

Drug Training Aids

Section 11000 - Policy

11001. Purpose. This section outlines and articulates the service specific policies and procedures that define the MWD drug scent training aid use in both garrison and deployment environments.

11002. Requirement. The current war on illegal drugs requires all installations and LE Bns to establish and maintain a DDD capability. To maintain an effective drug detection capability, each command authorized drug detection MWD asset [DDD, PDDD] must manage their drug training aids per the instructions provided in this Chapter.

11003. Involved Government Agencies. Like all other DoD agencies, the Marine Corps obtains drug training aids from the Armed Forces Medical Examiner System, Division of Forensic Toxicology, Military Working Dog Laboratory (AFMES/FORTOX/MWD).

**NOTE:**

The AFMES/FORTOX/MWD will be referred to in this chapter by the term "**AFMES**".

This organization packages and distributes kits that contain drugs that are obtained and controlled by the Drug Enforcement Agency (DEA).

11004. Operating Procedures. Reference (aa) is the drug training aid accountability guide published by AFMES. The current copy of this guide is maintained in the WDMS library and shall be used by user commands as their primary reference for general procedures for interacting with AFMES. As a supplement to the guide, this chapter provides Marine Corps specific and clarification instructions. The intent is to minimize the amount of instructional material and potential confusion associated with control of essential, but hazardous training substances. Contact the MWD PM [see Appendix C] for questions concerning potential conflicting procedural guidance.

24 FEB 2020

11005. Communications to the MWD Program Manager. Once the initial new MWD section account is completed [see section 11300], user commands are authorized to conduct procurement activities and updating documentation directly with the specified Government agencies without informing the MWD PM. AFMES may contact the MWD PM for assistance in situations when the commands are not responsive to inquiries.

**IMPORTANT**

Issues related to delays in obtaining drug training aids or training aid quality should be reported to the MWD PM [see Appendix C].

11006. Registration. Obtaining drug training aids requires registration and communication with multiple Government agencies. Procedural requirements will vary for CONUS and OCONUS commands as noted.

11007. Drug Training Aid Sourcing. Only drug training aids obtained from specified sources in this chapter are authorized for Marine Corps MWD drug training except when the training is authorized with another accredited Government Agency or civilian organization using like or equivalent drug odors.

11008. Substance Control. The control of drug training aids is a very serious matter since the drugs themselves are concentrated, high quality substances that pose a real threat to unit integrity and health if consumed for personal use. Constant attention and vigilance is necessary in the management of drug training aids.

11009. Military Working Dog (MWD) Team Drug Qualification. All Marine Corps MWD drug detection teams will be qualified in all the drug odors contained in the drug scent kit that is defined in this chapter as the standard for all commands.

11010. Military Working Dog (MWD) Imprinting on New Drug Odors. MWDs provided by the 341 TRS may not be initially certified on all the required drug odors in the drug scent kit which is confirmed by the drugs listed in the drug odor section or remarks section of the LAFB 375. The KM will ensure deficient MWDs are imprinted with the additional drug scents, for the first team detection validation, per the appropriate procedures in Appendix G. Successfully imprinted drug odors will be recorded in the remarks section of the LAFB 375.



24 FEB 2020

11011. Pseudo-Drug Training Aids. Training with pseudo-drug training aids is prohibited for Marine Corps MWDs unless approved in writing from the MWD PM. Advance approval from the MWD PM is required for use of DDDs for testing the effectiveness of Pseudo-Drug products provided by another Government agency or commercial vendor (see Appendix C).

11012. DEA Site Inspection. The DEA performs unannounced site inspections to check for drug aid accountability and security. KMs and handlers must ensure drug aid documentation and physical inventory logs are completed in accordance with current reference (aa) to pass these inspections.

Section 11100 - Canine Drug Scent Kit (CDSK)

11101. Purpose. This section provides description information about the drug scent kit utilized by MWD sections in both garrison and deployment environments.

11102. Configuration. MWD section drug scent kits will be standardized with the specified odor codes registered with the DEA and approved by the MWD PM. The standard Marine Corps drug training aid kit, used for MWD purposes, is termed the Canine Drug Scent Kit (CDSK). The CDSK components will be issued in the form of individual prepackaged, sealed and serialized drug training aids of various weights. No other DEA codes will be used unless approved in advance by the MWD PM [see Appendix C]. Appendix L provides the detailed data description of each kit component. The blank (empty) aid bags and tins are included in the kit to be used to extinct the MWD from the container image/odor.

11103. Allowance. The MWD PM establishes and updates the drug training aid allowance with AFMES as defined in Appendix L for each user command location. Procedures for establishing the allowance for a new MWD section are covered in section 11300. The Commands shall submit requests for additional drug scent kits via the chain-of-command to the MWD PM who in turn will provide an updated authorization document to AFMES (See Appendix C).

Section 11200 - Personnel

11201. Purpose. This section outlines and articulates the procedures and duties associated with the MWD section personnel involved in the control and use of the drug training aids in both garrison and deployment environments.

11202. Custodians

1. Assignment. A primary custodian and alternate are assigned in writing and play an important role in the management and control of drug training aids. Under normal circumstances, the KM is assigned as the primary custodian and the senior trainer as the alternate. Only one primary custodian will be assigned per location and only the minimum number of alternate custodians required to maintain training. The criteria for appointing an individual as primary or alternate custodian are:

a. Service. Appointee must be a member of the U.S. Government; civilian or military. A contractor shall not be assigned as a custodian.

b. Rank. Primary must be of the rank of corporal or higher (or civilian equivalent) and the alternate must be of the rank lance corporal or higher (or civilian equivalent). It is recommended that the primary custodian be of equal or higher rank than the senior authorized drug training aid user.

c. Availability. The command must ensure that the appointee has a working knowledge of controlled substance control and is readily available to perform the duties defined in this section.

2. Appointment Letter

a. In the interest of efficient administrative processing, user commands should use the consolidated drug training aid custodian/user appointment letter as shown in figure 11-1. Separate appointment letters are acceptable if required by local command procedures. This letter needs to be updated, signed and distributed when the following occurs:

- (1) Change in any of the custodians.
- (2) Change in command or custodian contact information.
- (3) Addition of an authorized training aid user.

**NOTE:**

Deletion of user does not require a new letter, but a pen change of lining out the person on the primary custodian copy is required.

b. The letter is signed by the PM/PC. See the distribution list at the bottom of figure 11-1.

3. Duties

**NOTE:**

Custodians are authorized to properly transport drug training aids, per paragraph 11407, for the purposes of issuing the aids at a training site or coordinating shipment to an approved receiving location.

a. Primary Custodian. Duties are as follows:

(1) Physically issue training aids to only personnel authorized per the current command appointment letter of figure 11-1.

(2) Maintain a training aid issue/return log to record daily transactions involving drug training aids [see paragraph 11410].

(3) Ensure all training aids are returned to secure storage at the end of training.

(4) Thoroughly inspect and weigh drug training aids before and after use to determine signs of damage, loss, leakage, or tampering.

(5) Visually inspect drug training aids at least bi-weekly (if not in regular use) to determine signs of leakage or tampering. Also, check the accuracy of the issue/return log entries at the same time as this periodic aid inspection.

(6) Report damage, loss, leakage, tampering, or theft [see paragraph 11408].

(7) Notify the command of any authorized user who potentially is not suitable for handling/using of drug training aids as demonstrated by lack of adequate control of issued aids or suspected misuse of controlled substances.

(8) Initiate action to obtain replacement/additional drug training aids to include signing DEA 222 forms (CONUS) or Replacement Requests (OCONUS).

(9) (CONUS) Ensure the DEA 222 form is completed and submitted within the 60 calendar day limit for document validity once completed.

(10) Coordinate the receipt and shipment of drug training aids to include action required to respond to a recall of drug training aids [see paragraph 11405].

(11) Maintain the Drug Training Aid Accountability folder (see paragraph 11410).

(12) Maintain the DEA 222 Form Log (CONUS) [see paragraph 11410].

(13) Ensure drug training aids are properly stored [see paragraph 11403].

(14) Ensure the required custodian and user authorization documentation is current and signed by the command [see paragraph 11202].

(15) Ensure required current documentation is provided to DEA and AFMES on a timely basis [see paragraph 11408 and reference (aa)].

(16) Coordinate with command to complete arrangements required to conduct a semi-annual physical inventory and upon change of the primary/alternate custodian, of the drug training aids and DEA 222 forms (when applicable) by a disinterested party [see paragraph 11410].

(17) Ensure the weight scale is calibrated per AFMES requirement [see reference (aa)].

(18) Be familiar with and maintain the required references [see paragraph 11410].

b. Alternate Custodian. The alternate can perform duties listed above in the absence of the primary custodian or as assigned by the primary except duties (8) and (9) where signing of AFMES procurement requests or DEA 222 forms is required. To conduct tasks (8) and/or (9), the command must obtain a power of attorney per figure 11-2 [distribution is noted at the bottom of the page]. The primary is still responsible to ensure these duties are conducted properly. At least one alternate should have a power of attorney to avoid transition issues in the event the primary custodian is suddenly unable to sign documents

**IMPORTANT**

Contact the AFMES Manager immediately in the event that the primary custodian is not available to sign the specified transfer documentation (e.g., death, serious injury, incapacitated) and the alternate does not have an existing Power of Attorney. Additional instructions will be provided.

4. Change of Primary. Changing the primary custodian requires expedient completion of the following transition procedures to avoid delays in drug detection training and effective management of controlled substances.

a. Power of Attorney (CONUS). Prior to the effective date of change, he/she shall have a legal officer prepare a Power of Attorney for DEA Order Forms (figure 11-2), authorizing the next appointed primary custodian to execute DEA 222 forms until such time as a new registration certificate is received. It is not necessary to apply for a new registration certificate for a change of the primary custodian. When a renewal application is received, the current appointed primary custodian shall sign it.

b. Physical Inventory. An inventory of all drug training aids and blank DEA 222 forms (CONUS only) will be conducted and reported before the primary custodian leaves the position or command [see paragraph 11410].

c. Change Documentation. Prepare and distribute the change of primary custodian letter with enclosure per figure 11-3.

5. Change of Alternate. All user commands shall transmit an updated command authorization letter of figure 11-1 to AFMES within 15 working days of the alternate custodian change. A physical inventory is not necessary, but the primary custodian should review requirements for a physical inventory in paragraph

24 FEB 2020

11410 especially if there are concerns related to why the individual is no longer a custodian.

11203. Authorized Training Aid Users

1. Requirements. Only authorized persons shall be allowed to sign out drug training aids from the custodian and use the aids for the purpose of training drug detection MWDs. Personnel must have completed the DoD MWD Basic Handler Course to be considered for authorization to use drug training aids. The command must identify qualified section personnel in the appointment letter of figure 11-1.

2. Controls. Drug training aids will be under positive control at all times. The aids must be transported per paragraph 11406. Sealed training aids are not to be intentionally opened or altered for any reason.

Section 11300 - New Military Working Dog (MWD) Section Account

11301. Purpose. This section outlines procedures for establishing a new MWD section account to maintain the CDSK.

11302. Startup Process. No less than 60 calendar days prior to the arrival of the first drug detection MWDs at a newly formed MWD section, the MWD PM will provide AFMES an updated CDSK allowance document. The MWD PM will also coordinate with the new user command to initiate the required actions for new accounts per reference (aa) as they apply to CONUS and OCONUS locations.

1. CONUS

a. DEA Registration. The requesting command will submit a registration letter of figure 11-4 which provides justification for maintaining drug training aids and signed by the commanding officer or delegate. This letter and application for registration form (DEA 225) will be sent to the DEA per on-line submission instructions (see reference (aa) for current DEA website). The DEA registrant name should be that of the USMC user command with the primary custodian as the authorized signee.

b. AFMES Registration. All MWD user commands must register with AFMES by submitting a copy of the DEA registration letter (figure 11-4), copy of the DEA 223 form, and a copy of the command appointment letter (figure 11-1). Reference (aa) provides the current AFMES mailing address.

**NOTE:**

The initial appointment letter may include only the primary custodian. An updated letter can be provided when the MWD section is fully staffed.

2. OCONUS. Commands will not register with the DEA, but will have to register with AFMES by the initial DEA request letter (figure 11-4) and a copy of the appointment letter (figure 11-1).

11303. Initial CDSK Issue. Once registered with the DEA and AFMES, AFMES will provide instructions and forms (CONUS Only) to the primary custodian for ordering the initial CDSK. OCONUS commands will submit the Request for Replacement Training Aids form (see reference (aa)) to AFMES for the initial CDSK.



Section 11400 - On-Going Activities

11401. Purpose. This section outlines the procedures that apply to on-going MWD section activities once the CDSK is received.

11402. Receiving

1. Process

a. AFMES will forward the authorized quantity of drug training aids to the designated primary custodian per the command request documents; form DEA 222 (CONUS) or the replacement form (OCONUS).

b. Current AFMES shipping service is defined in reference (aa).

c. An example of typical AFMES shipping package is shown in Appendix L.

d. The following are important receiving procedures:

(1) Receipt Security

(a) Ensure MWD section NCOs and duty watch personnel are familiar with established receiving procedures when one of the custodians is not available to sign for and secure a delivery of AFMES shipments.

(b) The senior Marine on board can sign for the receipt, but he/she must be aware what control measures must be taken until one of the custodians can take custody; i.e., lock in desk, cabinet, office or hand carry to custodian. One of the custodians shall be notified of a training aid delivery as soon as possible.

(c) Signs of a damaged outer wrapping or tampering must be noted on the carrier's receipt document and witnessed by the delivery person.

(2) Documentation. Receiving confirmation instructions will be included in the package and shall be acted upon within the required timeline.

(3) Processing. Only the primary/alternate custodians are authorized to open a drug training aid receipt package.

(4) Discrepancies. If the outer wrapping is intact, the package may be opened. If tampering is suspected, secure the area, report the situation to the local NCIS office and AFMES; do not proceed further until directed.

11403. Storage

1. Secure storage facilities, constructed per reference (ac) (Section 1301.72, Schedule 1 and 2), must be in place prior to the receipt of any drug training aid since security of the aids is of primary importance.

2. Proper security can be achieved by following procedures:

a. Security Container. Containers will comply with reference (aa). Do not store drug training aids within the kennel facility unless the above requirements are met and approved by the command [see Appendix K (para. 9) for kennel design considerations]. Typically, drug training aids are stored in the PMO/MCPD ready for issue (RFI) room.

b. Container Marking

(1) CONUS. A full size copy of the current form DEA 223 will be placed on the outside front of the top safe drawer.

(2) OCONUS. No marking on the safe.

3. Drug Safe Configuration. After security, the next objective in storing drug training aids is to minimize odor contamination. Table 11-1 provides the required training aid placement, depending on the number of safe drawers, necessary to minimize training aid cross-contamination.

<b>Table 11-1.--Drug Safe Configuration</b>			
<b>Safe Type</b>	<b>Two-Drawer</b>	<b>Four-Drawer</b>	<b>Five-Drawer*</b>
<b>NSN</b>	7110-00-920-9310	7110-00-920-9320	7110-00-919-9193
<b>Drawer [Top to Bottom]</b>			
<b>1</b>	Marijuana	Marijuana	Marijuana
<b>2</b>	Heroin Cocaine MDMA Methamphetamine	Cocaine	Cocaine
<b>3</b>		Heroin	Heroin
<b>4</b>		MDMA Methamphetamine	MDMA
<b>5</b>			Methamphetamine
<b>*Note:</b> For a 5-drawer safe, a common practice is to use the first drawer for admin tools (i.e., drug paperwork, cleaners, and scales) and then organize the drugs as in a 4-drawer safe.			

4. Training Aid Marking. See Appendix L for restrictions on adding identification to training aids. Loss of the original tag constitutes an unserviceable aid.

5. Unserviceable Aids. Damaged or leaking drug training aids are unserviceable aids which must be stored separately from intact drug training aids. This can be done by sealing the unserviceable aid in plastic and storing the drug training aid in a separate storage can in the safe.

6. Required Supplies. Each MWD section will maintain sufficient quantities of the following supplies as required to maintain drug aids per reference (aa):

- a. Alcohol (denatured).
- b. Cotton Balls.
- c. Gloves, latex.

11404. Weighing Aids

1. Procedure. Establishing the accurate weight of drug training aids is an essential step in the process of maintaining positive control. Weights are taken when an aid is checked out and returned from training use and during a physical inventory. The aid weight will be compared against the acceptable weight tolerances published in reference (aa) to determine if the aid has been subject to tampering.

2. Scale. The scale is to be compliant with reference (aa) and the following calibration requirements:

a. Calibrate new scale before first use.

b. Calibrate at least annually [dependent upon the technician's recommendation based on local conditions], using local command funding if required, by a certified technician [e.g., Precision Measurement Equipment Lab (PMEL), USMC MOS 6942 Calibration Technician, Navy Medical Calibration, local vendor].

c. A copy of the most recent calibration results is to be maintained in the accountability folder.

11405. Recall

1. Definition. Routine Revalidation of Training Aids [termed "Recall"] for the purpose to ensure accuracy and accountability of a selected number of drug training aids. The recall will be initiated in writing by AFMES in the form of a package that will consist of a recall letter, multiple forms, and instructions required for ordering replacement training aids.

2. Delay Notification. Contact AFMES immediately if a delay is expected. It is important that the processing of the recall be conducted within the required timeline.

3. Postponement. The command will notify AFMES in writing that the aids will be temporarily relocated for TAD or deployment (see section 11500) along with a request to postpone the bi-annual training aid recall until a specified date. AFMES will respond to each request on a case-by-case basis.

11406. Shipping

1. To AFMES. Do not send drug training aids to AFMES until permission has been obtained. The AFMES return approval document will provide the specific details for the mailing address, carrier, and package markings. Any change from the carrier method must be approved in advance by AFMES.

2. Other Locations. Operational requirements may dictate that the most effective means of transporting drug training aids is via mail or designated commercial carrier. In this situation, commands will follow the same packaging and marking guidelines

used for shipments to AFMES. Contact AFMES for questions concerning this type of shipment.

3. Custody Transfer. The commercial carrier representative picking up drug training aid packages does not need to sign the Daily Issue/Return Log or any other chain-of-custody document. The carrier tracking number is sufficient evidence of custody change and shall be recorded in the Daily Issue/Return Log as shown in the shipping examples of figure 11-8. Tracking documents will be maintained in the Accountability Folder with shipping documents (see paragraph 11410).

4. Transportation Requirements. Drug training aids will be transported on or off the military base in a Government vehicle. Any deviation will be authorized in writing, on command letterhead, by the PM/PC. If drug training aids are transported with the handler, the letter must state such (by aid name, weight, and serial number).

11407. Annual DEA Registration (CONUS ONLY)

1. Delays. Primary custodian should contact the DEA (per instructions in the DEA website) if documentation or guidance has not been received 21 days prior to certificate expiration.

2. Signing Authority. The signing primary custodian for the DEA 225A form must match the current appointment letter on file with AFMES in addition to the current Power of Attorney if there was a change in primary custodian since the last registration application (see paragraph 11202).

3. New DEA 223. Upon receipt of the new registration certificate form (DEA 223), a copy shall be sent to AFMES since a current DEA 223 form must be on file.

11408. Reporting

1. To AFMES. Commands delinquent in the timely reporting of the following key documentation are subject to restriction/delay of future drug training aid shipments or possible recall of all aids (applies to all commands unless otherwise noted)[See reference (aa) for details]:

a. [CONUS] Copy of the current DEA 223 form [or DEA 225A only if DEA 223 is expired]

- b. [CONUS] Power of Attorney for Primary Custodian (if custodian changed from the signature on current DEA 223 form)
- c. Current command Appointment Letter with current point of contact information
- d. Copy of the last semi-annual Inventory Report
- e. Power of Attorney for Alternate Custodian (if applicable)
- f. Copy of any law enforcement report associated with the loss or theft of a drug training aid
- g. Receipt acknowledgement documentation from the last AFMES shipment
- h. Change of primary custodian letter with physical inventory report enclosure

2. Unserviceable Training Aids. Unserviceable training aids are those that are damaged, leaking, outside weight tolerance, have a broken lead seal, the serial number is unreadable or have insect infestation. Such aids will be processed with the submission of figure 11-5 to AFMES per reference (aa). AFMES is accountable for all drug training aids and is solely responsible for the final disposition. Commands are not authorized to destroy any drug training aid.

3. Theft/Loss of Aid

a. The theft or loss of a drug training aid must be documented on form DEA 106 "Report of Theft or Loss of Controlled Substances" within 15 calendar days of the date of the discovery [see note below]. The local NCIS office, via the chain-of-command, must be notified immediately of any losses. Any command not in compliance with this directive and the AFMES reporting procedures in reference (aa) is subject to a recall of all drug training aids.

**NOTE:**

Completion of the DEA Form 106 does not apply to damaged aids in which the drugs remain contained in the tins/bags and are considered unserviceable.

24 FEB 2020

b. CONUS drug aids that are lost/stolen while issued for an overseas deployment must be reported per the CONUS procedures as expeditiously as possible. Justification for any delay must be documented and will be evaluated on a case-by-case basis for potential deficiencies in drug accountability.

c. If a blank aid container is missing or lost, a Memorandum for the Record shall be sent to the lab stating that the aid is missing, listing the identifier for the missing aid, and requesting replacement. A note should be made in the inventory log as illustrated in figure 11-8.

**Note:** Damaged blank aids should be retained and returned during lab recall.

#### 11409. Training/Drop Aid Use

1. Security. Authorized users listed in figure 11-1, will maintain positive security of training and drop aids while in their possession for the purpose of conducting MWD training.

2. Procedures. Compliance with the following procedures is necessary:

a. Prevent any cross substance or foreign matter contamination, i.e., plastic bags will not be used to transport drug training aids; glue, masking or scotch tape labels or any other foreign matter will not be placed on, in or near the drug training aids.

b. Wear disposable clear plastic food service handler's gloves when handling drug training aids to prevent human odor contamination and any absorption through the skin.

c. Visually check the drug training aids for physical signs of tampering or leakage each time they are checked out or in. Report any problems to the custodian and minimize further handling of the drug training aid.

d. The issued user shall return the drug training aid to the storage site by the end of the training day. Another authorized user can return the drug training aid in cases of emergency or an exception is documented by the command.

11410. Record Keeping

1. Standard Operating Procedures (SOP)

a. Each MWD section will have a drug training aid SOP that will include, but not limited to, the following local specific procedures:

- (1) Receiving/Shipping Drug Training Aids
- (2) Storage and Security
- (3) Issue and Turn-In
- (4) Use of Drop Aids
- (5) Custodian Schedule (daily/weekly/etc.)
- (6) Record Keeping (where maintained, etc.)
- (7) Reporting Discrepancies/Damage/Loss
- (8) Assignment of Disinterested Party
- (9) Conduct of Physical Inventory
- (10) Planning guide for drug detection events (training areas, suggested tasks, aid amounts, etc.)
- (11) Custodian Change
- (12) Points of Contact Information

b. This document is reviewed annually and updated when there are significant changes. The drug training aid SOP is an integral element in the section operations binder described in Appendix F.

2. DEA 222 (CONUS)

a. DEA 222 Form Log. The drug order form [DEA 222] is a serialized, controlled document (see Appendix E) which will be safeguarded and kept in a GSA-approved security container. An accountability log book will be used to record the status of all DEA 222 forms [blank, voided, completed]. The log book is maintained by the primary custodian and stored under lock and key with the unused DEA 222 forms [can be same safe as used for



storing drug training aids]. This log shall be kept in a bound log book, such as, NSN 7530-00-286-8363, or equivalent, per the example log of figure 11-6.

b. Disposal of DEA 222. Voided and completed order forms will be destroyed by shredding or burning after the document has been retained for two years after the aids they represent are no longer at the unit. See figure 11-6 for an example entry in the DEA 222 Form Log.

c. Lost/Stolen DEA 222. Reference (ac) (Section 1305.16) provides specific instructions relating to lost/stolen DEA 222 forms to include those lost in transmission. See figure 11-6 for an example entry in the DEA 222 Form Log.

3. Drug Training Aid Accountability Folder. The primary custodian is required to maintain a Drug Training Aid Accountability Folder to keep a record of all drug training aid transactions with AFMES. The folder will be safeguarded and kept under lock and key [may be same safe as used for storing drug training aids]. Figure 11-7 provides an overview of the configuration of the accountability folder. It is the primary custodian's preference as to the most effective type of folder to use; e.g., 3-ring binder, multi-pocket folder.

**NOTE:**

The Marine Corps options to maintain the physical inventory reports in the Drug Training Aid Accountability Folder versus having a separate Physical Inventory Binder as mentioned in reference (aa).

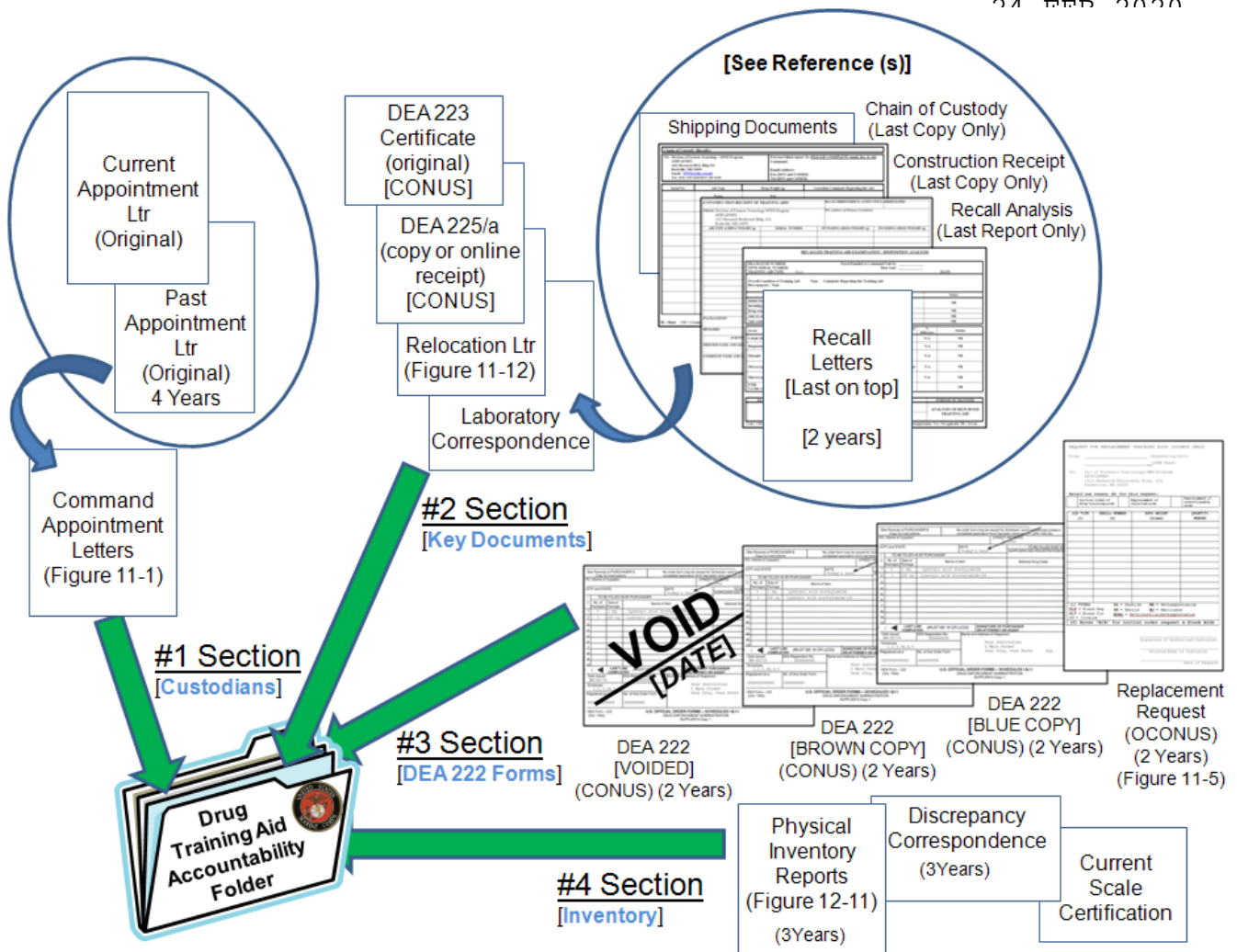

Figure 11-7.--Drug Training Aid Accountability Folder Configuration

4. Daily Issue/Return Log. The primary custodian will maintain a daily issue/return log to record daily transactions involving the drug training aids. The log shall be maintained in the same safe as used for storing the drug training aids. This log shall be kept in a bound log book, such as, NSN 7530-00-286-8363, or equivalent, and prepared per the format and example entries of figure 11-8.

5. Physical Inventory

a. To ensure accountability of drug training aids and the drug ordering DEA 222 forms (CONUS Only), physical inventories and reviews must be conducted per the following procedures:

(1) Frequency. Drug training aids/DEA 222 forms will be inventoried annually during the month of July and upon change of

the primary custodian. Another inventory is not required if there is a change of primary custodian inventory conducted during the same month. Also, the command can direct that a physical inventory be conducted at any time that misconduct associated with drug training aid handling is suspected.

(2) Conduct. The physical inventory will be performed by a disinterested party appointed by the PM/PC per the example of figure 11-9. The appointee must be an E-6/GS-8 or above who is not a subordinate of the primary custodian.

b. All drug training aids, to include separately stored unserviceable aids, will be inventoried and total weight verified by using the weighing procedures of paragraph 11404. Discrepancies will be reported immediately as a suspected Theft/Loss [see paragraph 11408].

c. A custodian (primary or alternate) will be present for the conduct of the physical inventory.

d. Drug Aid/DEA 222 Report. The disinterested party will prepare an inventory report per figure 11-10 and distribute per the note at the bottom of the figure. Also, he/she will make a signed entry in the Daily Issue/Return Log (see figure 11-8) and the DEA 222 Form Log [CONUS Only] (see figure 11-6).

e. Record Keeping. The primary custodian will maintain the physical inventory reports in chronological order [current in front] in the Drug Training Aid Accountability Folder [figure 11-7] covering the past three year period, even when this period overlaps a change in custodian. Correspondence and investigation reports relating to an inventory discrepancy shall be maintained behind the associated inventory report. Using divider tabs for each inventory report is recommended.

24 FEB 2020

Section 11500 - Relocation of Aids for Temporary Assigned Duty  
(TAD)/Deployment

11501. Purpose. This section outlines procedures that apply to relocating drug training aids to a remote site when the mission requires the maintaining of MWD qualification during periods of TAD or while on deployment.

11502. Assignment of Remote Site Custodian. If the entire drug training kit is required and the current primary custodian or alternate will accompany the kit for the period involved, no additional assignments are required. If only a portion of the kit is taken, one custodian must remain assigned at the home base. In large operational force commitments, it may be necessary for MWD drug detection teams to relocate out from the remote site in which case the custodian will issue the required aids to the forward teams. The remote site custodian(s) shall be included in the command authorization letter (figure 11-1).

11503. AFMES Notification. See figure 11-11 for a sample notification letter that provides key information about the drug training aids that will be relocated to a remote site. This notification will result in the suspension of the recall process for the relocated aids. CONUS users must be particularly attentive to renewing the DEA registration on a timely basis to avoid any complications if the relocation period extends past the current registration end date. AFMES shall be notified via email/fax on the return or possible delayed arrival of the relocated aids.

11504. Security. If travel to destination will be interrupted, this should be coordinated with the nearest military installation or civilian police agency to secure the drug training aids. While at the remote site, drug training aids will be stored in a manner consistent with garrison requirements and with consideration to the amount of drug training aids; i.e., five aids may be stored in separate containers in a one-drawer safe. The transporting of drug training aids via shipping methods of paragraph 11406 is recommended versus the handler hand carrying due to security issues. In the situation where hand carrying is the only practical solution, the aid type, amount, and serial number are to be added as an authorization line in the individual's movement orders.

24 FEB 2020

11505. Record Keeping. Drug training aids will be issued to the remote site custodian by the primary custodian with an entry in the Daily Issue/Return Log per the example in figure 11-8. The chain-of-custody documentation process is to be complied with at all times to ensure total accountability of the drug training aids. The remote site custodian will maintain a site Daily Issue/Return Log per paragraph 11410 (exception - a calibrated scale should be used at a remote site to record weight data, but may not be practical for a few aids). Semi-annual physical inventories will be conducted per paragraph 11410 with a copy going to the primary custodian. The remote site log will be returned to the home base and maintained by the primary custodian for a period of two years. The remote site Drug Training Aid Accountability Folder shall include copies of the notification temporary relocation letter (see figure 11-11) and DEA 223.



[COMMAND LETTER HEAD]

**EXAMPLE**

Date

MEMORANDUM FOR THE RECORD

From: PM/PC

Sub j: CONTROLLED SUBSTANCE ACCOUNT CUSTODIAN AND AUTHORIZED  
USER APPOINTMENT LETTER

Ref: (a) USMC MWD Manual, [MCO ID]

1. Per Reference (a), the personnel listed below from this command are designated custodians for the controlled substance storage container located in the Security Armory at Bldg. 0201.

NAME	DOD ID #	APPOINTMENT	EMAIL
2 <sup>nd</sup> Lt Person, Test Z.	1234567890	Primary	Test.Person@usmc.mil
SSgt Human, Fake A.	1234875403	Alternate	Fake.Human@usmc.mil
SSgt Fellow, Zero G.	1122335407	Alternate	Zero.Fellow@usmc.mil

//////////////////////////////////LAST ITEM//////////////////////////////////

2. The following contact information applies to both this command and the appointed custodians:

Telephone: (DSN) 345-1289, (COMM) 201-876-1289

Fax: (DSN) 345-6799, (COMM) 201-876-6799

Mailing Address for Controlled Substance:

PMO MWD Section  
Building 2170  
MCB Quantico, VA 22134

3. The following personnel are authorized access to all controlled substances in the storage container for the purpose of signing out and possessing for the sole purpose of qualification training of the drug detection Military Working Dogs assigned to this command.

NAME	DoD ID #	DUTY
SSgt Human, Fake A.	1234875403	Kennel Master
Sgt Being, Test	1122332185	Trainer
Cpl Blue, Sky	1578892047	PDDD Handler
Cpl Sea, Shining	2345672193	PDDD Handler
GS9 Mate, Paper Q.	1234568654	DDD Handler

//////////////////////////////////LAST ITEM//////////////////////////////////

Above authorized users have been formally trained and are fully qualified in the proper handling and use of drug training aids.

4. This letter supersedes all previous letters of the same subject.

\_\_\_\_\_  
(Signature, PM/PC)

Distribution:

Original - Command File

Copy - Appointees/ AFMES/ Custody Folder

Figure 11-1.--Example Custodian & User Appointment Letter

**[COMMAND LETTERHEAD]**

\_\_\_\_\_  
(Name of registrant)  
\_\_\_\_\_  
(Address of registrant)  
\_\_\_\_\_  
(DEA registration number) [CONUS only]

I, \_\_\_\_\_, the undersigned, who is authorized to sign the current application for registration of the above-named registrant under the Controlled Substances Act or Controlled Substances Import and Export Act, have made, constituted, and appointed, and by these presents, do make, constitute, and appoint \_\_\_\_\_, my true and lawful attorney for me in my name, place, and stead, to execute applications for books of official order forms and to sign such order forms in requisitions for Schedule I and II controlled substances, in accordance with Section 308 of the Controlled Substances Act (21 U.S.C. 828) and Part 305 of Title 21 of the Code of Federal Regulations.

I hereby ratify and confirm all that said attorney shall lawfully do or cause to be done by virtue hereof.

\_\_\_\_\_

I, \_\_\_\_\_, hereby affirm that I am the person named herein as attorney-in-fact and that the signature affixed hereto is my signature.

\_\_\_\_\_

Witnesses:  
1. \_\_\_\_\_  
2. \_\_\_\_\_

Signed and dated on the \_\_\_\_\_ day of \_\_\_\_\_, 20\_\_\_\_, at \_\_\_\_\_.

\_\_\_\_\_.

**THIS POWER OF ATTORNEY EXPIRES ON THE \_\_\_\_\_  
DATE THE PRESENT DEA  
REGISTRATION EXPIRES.**

**Power of Attorney must be approved by local JAG office.**

Distribution:  
Original - Custody Folder  
Copy - AFMES / Command File

Figure 11-2.--Example Power of Attorney for DEA Order Forms



[COMMAND LETTER HEAD]

**EXAMPLE**

Date

MEMORANDUM FOR THE RECORD

From: PM/PC

Subj: DRUG SCENT KIT PRIMARY CUSTODIAN RESPONSIBILITIES,  
TERMINATION OF, [Rank, FI, MI, LN, DoD ID # (EDIPI)]

Ref: (a) USMC MWD Manual, [MCO ID]

Encl: (1) Drug Scent Kit/Document Inventory Report [Date]

1. Per Reference (a), this document confirms the termination of responsibilities for the subject individual who was the appointed Primary Custodian for Military Working Dog (MWD) Drug Scent Kit(s) assets in this command.

2. Enclosure (1) is the inventory of the kit contents and applicable controlled documents completed in accordance with Reference (a).

3. There are no inventory discrepancies or disciplinary action associated with this termination of responsibilities.

4. An updated command appointment letter and Power of Attorney (if applicable) will be provided via separate correspondence.

\_\_\_\_\_  
Signature (PM/PC)

**Distribution:**

Original - Custody Folder

Copy - AFMES / Command File / Past Custodian if requested

Figure 11-3.--Example Change of Primary Custodian Letter





[COMMAND LETTER HEAD]

EXAMPLE

Date

From: PM/PC

To: (CONUS) Director, DEA  
OR (OCONUS) MWD Program Manager, Div of Forensic  
Toxicology, AFIP/AFMES/FORTOX/MWD Laboratory

Subj: INITIAL REGISTRATION FOR DEA DRUG SCENT KIT FOR MILITARY  
WORKING DOG TRAINING

Ref: (a) AFIP/AFMES MWD Drug Training Aid Accountability Guide,  
[Date]  
(b) USMC MWD Manual, [MCO ID]

Encl: (1) USMC Custodian & User Appointment Letter, [DATE]

1. Purpose. Per References (a) and (b), this document provides the required information for registration with the appropriate agencies to obtain and maintain controlled substances necessary to support this command's qualification process of Military Working Dog (MWD) drug detection.

2. Custodian/Users. Enclosure (1) is provided to contact information for the custodians (primary and alternate) who will manage the storage and use of drug training aids in accordance with the reference. Also, this enclosure identifies authorized users who have completed the DoD MWD Basic Handlers Course.

3. Controlled Substance Requirement. The Marine Corps allowance for this command is [Quantity] of the drug scent kit(s) containing each of the following drug controlled substance:

Schedule	Code	Controlled Substance
1	7360	Hashish
	7360	Marijuana
	7405	MDMA
	9200	Heroin
2	9041	Cocaine
2N	1105	Methamphetamine

4. All aids will be packaged, sealed and serialized by the AFIP/AFMES/FORTOX/MWD Laboratory.

Figure 11-4.--Example DEA / AFMES Initial Registration Letter  
(1 of 2)

5. MWD Drug Detection Authorization. The command is authorized to maintain [Quantity] Patrol Detection Dogs, NSN 882-00-024-7542.

6. Security Measures. In preparation of the receipt of drug training aids, this command has established the following security measures in accordance with the references:

a. Installed a GSA-approved security container [NSN ----], [number of drawers], weighing [Quantity] pounds. [if under 750 lbs, must include statement that the container is secured to floor]

b. The security container is located in building [number], in an area that is [manned on a 24-hour basis] or [protected by an intrusion detection system] [enter the appropriate system].

c. Drug training aids will be weighed with a calibrated scale [name, model] each time an aid is returned by an authorized user and during the conduct of a required physical inventory.

d. Records of all transactions of the drug training aids will be maintained in accordance with Reference (b) by appointed custodians of Enclosure (1)

7. Change from last distribution: N/A - First Distribution

8. Point of Contact: [command POC, contact information]

\_\_\_\_\_  
Signature (PM/PC)

**Enclosure:**

(2) - See Figure 11-1

Figure 11-4.--Example DEA / AFMES Initial Registration Letter  
(2 of 2)



[COMMAND LETTER HEAD]

EXAMPLE

Date

From: Authorized Custodian [Rank, FN, MI, Last Name]

To: Div of Forensic Toxicology/MWD Program, AFIP/AFMES  
1413 Research Boulevard, Bldg. 102, Rockville, MD 20850

Subj: RETURN OF UNSERVICEABLE DRUG TRAINING AID, REQUEST FOR

Ref: (a) USMC MWD Manual, [MCO ID]

1. Per Reference (a), this request is submitted for approval to return the following unserviceable drug training aid(s):

AID TYPE (1)	SERIAL NUMBER	DRUG WEIGHT (Grams)	ACTUAL WEIGHT (Grams)	CONDITION
(1) TYPES		CO = Cocaine	ME = Methamphetamine	
		HA = Hashish	MJ = Marijuana	
		HE = Heroin	MD = Methlenedioxymethamphetamine (MDMA)	

\_\_\_\_\_  
(Signature, Authorized Custodian)

**Distribution:**  
Original - AFMES  
Copy - Custody Folder

Figure 11-5.--Example Request for Return of Unserviceable Aid

DEA Form 222 Log  
[lined bound book]

RIGHT SIDE

RECEIVED				TRANSMITTED			
SERIAL #	CUSTODIAN	BRN	GRN	BLU	REC'D DATE	LOG DATE	
EXAMPLE ENTRIES							
S123456789	Anthony W. Smith				20090720	20090720	
S987654321	Anthony W. Smith				20090720	20090720	LAB 20090801 BLU Destroyed
S997664321	Anthony W. Smith				20100314	20100315	DEA 20100318 BRN Destroyed
S997664322	Anthony W. Smith				20100314	20100715	LAB 20090801
S999654321	Joe E. Marine				20100814	20100815	Joe E. Marine Destroyed
S899654375	Joe E. Marine				20100914	20100915	Joe E. Marine VOID- Reported Stolen to DEA
<b>INVENTORY CONDUCTED 20100916</b>							
GySgt Thomas E. Grunt, PMO Section Chief							

LEFT SIDE

RECEIVED				TRANSMITTED			
SERIAL #	CUSTODIAN	BRN	GRN	BLU	REC'D DATE	LOG DATE	
EXAMPLE ENTRIES							
S123456789	Anthony W. Smith				20090720	20090720	
S987654321	Anthony W. Smith				20090720	20090720	LAB 20090801 BLU Destroyed
S997664321	Anthony W. Smith				20100314	20100315	DEA 20100318 BRN Destroyed
S997664322	Anthony W. Smith				20100314	20100715	LAB 20090801
S999654321	Joe E. Marine				20100814	20100815	Joe E. Marine Destroyed
S899654375	Joe E. Marine				20100914	20100915	Joe E. Marine VOID- Reported Stolen to DEA
<b>INVENTORY CONDUCTED 20100916</b>							
GySgt Thomas E. Grunt, PMO Section Chief							

- 1
- 2
- 3
- 4
- 5
- 5
- 7

1. Custodian logs in blank form received with registration and still has valid form available for use.
2. Custodian logs in blank form received with registration and used form to order initial stock of aids. Brown and Green copies went to the Lab and blue copy was destroyed 2 years later.
3. Custodian logs in brown and green copies from Lab for recall. Green copy sent to DEA as confirmation of receipt. Brown destroyed 2 years later.
4. Custodian logs in prefilled form received with recall and used form to order replacement aids. Brown and Green copies went to the Lab and blue copy being held.
5. Custodian logs in ordered blank form and had to void the form due to error made during preparation. Form is destroyed after 2 years.
6. Custodian logs in that form was stolen and reported to DEA. Report is in the Accountability Folder.
7. Disinterested party makes entry in log specifying date of physical inventory of all DEA 222 Forms.

Figure 11-6.--DEA Form 222 Log w/Example Entries

Daily Issue/Return Log  
[lined bound book]

LEFT SIDE

RIGHT SIDE

ISSUE											RETURN							
DATE	TIME	AID TYPE	SER #	SIZE (g)	ACT WT (g)	CUST INIT	USER NAME	USER SIGN			DATE	TIME	ACT WT (g)	USER SIGN	CUST NAME	CUST SIGN	REMARKS	
EXAMPLE ENTRIES											EXAMPLE ENTRIES							
N/A	N/A	ME	098762	2	N/A	N/A	N/A	N/A			20090701	0900	2.0	N/A	A. W. Smith	Anthony W. Smith	NEW from Lab	
20090801	1400	ME	098762	2	1.99	AWS	A. J. Troy	Anthony J. Troy			20090801	1800	1.98	Anthony J. Troy	A. W. Smith	Anthony W. Smith	OK	
20101001	1100	ME	098762	2	1.98	AWS	T. A. Marine	Tom A. Marine			20101001	1800	1.75	Tom Marine	A. W. Smith	Anthony W. Smith	DAMAGED by MWD Aggress	
20101101	1200	ME	098762	2	1.75	AWS	N/A	N/A			N/A	N/A	N/A	N/A	N/A	N/A	DAMAGED - returned to Lab FedEx #1237890	
20101201	1200	HE	076523	5	4.99	AWS	N/A	N/A			N/A	N/A	N/A	N/A	N/A	N/A	RECALLED to Lab FedEx #1237890	
N/A	N/A	HE	085634	5	N/A	N/A	N/A	N/A			20101220	0900	5.0	N/A	A. W. Smith	Anthony W. Smith	REPLACEMENT from Lab	
20101225	0900	ME	060322	3	2.99	AWS	L. E. Watkins	L. E. Watkins									Mission Use - expect back 20110120	
20110115	1400	MD	082158	1	1.0	AWS	F. W. EDGE	Frank W. Edge									DEPLOYED - expect back 20110701	
20110405	1100	CO	082200	2	1.99	AWS	Witness E.F. Hut	E.F. Hut			20110405	1300	1.99	Witness E.F. Hut	AWS	Anthony W. Smith	OK	
INVENTORY CONDUCTED	20110716						Thomas E. Grunt	Thomas E. Grunt										
							Gysgt Thomas E. Grunt, PMO Section Chief											LOST/MISSING - MFR to Lab 20110717
20110717	1400	BLT	082160	N/A	N/A	N/A	N/A	N/A			N/A	N/A	N/A	N/A	N/A	N/A	N/A	

- 1
- 2
- 3
- 4
- 5
- 6
- 7
- 8
- 9
- 10
- 11

See next page for description of example log entries and aid type abbreviations.

Figure 11-8.--Daily Issue/Return Log w/Example Entries (1 of 2)

Description of Example Entries by Reference Line Number	
1.	Custodian checks in new aid from the Laboratory after initial registration.
2.	Custodian issues / returns aid to authorized user who returns aid same day with no discrepancies.
3.	Custodian issues / returns aid that was damaged during training by aggressive MWD action. NOTE: Command will need to investigate incident and report[see 11707] for unserviceable aid.
4.	Custodian checks out damaged training aid that is returned to the Laboratory <u>after receiving authorization</u> . Carrier tracking number recorded.
5.	Custodian checks out aid that was recalled and returned to the Laboratory. Carrier tracking number recorded.
6.	Custodian checks in replacement aid received from the Laboratory.
7.	Upon completion of the mission, record training aids on the return line directly across from the line where the aids were signed out.
8.	Upon completion of the deployment, record training aids on the return line directly across from the line where the aids were signed out.
9.	Custodian checks out training aid with witness signature for purposes of utilizing aid in training event.
10.	Disinterested party and Primary Custodian make entries in log specifying date of physical inventory of all DEA 222 Forms.
11.	Custodian records loss of blank tin training aid that was found missing during inventory.
<b>ABBREVIATIONS FOR DRUG AID TYPES</b>	
BLB = Blank Bag	MJ = Marijuana      ME = Methamphetamine
BLT = Blank Tin	HE = Heroin        MD = Methylenedioxymethamphetamine (MDMA)
CO = Cocaine	

Figure 11-8.--Daily Issue/Return Log w/Example Entries (2 of 2)



[COMMAND LETTER HEAD]

**EXAMPLE**

Date

From: PM/PC

To: GySgt Richards, Robert E.

Subj: DISINTERESTED PARTY TO CONDUCT DRUG SCENT KIT PHYSICAL  
INVENTORY, APPOINTMENT OF

Ref: (a) USMC MWD Manual, [MCO ID]

1. Per Reference (a), you are hereby appointed as a disinterested party to conduct the complete physical inventory of the Military Working Dog (MWD) drug scent kit(s) and controlled substance ordering forms, DEA Form 222 (CONUS), currently signed to the custody of this command.

2. The drug scent kit(s) and DEA 222 Forms are maintained in the safe located in building (number) at (address).

3. The physical inventory shall be conducted in the presence of the current primary custodian, SSgt Wall, Steven A., Kennel Master, [COMM/DSN] (301)798-0127 / 982-0127.

4. The results of the physical inventory are to be reported to the undersigned in accordance with the reference by COB [Date].

\_\_\_\_\_  
(Signature, PM/PC)

Distribution:

Original - Appointee

Copy - Command File, Primary Custodian for Custody File

Figure 11-9.--Example Disinterested Party Appointment Letter



[COMMAND LETTER HEAD]

**EXAMPLE**

Date

From: GySgt Richards, Robert E.

To: PM/PC

Subj: DRUG SCENT KIT AND DEA 222 PHYSICAL INVENTORY REPORT

Ref: (a) Disinterested Party Appointment Letter of [DATE]  
(b) USMC MWD Manual, [MCO ID]

1. Per Reference (a), this report is provided to summarize the results of the physical inventory conducted on [DATE] of the Military Working Dog (MWD) drug scent kit(s) and controlled substance ordering forms, DEA Form 222 (CONUS), currently signed to the custody of this command.

2. Drug Scent Kit Inventory. [List each kit separately]

[NOTE--Account for all kit components as it is supposed to be configured for each MWD section - several examples shown below.]

Aid Type (1)	Serial Number	Aid Weight (g)	Actual Weight (g)	Receipt Date (yyyymmdd)	Remarks
BLT	N/A	Qty 2	Qty 2	20090515	Blank Aid Tins - OK
CO	546585	1	.98	20090515	OK
CO	546586	1	.90	20090515	OK
CO	556585	2	1.90	20090515	OK
CO	556586	2	1.89	20090515	OK
CO	060322	3	N/A	20090701	Issued out for Mission
CO	060323	3	2.85	20090701	OK
CO	N/A	5	N/A	N/A	No aid
HA	060001	1	.89	20090518	OK
HA	060002	1	.90	20090518	OK
HA	689575	3	2.99	20090202	Loose seal
HA	060328	5	4.89	20090518	OK
HA	689580	10	N/A	20100318	Missing
HE	110007	1	.93	20090618	OK
HE	110008	1	.78	20090618	OK
HE	102587	2	1.95	20100518	Damaged
HE	102588	2	1.85	20090618	OK
HE	131113	3	2.73	20090618	OK
HE	151156	5	4.63	20090618	OK
MD	082158	1	N/A	20091106	Issued for deployment
MD	082004	2	1.84	20091006	OK
MD	786214	3	2.70	20091106	Out of tolerance
ME	226477	2	1.81	20091006	OK
ME	226478	2	1.91	20090328	Illegible Serial#

Figure 11-10.--Example Drug Training Aid / DEA 222 Inventory Report  
(1 of 2)



Aid Type (1)	Serial Number	Aid Weight (g)	Actual Weight (g)	Receipt Date (yyyymmdd)	Remarks
ME	230004	3	2.94	20091006	OK
ME	230005	3	2.98	20091006	OK
ME	N/A	5	N/A	N/A	No Aid - Recalled
ME	250004	5	4.91	20091006	OK
MJ	290023	3	2.85	20090601	OK
MJ	290024	3	2.96	20090601	OK
MJ	310012	5	4.82	20090601	OK
MJ	310013	5	4.92	20090601	OK
MJ	360112	10	9.4	20090601	OK
MJ	360113	10	8.95	20090601	OK
MJ	945632	20	18.10	20090601	Leaking
MJ	945633	20	18.75	20090601	OK
MJ	945634	20	19.54	20090601	OK
MJ	945635	20	18.95	20090601	OK
TOTAL AID WEIGHED = [Qty] [standard kit has 37 aids as listed above]					
(1) TYPES		HA = Hashish	ME = Methamphetamine		
		HE = Heroin	MJ = Marijuana		
CO = Cocaine		MD = Methlenedioxymethamphetamine (MDMA)			

Additional Comments: Listed by aid type/serial#/size:

Aid	Serial #	Weight	Comment
CO	N/A	5	Awaiting initial issue
HA	689575	3	Notification sent to AFIP 12FEB11
HA	689580	10	NCIS investigation in process
HE	102587	2	Notification sent to AFIP 12FEB11
MD	786214	3	Notification to be processed
ME	226478	2	Notification to be processed
ME	N/A	5	Returned to AFIP for recall 3MAR11 - replacement ordered 3MAR11
MJ	945632	20	Notification sent to AFIP 12JAN11

Custody Log signed [Date].

3. DEA 222 Forms Inventory (CONUS):

Serial #	Copy (X if Seen)			Status	Remarks
	BRN	GRN	BLU		
S123456789	X	X	X	Not Used	NONE
S987654321	----	----	X	Used	NONE
S997664321	X	----	----	Used	Torn in half
S997664322	----	----	X	Used	NONE
S999654321	X	X	X	VOID	NONE
S899654375	----	----	----	Lost/Stolen	Reported to DEA 20100917

Additional Comments: Log was not updated for S/N S997664321. No used carbon copies present in file. Investigation in progress for missing S/N S899654375. DEA 222 Log signed on [date].

4. Contact Information:

Rank / Name: GySgt Richards, Robert E.  
Phone: (COMM/DSN) (301)798-0127 / 982-0127  
Email: Richards.e@usmc.gov

(Signature, Disinterested Party)

**Distribution:**

Original - Commanding Officer  
Copy - AFMES, Primary Custodian for Custody File, Signee

Figure 11-10.--Example Drug Training Aid / DEA 222 Inventory Report  
(2 of 2)



[COMMAND LETTER HEAD]

EXAMPLE

Date

From: PM/PC

To: Military Working Dog Program Manager, Division of Forensic Toxicology, AFIP/AFMES/FORTOX/MWD Laboratory, 1413 Research Boulevard, Bldg. 102, Rockville, MD 20850

Subj: NOTIFICATION OF TEMPORARY RELOCATION OF MWD DRUG TRAINING AIDS

Ref: (a) USMC MWD Manual, [MCO ID]

1. Per Reference (a), this document provides the following required information relating to the temporary relocation of drug training aids to a remote site for the purpose of supporting proficiency training to Military Working Dog (MWD) teams who have been assigned to drug detection duties for specified period away from this home station:

Period of Temporary Relocation: (Date) to (Date)

Remote Site: [City, State, Country]

Remote Site Custodian: [Rank, FN, MI, Ln]

Training Aids:

Aid Type	Serial Number	Aid Weight (g)	Actual Weight (g)	Receipt Date

2. Arrangements have been made to ensure the above training aids will be covered by security measures consistent with those required for this home station.

3. (CONUS) The above specified period of relocation [does/does not] overlap the end of the current DEA registration.

4. Request that the recall process be suspended for these drug training aids during the specified period.

5. Point of Contact: [command POC, contact information]

\_\_\_\_\_  
Signature (PM/PC)

**Distribution:**

Original - AFMES

Copy - Command file, Primary Custodian for Custody File

Figure 11-11.--Example of Notification of Temporary Relocation of Drug Training Aids

Chapter 12

Explosive Training Aids

Section 12000 - Policy

12001. Purpose. This section outlines and articulates the policies that define the MWD explosive/non-explosive training aids use in both garrison and deployment environments.

**NOTE**

- **"Explosive Odor"** - refers to a characteristic odor for a material that is either an explosive or a component utilized in making an explosive device.
- **"Explosive Training Aid"** - refers to a training aid that is in the form of explosive substance manufactured for commercial or military purposes and requires special handling and security measures.
- **"Non-Explosive Training Aid"** - refers to a training aid that is in the form of a key component (i.e., oxidizer) used in the production of an explosive device but alone is a stable material.

12002. Requirement. The current global threat of terrorism requires all installations and LE Bns to establish an MWD explosive detection capability. Each command authorized MWD explosive detection assets [EDD, PEDD, SSD] must manage their explosive training aids per the instructions provided in this chapter.

12003. Determining Threat. The MWD PM works closely with other Government agencies to determine the nature of the explosive threat to Marine Corps installations and the operating forces. From this threat determination, the key odor types are selected for imprinting and training of MWDs to obtain the most effective detection capability for the majority of commercially produced explosives, as well as, components of improvised explosive devices (IEDs). Target odor training aids will change as the nature of the explosive threat evolves.

12004. Involved Government Agencies. The USMC obtains explosive components from the local Ammunition Supply Point (ASP) per a munitions authorization. The authorization is defined by the MWD PM and coordinated with the Marine Corps Systems Command (MCSC) and the Training and Education Command (TECOM). The Bureau of Alcohol, Tobacco, Firearms and Explosives (BATF&E) provides specialized explosives training on

request. Local EOD units have been utilized as a source of large volume training aids. Command logistics organizations are involved in procurement of commercially sourced non-explosive oxidizers.

12005. Operating Procedures. There are several referenced documents in this chapter that provide details concerning the specialized procedures associated with explosive compounds. This chapter will provide USMC specific clarification instructions with the intent to minimize the amount of instructional material and potential confusion associated with control of essential, but hazardous substances. Procedural requirements are the same for both CONUS and OCONUS commands unless noted otherwise. Contact the MWD PM [see Appendix C] for questions concerning potential conflicting procedural guidance.

12006. Communications to the MWD Program Manager. Once the MWD section explosive component allowance is in the Total Ammunition Management Information System \*(TAMIS), the command shall process requisition and ASP access documentation per reference (ad) without copying the MWD PM. Those Government agencies involved in providing explosive training aids may contact the MWD PM for assistance in clarifying MWD support requirements.

**\* NOTE**

TAMIS is a Department of the Army (DoA) system used by the Marine Corps for managing munitions. Kennel masters and trainers should register in TAMIS to complete tasks discussed in this chapter. Training briefs for MWD specific tasks in TAMIS are provided in the WDMS library.

**IMPORTANT**

Issues related to delays in obtaining explosive / non-explosive training aids or training aid quality should be reported to the MWD PM [see Appendix C].

12007. Explosive Odor Sourcing. Only explosive odors from sources specified in this chapter are authorized for USMC MWD explosive detection training. Training on specialized or blended explosive substances [see paragraph 12012], e.g., Homemade Explosives (HME), is only authorized with MWD PM approval [see Appendix C]. Requests for specialized substance training must include information about the chemical composition of the training aid, the source of the training aid, training location, and disposition arrangements of the substance (training aid).

**EXCEPTION**

The deployed KM is authorized to approve training and imprinting on AO unique explosive odors that shall be recorded in WDMS and on the DD 1834.

12008. Specialized Explosive Training. Any specialized explosive substances will require authorization for storage per reference (ae). The use of these explosives may require authorization from the base range safety authority. Specialized training involves imprinting with a HME that poses a new threat.

**Example:** Poor man's C4 (a composition of petroleum jelly, gasoline, or baby oil with potassium chlorate). Training an MWD to detect this substance requires a HME instead of standard potassium chlorate aid since poor man's C4 has a different odor.

12009. Substance Control. Explosive and non-explosive components pose a real threat to personal and public safety if improperly handled. Constant attention and vigilance is critical in the control and safety management of these training aids.

12010. MWD Team Explosive Detection Qualification. MWD explosive detection teams will be qualified on all the explosive odors identified in Appendix B (table B3-2, under "Production Objective"). The KM shall ensure that each MWD is qualified in all required odors for the first team detection validation.

12011. MWD Imprinting on Explosive Odors. MWDs provided by the 341 TRS may not be certified on all explosive odors required for USMC qualification. Appendix G provides guidance on odor imprinting techniques. All successfully imprinted odors will be recorded on the DD 1834.

12012. Mixing Versus Blending Explosive Training Aids. It is important that MWD section personnel understand the difference between MIXING and BLENDING components together and the authorization of using each.

1. Mixing. Placing different explosive training aids together for an event task in such a way that they can be separated after the training event. [MWD section personnel are authorized to mix components]. Essentially, the aids are collocated and not altered. However, collocating causes the aids to become contaminated or "dirty."

24 FEB 2020

2. Blending. Combining different explosive training aids together in such a way that they cannot be separated after the training event. [Only trained ordnance personnel are authorized to formulate and dispose of this type of training aid]. HME is the common term used for blending explosives.

12013. Pseudo-Explosive Training Aids. Advance MWD PM (see Appendix C) approval is required for any USMC MWD training with pseudo-explosive training aids; including effectiveness testing of such products provided by another Government agency or commercial vendor.

Section 12100 - Explosive Odor Training Aids

12101. Purpose. This section provides descriptive and procurement information for the chemical components that provide the explosive odors required for the training and qualifying of explosive detection MWD teams in both garrison and deployment environments.

12102. Explosive Training Aids

1. Source. The Canine Explosive Authorization Package (CEAP) is assembled by the ASP with Condition Code A explosives per applicable Ammunition Information Notice(s) (AIN) [see Appendix M]. Actual CEAP appearance and number of components may vary by command. Figure 12-1 provides an example of CEAP concept.

2. Allowance. Commands shall submit requests for CEAP adjustments to the MWD PM (See Appendix C) who in turn will coordinate a revision to the command explosive component authorization in TAMIS.

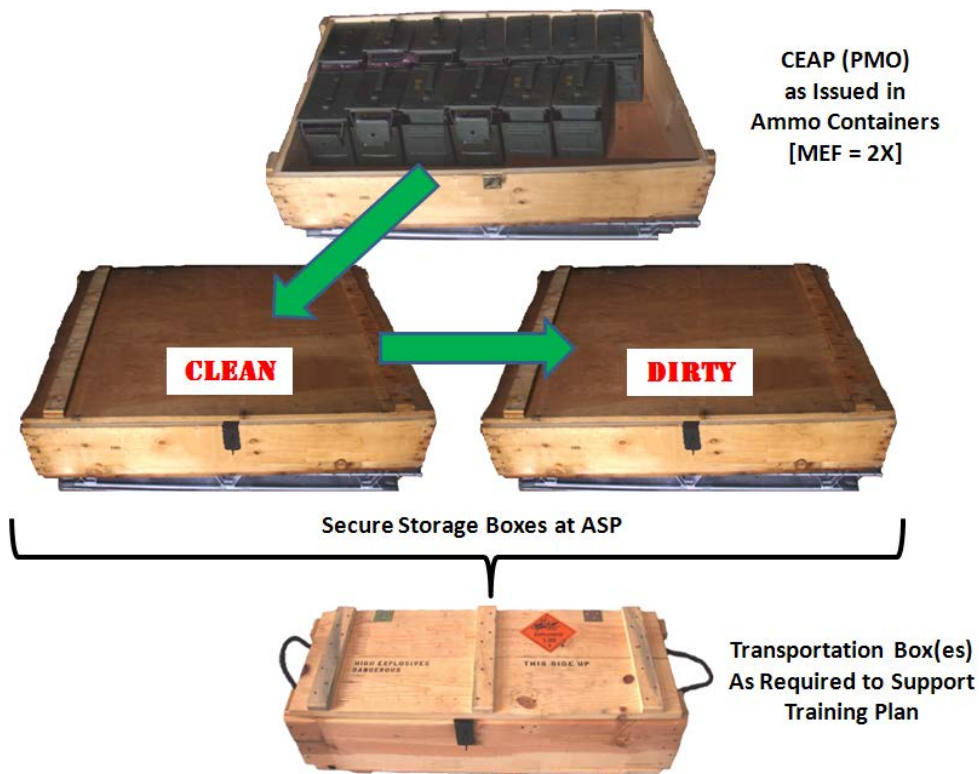

Figure 12-1.--Canine Explosive Authorization Package (CEAP) and Associated Containers - PMO Example

3. Configuration. Appendix M provides details of the CEAP identification and configuration that is standard for all Marine Corps applications. The appendix also includes safety precautions and inspection information.

4. Initial Receipt

a. Request. Once the command confirms the current CEAP component allowance in TAMIS, the TAMIS Unit Representative will submit an online TAMIS munitions request (E581) for the CEAP components identified in Appendix M.

b. Delivery. Once the ASP confirms the CEAP is assembled, the KM shall physically receive the CEAP and complete the transaction by signing the TAMIS-generated DD 1348, DoD Single Line Item Requisition System Document (Manual) form. Unless the command has a separate storage facility, the KM shall sign an ASP courtesy storage agreement and reissue the CEAP to the ASP via manually generated 1348 in owner code 3. This transaction is not a TAMIS-generated DD 1348 and is done to document "temp stow" and allow the ASP to track the presence of the CEAP in the magazine on the official record.

5. Pick-up Procedures. Personnel identified on the command Delegation of Authority form (NAVMC 11797) [see figure 12-2] can receive the CEAP at the storage facility [either ASP or command] for the purposes of issuing a selection of the kit components as required to support the training plan. The pick-up procedures will be one of the following depending on the storage arrangement:

a. ASP Stores CEAP. MWD section coordinates with the ASP to establish pickup notification procedures [standard is 24 hours in advance]. CEAP components will be returned to the ASP storage before the end of the training day unless other arrangements have been coordinated.

b. Command Stores CEAP. Commands will establish local SOP for access procedures to the storage facility.

6. Annual CEAP Replacement Cycle. The KM shall meet the following timeline to successfully complete the annual CEAP replacement cycle:

a. 31 August. Submit a TAMIS forecast that identifies the requirement for the CEAP components specified in Appendix M. This action will prompt the ASP to order the components. Also,



submit request (E581) for the CEAP components identified in the above forecast transaction for receipt after the start of the next FY and turn-in of the current CEAP.

b. 30 September

(1) All commands must complete an end-of-FY reconciliation of their explosive training aids utilizing the TAMIS system per reference (ad). The KM shall complete the Class V(W) Expenditure Report (NAVMC 11381) that is coordinated with the CEAP turn-in.

(2) Coordinate with the ASP for an effective turn-in/receipt schedule. Timing of CEAP turn-in shall not result in a training impact due to CEAP non-availability.

c. October [start of the new fiscal year (FY)]

(1) KM turns-in old CEAP at which time the ASP conducts a physical inventory and issues a form DD1348-1A for each CEAP component received.

**NOTE**

The total CLEAN and DIRTY quantities for each explosive component can be recorded on one form. Turned-in components will not be included in a future CEAP.

(2) After turn-in is completed, the KM can be issued the new CEAP as documented by the TAMIS generated DD 1348 form.

7. Unserviceable CEAP Components. When CEAP components are identified as unserviceable per Appendix M, the component will be turned-in to the ASP as recorded on a DD 1348-1A. The following procedures apply:

a. The MWD section shall maintain the original DD 1348-1A to show evidence that the CEAP quantity has been reduced. The ASP will record the return in TAMIS.

b. CEAP components will not be replaced out of cycle unless unusual circumstances apply when the majority of a component becomes unserviceable and the situation has an adverse impact on the MWD training. Contact the MWD PM (see Appendix C) to coordinate a component replacement.

c. Turn-in of CEAP components will be noted in the Daily

Issue/Return Log of figure 12-7 and the CEAP Data Card form (MC MWD-5)[see Appendix E for example].

d. There is no requirement to specially mark CEAP when a component is not replaced [e.g., LITE].

8. CEAP Component Condition. The condition of CEAP components will be identified as either "CLEAN" OR "DIRTY", as defined below. The CEAP will be issued in the CLEAN condition. Once components are utilized for training, the KM will incorporate procedures to separate and identify DIRTY condition components per Appendix M.

a. CLEAN. Components that are kept sterile with no cross contamination of odor. Used for MWD team validation and certification purposes.

b. DIRTY. Components that are cross contaminated with other components of the CEAP. Used for training purposes.

9. Integrity. Other than keeping the CLEAN and DIRTY training aids separated, there is no requirement on the MWD section to maintain lot number or expiration date integrity of the original CEAP issue.

**NOTE**

It is the intent that the CEAP lot numbers and expiration date will be the same for all aids within an explosive component. The ASP will track all pertinent data on components issued in the CEAP and notify the MWD section to unlock CEAP storage containers in order that ammo technicians can comply with AINs and Notice of Ammunition Reclassification (NAR) which provide restrictions, suspensions, and limitations on specified explosive lot numbers. AIN and NAR messages are compiled in reference (ai) and applicable AINs listed in Appendix M.

10. Maintenance. The CEAP components should remain as suitable training aids depending on the environmental conditions and wear due to MWD aggression. MWD section shall comply with the following CEAP maintenance procedures:

a. CEAP components will not be cut, separated or divided once they have been issued by the ASP. The on-going activity procedures of section 12300 apply.

24 FEB 2020

b. Initiate corrective action as required to support the ASP Data Base Administrator (DBA) initiatives to comply with applicable CEAP component NARS and AINs.

11. Net Explosive Weight (NEW). NEW is a computed measure of relative effectiveness of a given compound, and as such, is an important consideration when evaluating safe transportation loads, storage, and training aid planning [see paragraph 12303]. CEAP component NEW values are further explained in Appendix M.

12. Storage

a. Regardless of the storage arrangement, the CEAP will be stored per reference (af) [must meet requirements to store DoD hazard Class/Division (C/D) 1.1 and compatibility group D explosive materials].

b. Portable Magazine. When the situation justifies, the procurement, placement, and use of a portable explosive magazine may be authorized to store the CEAP.

(1) Procurement

(a) In cooperation with industry, the Marine Corps has developed the Canine Explosive Training Aid Storage Magazine (CETASM) which was designed and tested specifically for the type of explosive training aids currently required for MWD training and qualification.

(b) Commands are responsible for the planning and funding of portable magazine installation to include the high security lock and intrusion detection system (IDS).

(c) Interested commands should contact the MWD PM [see Appendix C] for the following information:

1. CETASM configuration compliance with current and/or in-process Marine Corps requirements.

2. Potential PM funding assistance and recommended instructions.

(d) Contact the following organizations for further information about the specified products:

CETASM:

ARMAG Corporation

[Toll Free Number] (502)-208-1553

[Email] info@ArmagCorp.com

[Website] <https://www.armagcorp.com/products/explosives-storage/k9-explosive-training-aid-magazine-cetasm/>

High Security Lock:

Crane Division

Naval Surface Warfare Center Code GXQS

Crane, Indiana 47522-5030

DSN 482-5860 or commercial (812)-854-5860

(2) Site Approval. Prior to procurement of a portable magazine, the unit must request a final explosives safety site approval through the Installation/Base ESO chain-of-command to the DoD Explosives Safety Board. Projected timeframe for approval is 120 days from time of submission.

(3) Physical Security Requirements. Reference (ag) applies to all physical security requirements applicable to the CEAP (consists of Category 2 items).

(4) Placement of Portable Magazine. The portable explosive magazine shall be placed or positioned at the location that was approved in the explosives safety site approval document. Although these portable magazines are physically capable of being moved, once site approval has been granted it cannot be moved or relocated without a new site approval.

12103. Non-Explosive Training Aids. The following are granular, non-explosive, oxidizing compounds commonly found in IEDs and as such are required USMC explosive detection odors:

- Ammonium Nitrate
- Potassium Chlorate
- Sodium Chlorate

1. Aid Assembly. Non-explosive training aids are to be procured, assembled and maintained as training aids per Appendix N.

2. Condition. Clean and dirty chlorate training aids will be maintained and used in the same manner as the CEAP [see paragraph 12102.8].

3. Accountability. Non-explosive training aids are not controlled substances, but since they are hazardous materials,

24 FEB 2020

the KM is responsible to establish procedures that enforce control measures identified in this Chapter.

4. Aid Variation. Trainers are encouraged to enhance detection training by varying the type of oxidizer containers used as the aid. Also, different manufacturing brands should be utilized.

Section 12200 - Personnel

12201. Purpose. This section outlines and articulates the requirements, duties and qualifications associated with the MWD section personnel involved in the control and use of the explosive/non-explosive training aids in both garrison and deployment environments.

12202. Roles and Responsibilities

1. Introduction. All MWD sections have a CEAP of which the majority are stored and maintained by the ASP. A few MWD sections will store and maintain the CEAP at a command facility. Regardless of the storage arrangement, the roles, responsibilities and procedures identified in this section remain the same.

2. Assignment

a. MWD Section Leaders. The KM and trainer play an important role in the management and control of explosive/non-explosive training aids. These two billets (as identified by BIC in the T/O) assume the duties list in paragraph 12203 by virtue of their assignment and being listed on the command Delegation of Authority as discussed later. The KM has the overall responsibility of training aids; with the trainer performing the role of an alternate in support of the KM's efforts. Depending on the size of the MWD section, additional number of trainers results in more alternates.

b. Users. Only authorized persons shall be allowed to receive and utilize explosive training aids, whether they are explosive or non-explosive, for the sole purpose of training explosive detection MWDs. Only personnel who have successfully completed a recognized DoD Basic Handlers Course (or equivalent) are authorized to set up explosive qualification events. Users will perform their duties described in paragraph 12203. Users may or may not be listed on NAVMC Form 11797 or on a separate access list per local ASP procedures.

3. Selection Criteria. The criteria for the KM, trainer, and handler billets are defined in section 3300, and all personnel must meet the qualifications per table 12-1.

24 FEB 2020

4. Delegation of Authority. Commands shall use the form NAVMC 11797 as shown in figure 12-2. This form shall be updated, signed and distributed when additions/deletions/rank changes apply.

5. Billet Holder Change

a. Kennel Master. Changing the KM requires completion of the following transition procedures to avoid delays in explosive detection training and effective management of hazardous materials:

(1) Physical Inventory. The incoming KM shall conduct an inventory of all explosive/non-explosive training aids before the outgoing KM leaves the command [see paragraph 12309].

(2) Change Documentation. Prepare and distribute the updated NAVMC 11797 (figure 12-2).

b. Trainer. A trainer change only requires preparation and distribution of the updated NAVMC 11797.

12203. Duties

1. Kennel Master. Duties shall include:

a. Sign for the annual CEAP receipt at the ASP and arrange storage (see paragraph 12102).

b. Coordinate the effective and timely CEAP turn-in to the ASP.

c. Coordinate with ASP to develop an effective CEAP pick-up notification procedure.

d. Manage the issue process of explosive training aids to only personnel authorized per the current NAVMC 11797.

e. Ensure all command personnel directly involved in the control and use of explosive training aids meet training and qualification requirements [see table 12-1].

f. Coordinate the construction and maintenance of containers required to effectively transport CEAP components to the training area.

g. Procure and maintain non-explosive oxidizers to support training requirements [see Appendix N].

h. Maintain current record keeping documentation that provides effective procedures and control for explosive/non-explosive training aids [see paragraph 12309].

i. Ensure all explosive training aids are returned to secure storage at the end of training.

j. Implement inspection procedures for explosive training aids before and after use to determine signs of damage, loss, leakage, or tampering [see Appendix M].

k. Report damage, loss, leakage, tampering, or theft [see paragraph 12307].

l. Ensure required current documentation is provided to the ASP.

m. Conduct physical inventories [see paragraph 12308].

n. Manage an effective explosive detection training program that utilizes the full range of authorized explosive/ non-explosive training amounts.

o. Be familiar with and maintain the external documents referenced in this chapter.

2. Trainer. The trainer can perform duties listed above in the absence of the KM except the duty of inspecting and accepting the CEAP unless unusual circumstances apply and with advance approval of the command.

3. User. Authorized users shall comply with the user precautions and safety measures identified in section 12300.

12204. Qualification and Certification. Commands storing the CEAP [either in portable magazine or other non-ASP facility] will establish an explosive handling qualification and certification program per reference (ah). Commands that store their CEAP in an ASP are exempt from these requirements.

12205. Training and Qualification. Those personnel associated with the control, transporting and use of explosive training aids will participate in training and be certified per table 12-1.



24 FEB 2020

Table 12-1.--Personnel Duties and Qualification		
Role	Duties	Qualification
<b>Kennel Master</b>	<ul style="list-style-type: none"> <li>• Requests, receives, and signs for CEAP from ASP and oversees issue and use.</li> <li>• Establishes, procures, and oversees storage and use of oxidizing aids.</li> </ul>	<ol style="list-style-type: none"> <li>1. <b><u>ASP Stores CEAP</u></b> <ul style="list-style-type: none"> <li>- Listed on NAVMC Form 11797.</li> <li>- Completed Arms, Ammunition and Explosive (AA&amp;E) screening per reference (ag).</li> </ul> </li> <li>2. <b><u>Command Stores CEAP</u></b> <ul style="list-style-type: none"> <li>- AA&amp;E screening per reference (ag).</li> <li>- Qual/Cert per reference (ah).</li> </ul> </li> </ol>
<b>Trainer</b>	Performs all KM duties in KM's absence except inspecting and accepting for CEAP unless approved by Command.	Same as KM.
<b>User</b>	<p><b>[Trainers/Handlers] -</b></p> <ul style="list-style-type: none"> <li>• Transports CEAP components to/from the storage facility.</li> <li>• <u>Directly</u> handles all aids in MWD team training and qualification process.</li> <li>• Also, possibly uses drop aids during utilization.</li> </ul>	<ol style="list-style-type: none"> <li>1. <b><u>All</u></b> - <ol style="list-style-type: none"> <li>a. Completed DoD Basic Handlers Course.</li> <li>b. Completed the approved <u>MWD Personnel Explosive Detection Safety Training</u>, conducted by senior MWD personnel, during the current calendar year. Record the annual MWD safety training in the Explosive Binder for inspection purposes.</li> </ol> <p><b>NOTE:</b> New handlers reporting after the Basic Handler's Course must complete the <u>MWD Personnel Explosive Detection Safety Training</u> while on assignment to the MWD section.</p> </li> <li>2. <b><u>ASP Stores CEAP</u></b> <p>Only personnel listed on NAVMC Form 11797 are required to complete AA&amp;E screening per reference (ag).</p> </li> <li>3. <b><u>Command Stores CEAP</u></b> <ul style="list-style-type: none"> <li>- AA&amp;E screening per reference (ag).</li> <li>- Qual/Cert per reference (ah).</li> </ul> </li> </ol>
<b>Explosive Driver</b>	<ul style="list-style-type: none"> <li>• Driving vehicle to transport explosive training aids to training locations on and off the base.</li> <li>• May involve checking out CEAP components, carrying to/from vehicle.</li> </ul>	<ul style="list-style-type: none"> <li>• <b>Military &amp; Civilian:</b> Must hold government explosive driver's license per reference (ak).</li> <li>• <b>Civilian handlers transporting 1.1 MWD explosive training aids off-base</b> on public roads or when crossing public roads must hold a commercial driver's license with additional hazmat endorsement per reference (ak).</li> </ul>
<b>Guard</b>	<ul style="list-style-type: none"> <li>• <b>Security duties.</b> May only be involved in carrying ammo cans, but not in issue/training process.</li> <li>• Not required to have explosive driver's license.</li> <li>• Requirement may vary by base/installation SOP.</li> </ul>	<ul style="list-style-type: none"> <li>• Qualified w/assigned weapon.</li> <li>• Instructed on base use-of-force measures.</li> </ul>

Section 12300 - On-Going Activities

12301. Purpose. This section outlines the procedures that apply to on-going MWD section activities once explosive/non-explosive training aids are received from the storage facility.

12302. Cross Contamination. Prevent any cross contamination of the odor, i.e., only anti-static bags will be used to transport explosive training aids; glue, masking or scotch tape labels, plastic bags or any other foreign matter will not be placed on, in or near the explosive training aids. See table 12-2 for CLEAN aid placement restrictions to avoid contamination.

12303. Explosive Detection Training Event Planning

1. Key Factors. The planning and execution of an MWD explosive detection event needs to achieve a realistic and effective scenario within the regulatory restrictions that have been established for all Marine Corps functions and for base specific situations. Key factor questions associated with the development task configuration:

a. Training Area - is facility also used for civilian purposes [e.g., school, theater, and hangar] or is facility located on range?

b. Type Of Search Area Event - primarily, will explosive training aid be contained in building or in an open area?

c. Number Of Search Events Within The Training Area - what are regulatory restrictions on distance between events and what is impact of area type on these distances?

d. Route to Training Area - what are the regulatory restrictions on the route from the storage area to the training area?

e. Vehicle Load - what is the regulatory restrictions for the vehicle being utilized to transport the explosive training aids?

2. Table 12-2 provides restrictions as they apply to the above planning factors.

24 FEB 2020

<b>Table 12-2.--Explosive Detection Training Event Planning</b>		
<b>Planning Factor</b>	<b>Restriction [see Notes (1) - (6)]</b>	<b>Reference</b>
<b>Training Area - Public</b>	<p>1. <b>Confined Area</b> [aircraft, building, ship, tunnel/bunker]- Cannot exceed <u>9 lbs. NEW</u> for total aids used in one training event.</p> <p>2. <b>Open Area</b> [road, bridge, general open space] - same as above.</p> <p><b>NOTE: Multiple training events must be separated by at least <u>1/4 mile [1320 feet]</u>.</b></p>	reference (af) [para. 2-2.5.2.b]
<b>Training Area - Range</b>	<ul style="list-style-type: none"> <li>Higher NEW restrictions established by the range control can apply for search area events.</li> <li>Distances between events will be dictated by range control based on the amount of training aid NEW involved.</li> </ul>	Contact Range Control
<b>Route to Training Area</b>	Military installations have designated routes over which explosives can be transported with minimal risk to the population.	Contact the installation safety office for information about <u>approved</u> explosive routes.
<b>Vehicle Load</b>	Each installation has route maps that define explosives transportation restrictions.	Installation Specific Explosives Safety Order/Policy
<p><b>NOTES:</b></p> <p>(1) The Net Explosive Weight (NEW)[see Appendix M for details and planning worksheet], is the criteria used to determine the amount of explosives that meet the restrictions specified in this table.</p> <p>(2) Refer to Appendix D [para. 3] for the definition of "Event". An event is the same as the "Training Exercise" in reference (af).</p> <p>(3) CEAP components can be transported in one vehicle to multiple events, but the NEW amount left at the individual training site cannot exceed the event restriction stated in this table.</p> <p>(4) <b>CEAP and Non-Explosive aid component placement -</b></p> <ul style="list-style-type: none"> <li><b>Clean Components.</b> The <i>like</i> components of clean training aids can be utilized together as a single task aid, but the <i>different</i> components must be at least <u>ten feet</u> from another aid.</li> <li><b>Dirty Components.</b> Dirty aids can be collated together as a single detection event task. Event tasks shall be at least <u>ten feet</u> apart.</li> </ul> <p>(5) Range policy may allow higher event NEW limits for explosive components used in detection events on ranges. Exposing MWD teams to high volume explosive threats is encouraged.</p> <p>(6) Same restrictions apply for night and day qualification events unless installation specific regulations are in effect.</p>		

24 FEB 2020

12304. CEAP Safety. The following precautions must be taken with the CEAP components at the training site to avoid personal injury and environmental impact from the hazardous materials:

1. Personal Protective Equipment (PPE)

a. Personnel handling explosive training aids shall wear disposable latex gloves [food handler type] to ensure that the CEAP components are not contaminated with human and other odors and to prevent absorption into the skin.

b. A new set of gloves should be worn for each different type of component (explosive training aid), except when working with the dirty CEAP when gloves can be reused.

c. Avoid contacting the exterior surface of the storage/transfer boxes with the latex gloves.

d. The amount of explosives handled for qualification purposes will be planned and executed per the restrictions provided in table 12-2.

e. Non-essential personnel not actively involved in training should be evacuated to a minimum of 100 feet from the site of CEAP components.

2. Damaged Training Aid. CEAP components damaged during the training process (e.g., MWD bite is the most common cause) will be placed into a plastic bag and returned to the ASP. If the component contents leak (e.g., emulsion), the impacted soil should be collected and returned with the aid. It is not necessary to contact EOD for an evaluation or disposal of the aid since CEAP components are stable even in damaged condition. The damaged component should be placed inside a separate ammunition container for transporting and temporary storage when necessary. See paragraph 12102.7 for processing unserviceable aids.

3. Dynamite Rotation. Appendix M provides procedures on marking and rotating the CEAP dynamite every 30 calendar days. This activity shall be recorded per example entries shown in the Daily Issue/Return Log as illustrated in figure 12-7.

4. Fire Safety

a. Prior to training, the fire department or centralized dispatch, desk sergeant, and the ESO will be notified of the training location and amount/type of explosives to be used.

b. Fire Symbols. See table 12-3.

c. A fire extinguisher (type B/C) will be readily available in the training site.

d. Smoking is prohibited within 100 feet of the CEAP or its components.

e. CEAP components will not be placed near heat or spark producing items, i.e., electrical wiring, radiators, electric heaters, heating vents, or any other source of potential initiation.

5. Training Area Safety

a. The following items will not be within 100 feet of a CEAP component:

- Blasting caps
- Squibs
- Explosives detonators
- Any type of initiator/device
- Pyrotechnics
- Flame/blast producing devices

b. CEAP components will be in place for the minimum time necessary for required odor dispersion, search, and recovery. Collect explosive training aids immediately after the training period.



c. MWDs will not be allowed to touch/pick up any explosive training aid; additionally, explosive training aids should be planted in a manner where direct MWD contact is mitigated.

d. CEAP components will be kept under constant surveillance.

e. Buried Aid Precautions. Placement must be conducted in accordance with those procedures approved in advance by the base explosives safety and environmental offices as required.

Preferred method is to avoid contact with the earth by placing aids in perforated containers, placed at the desired depth.

6. Signs. Table 12-3 provides samples and placement guidance for signs used in the explosive detection training area.

Table 12-3.--Explosive Detection Training Area Signs		
Image	Type	Sign Placement
	<b>FIRE</b>	Posted around the training site so that they are clearly visible from all avenues of approach used by fire fighters. Size requirement is 24" across the flats per reference (af). <b>NOTE:</b> Black number on orange background
 	<b>WARNING</b>	Posted <u>100 feet</u> from the training area to prevent pedestrian access through around the perimeter. <b>NOTE:</b> White lettering on a red background and includes the language of host country [see second example with Japanese text added].

7. Area Security. When CEAP training is conducted in vehicle parking areas, entrance and exit points to the area will be secured and monitored. The area selected should have the minimal amount of pedestrian/vehicle traffic to reduce disruption of the training evolution.

8. Training Aid Location. Personnel involved in emplacing explosive training aids will record the exact location of each explosive training aid planted on the Detection Event Data Sheet form (MC MWD-1) which in turn is recorded in WDMS.

24 FEB 2020

9. Emergency Planning for Electrical Storms. The following safety procedures apply during the approach of an electrical storm.

a. Pre-training Action. Prior to commencing training, the local military weather service will be contacted for an operational weather report. This report will be used to determine if electrical storms are approaching or expected to be forming in the area. The local training SOP shall define the agreement with the weather service concerning notification of training teams in the event an electrical storm approaches.

b. Restriction. Outdoor training or explosive transport will not be conducted when an electrical storm is within ten miles of the training site per reference (af). As a safety rule: if you see lightning or hear thunder, immediately start the following required action.

c. Required Action. If an electrical storm occurs during training, all outdoor use of the explosive training aids should stop. The ASP should be contacted to ensure they are still operating prior to loading the explosives and returning to the ASP. If the ASP is secured or the risk of being on the road is too high, the CEAP components should be secured using one of the following options [assuming worst case scenario with one CEAP package at 74 lbs. (NEW)]:

(1) Occupied Building w/Lightning Protection. Store in an occupied building that has a lightning protection system that meets current requirements per reference (af). Select a position in the building the furthest possible distance from occupants. Constant armed security shall be maintained at access points to the storage area. These buildings should be identified near the training area in advance by the base ESO.

(2) Unoccupied Building. Store in an unoccupied building. Constant armed security shall be maintained at access points to the building.

(3) Open Area. Position in an open area (away from trees or other structures that might attract lightning) at least 100 feet radius from occupied buildings or personnel when using up to nine pounds of explosive training aids. Constant armed security visual surveillance shall be maintained. When using one CEAP (10-75 lbs.), increase radius to at least 175 feet, and for two CEAPs (76-150 lbs.), use at least a 225 feet

24 FEB 2020

radius. For more details, please see the MWD Personnel Explosive Detection Safety Training brief.

10. Post Training Action. Upon completion of training and prior to departure from the training site, the person in charge will conduct an inventory of all explosive training aids. Two people will verify that all training aids are accounted for and returned to the transport box.

12305. Non-Explosive Training Aid Safety. Chlorate and nitrate oxidizers are hazardous materials and as such the following precautions must be taken to avoid personal or MWD injury when working with the substance on a regular basis:

1. Personnel

a. Avoid direct contact since this can cause irritation to skin; symptoms include redness, itching, and pain. Wear latex gloves when handling oxidizer training aids.

b. Avoid inhalation of the oxidizer odor.

c. Avoid contact with vapors which can cause irritation, redness, and pain to the eyes.

d. Refer to the appropriate chlorate and nitrate MSDS for details on safety precautions.

2. MWD. Avoid having the MWD biting or ingesting the non-explosive training aid since this causes irritation to the gastrointestinal tract. Symptoms may include nausea, vomiting, diarrhea, and abdominal pain. Contact the VCO immediately since death may occur from renal failure, generally in four days. Estimated lethal dose is 15 to 30 grams.

12306. Transportation

1. Restrictions. Explosive training aids will be transported only in government owned or government leased vehicles meeting the criteria under references (aj) and (ak). See table 12-2 for vehicle load restrictions. Non-explosive training aids shall be transported in Government-owned or Government-leased vehicles only. The aids must be contained in the original manufacturer's packaging or a sealed container.

2. Security. A driver and guard (qualified per table 12-1) of a vehicle transporting CEAP components, on and off base, will



adhere to the physical security requirements contained in reference (ag) as they apply to Category 2 items.

### 3. Vehicle Inspection

a. Vehicles will be certified as safe for explosive transportation by a qualified inspector. Depending on the following route situations, the driver will ensure that the required documentation is completed and the vehicle is operated per the references noted:

(1) On-Base Movement of Government Owned Vehicles - complete NAVMC 10627, Vehicle and Equipment Operational Record (Administrative and Tactical Motor Vehicles) Form, or DD 626, Motor Vehicle Inspection (Transporting Hazardous Material) Form, per references (ak) and (al).

(2) Off-Base Movements - complete form DD 626, Motor Vehicle Inspection (Transporting Hazardous Material) per reference (am) [100-185, 200-399].

b. Required emergency response information and references will be available prior to departing the storage area. Placards of the type shown in figure 12-3 must be mounted on all four sides of the vehicle, except the compatibility code is only required on the sign when the vehicle is loaded onto an aircraft or a vessel (reference (am), Part 172.504(g)).



Figure 12-3.-- Placard, Explosive  
\* Class 1.1  
\* Compatibility Code (D)

### 4. Vehicle Safety

a. Each explosive training aid component will be transported in its designated storage container.

b. Explosives will only be transported in the cargo compartment area and will be properly secured with tie-down straps/chains prior to movement of the vehicle per reference (al).

24 FEB 2020

c. Under no circumstances will personnel/MWDs ride in the cargo compartment with explosive training aids.

d. Wheel chocks will be used to block one of the rear wheels (down-hill side) when the vehicle is parked to prevent the vehicle from rolling.

#### 12307. Reporting

1. Unserviceable Components. Make log entries per example in figures 12-7 and 12-8 after processing unserviceable explosive training aids [see paragraph 12102.7].

#### 2. Theft/Loss of Aid

a. Explosive Training Aid. The following action applies for theft or loss of an explosive training aid:

(1) Report immediately to the local office of the Naval Criminal Investigative Service (NCIS).

(2) Notify the issuing ASP per reference (an).

(3) Complete a Missing/Loss/Stolen/Recovered (MLSR) Report per reference (n).

(4) Complete DD 200, Financial Liability Investigation of Property Loss form.

b. Non-Explosive Training Aid. The theft or loss of non-explosive training aids will be reported up the chain-of-command for determination if the amount and value constitute reporting to NCIS under local guidelines.

12308. Physical Inventory. To ensure accountability and condition of explosive and non-explosive training aids, physical inventories shall be conducted per the following procedures:

#### 1. Explosive Training Aids

a. The KM shall conduct semi-annual [April and October] physical inventory of all explosive training aids and prepare a MFR per figure 12-4 with distribution noted at the end of the document [one inventory shall coincide with the annual CEAP turn-in]. Also, he/she shall make a signed entry in the Daily Issue/Return Log per the examples in figure 12-7.

b. The key function of the physical inventory is to reconcile the CEAP on-hand plus the documented DD 1348-1A transfers which should equal the CEAP amount initially issued. Quantity discrepancies are to be processed per paragraph 12307.2.

c. The October inventory will be documented by the end-of-FY Class V(W) Expenditure Report [NAVMC 11381] which will be referenced in the October MFR of figure 12-4.

2. Non-Explosive Training Aids. The KM shall conduct a semi-annual physical inventory, inspection and reconciliation [should coincide with KM inventory of the CEAP] of all non-explosive training aids including separately stored unserviceable aids (aged). The KM shall prepare a MFR per figure 12-4. Also, he/she shall make a signed entry in the Daily Issue/Return Log per the examples in figure 12-8.

12309. Record Keeping

1. Explosive Training Aid Standard Operating Procedure (SOP)

a. Reference (ae) does not apply to this activity, so a lengthy safety management program SOP is not required. However, a written local SOP shall be developed to supplement procedures stated in this chapter. This SOP shall include, but not limited to, the following local specific procedures for the control and use of explosive/non-explosive training aids:

(1) Receiving/returning explosive/non-explosive training aids.

(2) Procurement of non-explosive components.

(3) Personnel training and recording as required per table 12-1.

(4) Storage and security.

(5) Use of drop aids.

(6) Description of key KM/trainer oversight duties for training aids to include timelines and deadline dates as applicable.

(7) Record keeping (where maintained, recording responsibilities, etc.).

(8) Conduct of semi-annual physical inventory.

(9) Disposal of unserviceable aids.

(10) Reporting discrepancies/damage/loss.

(11) Planning guide for explosive detection events (event checklist [see example in figure 12-5], training areas, transportation routes with NEW limitations, suggested tasks, aid placement, etc.).

(12) Construction of quick reference binder for use when obtaining CEAP components to include, but not limited to, explosive vehicle checklist, event checklist, SOP, copy of licenses, CEAP AINs, etc.

(13) Points of contact information.

b. This document is reviewed annually and changed when outdated. The operations officer should sign an annual review letter attached to the SOP if it does not require changes. The current commander must sign or re-sign the SOP when changes are made. This SOP is an integral element in the section operations binder described in Appendix F.

2. Explosive Training Aid Accountability Folder. The KM will maintain an Explosive Training Aid Accountability Folder that contains key documentation relating to the security and custody of explosive/non-explosive training compounds.

a. Figure 12-6 provides an overview of the configuration of the Explosive Training Aid Accountability Folder along with specified documentation retention requirement.

b. Due to the volume of paperwork involved, it is recommended that the following separate folders be maintained:

(1) Active [current FY CEAP](Oct-Sept).

(2) Archive [past two FY periods].

c. Maintain only original copy of DD 1348-1A in the folder.

d. The folder will be safeguarded in a secure area.

e. Correspondence and investigation reports relating to an inventory discrepancy shall be maintained behind the associated inventory report. Divider tabs for each inventory report are recommended.

f. It is the KM's preference as to the most effective combination of folder type to use; e.g., 3-ring binder, multi-pocket folder.

3. Daily Issue/Return Log - Explosive. The KM will maintain a daily issue/return log to record daily transactions involving explosive training aids. This log is intended to record the aids removed from the ASP [or command storage] and encompasses both the clean and dirty CEAP components. The log will be safeguarded in a secure area. This log should be kept in a bound log book, such as NSN 7530-00-286-8363, or equivalent, and prepared per the format and example entries of figure 12-7.

4. Daily Issue/Return Log - Non-Explosive. The KM will maintain a daily issue/return log to record daily transactions involving non-explosive training aids. This log is intended to record the aids removed from the command hazmat locker and encompasses both the clean and dirty aids. The log will be safeguarded in a secure area. This log should be kept in a bound log book, such as NSN 7530-00-286-8363, or equivalent, and prepared per the format and example entries of figure 12-8.

5. CEAP Data Card Form (MC MWD-5). The KM shall ensure that all users receiving CEAP components at the ASP [or command storage] are familiar with procedures to maintain the current contents count for both the CLEAN and DIRTY containers by utilizing the MC MWD-5 worksheet illustrated in Appendix E. This form is located with each container as illustrated in Appendix M and is intended to be a quick reference for the users, ASP technicians and fireman in the case of emergencies. This form is intended to reflect the full component quantity during not-in-use periods and not daily transactions for temporary training use. The KM can also use the Ammunition Magazine Data Card (NAVMC 10765A) if maintaining a separate form on each component is preferred.

**NOTE**

The CEAP data card reflects what quantity of CEAP components is currently in the custody of the MWD section where the Daily Issue/Return log indicates what is temporarily checked out. The CEAP box must contain, at any one time, the last balance amount on the MC MWD-5 less the amount currently issued in the log.

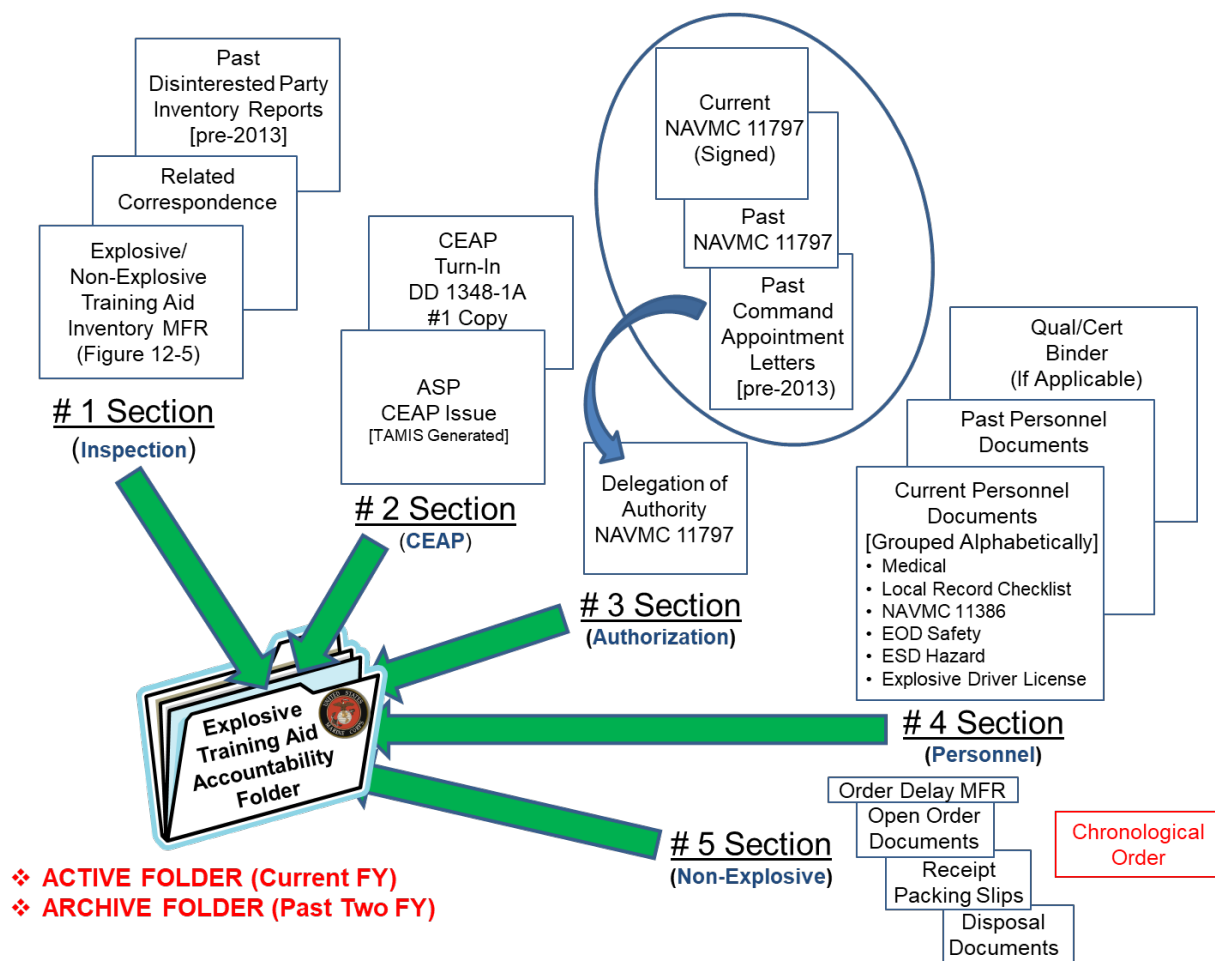

Figure 12-6.--Explosive Training Aid Accountability Folder Configuration

Section 12400 - Training Aids for Deployment

12401. Purpose. This section outlines procedures that apply to acquiring and maintaining explosive/non-explosive training aids while on deployment.

12402. Explosive Training Aids

1. CEAP. The deploying KM should coordinate with MEF G-4 [Ammo] to include CEAP components as part of the combat load to sustain MWD training in-country. The CEAP(s) will be assembled by the in-theater ASP when requested by the using command. The CEAP would be issued from the forward ASP; stored and managed under the same procedures as done at the home base unless the conditions of paragraph 12404 apply. Contact the MWD PM [see Appendix C] to coordinate an increased CEAP authorization in TAMIS if it is required.

2. In-Country Sourcing. Arrange through the command AA&E Officer to coordinate with the EOD unit within the AO to assemble an in-theater explosive training kit from small odor samples of locally recovered explosive devices. The in-theater kit would be stored and managed under the same procedures that apply to the CEAP and returned to EOD at the end of the tour of duty for disposal. The in-theater kit cannot be considered or tracked as the CEAP (no lot numbers for NAR/AIN application).

12403. Non-Explosive Training Aids. Each deploying detachment should assemble a non-explosive training aid kit that consists of the same aid sizes recommended in Appendix N along with sufficient extra oxidizer chemical to refresh the aids in the same manner done at the home base. Oxidizing components can be transported in compliance with the appropriate regulations relating to hazardous materials. It is recommended that first priority be given to locating local sources in the AO or, if possible, have the substances sent via commercial carrier for arrival at location. These aids will be stored and managed by the same procedures as done at the home base.

12404. Expeditionary Explosive Training Aid Storage. During Expeditionary Operations, standard storage containers (see table 12-4), with sand bag or similar barrier to contain an explosion, should be used as the prime means of storage for explosive training aids. Training Aids will not be stored in the same living area occupied by Handlers and MWDs. It is important to prevent desensitizing the MWD to the odor of explosives whether residual on the handlers clothing or residual

24 FEB 2020

in the room. This should not preclude Marines from keeping required ammunition and pyrotechnics for combat operations.

<b>Table 12-4.--Expeditionary Storage Containers</b>			
<b>TAMCN</b>	<b>NSN</b>	<b>Nomenclature</b>	<b>Picture</b>
C4433	8115013540797	Box, Shipping 6x6x8 QUADCON	
C4431	8115013713690	Box, Shipping 4x4x5 PALCON	



**EXAMPLE**

NOTICE OF DELEGATION OF AUTHORITY (DOA) TO REQUEST, APPROVE, AND RECEIVE CLASS V(W)							DATE: 190729
ORGANIZATION RECEIVING SUPPLIES: MCAF/HMX-1 K-9			LOCATION: MCB QUANTICO ASP		AUTHORIZED REPRESENTATIVE(S)		SUPPORTING ACTIVITY: MCB QUANTICO ASP MMQQSO
NAME (LAST, FIRST, MIDDLE INITIAL)	GRADE	REQUEST	AUTHORITY TO:		SIGNATURE	INITIALS	
MASTER, KENNEL, Z.	E-6	Yes	No	Yes			
TRAINER, SAMPLE, A.	E-5	Yes	No	Yes			
<p style="text-align: center;">* PERSONNEL AUTHORIZED TO RECEIVE SECURITY RISK CATEGORY (SRC) ITEMS MUST MEET THE RANK/GRADE REQUIREMENTS OF MCO 5530.14.</p>							
<p style="font-size: small;">AUTHORIZATION BY DODAAC RESPONSIBLE OFFICER</p>							
<p style="font-size: small;">PERSONNEL LISTED ABOVE HAVE PASSED AA&amp;E SCREENING IAW MCO 5530.14.</p>							
<p style="font-size: small;">THIS DELEGATION OF AUTHORITY: <input checked="" type="checkbox"/> SUPERSEDES ALL OTHERS <input type="checkbox"/> IS IN ADDITION TO DOA DATED:</p>							
UNIT IDENTIFICATION CODE M00399	TELEPHONE NUMBER 123-456-7891		SIGNATURE DODAAC				
LAST NAME, FIRST, MIDDLE INITIAL MARINE, IMA, M.	GRADE MAJ		SIGNATURE				

NAVMC Form 11797 (11-11) (EF) (1687)  
FOUO - Privacy sensitive when filled in.

Adobe LiveCycle Designer ES

FOR OFFICIAL USE ONLY

KM -  
TRAINER

Figure 12-2.--Example Delegation of Authority [NAVMC 11797]



[COMMAND LETTER HEAD]

**EXAMPLE**

Date

**MEMORANDUM FOR THE RECORD**

From: Kennel Master

Subj: SEMI-ANNUAL PHYSICAL INVENTORY OF CANINE EXPLOSIVE AND NON-EXPLOSIVE TRAINING AIDS, REPORT OF

Ref: (a) USMC MWD Manual, [MCO ID]

1. Per Reference (a), this report is provided to summarize the results of the physical inventory, inspection and reconciliation of the Military Working Dog (MWD) explosive and non-explosive training aids of this command.

**2. Explosive Training Aids**

- Physical Inventory Date: [Date]
- Explosive Aid Issue/Return Log signed: [Date]

Aid Type	Size	UM	Quantities for Current FY13 CEAP				Dispo DD1348	Reconciliation [Issue must equal Total O/H + Dispo]
			Issue DD1348	On-Hand		Total		
				CLEAN	DIRTY			
C4	1.25	LBS	10	7	2	9	1	OK
CXM	.5	LBS	10	8	2	10	0	OK
DC	10	FT	6	3	3	6	0	1-Clean Short 2"
EM	.5	LBS	18	12	5	17	0	1-Missing
ND	.5	LBS	18	12	5	17	1	OK-see comments
SP	1	LBS	6	3	3	6	0	OK
TF	10	FT	6	4	1	5	1	OK
TNT	.25	LBS	40	30	5	35	5	OK
UN	.5	LBS	18	2	1	3	15	OK-see comments

<b>KEY:</b> C4 = C-4 Block CXM = CXM-7 Block DC = Detonating Cord	EM = Emulsion ND = Nitroglycerin Dynamite SP = Smokeless Powder	TF = Time Fuse TNT = TNT Block UN = Urea Nitrate UM = Unit of Measure
--	---	--

**Additional Comments: Listed by Aid Type**

Aid	Comment
DC	ASP inspected aid and determined shrinkage is cause versus cutting
EM	NCIS investigation in process for missing aid. See case no. 18-200
ND	One dynamite aid found unserviceable during inventory. Turned-in to EOD for disposal.
UN	Aids processed for disposal due to MWD bite. Contacting MWD PM for special authorization to replace aids.

**NOTE**

October report table can be replaced with comment:  
 "All CEAP components accounted for in end-of-FY expenditure report [NAVMC 11381] of [Date]" .

Figure 12-4.--Example Explosive/Non-Explosive Training Aid Physical Inventory Report (1 of 3)

3. Non-Explosive Training Aids

- Physical Inventory Date: [Date]
- Non-Explosive Aid Issue/Return Log signed: [Date]

Ammonium Nitrate (AN) Reconciliation				
(A) Last Inventory Total (Lbs.)	100	(A) Report [Date]		
(B) Total Received Since Last Inventory (Lbs.)	50	(B) 2 Receipts		
(C) Total Disposed Since Last Inventory (Lbs.)	75	(C) 1 Disposal		
(D) Net Amount Required On-Hand (Lbs.)	75	(A)+(B)-(C)		
Status	On-Hand (Lbs)			Remarks
	Clean	Dirty	Total	
(E) AID	25	25	50	2 aids
(F) UNUSED	25	N/A	25	One partial bag
(G) AGED	N/A	0	0	
(H) Total Inventoried (Lbs.)	75	(E)+(F)+(G) Totals		
Amount Discrepancy	0	(H) - (D) [+ Overage] [- Shortage]		
Comments: No discrepancies or inspection issues.				

Potassium Chlorate (PC) Reconciliation				
(A) Last Inventory Total (Gr.)	1950	(A) Report [Date]		
(B) Total Received Since Last Inventory (Gr.)	500	(B) Receipts slips		
(C) Total Disposed Since Last Inventory (Gr.)	1250	(C) Disposal documents		
(D) Net Amount Required On-Hand (Gr.)	1200	(A)+(B)-(C)		
Status	On-Hand (Grams)			Remarks
	Clean	Dirty	Total	
(E) AID	500	510	1010	2 aids, 2 drop
(F) UNUSED	100	N/A	100	One partial bottle
(G) AGED	N/A	30	30	In bucket
(H) Total Inventoried (Gr.)	1140	(E)+(F)+(G) Totals		
Amount Discrepancy	-10	(H) - (D) [+ Overage] [- Shortage]		
Comments: Shortage due to MWD Chester chewing small drop aid and spreading the chemical which could not be recovered. Hander [LCpl Smith] reported lose on 1 Feb 13 and turned-in torn bag.				

Figure 12-4.--Example Explosive/Non-Explosive Training Aid Physical Inventory Report (2 of 3)

Sodium Chlorate (SC) Reconciliation				
(A) Last Inventory Total (Gr.)		2200	(A) Report [Date]	
(B) Total Received Since Last Inventory (Gr.)		1000	(B) Receipts slips	
(C) Total Disposed Since Last Inventory (Gr.)		750	(C) Disposal documents	
(D) Net Amount Required On-Hand (Gr.)		2450	(A)+(B)-(C)	
Status	On-Hand (Grams)			Remarks
	Clean	Dirty	Total	
(E) AID	500	550	1050	3 aids, 5 drop
(F) UNUSED	500	N/A	500	One full bottle
(G) AGED	N/A	650	1050	In bucket
(H) Total Inventoried (Gr.)		2600	(E)+(F)+(G) Totals	
Amount Discrepancy		150	(H) - (D) [+ Overage] [- Shortage]	
<b>Comments:</b> Found one partial filled bottle (150 gr.) in back of closet that was not included in the past inventory count. Chemical too old for use so it was dumped in aged bucket for next disposal.				

\_\_\_\_\_  
(Signature, Kennel Master)

CC: [Next in Chain-of-Command]  
Explosive Training Aid Accountability Folder

Figure 12-4.--Example Explosive/Non-Explosive Training Aid  
Physical Inventory Report (3 of 3)

**EXAMPLE**

[MWD SECTION ADDRESS]

**EXPLOSIVE DETECTION TRAINING CHECK SHEET**

1. **Purpose.** To establish a check sheet of key details associated with the planning and execution of detection training using components of the Canine Explosive Authorization Package (CEAP).

2. **Training Event**

Item	Specifics	Explosive Driver	
Date		Guard	
Location(s)		CEAP Pick-up Times	
Planned Arrival		Arrive	
Planned Departure		Depart	
Site NEW Limit		CEAP Return Times	
Route NEW Limit		Arrive	
Vehicle NEW Limit		Depart	

3. **Pre/Post Event Notifications**

Organization	Phone No.	POC	Time Contacted
ASP			
Vehicle Dispatch			
Base Weather Ctr			
Training Area			
PMD/Fire Dispatch			
Base Safety			
Base Safety Officer			
Armory			

4. **CEAP Requirement**

Aid Type	Size	UM	Aids Required			AID NEW (D)	Total NEW (C) x (D)	Remarks
			CLEAN (A)	DIRTY (B)	Total (C) = (A) + (B)			
C4	1.25	LBS				1.25		
CXM	.5	LBS						
DC	10	FT				.07		
EM	.5	LBS				2.0		
ND	.5	LBS				.5		
SP	1	LBS				1.0		
TF	10	FT				.02		
TNT	.25	LBS				.25		
TOTALS								
KEY: C4 = C-4 Block CXM = CXM-7 Block DC = Detonating Cord			EM = Emulsion ND = Nitroglycerin Dynamite SP = Smokeless Powder			TF = Time Fuse TNT = TNT Block UM = Unit of Measure		

Additional Instructions:

Figure 12-5.--Example Explosive Training Check Sheet

Daily Issue/Return Log – Explosive Aids  
[lined bound book]

RIGHT SIDE

LEFT SIDE

ISSUE										RETURN							
DATE YEAR/MO	TIME	AID TYPE	Clean/Dirty	SIZE	QTY	USER NAME	USER Sign	ASP NAME	ASP Sign	DATE YEAR/MO	TIME	QTY	USER NAME	USER SIGN	ASP NAME	ASP SIGN	REMARKS
EXAMPLE ENTRIES										EXAMPLE ENTRIES							
20130105	N/A	TNT	Clean	1/4 #	40	N/A				20130105	1400	N/A	A.W. Smith	Anthony W. Smith	P.G. Wells	Phil Wells	NEW ISSUE
20130215	0800	TNT	Clean	1/4 #	4	O.K. Troy	O.K. Troy	P.G. Wells	Phil Wells	20090801	1800	1	O.K. Troy	O.K. Troy	P.G. Wells	Phil Wells	Aid put on dirty pallet
20130301	0730	CXM	DIRTY	1/2 #	2	I.R. Marine	I.R. Marine			20130301	1700	2					1-OK 1-DAMAGED
20130301	0730	C4	DIRTY	1-1/2 #	4	I.R. Marine	I.R. Marine			20130301	1700	4					
20130301	1700	CXM	DIRTY	1/2 #	1	I.R. Marine	I.R. Marine	H.C. Bang	H. Chuck Bang	N/A							MWD DAMAGED & turned-in to ASP on DD1348
		INVENTORY CONDUCTED			20130702								Anthony W. Smith				Semi-Annual MFR 20130702
		INVENTORY CONDUCTED			20130915								Thomas E. Grunt				RM Change MFR 20130915
20140104	0900	TNT	CLEAN	1/4 #	30	T.E. Grunt	T.E. Grunt	P.G. Wells	Phil Wells	N/A							Annual Turn-In
		DYNAMITE ROTATED TO "A"				CLEAN/DIRTY							I.R. Marine				

- 1
- 2
- 3
- 4
- 5
- 6
- 7
- 8
- 9

**NOTE: This log is required for all MWD sections with CEAP.**

See next page for description of example log entries and aid type abbreviations.

Figure 12-7.--Daily Issue/Return Log w/Example Entries - Explosive Aids (1 of 2)

**Description of Example Entries by Reference Line Number**

1. KM checks in components of newly issued CEAP.
2. Authorized user receives aid and returns same day with no discrepancies, but aid is put on the DIRTY pallet since it was collocated with other explosives during training.
3. Authorized user receives two good aid and returns one, but the second is damaged by MWD. Note that damaged aid is turned-n on #5.
4. Authorized user takes two different types of aids at same time. Signature blocks can be combined.
5. Damaged aid is removed from CEAP and turned-in to the ASP on a DD1348-1A. Aid was not replaced.
6. KM records conduct of semi-annual physical inventory.
7. New KM records conduct of physical inventory for change of KM.
8. KM turns-in CEAP component for annual replacement cycle. Show number of CLEAN and DIRTY aids turned-in.
9. Authorized user records conducting the monthly dynamite rotation to the "A" position.
<b>ABBREVIATIONS FOR EXPLOSIVE AID TYPES</b>
<b>C4</b> = C-4 Block
<b>CXM</b> = CXM-7
<b>DC</b> = Detonating Cord
<b>EM</b> = Emulsion
<b>ND</b> = Nitroglycerin Dynamite
<b>SP</b> = Smokeless Powder
<b>TF</b> = Time Fuse
<b>TNT</b> = TNT Block
<b>UN</b> = Urea Nitrate

Figure 12-7.--Daily Issue/Return Log w/Example Entries  
- Explosive Aids (2 of 2)

Daily Issue/Return Log – Non-Explosive Aids

[lined bound book]

LEFT SIDE

RIGHT SIDE

ISSUE							RETURN				
DATE YYYYMMDD	TIME	AID TYPE	Dirty/ Clean	SIZE	QTY	USER NAME	USER INIT	KM/TRG INIT	REMARKS		
EXAMPLE ENTRIES											
N/A	N/A	SC	CLEAN	500g	N/A					NEW CONSTRUCTED AID	
20130201	1400	AN	DIRTY	15 lbs	1	A.J. Troy				OK	
20130401	1100	PC	CLEAN	500g	1	T.A. Marine	EM			DAMAGED by MWD Aggress- WILL REPLACE	
20130725	0900	SC	DIRTY	500g	1	L.E. Watkins	AWS			Mission Use - expect back 20130810	
20130915	1400	PC	CLEAN	500g	2	F.W. EDGE	FWE			DEPLOYED - disposal in ADA 20140301	
EXAMPLE ENTRIES											
INVENTORY CONDUCTED 20130615										Semi Annual MFR 20130615	
ALL AIDS REFRESHED-20131215											
INVENTORY CONDUCTED 20140115											KM Change MFR 20140115

- 1
- 2
- 3
- 4
- 5
- 6
- 7
- 8

NOTE: This log is required for all MWD sections that have non-explosive aids.

See next page for description of example log entries and aid type abbreviations.

Figure 12-8.--Daily Issue/Return Log w/Example Entries  
- Non-Explosive Aids (1 of 2)



**Description of Example Entries by Reference Line Number**

1. KM checks in newly constructed non-explosive training aid.
2. Authorized user receives aid and returns it same day with no discrepancies.
3. Authorized user receives good aid and returns it damaged due to aggressive MWD action during training. Aid is processed for disposal and new aid constructed [new entry required].
4. KM issues aid to authorized user who is going on short term mission. Expected return date is shown in remarks. On return, the right side of the log is completed.
5. KM issues aid to authorized user who is deploying with operational forces. Return section is for zero aids since they were disposed of in the AOA.
6. KM records conduct of semi-annual physical inventory of all non-explosive training aids.
7. Trainer records refreshing all non-explosive training aids.
8. New KM records conduct of physical inventory for change of KM.
<b>ABBREVIATIONS FOR NON-EXPLOSIVE AID TYPES</b>
<b>AN</b> = Ammonium Nitrate
<b>PC</b> = Potassium Chlorate
<b>SC</b> = Sodium Chlorate

Figure 12-8.--Daily Issue/Return Log w/Example Entries  
- Non-Explosive Aids (2 of 2)

**APPENDIX A**

Glossary of Terms and Abbreviations

Abbreviation	Description
AA&E	Arms, Ammunition & Explosives
AAR	After Action Report
ADAL	Addition/Alteration
ADC PP&O (Security)	Assistant Deputy Commandant, PP&O (Security)
A-E	Architectural/Engineering Firm
AF	Air Force
AFI	Air Force Instruction
AFMES/FORTOX/MWD	Armed Forces Medical Examiner System, Division of Forensic Toxicology/MWD Laboratory
AFMES	see AFMES/FORTOX/MWD
AFSFC	Air Force Security Forces Center
AIN	Ammunition Information Notice
AO	Area of Operations
ASP	Ammunition Supply Point
ASR	Alternate Supply Route
AT/FP	Anti-Terrorism/Force Protection
BATF&E	Bureau Of Alcohol, Tobacco, Firearms and Explosives
BCE	Base Civil Engineer
BEQ	Bachelor Enlisted Quarters
BIC	Billet Identification Code
BOQ	Bachelor Officer Quarters
C&K	Cordon & Knock
CAC	Common Access Card
CAR	Command Authorized Request
CARVI	Command Authorized Random Vehicle Inspection
CASS	Command Authorized Search & Seizure
CAVI	Command Authorized Vehicle Inspection
CDSK	Canine Drug Scent Kit
CEAP	Canine Explosive Authorization Package
Cert	Certification
CETASM	Canine Explosive Training Aid Storage Magazine
CFR	Code of Federal Regulations
CG	Commanding General
CGIP	Commanding General's Inspection Program
CI	Civilian Internee
CIIC	Controlled Inventory Item Code

Abbreviation	Description
CIP	Command Inspection Program
CLEOC	Consolidated Law Enforcement Operations Center
CMC	Commandant of the Marine Corps
CMR	Controlled Material Record
CO	Commanding Officer
COB	Change of Behavior
COCOM	Combatant Commander
CONUS	Continental United States
COVI	Commanding Officer Vehicle Inspection
CP	Camp
CTD	Combat Tracker Dog
CVI	Commercial Vehicle Inspection
CWD	Contract Working Dog
DBA	Data Base Administrator
DC, PP&O	Deputy Commandant, Plans, Policy & Operations
DDD	Drug Detector Dog
DEA	Drug Enforcement Agency
DoA	Department of the Army
DoD	Department of Defense
DODIC	Department of Defense Identification Code
DoD ID	Department of Defense Identification number (formerly called EDIPI)
DoN	Department of the Navy
DoS	Department of State
DTS	Defense Travel System
e.g.	Means "for example" and is an incomplete list.
E-Collar	Electric Collar
ECP	Entry Control Point
EDD	Explosive Detector Dog
EDIPI	Electronic Data Interchange Personal Identifier
EOD	Explosive Ordnance Disposal
EOF	Escalation of Force
EOL	End of Leash
EPW	Enemy Prisoner of War
ERD	Estimated Release Date
ESI	Explosives Safety Inspection
ESO	Explosives Safety Officer
ESSA	Explosives Safety Self-Assessment
°F	Degrees Fahrenheit
FEQ	Field Evaluation Questionnaire
FLOTUS	First Lady of the United States

Abbreviation	Description
FOC	Full Operating Capability
FPOTUS	Former POTUS
FT	Foot
FY	Fiscal Year
GBL	Government Bill of Lading
GOV	Government Owned Vehicle
GS	Government Service
GSA	Government Services Administration
GTCC	Government Travel Credit Card
GTR	Government Transportation Request
H&S Co.	Headquarters and Support Company
HC/D	Hazard Class/Division
HLS	Homeland Security
HME	Homemade Explosives
HQMC	Headquarters Marine Corps
HRP	High Risk Personnel
HRT	High Risk Target
HVAC	Heating, Ventilation, Air Conditioning
i.e.	Means "that is" and is a complete list [whatever follows i.e., includes everything]
ICP	Inventory Control Points [Inventory Management] Initial Commencement Point [Tracker Training]
ICR	Incident/Complaint Report
IDS	Intrusion Detection System
IED	Improvised Explosive Device
IGMC	Inspector General of the Marine Corps
IT	Information Technology
IWW	Ideal Working Weight
JBSA-Lackland	Joint Base San Antonio-Lackland, TX [formerly Lackland Air Force Base]
JSMWDC	Joint Service Military Working Dog Committee
KM	Kennel Master
LAFB	Lackland Air Force Base [old identifier still used on forms originating from the 341 TRS, JBSA-Lackland]
LAN	Local Area Network
LE	Law Enforcement
LE Bn	Law Enforcement Battalion
LEA	Law Enforcement Agencies
LED	Light Emitting Diode
LP	Listening Post
MAGTF	Marine Air-Ground Task Force
MARADMIN	Marine Administrative Message

Abbreviation	Description
MARSOC	Marine Corps Forces Special Operations Command
MAAT	Mission Assurance Assessment Team
MAJCOM	Major Command
MATCU	Military Air Traffic Coordinating Unit
MC	Marine Corps
MCPD	Marine Corps Police Department
MCSC	Marine Corps Systems Command
Med Cat	Medical Deployment Category
MEF	Marine Expeditionary Force
MET	Mission Essential Task
METL	Mission Essential Task List
MEVA	Mission Essential Vulnerable Area
MFE	MWD Field Element
MFR	Memorandum for the Record
MIA	Missing-In-Action
MILCON	Military Construction
Min	Minimum
MOL	Marine-on-Line
MOS	Military Occupational Specialty
MOU	Memorandum of Understanding
MP	Military Police
MSC	Major Subordinate Commander
MSDS	Material Safety Data Sheet
MSOSG	Marine Special Operations Support Group
MSR	Main Supply Route
MTMC	Military Traffic Management Command
MWD	Military Working Dog
MWD PM	Military Working Dog Program Manager
MWDEA	MWD Executive Agent
NAR	Notice of Ammunition Reclassification
NAVMC	Navy-Marine Corps
NCIS	Naval Criminal Investigative Service
NCOIC	Non-Commissioned Officer-In-Charge
ND	Nitroglycerin Dynamite
NEW	Net Explosive Weight
NOTAL	Not To All
NSN	National Stock Number
NSSE	National Special Security Events
NVD	Night Vision Device
OCONUS	Outside Continental United States
OJT	On-the-Job Training
OMPF	Official Military Personnel File
OP	Observation Post

Abbreviation	Description
OPS	Operations
OTP	Optimum Training Plan
PDDD	Patrol Drug Detector Dog
PEDD	Patrol Explosive Detector Dog
PASS	Permissive Authorization of Search and Seizure
PC	Police Chief
PCA	Permanent Change of Assignment
PCS	Permanent Change of Station
PD	Patrol Dog
PM	Provost Marshal
PM AMMO	Program Manager Ammunition
PMEL	Precision Measurement Equipment Lab
PMO	Provost Marshal Office
POC	Point of Contact
POTUS	President of the United States
POV	Privately Owned Vehicle
PP&O	Plans, Policies & Operations
PPE	Personal Protective Equipment
PS	Security Division
Qual/Cert	Qualification/Certification Program
R&D	Research & Development
RAM	Random Anti-Terrorism Measure
RFF	Request for Forces
RFI	Ready for Issue
RO	Responsible Officer
ROE	Rules Of Engagement
ROICC	Resident Officer-In-Charge of Construction
ROMO	Range of Military Operations
SAAR	Security Authorization Access Request
SE	Supporting Establishment
SF	Square Foot or Security Forces
SJA	Staff Judge Advocate
SME	Subject Matter Expert
SNAP	Quick Search
SOFA	Status of Forces Agreements
SOI	School of Infantry
SOP	Standard Operating Procedures
SoS	Secretary of State
SSD	Specialized Search Dog
STC	Sound Transmission Class
SupO	Supply Officer
T/E	Table of Equipment
T/O	Table of Organization

Abbreviation	Description
T/O&E	Table of Organization and Equipment
TAD	Temporary Assigned Duty
TAMCN	Table of Authorized Material Control Number
TAMIS	Total Ammunition Management Information System
TDY	Temporary Duty
TECOM	Training & Education Command
TFSMS	Total Force Structure Management System
TOECR	Table of Organization and Equipment Change Request
TRS	U.S. Air Force 341 Training Squadron
TVC	Training, Validation and Certification
UFAN	Unique Federal Agency Number
USAF	United States Air Force
USCG	United States Coast Guard
USSS	United States Secret Service
Val	Validate
VCO	Veterinary Corps Officer
VCP	Vehicle Control Point
VCT	Vinyl Composition Tile
VIP	Very Important Person
VPOTUS	Vice President of the United States
VTF	Veterinary Treatment Facility
WDMS	Working Dog Management System
WPDS	Written Policy Directive System

**APPENDIX B**

Military Working Dog (MWD) Team Performance

**Table of Contents**

<u>IDENTIFICATION</u>	<u>TITLE</u>	<u>PAGE</u>
1	Purpose.....	B-1
2	Introduction.....	B-1
3	Scope.....	B-2
<b>TABLES</b>		
B-1	Tab Chart.....	B-2
<b>TABS</b>		
B1	MWD Basic Skills.....	B1-1
B2	MWD Patrol.....	B2-1
B3	MWD Detect.....	B3-1

**NOTE:**  
"Team" applies to both military and civilian police unless noted.

1. Purpose. To establish performance parameters for all Marine Corps Military Working Dog (MWD) teams. These requirements will provide quantified threshold and objective key performance parameters (KPP) that are consistent with those defined in the Joint Service Capabilities Production Document (CPD) for the family of MWDs.

2. Introduction. The MWD Executive Agent (U.S. Air Force) is responsible for defining the desired characteristics [temperament, size, age, fitness, boldness, bite, etc.] of each MWD capability and to obtain suitable candidate dogs for MWD training. Each MWD is trained at an authorized DoD school where it is evaluated and certified that the dog can perform to the threshold performance standard. This basic threshold requirement has been set as the Marine Corps "validation" performance parameter at which the MWD is capable, with a qualified handler, to support the majority of the operational and non-operational assignments. Where enhanced skill level is desired, the MWD Program Manager has established the "Objective" performance parameter. Upon receiving a new MWD from initial training and assigning a handler, the kennel master shall determine through the validation process if the MWD team can achieve the threshold parameters and report the results on the Field Evaluation Questionnaire (FEQ) located in WDMS. All required objective odors will be imprinted [see Appendix G]



prior to conducting the validation per Appendix D. Once validated, the MWD training schedule will be focused on further enhancing the MWD team skills to achieve the stated objective parameters.

**IMPORTANT:**

1. Appendix D provides qualification standards and guidelines to be used for the purpose of determining if an MWD team can **meet the "Threshold" performance parameters** defined in this appendix (unless otherwise upgraded to a higher level within the standard). The intent is that all MWD teams are evaluated and reported in a consistent basis throughout the Corps.
2. **Evaluation at "Objective" levels is a kennel master's decision based on local operational requirements but failure to qualify above the threshold must not be reported as a failure of a team validation.**

3. Scope. Table B-1 defines appendix tabs that provide performance requirements by MWD capability and types:

<b>Table B-1.--Tab Chart</b>		
<b>TAB</b>	<b>CAPABILITY</b>	<b>MWD TYPE</b>
<b>B-1</b>	<b>MWD Basic Skills</b>	All
	Table B1-1 Obedience	
	Table B1-2 Agility	
	Table B1-3 Distraction	
<b>B-2</b>	<b>MWD Patrol</b>	PDDD
	Table B2-1 Patrol PEDD/PDDD	PEDD
<b>B-3</b>	<b>MWD Detect</b>	All
	Table B3-1 Detection	
	Table B3-2 Odors	
	Table B3-3 Search	
	Table B3-4 Commands	

**NOTE:**

In the tables to follow, the term "**T=O**" means THRESHOLD PERFORMANCE EQUALS OBJECTIVE PERFORMANCE.

**TAB B1**

Military Working Dog (MWD) Basic Skills

**Table of Contents**

<u>IDENTIFICATION</u>	<u>TITLE</u>	<u>PAGE</u>
<b>TABLES</b>		
B1-1	Obedience.....	B1-1
B1-2	Agility.....	B1-2
B1-3	Distraction.....	B1-3

<b>Table B1-1.--Obedience</b>		
<b>All MWDs except SSD will be on 6-foot leash</b>		
<b>Desired Capability</b>	<b>Production Threshold</b>	<b>Production Objective</b>
<b>Obedience</b>	MWD must be capable of successfully executing command with no more than <u>one</u> correction per command for a minimum of <u>five</u> seconds.	T=0
<b>HEEL</b>	MWD on both visual cues and verbal commands separately: At the command "HEEL" MWD assumes the proper heel position and remains at this position while the handler conducts walking movements. When handler stops, MWD is commanded "HEEL". Each facing movement can have a command. MWD sits at handler left side at Heel command.	Off-Leash
<b>DOWN from Heel</b>	MWD on both visual cues and verbal commands, separately: At the command "DOWN", MWD assumes the down position on left side of handler upon command while maintaining correct position at heel without radical shifts of position.	Off-Leash
<b>DOWN [at end of leash]</b>	MWD on both visual cues and verbal commands, separately: At the command "DOWN", MWD sitting at end of six-foot leash assumes the down position without pronounced "creeping" (more than six inches) towards the handler.	Off-Leash
<b>SIT [at end of leash]</b>	MWD on both visual cues and verbal commands, separately: At the command "SIT", MWD at down position at end of six-foot leash assumes the sit position without pronounced "creeping" (six inches) towards the handler.	Off-Leash
<b>STAY</b>	MWD on both visual cues and verbal commands, separately: At the command "STAY", MWD maintains last commanded position.	Off-Leash

<b>Table B1-1.--Obedience</b>		
<b>All MWDs except SSD will be on 6-foot leash</b>		
<b>Desired Capability</b>	<b>Production Threshold</b>	<b>Production Objective</b>
<b>Recall to Heel</b>	MWD on both visual cues and verbal commands separately: At the command "HEEL" MWD returns to the heel position on the handler's left side from the end of a 6-foot leash.	Off-Leash
<b>HUP</b>	MWD at the command "HUP" (with visual point, and verbal command), MWD maneuvers (jumps, raises, elevates, or positions himself) up to designated elevation.	Off-Leash
<b>OUT</b>	MWD on verbal command "OUT", MWD effectively releases the primary reward object without excessive force required by the handler. Within two minutes of given command.	Five seconds or less
<b>SSD only</b>	The following commands will be conducted at 75 meters: "DOWN" "SIT" "STAY" Recall to "HEEL"	200 meters

<b>Table B1-2.--Agility</b>		
<b>(Common to All MWDs)</b>		
<b>Desired Capability</b>	<b>Production Threshold</b>	<b>Production Objective</b>
Obstacle Course (Drop leash)  <b>Only SSD off-leash</b>	While using controlled commands, MWD must successfully negotiate the obstacle course with no more than <u>one correction per obstacle</u> . The standardized course [below] for <u>all</u> MWDs, and responding to "HUP" command. <ul style="list-style-type: none"> <li>• Dog-walk</li> <li>• Stairs/steps</li> <li>• A-Frame</li> <li>• Window hurdle</li> <li>• Three hurdle</li> <li>• One tunnel</li> <li>• Three barrels</li> </ul> As defined in Appendix L	T=0

24 FEB 2020

<b>Table B1-3.--Distraction</b> <b>[All dogs except SSD will be on six-foot leash]</b>		
<b>Desired Capability</b>	<b>Production Threshold</b>	<b>Production Objective</b>
Animal/People/ Noise	MWD will remain focused on task during obedience/detection regardless of movement of wild or domesticated animals, people or vehicles, noise (50 cal./IED blast simulator), and whatever occurs in the certification/evaluation environment.	T=0
Neutral Party Gunfire	MWD does not become handler aggressive, cower without recovery or flee when a disinterested party fires at following intervals from the handler: (4) rounds - 18 meters (4) rounds - 4 meters (2) rounds - 2 meters	T=0
Handler Gunfire	MWD does not become handler aggressive, cower without recovery or flee when the handler fires 10 rounds.	T=0
<b>CTD additional capabilities</b>	During tracking test, evaluator will fire two rounds during the track test from 25-100 meters away. MWD must recover and continue to track.	T=0
	During testing, the handler will fire two rounds during the evaluation; the MWD must recover/continue to work.	T=0

**TAB B2**

Military Working Dog (MWD) Patrol

**Table of Contents**

**IDENTIFICATION**

**TITLE**

**PAGE**

**TABLES**

B2-1 Patrol PEDD/PDDD..... B2-1

<b>Table B2-1.--Patrol PEDD/PDDD</b>		
<b>Desired Capability</b>	<b>Production Threshold</b>	<b>Production Objective</b>
Bite Correct	Bite and hold for at least 10 seconds or release upon command.	Full mouth bite and release upon command
Field Interview On-Leash	MWD remains in Heel, Sit or Down position while suspect approaches in a neutral manner 2-3 meters.	T=0
Pursuit (Attack) Off-Leash	At the command "GET'EM", the MWD must pursue a minimum of 25 meters, bite and hold. <b>NOTE:</b> 341 TRS trains & certifies MWD to bite right arm so decoy wears only bite sleeve.	MWD trained to bite most accessible part of decoy wearing bite suit
Stand-Off Off-Leash	On command of "OUT" the MWD will cease pursuit.	T=0
Search Off-Leash	MWD must remain in guard position while handler searches suspect.	T=0
Building Search On-Leash	The MWD will locate a hidden suspect and perform any one or a combination of the following: scratching, biting, barking, jumping, or stop and stare (cannot be same as response for drug or explosive detection).	Off-Leash
Escort On-Leash	MWD in the heel position escorts suspect for a distance of up to 25 meters.	T=0
Search and Re-Attack Off-Leash	MWD will attack on sudden/aggressive movement of suspect without additional commands from handler.	T=0
Scout	Train on all, but certify MWD on <u>one</u> of the three scouts:	Validate <u>all</u> scouts
Sight	MWD will visually locate a suspect at a distance of 30 meters.	100 meters
Scent	MWD will locate using scent to locate a suspect at a distance of 50 meters.	T=0
Sound	MWD will use sound to locate a suspect at a distance of 30 meters.	T=0

**TAB B3**

Military Working Dog (MWD) Detect

**Table of Contents**

<u>IDENTIFICATION</u>	<u>TITLE</u>	<u>PAGE</u>
<b>TABLES</b>		
B3-1	Detection.....	B3-1
B3-2	Odors.....	B3-1
B3-3	Search.....	B3-2
B3-4	Commands.....	B3-5

<b>Table B3-1.--Detection (As Specified)</b>		
<b>Desired Capability</b>	<b>Production Threshold*</b>	<b>Production Objective</b>
<b>False Response</b>	No more than two false responses during qualification.	Zero false responses
<b>Detection</b>		
--PEDD/SSD/EDD	95% explosives odor tasks detected [total positive responses/total trials]	T=0
--PDDD/DDD	90% drug odor tasks detected [total positive responses/total trials]	T=0
--CTD/PEDD/PDDD	100% of all quarry found	T=0
<b>*NOTE:</b> USMC calculates these thresholds in WDMS using "total trials." The Family of MWDs CPD uses "total number of training aids planted."		

<b>Table B3-2.--Odors (Common to all MWDs unless otherwise noted)</b>		
<b>Desired Capability</b>	<b>Production Threshold*</b>	<b>Production Objective</b>
<b>EDD/PEDD/SSD Odors</b>		
Ammonium Nitrate	1 to 4 lbs	T=0
C-4	.00088 oz to 3¼ lbs	T=0
Det Cord (PETN)	1 to 30 feet	T=0
Emulsion (Blasting Agent)	½ to 3 lbs	T=0
Nitroglycerin Dynamite (ND)	Not imprinted at 341 TRS	<b>USMC Required</b>
Potassium Chlorate	1 to 4 lbs	T=0
Smokeless Powder	1 to 2 lbs	T=0
Sodium Chlorate	1 to 4 lbs	T=0
Time Fuse	Not imprinted at 341 TRS	<b>USMC Required</b>
TNT	.00088 oz to 3 lbs	T=0

24 FEB 2020

<b>Table B3-2.--Odors</b> (Common to all MWDs unless otherwise noted)		
<b>Desired Capability</b>	<b>Production Threshold*</b>	<b>Production Objective</b>
<b>PDDD/DDD Odors</b>		
Cocaine	1 to 17 grams	T=0
Heroin	1 to 14 grams	T=0
Marijuana	3 to 116 grams	T=0
MDMA	3 to 9 grams	T=0
Methamphetamine	2 to 20 grams	T=0
<b>CTD/PEDD/PDDD</b>		
Human Odor	Recognizes human odor [P-any][CTD-specific] and exhibits a change in behavior	T=0
<b>*NOTE:</b> The LAFB 375 form is the source document for the types and amounts of odor that an MWD was trained on at the 341 TRS.		

<b>Table B3-3.--Search</b>		
<b>Desired Capability</b>	<b>Production Threshold</b>	<b>Production Objective</b>
Height/Depth	MWD must qualify on odors hidden from view at heights from zero to six feet, and depths from zero to three feet.	T=0
[PEDD/SSD] Below ground	No certified capability from 341 TRS. Buried no more than 3 inches below ground.	6 to 12 inches
Substance Set Time	MWD to detect target odors stored, at a minimum of 45-minute set time from last aid planted.	T=0
<b>Locations (except SSD and CTD)</b>		
Aircraft	Search both interior and exterior 360 degrees and all accessible internal areas.	T=0
Baggage	Minimum 20 pieces.	T=0
Open Area	50 x 100 meters with buried aids with a minimum of two disturbed holes with at least one being blank.	200 x 200 meters with buried aids with a minimum of five disturbed holes with at least three being blank.
Buildings Barracks	Minimum 15 rooms.	T=0

<b>Table B3-3.--Search</b>		
<b>Desired Capability</b>	<b>Production Threshold</b>	<b>Production Objective</b>
Theater/Warehouse	Minimum 3000 Square feet	9000 Square feet
Vehicle	Minimum 25 vehicles of variable sizes	100 vehicles
<b>SSD off-leash</b> (locations) Buildings Barracks	Interior/exterior, minimum 15 rooms.	T=0
Open Areas	Minimum 200 x 200 meters with buried aids with a minimum of two disturbed holes with at least one being blank. Handler must maintain 30 meters standoff from SSD.	O = Minimum of five disturbed holes with at least three being blank.
Route	Minimum of 200 meters, with buried aids with a minimum of two disturbed holes with at least one being blank. Handler must clear 75 meters regardless of technique while maintaining line of sight. Must clear at least one vehicle inserted within the route clearance event. Vehicle is used as a distracter.	O = Buried aids with a minimum of five disturbed holes. Handler must clear 100 meters.
Vehicles Single Vehicle	Conduct point-to-point search of a single vehicle located at least 150 meters from start point with a maximum of three minutes to direct the SSD to the vehicle and complete the search.	T=0
Multiple Vehicle	Conduct from the start point to vehicle a minimum of 75 meters, minimum five vehicles of variable sizes with a minimum distance of two meters between vehicles, maximum search time of five minutes.	O=15 vehicles, 10 minutes



<b>Table B3-3.--Search</b>				
<b>Desired Capability</b>	<b>Production Threshold</b>		<b>Production Objective</b>	
<b>CTD Only</b>				
<b>Track Characteristics /Type</b>	<b>Rural</b>	<b>Urban</b>	<b>Rural</b>	<b>Urban</b>
Track Set Time	0.5 hr (Min) 2 hrs (Max)	0.5 hr (Min) 2 hr (Max)	T=0	T=0
Track Duration	1 hr (Max)	0.5 hr (Max)	T=0	T=0
Distance (meters)	1000 to 1600	300 to 400	T=0	400 to 800
Obstacles	2 (min)	1 (Min)	T=0	T=0
Deliberate Movements Turns During Track	4 to 7	1 to 2	T=0	T=0
Cross Tracks	Train	Train	1 (Min)	1(Min)
Night Event	Train	Train	1 (Min)	1 (Min)
<b>Methods</b>				
<b>PEDD/EDD/PDDD/DDD</b> (All on-leash)	When given the command "SEEK" the MWD will initiate odor search.		Off-Leash	
SSD (off-leash)				
Scan (Free)				
Detailed (Systematic)	When given the command "SEEK" the MWD will follow hand presentations to a specific point and initiate odor search.		Off-Leash	
<b>SSD Only</b>  Verging	Send the MWD forward on the left side of the roadway until it reaches the desired distance, then recall the dog. Cross to the right side, and then send the MWD forward on the right side of roadway. Move forward with the MWD 25-75 percent of that distance and continue.		T=0	

<b>Table B3-3.--Search</b>		
<b>Desired Capability</b>	<b>Production Threshold</b>	<b>Production Objective</b>
Box	Send the MWD forward on left side of the roadway until it reaches the desired distance. Have the MWD cross the road to the right side, and then recall it. Move forward with the MWD 25-75 percent of that distance and continue. MWD works approximately 30 meters in front of the handler working left and right perpendicular to the handler's direction of travel. MWD can search/travel 30-50 meters left and right in front of the handler searching/hunting for odors.	T=O
Quartering		T=O
Response	Unassisted, uncued, or conditioned final response as close as possible to odor source (within two meters unless blocked). The MWD's final response may include behaviors such as stop and stare, sit, or down (cannot be the same as patrol response).	O = Accepted final response as recorded on LAFB 375.

<b>Table B3-4.--Commands</b>		
<b>Desired Capability</b>	<b>Production Threshold</b>	<b>Production Objective</b>
<b>SEEK</b> PEDD/PDDD/DDD/EDD (On-Leash) SSD (Off-Leash)	On command "SEEK", MWD will initiate explosive/drug odor search.	T=O
<b>FIND'EM</b>  CTD	On the command "FIND'EM", MWD will start track from the human scent origin.	T=O
PEDD/PDDD (On-Leash)	On the command "FIND'EM", MWD will begin to locate the target via sight scent or sound.	T=O
<b>GET'EM</b>  PEDD/PDDD	When commanded "GET'EM", MWD will bite and hold.	T=O

Table B3-4.--Commands		
Desired Capability	Production Threshold	Production Objective
OUT PEDD/PDDD	At the command "OUT", MWD will release a bite on a stationary decoy/suspect. At least two meters from the MWD the handler may use a preparatory command (e.g., MWD name, as in "Tanja, OUT") as well as one correction (e.g., "NO", "OUT").	T=0
Directional  BACK* LEFT RIGHT         HERE*         YES (Urgent Recall)	<b>SSD off-leash only</b>  <b>Directional Command Test</b> [no aids]: Qualify MWD on both visual and verbal commands simultaneously. No more than three corrections per command during event without radios or E-collar. Handler remains within a 10 meters diameter circle  On command of "BACK", the MWD must move forward a minimum of 75 meters. The MWD must follow commands of "LEFT" or "RIGHT" as indicated by the handler, 30 meters perpendicular to original direction then 60 meters in the opposite direction indicated making a "T".  On the command "HERE" MWD returns from distance no less than 75 meters within arm's length of handler.  MWD leaves area and immediately returns to handler whether on odor or not, even if the MWD has already responded to that odor.	Off-Leash All MWDs  On command of "BACK", the MWD must move forward a minimum of 200 meters. The MWD must follow commands of "LEFT" or "RIGHT" as indicated by the handler, 50 meters perpendicular to original direction then 100 meters in the opposite direction indicated making a "T".  On the command "HERE" MWD returns from distance no less than 200 meters within arm's length of handler.  T=0
*NOTE: The commands "BACK" and "HERE" are currently used per reference (ao). However, the Family of MWDs CPD uses "FORWARD" and "COME" instead.		

**APPENDIX C**

Guide To Communications With Military Working Dog (MWD) PM

**Table of Contents**

<u>IDENTIFICATION</u>	<u>TITLE</u>	<u>PAGE</u>
<b>PARAGRAPH</b>		
1	Purpose.....	C-1
2	Introduction.....	C-1
3	Communication Media.....	C-1
4	Submission Process.....	C-1
<b>TABLES</b>		
C-1	MWD Office Point-of-Contact Information.....	C-2
C-2	Communications Media.....	C-2
C-3	Submission and Inquiry Routing Table.	C-3

1. Purpose. This appendix provides guidelines for effective communication with the office of the Marine Corps Military Working Dog (MWD) Program Manager (PM).
2. Introduction. The MWD Program office consists of several staff members located at multiple sites as defined in table C-1. Each staff member has defined responsibilities for ensuring that the MWD community is supported in a wide range of MWD related areas, to include, but not limited to, organizational structure development, MWD sourcing and disposition, personnel training, team qualification standards, MWD employment policy, and facilities/equipment planning. In the interest of achieving a streamlined business process that is responsive to MWD section needs, each kennel master must have a good working knowledge of and comply with the guidelines provided in this appendix as they supplement the policies and procedures of this Manual.
3. Communication Media. Communications with the MWD Program office will be accomplished utilizing one of the media in table C-2 which range in level of formality based on the importance of the topic and requirement for written verification of a requirement.
4. Submission Process. Depending on the nature of the submission or inquiry as identified in table C-3, initiating installation or operating force command shall direct the required information to the points-of-contact (POC) via the appropriate communication media (identified in table C-2).

Additional information relating to follow-up action is provided in the notes of table C-3.

<b>Table C-1.--MWD Office Point-of-Contact Information</b>			
<b>ID</b>	<b>Staff</b>	<b>Mailing Address</b>	<b>Phone</b>
<b>PM</b>	<b>Program Manager</b>	Commandant of the Marine Corps Headquarters, U.S. Marine Corps Security Division (PS), Room #4A324 3000 Marine Corps, Pentagon Washington, DC 20350-3000	(Comm) 703-692-4250 (DSN) 222-4250
<b>DPM</b>	<b>Dep. PM</b>	Headquarters, U.S. Marine Corps Security Division (PS) PSL Military Working Dog (MWD) Dep. PM 755 S. Courthouse Road Bldg. #2, Suite 2000 Arlington, VA 22204-2478	(Comm) 703-604-4254 (DSN) 664-4254
<b>OM</b>	<b>Ops Manager</b>	Operations Manager, USMC MWD Program 1220 Truemper Street, Room 338 Joint Base San Antonio-Lackland, TX 78236	(Comm) 210-671-3583 (DSN) 473-3583
<b>PC</b>	<b>Program Chief</b>	Headquarters, U.S. Marine Corps Security Division (PS) PSL Military Working Dog (MWD) Program Chief 755 S. Courthouse Road Bldg. #2, Suite 2000 Arlington, VA 22204-2478	(Comm) 703-604-0404 (DSN) 664-0404

<b>Table C-2.--Communication Media</b>		
<b>ID</b>	<b>Media</b>	<b>Routing</b>
<b>A</b>	Command Letter - signed by PM/PC or commanding officer over MWD section.	Up the Chain-of-Command (1)
<b>B</b>	Command Letter - signed from Kennel Master	Direct (1)
<b>C</b>	Email - from Command (PM/PC, DPM/DPC)	Direct
<b>D</b>	Email - from Kennel Master	Direct
<b>E</b>	Phone	Direct
<b>F</b>	WDMS Trouble Ticket	As set in WDMS
<b>NOTES:</b> (1) The <u>preferred method</u> is a scanned signed letter attached to an email. Hardcopy correspondence can be sent via 1 <sup>st</sup> Class mail. Use of traceable carrier is only required when specifically requested by the program office.		

<b>Table C-3.--Submission and Inquiry Routing Table</b>					
<b>Topic</b>	<b>Manual Reference</b>	<b>POC Table C-1</b>		<b>Media ID Table C-2</b>	<b>Notes</b>
		<b>Primary</b>	<b>CC</b>		
<b>FACILITY / EQUIPMENT</b>					
Report project for permanent kennel facility [MILCON over \$750K]	9003.3	PM		A	(8)
Request funding assistance for kennel facility project [under \$750K]	9108.6	PM		A	(8)
Request funding assistance for equipment	9205	PM		A	
Request assistance with MWD trailer maintenance	9206.3b	DPM		D	
Report CETASM project	12102.11b	DPM		D	
<b>NON-OPERATIONAL MISSION</b>					
Report delays to support non-operational mission	Table 6-4	OM	DPM	D	(6)
Report incident during support to civilian LE	6303.7	PM	DPM	D	
Submit mission after-action report	6304.12b(3)	OM	DPM	D	
<b>PERFORMANCE</b>					
Report New Dog discrepancies (45 days)	5302.2a(1)	OM	PC	D	
Report New Dog w/o team validation (75 days)	5302.2a(3)	OM	PC	D	
Request training assistance for experienced MWD with discrepancies	5302.2b	OM	PC	D	
Report newly assigned MWD not considered operational	8202.3b	OM	DPM	D	
Request for assistance to improve section operating status	8307.1b(6)	DPM		C	
<b>RESOURCES</b>					
Submit contract for review/approval for contract working dog (CWD) team support	Table 3-1	PM		A	

<b>Table C-3.--Submission and Inquiry Routing Table</b>					
<b>Topic</b>	<b>Manual Reference</b>	<b>POC Table C-1</b>		<b>Media ID Table C-2</b>	<b>Notes</b>
		<b>Primary</b>	<b>CC</b>		
Report MOS qualified KM not available	3307.3	OM	DPM	D	
Request MWD structure change in T/E	7104.2	PM		A	(10)
Request replacement order	7204	OM	DPM	D	(1)
Submit MWD disposition request package	7304.1	OM		See (9)	(2) (9)
Request to change MWD capability/NSN	7402.1	OM	DPM	A	(5)
Report missing records for new MWD	8202.2c	OM	PC	D	
Request travel documentation for MWD transfer	8203.1b	OM	DPM	D	
Report unexpected MWD Loss	8204.1	OM	DPM	D	
Request for special use of deceased MWD	8204.2	PM		A	
Submit final disposition documents	Table 8-5 Table 8-7	OM		B	(3) (4)
Report delay in submitting final documentation	Table 8-5 Table 8-7	OM		D	
<b>TRAINING</b>					
Request approval for formal DoD handler training	3103 App P (P-3)	PC	DPM	D	
Request approval for non-standard training techniques	3105.2	PM	DPM	D	
Report requirement for E-collar training	3105.1	PC	DPM	D	
Request approval for additional training	5203.2c	DPM	PC	D	
Request training assistance	5203.4g 5302.1	DPM	PC	D	
<b>TRAINING AIDS</b>					
Inquiry concerning drug training aid policy conflict w/AFMES	11004	DPM		D	

<b>Table C-3.--Submission and Inquiry Routing Table</b>					
<b>Topic</b>	<b>Manual Reference</b>	<b>POC Table C-1</b>		<b>Media ID Table C-2</b>	<b>Notes</b>
		<b>Primary</b>	<b>CC</b>		
Report issues with drug training aid quality/availability	11005	DPM	PC	D	
Request approval to utilize pseudo-drug training aids	11011	DPM	OM PC	A	
Request approval to utilize non-standard drug DEA codes	11102	DPM		D	
Request change to drug scent kit	11103	DPM	OM PC	A	
Inquiry concerning explosive training aid procedural guidance	12005	DPM		D	
Report issues with explosive/non-explosive training aid quality / availability	12006	DPM	OM PC	D	
Request approval for training on specialized or blended explosive substances	12007	DPM	OM PC	D	
Request approval to utilize pseudo-explosive training aids	12013	DPM	OM PC	A	
Request CEAP change	12102.2	DPM	OM PC	B	
Request CEAP component replacement	12102.7b	DPM	OM PC	D	
Request special TAMIS authorization for deployment CEAP	12402.1	DPM	OM PC	C	
<b>WDMS</b>					
Inquiry about MWD section structure change in WDMS	7103.3 7104.2	DPM	OM	B	(1)
Advance personnel recording for WDMS	8003.1	OM	DPM	F	(7)
Report personnel transfers	8003.3c	OM	DPM	F	(7)



Table C-3.--Submission and Inquiry Routing Table					
Topic	Manual Reference	POC Table C-1		Media ID Table C-2	Notes
		Primary	CC		
Request guidance on changing historical team activity records.	8104.1f(3)	DPM		D	
Request alternative documentation when WDMS down for extended period	8105.1b	DPM	PC	D	
Request WDMS access Submit [SAAR form]	App E	DPM		D	
<p>NOTES:</p> <p>(1) Expect <u>10 working days</u> for published force structure changes to be reflected in WDMS. After that, the kennel master can submit a WDMS trouble ticket [Admin] requesting status.</p> <p>(2) Expect response from program office within <u>15 working days</u> after confirmed receipt of the package. After that, kennel master can initiate a WDMS trouble ticket (Admin) with a request for status information.</p> <p>(3) Disposition documents can be scanned and submitted via email. Otherwise, send documents via 1<sup>st</sup> class mail to primary POC address.</p> <p>(4) Expect MWD to be removed in WDMS within <u>10 working days</u> after confirmed receipt of the DD Form 1834. After that, the kennel master can submit a WDMS trouble ticket [Admin] requesting status.</p> <p>(5) Expect MWD NSN to be changed in WDMS within <u>15 working days</u> of the confirmed receipt of the request package. After that, the kennel master can submit a WDMS trouble ticket [Admin] requesting status.</p> <p>(6) If POC cannot be contacted for explosive non-operational missions, inquiries can be directed to the Air Force Law and Order Division MWD Scheduling Cell [JBSA-Lackland, TX] at:  Commercial (210) 925-1660  DSN 945-1660  Cell (210) 837-8413.</p> <p>(7) WDMS trouble tickets are automatically routed to specified POCs.</p> <p>(8) Include copy of the completed DD Form 1391 for the project.</p>					

24 FEB 2020

<b>Table C-3.--Submission and Inquiry Routing Table</b>					
<b>Topic</b>	<b>Manual Reference</b>	<b>POC Table C-1</b>		<b>Media ID Table C-2</b>	<b>Notes</b>
		Primary	CC		
<p>(9) Send scanned documents via the MWD Electronic Disposition Safe Access File Exchange. Instructions are in the WDMS library.</p> <p>(10) Changes request for MWD authorization change must be submitted on a TOECR per reference (v). A command request letter should be routed separately.</p>					

**APPENDIX D**

Military Working Dog (MWD) Team Qualification Standards &  
Guidelines

**Table of Contents**

<u>IDENTIFICATION</u>	<u>TITLE</u>	<u>PAGE</u>
<b>PARAGRAPH</b>		
1	Purpose.....	D-2
2	TVC Process.....	D-2
3	Qualification Terminology.....	D-2
4	Evaluator.....	D-3
5	Blank/No-Aid Detection Event.....	D-3
6	Command Language.....	D-4
7	Medical Waiver.....	D-4
8	New Dog Validation.....	D-4
9	Extended Validation.....	D-5
10	Failed Validation Events.....	D-6
11	Failure to Meet the Performance Standards.....	D-6
<b>TABLES</b>		
D-1	Qualification Terminology.....	D-3
D-2	Evaluator's Guide for Extended Validations.....	D-5
D-3	New Dog Field Transition Training.....	D-8
D-4A	Training Guideline - Non-Validated Team.	D-10
D-4B	Training Standards - Validated Team.....	D-12
D-4C	Training Guideline - Caretaker Status...	D-13
D-5	Validation Standards.....	D-15
D-6	Certification Standards.....	D-19
<b>TABS</b>		
D1	Basic MWD Skills Evaluation Guideline...	D1-1
D2	Patrol Dog Evaluation Guideline.....	D2-1
D3	Detector Dog [Drug & Explosive] Evaluation Guideline.....	D3-1
D4	Specialized Search Dog Evaluation Guideline.....	D4-1
D5	Combat Tracker Dog Evaluation Guideline.	D5-1

**NOTE:**

"MWD Team" applies to both military and  
civilian police unless noted.

24 FEB 2020

1. Purpose. To establish the standards and guidelines by which U.S. Marine Corps Military Working Dog (MWD) Teams will be evaluated to determine their readiness to perform duties with installation security operations, Range of Military Operations (ROMO) or other Federal/state/local law enforcement agencies. These standards will be used for the purpose of qualification of teams once they are assigned to an installation or MEF kennel facility.

2. TVC Process

a. The Marine Corps has a three-phase process, called the TVC Process for Training/Validation/Certification, to evaluate the team qualification to meet mission readiness as depicted in tables D-4A, B, C [Training], table D-5 [Validation], and table D-6 [Certification].

b. Teams shall meet the prerequisites, specified in tables D-4 thru D-6 [block 4], for the entry of evaluation events in WDMS.

c. Teams should conduct pre-validation training in accordance with the guidelines of tables D-3 and 4A.

d. Teams shall remain in compliance with the post-validation standards of table D-4B.

e. Teams shall meet the performance standards, specified in tables D-5 thru D-6, for the MWD capability listed. See paragraph 8 [New Dog Validation] for additional requirements that must be completed prior to the first team validation for an MWD on first assignment.

3. Qualification Terminology. It is important for users of this appendix to be familiar with the terminology illustrated in table D-1.

Table D-1.--Qualification Terminology					
Term	Definition	Examples within Each Process			
Process	One of the primary areas of team qualification.	Basic Skills	Patrol	Detection	Tracking
Event	Complete planned session with a specific objective to test team skills.	Obstacle Course	Controlled Aggression	Building Search	Urban Track
Task	Each individual test (aid, command, obstacle) making up an event.	Tunnel	Pursuit & Attack	Placement of aid under table	Finding the Quarry
Trial	Each time the MWD is exposed to the task (aid, command, and obstacle).	Each command as the MWD is introduced to the obstacle.	Each command	Each opportunity the team has at the task location	N/A
Response	MWD action to the stimulus in each trial.	Positive: Meets requirement Negative: Does not meet requirement [see paragraph 4]			Positive: Quarry found Negative: Quarry not found

4. Evaluator. The term evaluator used throughout this appendix relates may relate to one of following two key individuals involved in the validation/certification process:

a. Validation/Certification Report Evaluator. The kennel master is responsible to sign all MWD qualification reports, assign competent event evaluators, and supervise the conduct of the events/recording process. Ideally, it would be best to have the report and event evaluator, but that is not always practical. In any case, the kennel master must assign an event evaluator who meets the requirements defined below.

b. Event Evaluator. Normally, this task is done by the trainer. but the kennel master can assign other qualified individuals either within the section or from some other Marine Corps unit. The event evaluator must be experienced in the validation process and have a good working knowledge of the specific evaluator guideline for the assigned MWD capability [see Tabs D1 thru D5].

5. Blank/No-Aid Detection Event. Conducting Blank/No-Aid events is required for all phases of the TVC process. The purpose of this type of event is to determine if the MWD is incorrectly responding just to receive a reward or due to an undesirable habit of responding to a certain type of container or object regardless of the presence of odor. In this type of evaluation, the lack of response would be positive and meet the requirement. An MWD response in this event would be recorded as a "False" response. In WDMS, a favorable completion of a blank/no-aid event would be the recording of the search time without a response indicated. Refer to the WDMS operator's manual for instructions about entering this type of event.

6. Command Language. Handlers will be allowed to use the language identified on the 341 TRS Form LAFB 375 and/or the Form DD 1834 to communicate the MWD instructional commands during the qualification events. Evaluators should refer to these documents to ensure that the handler is correctly communicating commands. If the MWD has been retrained in English commands, this change should be reflected in the remarks section of the MWD Form DD 1834 per instructions in Appendix E.

7. Medical Waiver. The obstacle course and gunfire [events of Basic Skills validation] are the only events which can be removed from the validation requirement. To qualify for an exemption from the event, a DoD veterinarian must examine the MWD and generate a signed medical waiver letter which is maintained in the MWD Medical Record with a copy in the MWD Service Record. Conditions under which an MWD would be considered for such a waiver would relate to prevention of damage to an existing MWD injury or acceleration to a deteriorating health condition. Normally, the MWD would also be assigned a lower medical category code when the waiver is generated. The medical waiver information [date signed & issuing veterinarian] is to be recorded in the WDMS comments field when recording the obstacle course/gunfire validation. The following are not justification for an event waiver:

- a. MWD age alone for the obstacle course.
- b. Lack of blank cartridges for gunfire.

8. New Dog Validation

- a. An MWD coming straight from the formal basic capability training at the 341 TRS is identified as a New Dog. The

24 FEB 2020

receiving unit shall evaluate each New Dog to determine the following:

(1) Confirmation that the MWD can perform at the qualification level documented in the MWD's Form LAFB 375 prepared by the 341 TRS.

(2) Confirmation that the MWD will suitably perform in the operational environment.

b. To accomplish the above, the receiving unit should use tables D-3 and D-4A to achieve all the required skill validations conducted in accordance with table D-5.

c. Refer to Chapter 5 (section 5300) for actions relating to not meeting validation timelines stated in paragraph 5204.4.

#### 9. Extended Validation

a. Based on the type of qualification event, an extended validation may be granted at the evaluator's discretion as described in table D-2. The extension is intended to give the evaluator flexibility in conserving time and resources where a team fault was minor and in the evaluator's opinion can be relatively easily remedied. More details concerning extended validations are included in the Evaluator Guides provided in the tabs to this appendix. The team cannot be re-evaluated on the same day an event is failed.

<b>Table D-2.--Evaluator's Guide for Extended Validation</b>		
<b>Qualification Process</b>	<b>Event</b>	<b>Extension Authorization</b>
<b>Basic Skills</b>	Obedience	One Extended Validation per event for only one task authorized
	Obstacle Course	
	Gun Fire	
<b>Patrol</b>	Controlled Aggression	One Extended Validation per event for only one task authorized
	Building Search	<ul style="list-style-type: none"> <li>• No Extended Validation Authorized</li> <li>• Test entire event again</li> </ul>
	Sight Scouting	
	Scent Scouting	
	Sound Scouting	

Table D-2.--Evaluator's Guide for Extended Validation		
Qualification Process	Event	Extension Authorization
Detection	Drug Search Area	<ul style="list-style-type: none"> <li>• <u>Validation</u>: One Extended Validation per event for only one task authorized</li> </ul>
	Explosive Search Area	<ul style="list-style-type: none"> <li>• <u>Certification</u>: No Extended Validation Authorized</li> </ul>
Tracking	Urban Track	<ul style="list-style-type: none"> <li>• No Extended Validation Authorized</li> </ul>
	Rural Track	<ul style="list-style-type: none"> <li>• Test entire event again</li> </ul>

b. Events completed with an extended validation will be recorded in WDMS on the date of successful completion, not the date when the team event started. The granting of the extended validation will be noted along with supporting comments in the data entry of the validation results.

**Note:** WDMS will only allow entry of successfully completed individual validation events.

c. If the team successfully meets the performance standard, the team can be validated. New validation events for all required tasks must be scheduled at a future date when the evaluator determines the team is prepared for success. Failed events are to be recorded as training activity in WDMS.

10. Failed Validation Events. Inability to meet validation performance standards in each of the requirement events constitutes a failure of the specific validation process [e.g., failing the Obstacle Course is a failure of the Basic Skills validation even if the other two events were passed]. Individual validation events recorded in WDMS as passing, but later classified as no longer usable toward validation, the event must be changed to a training event in WDMS. Recorded validation events in WDMS that have become "aged" [outside the event grouping required for a validation process period per Chapter 6], must be changed in WDMS to a training event.

11. Failure to Meet the Performance Standards

a. Training. The pre-validation training guidance, as stated in tables D-4A and 4C, are guidelines for the KM in planning the team optimum training plan and unit training plan. The post-validation performance standards of table D-4B shall be incorporated into the unit training plan to ensure compliance



with stated validation revoke criteria. It is the KM's responsibility to conduct an effective training program within the limitations of the unit operational commitments. Failure to meet the published standards may have negative impact on team effectiveness unless the team is actively employed in MWD related utilization. Limited training activity may impact the requirements for validation [e.g., MWD not exposed to odors] which in turn impacts team readiness and MWD section operating status.

b. Validation. Validation performance standards, as stated in table D-5, are requirements established by Headquarters, Marine Corps, to ensure MWD teams are uniformly evaluated to determine their preparedness to meet operational commitments. Failure to meet the performance standards directly impacts the team and unit readiness. Teams not meeting the performance standards are subject to reassignment or in the case of unsatisfactory MWD performance, disposal. Refer to Chapter 5 (section 5300) for additional guidance.

c. Certification. Certification performance standards, as stated in table D-6, are guidelines for use by the installation search granting authority/designee in the conduct of witnessing a team's capability to effectively support probable cause searches. Since the team must hold a current detection validation prior to certification; it is not likely that a team will fail to satisfactory complete the certification process.

<b>Table D-3.--New Dog Field Transition Training</b> NOTE: Complete MWD FEQ at earliest date; 75 day or Team validation. U.S. MARINE CORPS MWD Program			
1. Phase	2. Evaluator	3. Evaluation Frequency	4. Prerequisite
N/A	Handler / Trainer	N/A	Entry any time after team assigned date in WDMS
MWD Capability (Type)		<b>Basic Skills - ALL</b>	
<b>5. Performance Standard:</b> <ul style="list-style-type: none"> <li>• Complete following transition actions per reference (ao):               <ul style="list-style-type: none"> <li>- Social rapport</li> <li>- Establish reward systems</li> <li>- Establish OUT/control on primary reward</li> <li>- Re-establish understanding of basic CST cues</li> <li>- Gunfire</li> <li>- Introduce progressively more difficult obedience exercises</li> <li>- Introduce detection searches of operational length and difficulty</li> </ul> </li> </ul>			
MWD Capability (Type)		<b>Drug (DDD)</b>	
<b>6. Performance Standard:</b> <ul style="list-style-type: none"> <li>• Complete following transition actions per reference (ao):               <ul style="list-style-type: none"> <li>- Re-establish final response in detection</li> <li>- Gradually reduce find frequency</li> <li>- Discourage any resulting false responses</li> </ul> </li> <li>• Imprint MWD on objective odors "USMC Required" in table B3-2 [see Appendix G5 for imprinting techniques].</li> </ul>			
MWD Capability (Type)		<b>Explosive (EDD)</b>	
<b>7. Performance Standard:</b> <ul style="list-style-type: none"> <li>• Complete following transition actions per reference (ao):               <ul style="list-style-type: none"> <li>- Re-establish final response in detection</li> <li>- Gradually reduce find frequency</li> <li>- Discourage any resulting false responses</li> </ul> </li> <li>• Imprint MWD on additional objective explosive odors "USMC Required" in table B3-2 [see Appendix G5 for imprinting techniques].</li> <li>• Introduce buried aid tasks since MWD is not trained at 341 TRS.</li> </ul>			
MWD Capability (Type)		<b>Patrol (P)</b>	
<b>8. Performance Standard:</b> <ul style="list-style-type: none"> <li>• Complete following transition actions per reference (ao):               <ul style="list-style-type: none"> <li>- Establish civil aggression</li> <li>- Establish strong full bite and high prey drive</li> <li>- Establish the OUT in bite work</li> <li>- Establish basic bite work control skills</li> <li>- Re-establish advanced, off-leash skills in controlled aggression</li> <li>- Establish building search</li> <li>- Establish area search</li> </ul> </li> <li>• Introduce MWD to decoy using bite suit and bite variation.</li> </ul>			

24 FEB 2020

<b>Table D-3.--New Dog Field Transition Training</b>			
<b>NOTE: Complete MWD FEQ at earliest date; 75 day or Team validation.</b>			
<b>U.S. MARINE CORPS MWD Program</b>			
<b>1. Phase</b>	<b>2. Evaluator</b>	<b>3. Evaluation Frequency</b>	<b>4. Prerequisite</b>
<b>N/A</b>	<b>Handler / Trainer</b>	<b>N/A</b>	<b>Entry any time after team assigned date in WDMS</b>
<b>MWD Capability (Type)</b>	<b>Specialized Search (SSD)</b>		
<b>9. Performance Standard:</b>			
<ul style="list-style-type: none"> <li>• Complete EDD transition actions along with those unique actions specified in the SSD appendix in reference (ao).</li> <li>• Imprint explosive odors same as EDD.</li> <li>• Introduce buried aid tasks since MWD was only trained at 341 TRS.</li> </ul>			
<b>MWD Capability (Type)</b>	<b>Tracking (CTD)</b>		
<b>10. Performance Standard:</b>			
<ul style="list-style-type: none"> <li>• Complete following transition actions per the CTD appendix in reference (ao).</li> <li>• Conduct advanced training so MWD is qualified to perform following: <ul style="list-style-type: none"> <li>- Down from Left Side</li> <li>- Sit from Down</li> </ul> </li> <li>• Conduct advanced training so MWD can successfully complete tracks under the following situations not qualified by the 341 TRS: <ul style="list-style-type: none"> <li>- Cross tracks</li> <li>- Night event</li> </ul> </li> </ul>			

**Table D-4A.--Training Guideline – Non-Validated Team**

**NOTE: The KM should maintain the training specified in this table to meet the team validation timeline in figure 5-2.**  
**U.S. MARINE CORPS MWD Program**

1. Phase	2. Evaluator	3. Evaluation Frequency	4. Prerequisite
1	Handler / Trainer	Monthly	Entry any time after team assigned date in WDMS

MWD Capability (Type)

**Basic Skills - ALL**

**5. Performance Standard:**

- Complete transition training, as needed, from table D-3.
- Conduct a minimum of three, twenty-minute periods of running/walking weekly per conditioning guidance in paragraph 10006.
- Conduct a minimum of twenty hours of Basic MWD Skills training monthly.
- Conduct at least one monthly gunfire training event with twenty rounds (minimum) that meet requirements of table D1-2.
- Conduct basic skills training per guidance in tab G6.

MWD Capability (Type)

**Drug (DDD)**

**6. Performance Standard:**

- Complete transition training, as needed, from table D-3.
- Conduct a minimum of twelve hours of drug detection training monthly.
- Conduct monthly detection training events that will include a minimum of eight tasks for each available odor.
- Conduct a minimum of two blank/no-aid detection events monthly (minimum twenty minutes).
- The handler may or may not know the aid location.
- Conduct detection training per guidance in Appendix G (Techniques).

MWD Capability (Type)

**Explosive (EDD)**

**7. Performance Standard:**

- Complete transition training, as needed, from table D-3.
- Conduct a minimum of twelve hours of explosive detection training monthly.
- Conduct monthly detection training events that will include a minimum of eight tasks for each available odor.
- Conduct at least a total of six buried aid detection tasks during the month.
- Conduct a minimum of two blank/no-aid detection event monthly (minimum twenty minutes).
- The handler may or may not know the aid location.
- Conduct detection training per guidance in Appendix G

<b>Table D-4A.--Training Guideline – Non-Validated Team</b>			
<p><b>NOTE:</b> The KM should maintain the training specified in this table to meet the team validation timeline in figure 5-2.</p> <p align="center"><b>U.S. MARINE CORPS MWD Program</b></p>			
<b>1. Phase</b>	<b>2. Evaluator</b>	<b>3. Evaluation Frequency</b>	<b>4. Prerequisite</b>
<b>1</b>	<b>Handler / Trainer</b>	<b>Monthly</b>	<b>Entry any time after team assigned date in WDMS</b>
(Techniques).			
<b>MWD Capability (Type)</b>		<b>Patrol (P)</b>	
<p><b>8. Performance Standard:</b></p> <ul style="list-style-type: none"> <li>• Complete transition training, as needed, from table D-3.</li> <li>• Conduct a minimum of twelve hours of patrol training monthly.</li> <li>• Conduct training on each patrol task for a minimum of four times monthly.</li> <li>• Conduct patrol training per guidance in tab G7.</li> </ul>			
<b>MWD Capability (Type)</b>		<b>Specialized Search (SSD)</b>	
<p><b>9. Performance Standard:</b></p> <ul style="list-style-type: none"> <li>• Complete transition training, as needed, from table D-3.</li> <li>• Same as EDD except off-leash <u>and</u> a total of 16 buried aid tasks during month.</li> <li>• Same as EDD except off-leash.</li> <li>• Conduct detection training per guidance in reference (ao).</li> </ul>			
<b>MWD Capability (Type)</b>		<b>Tracking (CTD)</b>	
<p><b>10. Performance Standard:</b></p> <ul style="list-style-type: none"> <li>• Complete transition training, as needed, from of table D-3.</li> <li>• Conduct a minimum of sixteen tracking events monthly.</li> <li>• At a minimum at least four tracks will be 1600m (one mile) in length.</li> <li>• The handler may or may not know the quarry location.</li> <li>• Conduct tracking training per guidance in reference (ao).</li> </ul>			

<b>Table D-4B.--Training Standards – Validated Team</b>			
<b>NOTE: The KM will use the training activities specified in this table as the minimum criteria for maintaining an MWD team validation.</b>			
<b>U.S. MARINE CORPS MWD Program</b>			
<b>1. Phase</b>	<b>2. Evaluator</b>	<b>3. Evaluation Frequency</b>	<b>4. Prerequisite</b>
<b>1</b>	<b>Handler / Trainer</b>	<b>Monthly</b>	<b>Entry any time after team assigned date in WDMS</b>
<b>MWD Capability (Type)</b>		<b>Basic Skills - ALL</b>	
<b>5. Performance Standard:</b>			
<ul style="list-style-type: none"> <li>• Conduct a minimum of three, <u>twenty-minute</u> periods of running/walking <u>weekly</u> per conditioning guidance in paragraph 10006.</li> <li>• MWD satisfactorily conducts each of the seven obedience on-leash tasks at least once each month.</li> <li>• MWD satisfactorily conducts at least one obstacle course event each month.</li> <li>• MWD conducts at least twenty rounds of gunfire training during the prior three calendar months.</li> </ul>			
<b>MWD Capability (Type)</b>		<b>Drug (DDD)</b>	
<b>6. Performance Standard:</b>			
<ul style="list-style-type: none"> <li>• MWD satisfactorily detects each available drug odor at least once each month. [If a required odor is not available, complete a non-availability letter per paragraph 8105.4.]</li> </ul>			
<b>MWD Capability (Type)</b>		<b>Explosive (EDD)</b>	
<b>7. Performance Standard:</b>			
<ul style="list-style-type: none"> <li>• MWD satisfactorily detects each available explosive odor at least once each month. [If a required odor is not available, complete a non-availability letter per paragraph 8105.4.]</li> </ul>			
<b>MWD Capability (Type)</b>		<b>Patrol (P)</b>	
<b>8. Performance Standard:</b>			
<ul style="list-style-type: none"> <li>• MWD satisfactorily conducts training in each of the three patrol events [controlled aggression (five tasks), building search and scout (one scent)] during each month.</li> </ul>			
<b>MWD Capability (Type)</b>		<b>Specialized Search (SSD)</b>	
<b>9. Performance Standard:</b>			
<ul style="list-style-type: none"> <li>• Same as EDD except off-leash.</li> </ul>			
<b>MWD Capability (Type)</b>		<b>Tracking (CTD)</b>	
<b>10. Performance Standard:</b>			
<ul style="list-style-type: none"> <li>• MWD completes at least one tracking event with a successful find during each month.</li> </ul>			

<b>Table D-4C.--Training Guideline – Caretaker Status</b>			
<b>[See paragraph 7307 for MWD in Disposition Status]</b>			
<b>U.S. MARINE CORPS MWD Program</b>			
1. Phase	2. Evaluator	3. Evaluation Frequency	4. Prerequisite
1	Handler / Trainer	Monthly	Entry any time after team assigned date in WDMS
<b>MWD Capability (Type)</b>		<b>Basic Skills - ALL</b>	
<b>5. Performance Standard:</b>			
<ul style="list-style-type: none"> <li>• Conduct a minimum of three, <u>twenty-minute</u> periods of running/walking <u>weekly</u> per conditioning guidance in paragraph 10006.</li> <li>• Conduct a minimum of one hour of Basic MWD Skills training weekly.</li> <li>• Conduct quarterly gunfire training with twenty rounds (minimum) that meet requirements of table D1-2.</li> <li>• Conduct basic skills training per guidance in tab G6.</li> </ul>			
<b>MWD Capability (Type)</b>		<b>Drug (DDD)</b>	
<b>6. Performance Standard:</b>			
<ul style="list-style-type: none"> <li>• Conduct a minimum of one hour of drug detection training monthly.</li> <li>• Conduct monthly detection training events that will include a minimum of one task for each available odor.</li> <li>• The handler may or may not know the aid location.</li> <li>• Conduct detection training per guidance in Appendix G (Techniques).</li> </ul>			
<b>MWD Capability (Type)</b>		<b>Explosive (EDD)</b>	
<b>7. Performance Standard:</b>			
<ul style="list-style-type: none"> <li>• Conduct a minimum of one hour of explosive detection training monthly.</li> <li>• Conduct monthly detection training events that will include a minimum of one task for each available odor.</li> <li>• Conduct at least a total of one buried aid detection task during the month.</li> <li>• The handler may or may not know the aid location.</li> <li>• Conduct detection training per guidance in Appendix G (Techniques).</li> </ul>			
<b>MWD Capability (Type)</b>		<b>Patrol (P)</b>	
<b>8. Performance Standard:</b>			
<ul style="list-style-type: none"> <li>• Conduct training on each patrol task for a minimum of once monthly.</li> <li>• Conduct patrol training per guidance in tab G7.</li> </ul>			

<b>Table D-4C.--Training Guideline – Caretaker Status</b>			
<b>[See paragraph 7307 for MWD in Disposition Status]</b>			
<b>U.S. MARINE CORPS MWD Program</b>			
<b>1. Phase</b>	<b>2. Evaluator</b>	<b>3. Evaluation Frequency</b>	<b>4. Prerequisite</b>
<b>1</b>	<b>Handler / Trainer</b>	<b>Monthly</b>	<b>Entry any time after team assigned date in WDMS</b>
<b>MWD Capability (Type)</b>		<b>Specialized Search (SSD)</b>	
<b>9. Performance Standard:</b>			
<ul style="list-style-type: none"> <li>• Same as EDD except off-leash <u>and</u> a total of two buried aid tasks during month.</li> <li>• Conduct detection training per guidance in reference (ao).</li> </ul>			
<b>MWD Capability (Type)</b>		<b>Tracking (CTD)</b>	
<b>10. Performance Standard:</b>			
<ul style="list-style-type: none"> <li>• Conduct a minimum of two tracking events monthly.</li> <li>• At a minimum at least one track will be 1600m (one mile) in length.</li> <li>• The handler may or may not know the quarry location.</li> <li>• Conduct track training per guidance in reference (ao).</li> </ul>			



<b>Table D-5.--Validation Standards</b>			
<b>U.S. MARINE CORPS MWD Program</b>			
1. Phase	2. Evaluator	3. Evaluation Frequency	4. Prerequisite
2	Kennel Master	180 Calendar Days	<ul style="list-style-type: none"> <li>• Current Validation in WDMS <u>Or</u></li> <li>• Training event recorded in WDMS in past 15 calendar days <u>Or</u></li> <li>• Validation event recorded in WDMS in past 12 calendar days</li> </ul>
MWD Capability (Type)		<b>Basic Skills - ALL</b>	
<b>5. Performance Standard:</b>			
<ul style="list-style-type: none"> <li>• No failures on the Basic MWD Skills validation conducted over a maximum of three events.</li> <li>• Refer to Tab D1 for evaluation guidelines.</li> </ul>			
MWD Capability (Type)		<b>Drug (DDD)</b>	
<b>6. Performance Standard:</b>			
<ul style="list-style-type: none"> <li>• Perform a minimum of two tasks per available odor over a maximum of five events. Residual odor cannot be used during a validation.</li> <li>• The handler will not know the aid location.</li> <li>• Testing accuracy [total positive responses/total trials] will be a minimum of 90%.</li> <li>• Respective odor will be divided into at least three different search areas, one of which will be a blank/no-aid event. Validation blank duration is twenty minutes.</li> <li>• No more than one false response during the validation process.</li> <li>• No more than three fringe responses during the validation process.</li> <li>• At least one event will be twenty minutes in duration.</li> <li>• Handler should have:               <ul style="list-style-type: none"> <li>o [MEF] PPE and T/O weapon and/or "red gun"</li> <li>o [Installation] "Black gear" and T/O weapon</li> </ul> </li> <li>• Refer to Tab D3 for evaluation guidelines.</li> </ul>			
MWD Capability (Type)		<b>Explosive (EDD)</b>	
<b>7. Performance Standard:</b>			
<ul style="list-style-type: none"> <li>• Perform a minimum of two tasks per available odor over a maximum of five events. Residual odor cannot be used during a validation.</li> <li>• The handler will not know the aid location.</li> <li>• Testing accuracy [total positive responses/total trials] will be a minimum of 95%.</li> </ul>			

<b>Table D-5.--Validation Standards</b>			
<b>U.S. MARINE CORPS MWD Program</b>			
1. Phase	2. Evaluator	3. Evaluation Frequency	4. Prerequisite
2	Kennel Master	180 Calendar Days	<ul style="list-style-type: none"> <li>• Current Validation in WDMS <u>Or</u></li> <li>• Training event recorded in WDMS in past 15 calendar days <u>Or</u></li> <li>• Validation event recorded in WDMS in past 12 calendar days</li> </ul>
<ul style="list-style-type: none"> <li>• Respective odor will be divided into at least three different search areas, one of which will be a blank/no-aid event and one will be a night event with NVD. Refer to definition in Tab D3 Section I for night event description and NVD options. Validation blank duration is twenty minutes.</li> <li>• At least one event will be twenty minutes in duration.</li> <li>• At least one task will include a buried explosive aid. Buried aid must be placed at a <u>depth not to exceed</u> three inches with a thirty-minute sit time.</li> <li>• No more than one false response during the validation process.</li> <li>• No more than three fringe responses during the validation process.</li> <li>• Handler should have:               <ul style="list-style-type: none"> <li>o [MEF] PPE and T/O weapon and/or "red gun"</li> <li>o [Installation] "Black gear" and T/O weapon</li> </ul> </li> <li>• Refer to Tab D3 for evaluation guidelines.</li> </ul>			
MWD Capability (Type)		<b>Patrol (P)</b>	
<b>8. Performance Standard:</b> <ul style="list-style-type: none"> <li>• No failures on the Patrol Skills validation conducted over a maximum of five events.</li> <li>• Handler should have:               <ul style="list-style-type: none"> <li>o [MEF] PPE and T/O weapon and/or "red gun"</li> <li>o [Installation] Black gear and T/O weapon</li> </ul> </li> <li>• Refer to Tab D2 for evaluation guidelines.</li> </ul>			

24 FEB 2020

<b>Table D-5.--Validation Standards</b>			
<b>U.S. MARINE CORPS MWD Program</b>			
1. Phase	2. Evaluator	3. Evaluation Frequency	4. Prerequisite
2	Kennel Master	180 Calendar Days	<ul style="list-style-type: none"> <li>• Current Validation in WDMS <u>Or</u></li> <li>• Training event recorded in WDMS in past 15 calendar days <u>Or</u></li> <li>• Validation event recorded in WDMS in past 12 calendar days</li> </ul>
MWD Capability (Type)		<b>Specialized Search (SSD)</b>	
<b>9. Performance Standard:</b>			
<ul style="list-style-type: none"> <li>• Perform a minimum of two tasks per available odor over a maximum of five events.</li> <li>• Testing accuracy [total positive responses/total trials] will be a minimum of 95%.</li> <li>• Respective odor will be divided into at least one each of the four different search areas, one will be a blank/no-aid event and one will be a night event with NVD. Refer to definition in Tab D4 Section I for night event description and NVD options. Validation blank duration is twenty minutes.</li> <li>• At least one event will be twenty minutes in duration.</li> <li>• At least one task will include a buried explosive aid. Buried aid must be placed at a <u>depth not to exceed</u> three inches with a thirty-minute sit time.</li> <li>• No more than two false responses during the validation process.</li> <li>• No more than three fringe responses during the validation process.</li> <li>• Handler should have PPE and T/O weapon and/or "red gun".</li> <li>• Refer to Tab D4 for evaluation guidelines.</li> </ul>			
MWD Capability (Type)		<b>Tracking (CTD)</b>	
<b>10. Performance Standard:</b>			
<ul style="list-style-type: none"> <li>• Conduct at least two tracks (max four events) in which the quarry is successfully located, one to be at low light, to include at least one each of the following area tracks: <ul style="list-style-type: none"> <li><b><u>Rural Area</u></b></li> <li>- In the range of 1000 - 1600 meters (1 mile max)</li> <li>- One hidden quarry</li> <li>- The quarry will jog a portion of the track</li> <li>- At least four deliberate movements, at least one turn and one angle</li> <li>- Minimum two obstacles</li> <li>- At least one known cross track</li> </ul> </li> </ul>			

<b>Table D-5.--Validation Standards</b>			
<b>U.S. MARINE CORPS MWD Program</b>			
1. Phase	2. Evaluator	3. Evaluation Frequency	4. Prerequisite
2	Kennel Master	180 Calendar Days	<ul style="list-style-type: none"> <li>• Current Validation in WDMS <u>Or</u></li> <li>• Training event recorded in WDMS in past 15 calendar days <u>Or</u></li> <li>• Validation event recorded in WDMS in past 12 calendar days</li> </ul>
<ul style="list-style-type: none"> <li>- Gunfire during event from which MWD must recover and continue to work:               <ul style="list-style-type: none"> <li>o Evaluator fires two rounds from 26 to 100 meters away <u>and</u></li> <li>o Handler fires two rounds</li> </ul> </li> <li>- One hour aged track</li> <li>- Complete track in one hour</li> <li>- Handler will have a known direction of travel</li> <li><b><u>Urban/Commercial Area</u></b> <ul style="list-style-type: none"> <li>- In range of 300 to 400 meters (1/4 mile max)</li> <li>- One hidden quarry</li> <li>- Quarry will jog a portion of the track</li> <li>- At least two deliberate movements</li> <li>- At least two separate surfaces will be crossed</li> <li>- At least one known cross track</li> <li>- At least one obstacle</li> <li>- Thirty-minute aged track</li> <li>- Complete track in one half hour</li> <li>- Handler will have a known direction of travel</li> </ul> </li> <li>- Gunfire during event from which MWD must recover and continue to work:               <ul style="list-style-type: none"> <li>o Evaluator fires two rounds from 26-100 meters away <u>and</u></li> <li>o Handler fires two rounds</li> </ul> </li> <li>• Handler should have PPE and T/O weapon and/or "red gun"</li> <li>• Refer to Tab D5 for evaluation guidelines.</li> </ul>			

24 FEB 2020

<b>Table D-6.--Certification Standards</b>			
<b>U.S. MARINE CORPS MWD Program</b>			
<b>1. Phase</b>	<b>2. Evaluator</b>	<b>3. Eval. Frequency</b>	<b>4. Prerequisite</b>
3	Search Granting Authority	365 Calendar Days	Current validation on file.
<b>MWD Capability (Type)</b>		<b>Drug (DDD)</b>	
<b>5. Performance Standard:</b>			
<ul style="list-style-type: none"> <li>• Certification is meant to be an odor recognition evaluation in which the MWD must successfully complete all tasks by detecting odors as trained. <i>This activity is not intended to be a scenario-based event.</i></li> <li>• Perform a minimum of one task per available odor, normally conducted during one event but can involve up to four events. Residual odor cannot be used during a certification.</li> <li>• Testing accuracy [total positive responses/total trials] will be 100% on each available odor.</li> <li>• Conduct on-leash or off-leash.</li> <li>• The handler will not know the aid location.</li> <li>• No more than one false response during the event.</li> <li>• No more than one fringe response during the event.</li> <li>• Certification event will be witnessed by the search granting authority / designee.</li> <li>• Refer to Tab D3 for evaluation guidelines.</li> </ul>			
<b>MWD Capability (Type)</b>		<b>Explosive (EDD)</b>	
<b>6. Performance Standard:</b>			
<ul style="list-style-type: none"> <li>• Certification is meant to be an odor recognition evaluation in which the MWD must successfully complete all tasks by detecting odors as trained. <i>This activity is not intended to be a scenario-based event.</i></li> <li>• Perform a minimum of one task per available odor over a maximum of four events. Residual odor cannot be used during a certification.</li> <li>• Testing accuracy [total positive responses/total trials] will be 100% on each available odor.</li> <li>• Conduct on or off-leash.</li> <li>• The handler will not know the aid location.</li> <li>• No more than one false response during the event.</li> <li>• No more than one fringe response during the event.</li> <li>• Handler will be in the uniform of the day.</li> <li>• Certification event will be witnessed by the search granting authority / designee.</li> <li>• Refer to Tab D3 for evaluation guidelines.</li> </ul>			
<b>MWD Capability (Type)</b>		<b>Specialized Search (SSD)</b>	
<b>7. Performance Standard:</b>			
<ul style="list-style-type: none"> <li>• Same as EDD</li> </ul>			

**TAB D1**

Basic Military Working Dog (MWD) Skills Evaluation Guideline

**Table of Contents**

<u>IDENTIFICATION</u>	<u>TITLE</u>	<u>PAGE</u>
<b>SECTION</b>		
I	General Evaluator Instructions.....	D1-1
II	Basic Obedience.....	D1-2
III	Obstacle Course.....	D1-5
IV	Gunfire.....	D1-5
<b>TABLES</b>		
D1-1	Basic Skills Obedience Task Requirement by MWD Type.....	D1-2
D1-2	MWD Gunfire Validation Event Requirements.....	D1-6

The content of this tab is intended to support the completion of the MWD Basic Skills Validation Report [see NAVMC 11818-19].

**SECTION I - GENERAL EVALUATOR INSTRUCTIONS**

1. The evaluator at all times has discretion to determine the schedule and locations for events that meet the standards of table D-5 (Validation).
2. The MWD will wear at a minimum a collar. **E-collar, dummy collar or pinch collar will not be used during validation events.**
3. The time that the evaluator arrives in the evaluating area, the MWD is considered to be under evaluation, and the handler shall not reward the MWDs with balls, kongs, tugs, or similar toys until the evaluation is complete or otherwise instructed.
4. During a validation, emphasis will be placed on the MWD attitude towards work and motivation to perform tasks from the handler. Obvious fear of the handler or gross inattentiveness may be cause for failure of the evaluation at the discretion of the evaluator.

24 FEB 2020

5. The evaluator may exert as much or as little control over the progress of the exercises as he/she deems necessary, including telling the handler when to begin tasks and when they are finished.

6. The team will have one chance to perform each task as described below. Refer to table D-2 for policy on granting an extended validation.

## SECTION II - BASIC OBEDIENCE

1. These obedience tasks will be performed per the MWD type as defined in table D1-1:

Table D1-1.--Basic Skills Obedience Task Requirement by MWD Type				
Task (1)	MWD Type			
	CTD (2)	PDDD	PEDD	SSD (3)
Heel	On-Leash	On-Leash	On-Leash	Off-Leash
Down from Heel	On-Leash	On-Leash	On-Leash	Off-Leash
Down from End of Leash	On-Leash	On-Leash	On-Leash	Off-Leash also 75 meters
Sit from Down	On-Leash	On-Leash	On-Leash	Off-Leash
Sit at End of Leash	On-Leash	On-Leash	On-Leash	Off-Leash also 75 meters
Stay	On-Leash	On-Leash	On-Leash	Off-Leash also 75 meters
Recall to Heel	On-Leash	On-Leash	On-Leash	Off-Leash also 75 meters
<b>Notes:</b>				
(1) See paragraph 7 for description of tasks.				
(2) CTD perform some tasks differently as noted in paragraph 7.				
(3) SSD will perform all tasks at the equivalent "on-leash" distance of six feet <u>and</u> some tasks at an extended distance as noted in the above chart.				

2. "On-Leash" task will be performed with a six-foot leash unless otherwise noted in the above chart. For tasks away from the handler, the distance from the MWD will be at the end of the leash. In principle, all exercises are to be performed with a loose leash so that no leash tension, pressure, or corrections are required for performance of the skills. Instances of leash tension, or pressure, or corrections will be considered faults, and excessive reliance upon the leash (determined at the evaluator's discretion) may result in failure.

3. The handler may use voice commands, hand/arm commands, or combination of the two. Ideally the MWD will respond immediately to the commands, and only one command ("SIT!" or "SIT! STAY!") will be required to execute the commands correctly with no more than one correction per five commands. Additional commands will be considered faults, and excessive extra commands (determined by the evaluator's discretion) may result in failure.

4. MWD must perform a task as described in paragraph 7 and at all distances to be recorded as satisfactory in WDMS.

5. The evaluation will be run with distractions which will be determined by the evaluator; examples are: people, noise, other dogs, vehicles/horns.

6. Multiple team evaluations can be accomplished at the same time in a group formation; e.g., line formation with the evaluator facing the teams or circle formation with evaluator in the center.

7. Basic Obedience Tasks. **[All tasks will be performed as described by every MWD type unless variation is noted.]**

a. Heel. The MWD must remain in the heel position (shoulder roughly even with handler's knee, neither making excessive contact with the handler's leg nor running wider than approximately one foot from the handler's leg) while the handler performs facing and walking movements (consisting of two right turns, two left turns, two about turns, and two halts, in any order and at the evaluator's discretion). The handler may give the "HEEL!" command at the beginning of the exercise when beginning to walk, and whenever changing direction.

[CTD] MWD returns to within two feet of the handler's left side and normally in a standing position [CTD do not perform the traditional heel position].

b. Down from Heel. The MWD shall assume the down position upon command while maintaining correct position at heel. Radical shifts of position (e.g., moving directly in front of, or behind, or away from the handler) may result in failure.

[CTD] MWD assumes the down position from the heel position as defined above for CTD.

c. Down at End of Leash. The MWD shall assume the down position from the sit position at the end of the leash.



24 FEB 2020

[SSD] MWD assumes the down position from any previously commanded position or when in motion while located at 30 meters from the handler.

d. Sit from Down. The MWD shall assume the sit position from down upon command, while maintaining heel position. Radical shifts of position (e.g., moving directly in front of, or behind, or away from the handler) may result in failure.

e. Sit at End of Leash. The MWD shall assume the sit position from the down position at the end of the leash.

[SSD] MWD assumes the sit position from any previously commanded position or when in motion while located at 30 meters from the handler.

f. Stay. If the "STAY" command is used MWD will at least maintain the "STAY" command a minimum of five seconds after given the "STAY" command from each task until otherwise commanded.

[SSD] MWD performs above task while located at 30 meters from the handler.

g. Recall to Heel. MWD will return to the heel position upon command from the end of the leash. In principle the handler should not be obliged to move his/her feet or body in order to cause the MWD to place itself at heel position. Inability to return to heel position without such handler "help" may result in failure. Similarly, inability to return to heel position without leash pressure or several additional commands may also result in failure.

[SSD] MWD performs above task while located at 30 meters from the handler.

[CTD] MWD returns to the handler at the heel position as defined above for CTD.

### SECTION III - OBSTACLE COURSE

1. The Obstacle Course is to be performed with the MWD maneuvering under control of the handler between eight obstacles that are constructed of optional materials to meet the basic dimensions requirements shown below.
2. The sequence of obstacles will be selected at random at the evaluator's discretion.
3. The handler will conduct the obstacle course at a fast walking pace, with drop leash [SSD has no leash], by command of the handler.
4. If off-leash, the MWD will maintain the heel position [as defined for MWD type in section II.7] while the handler walks the MWD through the course.
5. The handler will conduct random stops between obstacles, and ensure the MWD completes the entire course.
6. An obstacle attempt is failed if the MWD fails to properly negotiate the obstacle with no more than one correction per obstacle.
7. Medical Waiver - see para. 7 (page D-4) for information as it applies to this event.
8. Course obstacles - see Appendix L [Tab 1] for the specifications for the required MWD qualification obstacle course consisting of seven types of obstacles.

### SECTION IV - GUNFIRE

1. MWD will be on **six-foot leash** [SSD is off-leash] and not muzzled for this evaluation.
2. Blank, live rounds or gunfire simulators can be used for this evaluation.
3. Arms, ammunition, and explosive safety rules will be followed.
4. The MWD can maintain a heel/stand, sit, or down position with positive handler control during the gunfire.

24 FEB 2020

5. The MWD showing aggressive behavior (to either the handler or other participants), gun-shyness, and fearfulness or becoming uncontrollable during gunfire will be cause for failure of the task.

**NOTE:** MWD moving about handler and/or barking is not considered shyness and not cause for failure.

6. All tasks listed in table D1-2 must be passed to validate for gunfire.

7. Medical Waiver - see para. 7 (page D-4) for information as it applies to this event.

<b>Table D1-2.--MWD Gunfire Validation Event Requirements</b>			
<b>Task Sequence</b>	<b>Source of Fire</b>	<b>Distance to the MWD</b>	<b>Number of Rounds</b>
1	Disinterested Party	50 feet	<b>4</b>
2	" "	10 feet	<b>4</b>
3	" "	Within 6 feet	<b>2</b>
4	Handler	Positioned next to handler	<b>10</b>
Total Rounds			<b>20</b>

**TAB D2**

Patrol Dog Evaluation Guideline

**Table of Contents**

<u>IDENTIFICATION</u>	<u>TITLE</u>	<u>PAGE</u>
<b>SECTION</b>		
I	General Evaluator Instructions.....	D2-1
II	Controlled Aggression.....	D2-2
III	Intruder Detection.....	D2-6

The content of this tab is intended to support the completion of the Patrol Validation Report [see NAVMC 11818-20].

**SECTION I - GENERAL EVALUATOR INSTRUCTIONS**

1. The evaluator at all times has discretion to determine the schedule and locations for events that meet the standards of table D-5 (Validation).
2. The MWD will wear at a minimum a collar. In the event that a pinch collar or electric correction collar has been approved for use with a particular MWD by the USMC MWD Program Manager, the MWD may wear such a device during the event.
3. The time that the evaluator arrives in the evaluating area, the MWD are considered to be under evaluation, and the handlers shall not reward the MWDs with balls, kongs, tugs, or similar toys until the evaluation is complete or otherwise instructed.
4. During a validation, emphasis will be placed on the MWD attitude towards work and motivation to perform tasks from the handler. Obvious fear of the handler or gross inattentiveness may be cause for failure of the evaluation at the discretion of the evaluator.
5. Participating decoys will wear protective equipment, as specified by the evaluator, during all patrol events. Also, the decoy will wear preferably civilian training attire, at the evaluator's discretion.

24 FEB 2020

6. The evaluator may exert as much or as little control over the progress of the exercises as he/she deems necessary, including telling the handler when to begin tasks and when they are finished.

7. The team will have one chance to perform each task as described below. Refer to table D-2 for policy on granting an extended validation.

## SECTION II - CONTROLLED AGGRESSION

1. The five tasks of Controlled Aggression may take place in any order, at the evaluator's discretion. The order may be different for every team conducting a validation.

2. The tasks will be performed on a six-foot leash except where noted for pursuits.

3. Throughout the event, the MWD will respond immediately to the handler's commands. There will be no more than one correction per task.

4. All tasks will be performed with a loose leash so that no leash tension, pressure, or corrections are required for performance of the tasks. Instances of leash tension, or pressure, or corrections will be considered faults which will result in failure of the event determined by evaluator discretion.

5. The MWD name can be used to gain the MWD attention prior to a command. The handler may motivate the MWD with verbal praise ("GOOD BOY") so long as it is not a reissue of the command given ("OUT" or "GET'EM").

6. The event begins in a "cold" or "un-agitated" state. Thus, the MWD will not be stimulated or agitated by the decoy prior to the event unless the evaluator calls for it. If the evaluator specifically calls for stimulation/agitation, the MWD will be held by the collar and given the command to "GET'EM" [or "WATCH'EM"] by the handler.

7. If, during the event, the decoy provides excessive stimulation/agitation to the MWD, the evaluator may require that the exercise be repeated with less stimulation.

24 FEB 2020

8. The following reasons will be sufficient to cause failure of the event:

- a. MWD bites the decoy/bite equipment during the Stand-Off.
- b. Team fails to terminate the bite within ten seconds of evaluator instructions to terminate the bite.

**NOTE:** Termination can either be by command "OUT" or by pulling the MWD "off strong" from the decoy.

**Pull off strong** - Physical termination of the bite without a verbal cue. This action will not include vigorous choking or violent activity (striking, beating, kicking etc...).

- c. MWD must exhibit behavior of guard upon "cue".
- Guard** - The action of preventing the decoy from escaping by remaining attentive and present near the decoy. This action can be passive, staring, barking etc... and MWD may contact decoy with his paws or body without biting.
- d. Handler fails to follow the evaluator's instructions.
  - e. MWD fails to re-attack the decoy during an attack on handler in the Search and Re-Attack exercise.

9. Controlled Aggression Tasks

- a. Field Interview. When commanded, MWD will remain in the heel sit, heel standing, or heel down position while the decoy (wearing bite equipment) approaches in a neutral manner to within eight feet of the MWD. Following a brief discussion, the decoy will depart at a full run to a distance of at least 25 yards. The MWD must remain steady at heel, but barking is allowed. The MWD must perform the exercise correctly in one attempt.

- b. Pursuit and Attack. With the MWD in the heel sit, heel standing or heel down position (on-leash), and the decoy at a distance of 25 yards, the decoy will run away.

24 FEB 2020

(1) The MWD should remain steady at heel (but barking is allowed) until the handler begins the warning. Once the warning is begun, the MWD may pull against the collar, and the handler may physically restrain the MWD. After the standard warning ("Halt, halt, halt, or I will release my dog!") is completed, the handler removes the leash, gives the "GET'EM" command, and releases the MWD/collar.

(2) When released the MWD must pursue, give a full bite, and show the ability to hold the bite for a minimum of ten seconds while the decoy struggles/fights.

(3) After ten seconds, the decoy "freezes." The MWD shall maintain its grip until the bite is terminated. Upon termination of the bite the MWD must remain near the decoy (in sit, stand, or down position) and guard the decoy.

c. Stand-Off. With the MWD in the heel sit, heel standing or heel down position (on-leash), and the decoy at a distance of 25 yards, the decoy will run away.

(1) The MWD should remain steady at heel (but barking is allowed) until the handler begins the warning. Once the warning is begun, the MWD may pull against the collar, and the handler may physically restrain the MWD. After the standard warning ("Halt, halt, halt, or I will release my dog!") is completed, the handler removes the leash, gives the "GET'EM" command, and releases the MWD/ collar.

(2) When commanded/released, the MWD must pursue the decoy. The handler will call the MWD "OUT" upon notification from the evaluator). The decoy will stop on the "OUT" command and stand with the protection of the bite equipment facing the MWD.

(3) The MWD must cease the attack and then assume the guard without biting the decoy/bite equipment.

d. Search and Escort

(1) The handler must place himself/herself and the MWD 15 feet from the decoy. This can be done either by heeling the MWD to the correct distance from the decoy (on or off-leash) or by instructing the decoy to place him/herself at the correct distance 15 feet from the MWD and handler. The MWD may be commanded "STAY". The decoy must place him/herself to the

handler and MWD, so that the protected arm is turned somewhat towards the MWD team.

(2) The MWD will then be commanded to "STAY" and the handler will leave the MWD and approach the decoy and physically search him/her, but without obstructing the MWD line of sight to the decoy during the actual search.

(3) Following the search the handler recovers the MWD. If the MWD avoids the handler and the handler must pursue the MWD persistently in order to reach the heel position and recover the MWD, then the MWD fails.

(4) The handler then commands the decoy to move forward, escorting the decoy (back to the starting point for the Pursuit/Stand-Off exercises) from behind at a distance no further than six feet. The MWD can escort the decoy on/off-leash. If a leash is used, excessive leash tension or leash corrections may result in failure, at the evaluator's discretion.

(5) On the evaluator's command the decoy and the team must halt. At this point the decoy withdraws ten or fifteen feet to the side, and then the handler heels the MWD back to the starting point. The MWD should remain at heel and under control.

e. Search and Re-Attack. This event is performed the same as the Search and Escort until the point at which the handler is physically searching the decoy while staying out of the MWD line of sight to the decoy, with the decoy's bite equipment towards the MWD.

(1) The decoy may not make any utterance or give any verbal cue while the decoy attacks the handler, and the handler may not give the "GET'EM" command to the MWD. The decoy may not run away from the MWD after the attack; he/she can stand in position after the attack, struggle with or beat the handler, or turn at the MWD aggressively. The handler may step away from the decoy following the attack in order to minimize the possibility of an accidental bite on the handler.

(2) The MWD must bite and hold for a minimum of ten seconds while the decoy struggles/fights. After at least ten seconds, the decoy "freezes." The MWD will maintain its bite until termination of the bite and guard the decoy.



### SECTION III - INTRUDER DETECTION

Intruder Detection Events. This requirement consists of four events that should be conducted in areas that closely simulate actual tasks required to perform.

1. Building Search. This task will be performed on-leash or off-leash at the handler's discretion by locating one decoy hidden in the building. The evaluator will determine the location of the decoy. The MWD will not be agitated by the decoy prior to the search. The MWD must be prepared to locate a decoy with or without a bite sleeve. The MWD must not attack the decoy unless directed by the evaluator.

a. The MWD will locate the decoy by scent and show a change of behavior (unlike that of the MWD explosive/drug detection response) -- any one or a combination of scratching, biting, barking, or jumping. The decoy will not make any movement or noise until the MWD has given an alert response and the handler has challenged the door.

b. If the MWD exhibits an alert at a location where there is no decoy, the MWD may fail the building search at the evaluator's discretion.

2. Sight Scouting. The MWD must detect a decoy located downwind by sight.

a. The MWD will be on a leash, length optional.

b. The event should be performed in an open area. The decoy will be located 30 yards and out-of-sight of the MWD team.

c. The evaluator will signal the decoy to move in a direction away from the team.

d. At the evaluator's direction, the handler will give the command "FIND'EM".

e. The handler will stop the MWD within ten feet of the decoy.

f. The evaluator will determine if the MWD will receive a bite.

g. The MWD does not locate the decoy, the event is failed.

3. Scent Scouting. The MWD must detect a decoy located upwind by scent.

- a. The MWD will be on a leash, length optional.
- b. The event should be performed in an open area. The decoy will be located 50 yards from the MWD team and in a hidden position.
- c. At the evaluator's direction, the handler will give the command "FIND'EM".
- d. The decoy should reveal his/her position when the MWD approaches no closer than ten feet.
- e. The evaluator will determine if the MWD will receive a bite.
- f. The MWD does not locate the decoy, the event is failed.

4. Sound Scouting. The MWD must detect a decoy located downwind by sound.

- a. The MWD will be on a leash, length optional.
- b. The event should be performed in an open area. The decoy will be located 30 yards from the MWD team and in a hidden position.
- c. The decoy will initiate noise at the evaluator's discretion.
- d. At the evaluator's direction, the handler will give the command "FIND'EM".
- e. The decoy should reveal his/her position when the MWD approaches no closer than ten feet.
- f. The evaluator will determine if the MWD will receive a bite.
- g. The MWD does not locate the decoy, the event is failed.

**TAB D3**

Detector Dog Evaluation Guideline

**Table of Contents**

<u>IDENTIFICATION</u>	<u>TITLE</u>	<u>PAGE</u>
<b>SECTION</b>		
I	General Evaluator Instructions.....	D3-1
II	Evaluation Standards.....	D3-2
III	Team Performance.....	D3-4
IV	Event Location.....	D3-5
V	Drug / Explosive Training Aids.....	D3-5

The content of this tab is intended to support the completion of the Detection Reports:

NAVMC 11818-21 (Detection Validation)

NAVMC 11818-23 (Detection Certification)

**SECTION I - GENERAL EVALUATOR INSTRUCTIONS**

1. The evaluator has discretion to determine the schedule and locations for events that meet the standards of table D-5 (Validation) or D-6 (Certification).
2. The evaluator should use form MC MWD-1 Detection Event Data Sheet to record the key event information while in the field [see Appendix E].
3. The evaluator will select the training aid amount [grams (drug), explosives as packaged] from the approved kits discussed in Section V of this tab. **Justification for not using a required aid is to be noted in the remarks section of the report form.**
4. A handler can only conduct validation or certification with one MWD for a given event.
5. The training aids will be hidden at heights from zero to six feet, and depths from zero to three feet.
6. All training aids must have at a minimum, a 30-minute "sit time" before the MWD begins to search.

24 FEB 2020

7. Ensure that personnel who are handling and placing training aids are not directly involved in the qualification process to minimize residue responses.

8. At least one search event will require the MWD to work at least 20 minutes. The MWD must show the capability to complete the search and will not be allowed a rest-break anytime during the evaluation (exceptions may be made at the discretion of the evaluator).

9. Night Event. A training event conducted in low-light environments, either in/outdoors, when illumination devices, referred to as Night Vision Devices (NVDs), are required (i.e., NVG, flashlight).

10. Buried Aids. Placement must be conducted in accordance with those procedures approved in advance by the base explosives safety and environmental offices as required. Preferred method is to avoid contact with the earth by placing aids in perforated containers (example: ammo cans with drilled holes), buried at the desired depth per table D-5. Disturbed earth distractors should be created in search area.

**NOTE:** For units that are not authorized to conduct training with buried aids, a MFR must be completed and placed in the training records with disapproval letter from base safety denying training.

11. If multiple MWDs in a validation event make a common error (such as false respond in the same location or miss the same training aid) adjustments to the schedule may be made at the evaluator's discretion (i.e., false responses can be ignored, or a problematic aid placement can be "thrown out" and compensated for with an additional aid placement later in the validation). It is not considered a failed event if an aid is "thrown out" or multiple false responses occur in one area.

12. The team will have one chance to perform each task as described below. Refer to table D-2 for policy on granting an extended validation.

## Section II - EVALUATION STANDARDS

1. The handler must show that the MWD can be efficiently separated from the primary reward object. Separation may be accomplished by using a "clean" out on command, by physically

24 FEB 2020

pulling or prying the primary reward from the MWD's mouth, or by "lifting" the MWD off of the reward with leash pressure, so long as physical separation does not result in vigorous choking or gagging or any other sort of violent force being applied to the MWD. If the MWD will not out "cleanly" from the reward, and physical separation requires excessive force, then the team fails the event at the discretion of the evaluator.

2. The MWD must indicate the presence of odor using a passive response (also called final response). The passive final response should normally be a sit. A down or "stop & stare" may also be counted as a correct final response if the MWD is unable to sit due to a physical barrier.

3. An MWD making an "aggressive" response during the event will be cause for failure of the event. A response is considered "aggressive" when the MWD attempts to bite/ scratch/ excessively nudge the training aid or area containing the training aid. Barking is not considered aggressive behavior. MWD should be encouraged to final respond at a door rather than use aggressive behavior in the attempt to enter an area.

4. Correct Detection Responses or Hits. A correct response or "hit" is normally defined as an unassisted or "uncued" final response within a radius of six feet of odor source.

a. The MWD should final respond as close to the odor source as possible, taking into account any intervening obstacles, barriers, etc. If the MWD exhibits such an optimally correct final response, the evaluator will immediately tell the handler "Yes."

b. In the event that the evaluator believes the MWD can and should move closer to the training aid, he/she will tell the handler "Not at Source", and direct the handler to take appropriate action (i.e., praise the MWD, encourage it to work closer to source, and if necessary assist the MWD to pinpoint the aid and emit the final response). It should be understood that the words "Not at Source" denote a correct final response, or hit. Any additional attempts to induce the MWD to move closer to source prior to rewarding the animal are merely to benefit the animal's training.

c. Only a positive response [annotated in WDMS as "+"] will be counted as a "hit", as defined above, in the accuracy computation for a detection validation or certification. An assisted positive response [annotated in WDMS as "(+)"] is

included in the total number of trials conducted, but not counted as an acceptable "hit" in the qualification process.

5. Fringe Responses. If an MWD gives a final response at a distance greater than six feet from the training aid, and/or on an unexpected side of a physical obstacle, this may be declared a correct response at the evaluator's discretion. Any correct detection responses occurring at a distance greater than six feet from training aids (under circumstances in which it is still possible for the MWD to move closer to the training aid) will be considered fringe responses.

In the event of a fringe response, the evaluator will tell the handler "Fringe", and direct the handler to take appropriate action (i.e., praise the MWD, encourage it to work closer to source, and if necessary assist the MWD to pinpoint the aid and give a final response). Whether or not the evaluator defines the response as a correct response will depend on whether the MWD exhibited a distinct change of behavior prior to the response, whether other MWDs in the evaluation exhibit changes of behavior in approximately the same area, and how efficiently the MWD responds to encouragement to pinpoint the training aid.

6. False Responses. A false response is defined as a final response with no training aid present. If the MWD gives a false response, the evaluator will tell the handler "NO" and instruct the handler to move out of the immediate area and continue the search.

### Section III - TEAM PERFORMANCE

1. The team may search by the following methods:
  - Scan the area
  - Systematic presentations of productive areas
  - Detailed scan of the area

2. The handler has one attempt to clear each area. Once the handler has deemed the area clear rechecking that area will not be allowed unless the MWD "pulls" the handler back to that area.

**NOTE:** Only one response will be recorded per task. Multiple responses must be approved by the evaluator and justified in the comments section of the reporting form.

## Section IV - EVENT LOCATION

A selection of following locations should be used for detection events, as available [same terminology as recorded in WDMS]:

- **Aircraft**, interior and/or exterior
- **Baggage (minimum of 20 pieces)**
- **Barracks (minimum of 15 rooms)**. Doors to rooms may be opened and/or closed.
- **Building**
- **Cargo** [ISO container, PALCON, QUADCON, etc.]
- **Hangar**
- **Open area**
- **Overpass/Bridge**
- **Roadway** [same as term "Route"]
- **Tunnel/Bunker**
- **Vehicles (minimum of 25)**. Doors, windows, hoods, trunks and other compartments may be opened or closed.
- **Warehouse**
- **Watercraft**

### NOTE

Since some MWD sections may not have access to above minimum quantities, use what is available for val/cert events.

## Section V - EXPLOSIVE / DRUG TRAINING AIDS

1. The detection training aids used for the qualification process will be those contained in the USMC approved scent kits and listed in the validation/certification report. Residual odor cannot be used.
2. Not using a required detection scent must be justified in the comments section of the WDMS team data entry for validation/certification events.
3. Not utilizing all of the required odors will result in a limited validation and a restricted team readiness status.
4. Refer to the following Order references for further details about authorized detection training aids:
  - a. Chapter 11 - Drug Training Aids.
  - b. Chapter 12 - Explosive Training Aids.

**TAB D4**

Specialized Search Dog Evaluation Guideline

**Table of Contents**

<u>IDENTIFICATION</u>	<u>TITLE</u>	<u>PAGE</u>
<b>SECTION</b>		
I	General Evaluator Instructions.....	D4-1
II	Evaluation Standards.....	D4-3
III	Team Performance.....	D4-4
IV	Event Location.....	D4-6
V	Explosive Training Aids.....	D4-10
<b>FIGURES</b>		
D4-1	Directional Search Visual & Verbal Commands.....	D4-5
D4-2	Box Pattern Search.....	D4-6
D4-3	Verging Pattern Search.....	D4-7
D4-4	Quartering Pattern Search.....	D4-8
<b>TABLES</b>		
D4-1	Detection Search Techniques.....	D4-9
D4-2	SSD Off-Leash Vehicle Search Scenarios.	D4-9

The content of this tab is intended to support the completion of the Detection Reports as they apply for SSD:

- NAVMC 11818-21 (Detection Validation)
- NAVMC 11818-23 (Detection Certification)

**SECTION I - GENERAL EVALUATOR INSTRUCTIONS**

1. The evaluator has discretion to determine the schedule and locations for events that meet the standards of table D-5 (Validation) or D-6 (Certification).
2. All detection events will be conducted off-leash.
3. The evaluator should use form MC MWD-1 Detection Event Data Sheet to record the key event information while in the field [see Appendix E].
4. The handler must ensure that all areas are searched completely and must notify the evaluator if an area cannot be searched due to safety. If a handler fails to completely search



an area, the team fails the event and an extended may be granted.

5. The handler must be able to brief the evaluator on the capabilities, limitations, and security procedures to take if the team comes under contact or the MWD shows a change of behavior during the validation. Inability to conduct the brief will be grounds for failure at the evaluator's discretion.

6. The MWD should give a final response when at source of a known odor, however; if the handler identifies the definitive change of behavior and points out the aid location to the evaluator constitutes a successful find. If the handler incorrectly declares a positive response it will be considered false response.

7. The evaluator will determine which of the following search areas will be used: [Refer to **Section IV** for details about conducting events in each of the search areas.]

a. Route (urban/rural). Includes railways, trails, and over passes. [**NOTE:** This search includes Roadways and Overhead/Bridges as recorded in WDMS]

b. Open Area (urban/rural). There is a distinct difference between rural and urban open areas and each has unique characteristics.

c. Building (unoccupied). Minimum 15 rooms - exterior/interior. [**NOTE:** This search includes Barracks, Building, School, and Theater as recorded in WDMS]

d. Vehicles. Single and multiple search

8. The team will have one chance to perform each task as described below. Refer to table D-2 for policy on granting an extended validation.

9. Night Event. Night events include all those conducted in low-light environments, either in/outdoors, when illumination devices, referred to as Night Vision Devices (NVDs), are required (i.e., NVG, flashlight).

10. Buried Aids. Placement must be conducted in accordance with those procedures approved in advance by the base explosives safety and environmental offices as required. Preferred method is to avoid contact with the earth by placing aids in perforated

24 FEB 2020

containers (example: ammo cans with drilled holes), buried at the desired depth per table D-5. Disturbed earth distractors should be created in the search area.

**NOTE:** For units that are not authorized to conduct training with buried aids, a MFR must be completed and placed in the training records with disapproval letter from base safety denying training.

## SECTION II - EVALUATION STANDARDS

1. The MWD must indicate the presence and location of the training aid using a positive response (also called final response). Before the search is determined "complete" by the handler, he/she may revisit a given area manipulate the MWD until the entire area has been searched.
2. If the handler fails to manipulate the MWD to a specific area deemed productive, this constitutes a failure.
3. If the MWD is properly manipulated to all productive areas and fails to indicate the location of odor, this constitutes a failure.
4. An MWD making an "aggressive" response during the event will fail the evaluation. A response is considered "aggressive" when the MWD attempts to bite/ scratch/ excessively nudge the training aid or area containing the training aid. Barking is not considered as aggressive behavior.
5. **Correct Detection Responses or Hits.** A correct response or hit is normally defined as an unassisted or "uncued" final response within a radius of **six feet** of odor source.
  - a. In principle the MWD should final respond as close to the odor source as possible, taking into account any intervening obstacles, barriers, excessive amounts of odor, etc. If the MWD exhibits such an optimally correct final response, the evaluator will immediately tell the handler.
  - b. In the event that the evaluator believes the MWD can and should move closer to the training aid, he/she will tell the handler "Not at Source", and direct the handler to take appropriate action (i.e., praise the MWD, encourage it to work closer to source, and if necessary assist the MWD to pinpoint

the aid and execute the final response). It should be understood that the words "Not at Source" denote a correct final response, or hit. Any additional attempts to induce the MWD to move closer to source prior to rewarding the animal are merely to benefit the animal's training.

c. Only a positive response [annotated in WDMS as "+"] will be counted as a "hit", as defined above, in the accuracy computation for a detection validation or certification. An **assisted positive response** [annotated in WDMS as "(+)"] is included in the total number of trials conducted, but **not counted** as an acceptable "hit" in the qualification process.

**NOTE:** Only one response will be recorded per task. Multiple responses must be approved by the evaluator and justified in the comments section of the reporting form.

6. False Responses. A false response is defined as a final response with no training aid present. If the MWD emits a false response, the evaluator will tell the handler "NO" and instruct the handler to move out of the immediate area and continue the search.

### SECTION III - TEAM PERFORMANCE

1. The handler has one attempt to clear each area.
2. Once the handler has declared an area cleared constitutes his/her one attempt. Rechecking that area will not be allowed unless the MWD "pulls" the handler back to that area.
3. During the detection event, the evaluator will note if all of the following directional maneuvers are effectively executed by the team. Failure to successfully perform any of the following maneuvers will be the basis for the evaluator to terminate the event at any time and award a failure to the team.
4. Successful Maneuver. During the validation process, the evaluator must observe the MWD team consistently executing all of the following commands correctly:
  - a. Direction. The following commands must be completed with no more than three corrections from the handler per command [see figure D4-1 below for correct visual signal to be used with the

verbal command] traveling in the direction commanded without significant deviation, at the evaluator's discretion.

- Moving forward and searching ["BACK"]
- Searching moving left and right ["LEFT" and "RIGHT"]
- Searching moving back to the handler ["HERE"]

**Note:** The commands "BACK" and "HERE" are currently used in USMC training as most SSDs are purchased knowing these commands. However, the Joint Service CPD for the family of MWDs uses "FORWARD" and "COME" instead. (For further information, refer to LAFB 375c for commands the SSD was qualified on.)

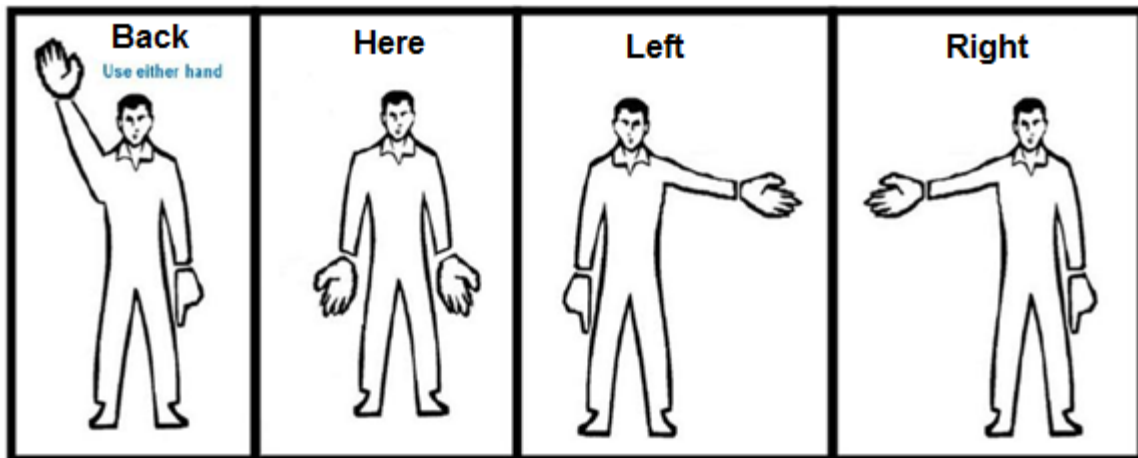

Figure D4-1.--Directional Search Visual & Verbal Commands

b. Immediate Stop. The following command must be completed with no more than three corrections from the handler:

["DOWN" or "SIT" or "STAY" as indicated on the LAFB 375]

c. Emergency/Immediate Recall. The following command must be completed with no more than three corrections from the handler:

["YES"] - MWD leaves odor and moves immediately toward handler who will give the command "HEEL" when the MWD is within 30 meters.

## SECTION IV - EVENT LOCATION

1. Route [Off-Leash]. A route search for validation will be a minimum of **200 meters**. The training aids will be hidden no less than **75 meters**. The distance does not have to be searched in one bound. The handler must assess the situation and search the route based on the MWD capabilities; i.e., **verging pattern** or **boxing pattern**, covering a minimum of 30 meters at a time. The evaluator will present the event mission to the team as a scenario simulating a real-world situation. The handler will be given time to ask questions and formulate a plan [e.g., considering the wind, Winthrop points, terrain] to accomplish the mission making best use of the MWD while respecting sound tactical principles. The handler must maintain control during the search.

a. Box Pattern. Start on one side of the route, on the downwind side if feasible. Send MWD "BACK" approximately 30 meters, command MWD to cross to the other side of the road and search back ["HERE"] to your starting point. Team will advance 75% percent of the first box and start the second box/bound. Continue patterns until the entire route is searched (see figure D4-2).

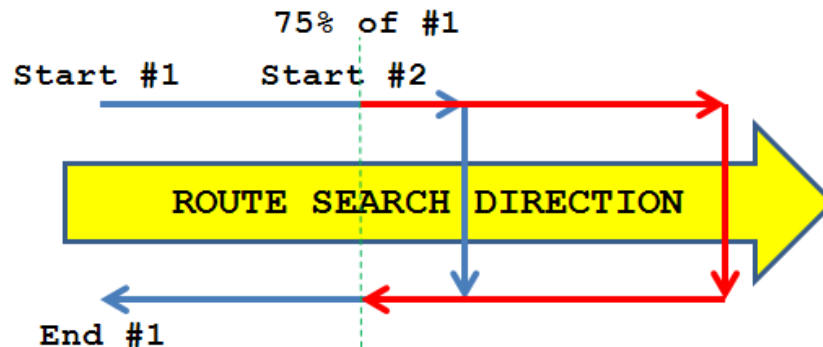

Figure D4-2.--Box Pattern Search

b. Verging Pattern. Standing on one side of the route, send MWD "BACK" a minimum of 30 meters, and reverse the search ["HERE"] on the same route side back to the starting point. Cross over to the other side and repeat the same steps. Team will advance 75% percent of the first verge and start the second verge bound. Continue patterns until the entire route is searched (see figure D4-3).

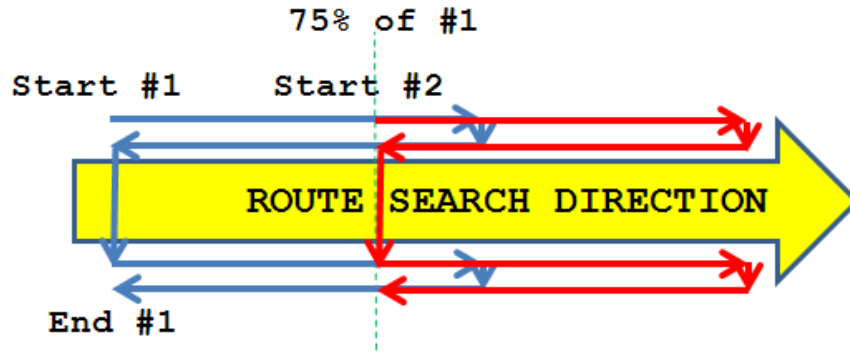

Figure D4-3.--Verging Pattern Search

2. Open Area [Off-Leash]. In open area search events, the training aids will be hidden no less than **75** meters from the starting line within a **one acre search area** [approximately 200 x 200 meter area]. The evaluator will present the event mission to the team as a scenario simulating a real-world situation. The handler will be given time to ask questions and formulate a plan [considering the wind, Winthrop points, terrain, etc.] to accomplish the mission making best use of the MWD while respecting sound tactical principles. The evaluator will then move the team to the starting point to start the search process, ideally, the likely avenue of approach (entrance of the area to be searched). The evaluator will signal the handler to start the search at which time the evaluator will note the start time, if a time limit has been placed on the search scenario. The handler must maintain control using a quartering pattern. Quartering pattern, is standing at the side of the search area, send the MWD "BACK" into the wind. As the handler moves forward in the cleared center lane, direct the MWD to the left and right to clear an area of 30 meters wide (minimum). Repeat the pattern as illustrated in figure D4-4 until the area is cleared:

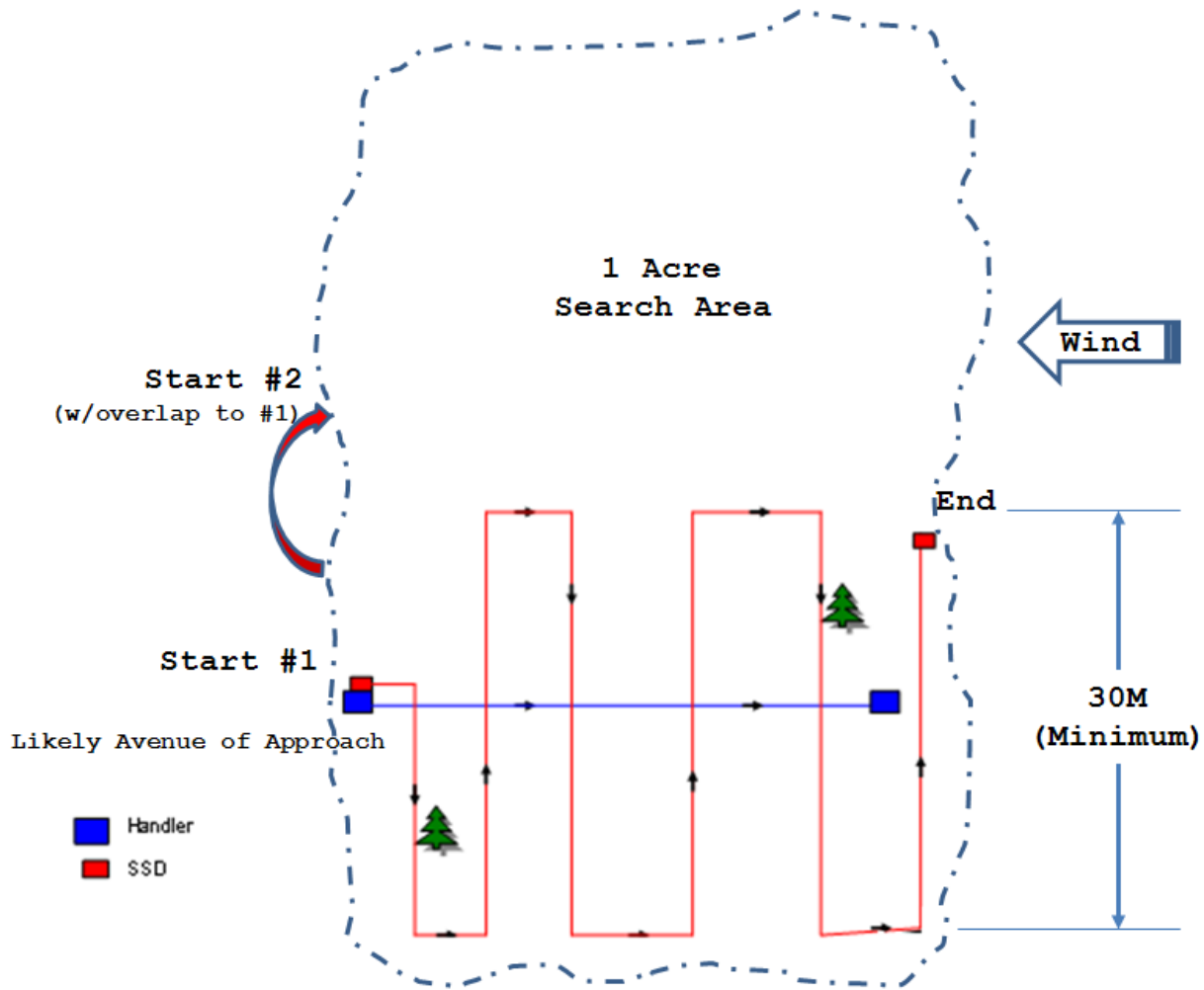

Figure D4-4.--Quartering Pattern Search

### 3. Building [Off-Leash]

a. The search will begin at the outside perimeter then continue inside the building.

b. Buildings are used for hiding arms and explosives in wall cavities, roofs, and floor spaces. They may also be laid under rubble. MWD can be sent to the exterior of the building from a distance to provide scan of the immediate area. The team will then search each door seam prior to entering the room. Once MWD searches the door seam, the handler will conduct a quick pre-search assessment; identifying hazards or suspicious area and allowing the handler to establish a search plan.

c. Any combination of the search patterns described in table D4-1 can be used at the handler's discretion.

<b>Table D4-1.--Detection Search Techniques</b>	
<b>Technique (alternate name)</b>	<b>Description</b>
Scan (Free)	When given the command "SEEK" the MWD will initiate odor search by scanning the area.
Detailed (Systematic)	When given the command "SEEK" the MWD will follow hand presentations to a specific point and initiate odor search.

#### 4. Vehicle [Off-Leash]

Vehicle search will be a combination of the off-leash scenarios described in table D4-2 for a total of 15 vehicles (min).

<b>Table D4-2.--SSD Off-Leash Vehicle Search Scenarios</b>	
<b>Number of Vehicles</b>	<b>Event Description</b>
Single	Conduct scan search consisting of a 360-degree search around the exterior of a single vehicle located ten to twenty meters from start point. Maximum of three minutes to direct the SSD and complete the search while the handler remains at a ten meter standoff (min).
Multiple	Conduct scan search consisting of a 360-degree search around the exterior of five vehicles with the first located ten meters from the start point and the other spaced two meters apart in straight line. Maximum of five minutes to direct the SSD and complete the search while the handler remains at a ten meter standoff (min).
Any Number	Conduct detailed search of the vehicle exterior while handler makes hand presentations on productive area. Evaluator determines if search time is reasonable for scenario.

## **Section V - EXPLOSIVE TRAINING AIDS**

1. The detection training aids used for the qualification process will be those contained in the USMC approved scent kits



24 FEB 2020

and listed in the validation/certification report. Residual odor cannot be used.

2. **Not using a required detection scent** must be justified in the comments section of the WDMS team data entry for validation/certification events.

3. Not utilizing all of the required odors will result in a **limited** validation and a **restricted** team readiness status.

4. Refer to Chapter 12 [Explosive Training Aids] in this Order for further details.

**TAB D5**

Combat Tracker Dog Evaluation Guideline

**Table of Contents**

<u>IDENTIFICATION</u>	<u>TITLE</u>	<u>PAGE</u>
<b>SECTION</b>		
I	General Evaluator Instructions.....	D5-1
II	Handler Instructions.....	D5-3
III	Quarry Instructions.....	D5-4
<b>FIGURES</b>		
D5-1	Deliberate Movements.....	D5-2
D5-2	Tracking Techniques.....	D5-4

The content of this tab is intended to support the completion of the following form:  
NAVMC 11818-22 [Tracking Validation Report]

**SECTION I - GENERAL EVALUATOR INSTRUCTIONS**

1. The evaluator at all times has discretion to determine the schedule and locations for events that meet the standards of table D-5 (Validation).
2. The evaluator should use form MC MWD-2 Tracking Event Data Sheet to record the key track information while in the field [see Appendix E].
3. The objective of a tracking event is to ensure that the MWD can effectively track in both Rural and Urban Areas as defined below:
  - a. Rural track should be, but not limited to, a low populated area, open fields, wooded areas, etc.
  - b. Urban Area track should be, but not limited to, high populated areas, housing, parking lots, and industrial areas with multiple surfaces.
4. At the evaluator's discretion, the following variables will be incorporated into track:

- a. Distraction. Any variable added to distract the MWD; e.g., cross tracks, gunfire, people, dogs/animals and vehicles/vehicles horns.
- b. Deliberate Movement. Any of the quarry movements illustrated in figure D5-1:

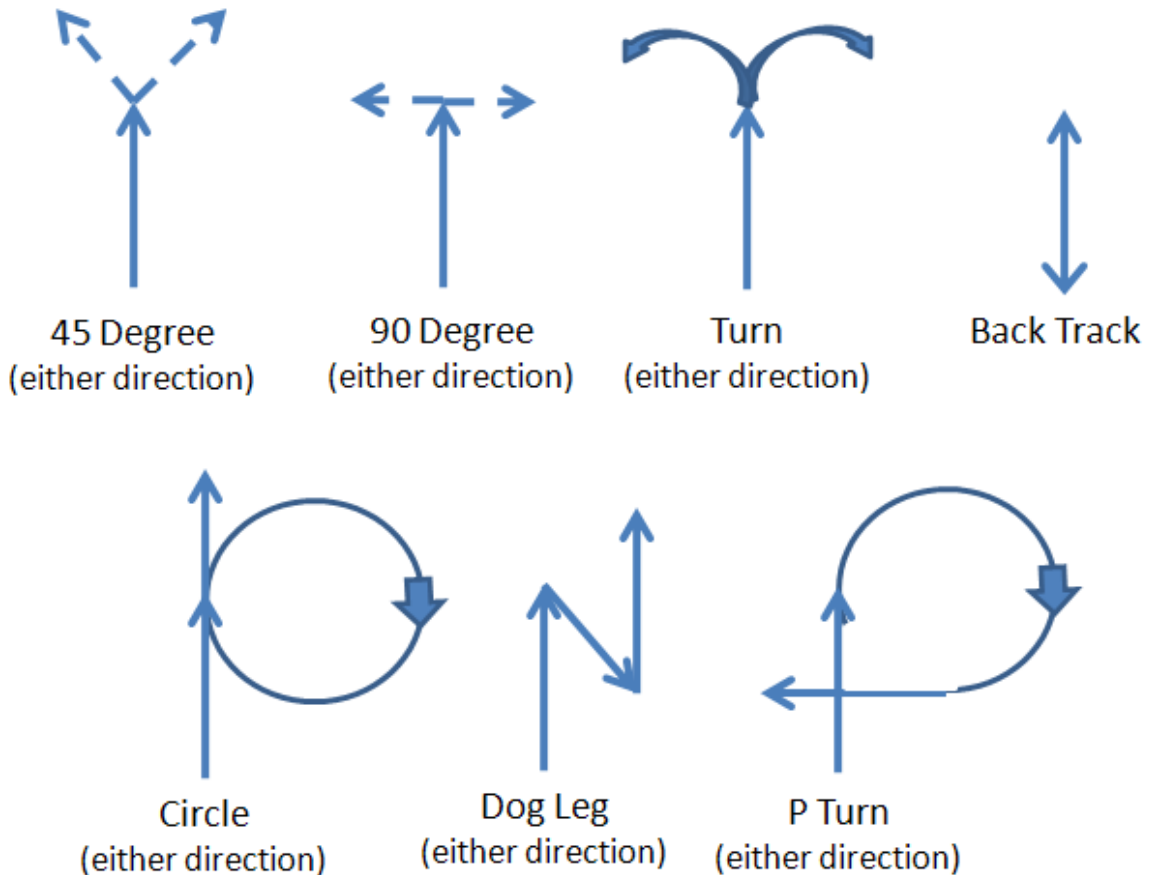

Figure D5-1.--Deliberate Movements

- c. Obstacle/Barrier. Water, fences, logs, or any obstacle in the obstacle course, etc.
  - d. Surface. Any place the MWD can walk; e.g., dirt, gravel and asphalt/concrete roads, parking lots and sidewalks.
5. The age of a track starts when the quarry starts moving or lays a scent pad.
6. When the quarry has completed laying the Rural track, the evaluator will lead the team to the general area of the scent pad.

7. When the quarry has completed laying the **Urban/Commercial** track, the evaluator will lead the team to the scent pad.
8. Once the track is located, the team will continue to the end point where the quarry will be present or till the evaluator terminates the track.
9. Once the quarry is located or the MWD gives a significant change of behavior; at the evaluator's discretion, the handler can reward the MWD by verbal and physical praise.
10. Failure to locate the quarry will constitute a failed event. Refer to table D-2 for policy on granting an extended validation.

**NOTE**

For a CTD, trailing is normally considered a performance deficiency unless the MWD is within close enough proximity to the quarry to warrant an "alert" or there is physical odor above ground level, for example blood or other physical scent producers rubbed above ground level.

## **SECTION II - HANDLER INSTRUCTIONS**

**The Handler should:**

1. Utilize any leash longer than six feet, some collar and a nylon/leather tracking harness.
2. Utilize NVGs for the night events.
3. Carry a water source for the handler and MWD.
4. Utilize the tracking methods, illustrated in figure D5-2, to find the track at his/her discretion:

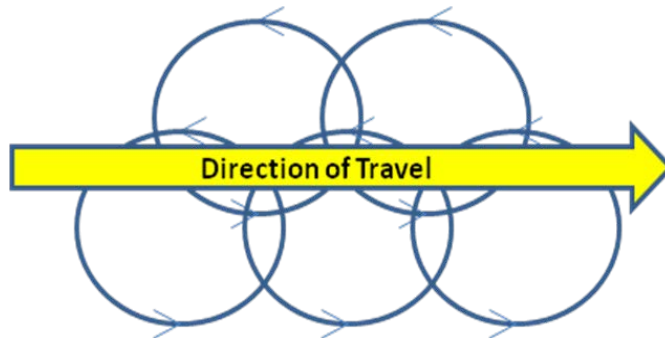

**Concentric Circles** - over lapping circles pattern.



**Figure Eights** - figure eight pattern.

Figure D5-2.-Tracking Techniques

### SECTION III - QUARRY INSTRUCTIONS

**The quarry should:**

1. Wear preferably civilian training attire, at the evaluator's discretion.
2. Use a GPS device to track his/her location for accuracy.
3. Maintain communication with the evaluator during the track.
4. Travel at a walk, jog and run while laying the track. The minimum time/distance to jog will be the evaluator's discretion depending on the number of surfaces to be covered.
5. Remain at the end of the track.
6. Not carry any type of reward object (ball, kong or wrap) on his/her person, while laying the track unless otherwise instructed by evaluator.
7. Not leave any type of scent or reinforcements article on any portion of the track; i.e., clothing and keys.

**APPENDIX E**

Forms and Reports

1. Purpose. To provide sourcing information, examples and completion instructions (where applicable) to assist in the effective use of those preformatted, officially designated documents directly associated with MWD activities and referenced in this Order. These documents are listed in table E-1.

<b>Table E-1.--MWD Program Designated Documents</b>				
<b>Form Reference Number</b>	<b>Description</b>	<b>Where Filed</b>	<b>Reference in Manual</b>	<b>Appendix Sample Page</b>
LAFB 375	MWD Qualifications (Patrol, Detection, CTD, SSD Detection, SSD Obedience/Control)	MWD Svc Folder	5203.2 7402.2 8106.2 Table 8-5 11010	E-5
DD 200	Financial Liability Investigation of Property Loss	Expl Aid Acct Folder	Table 8-9 12307.2	See Note
DD 626	Motor Vehicle Inspection Report (Transporting Hazardous Materials)	w/Trip Ticket	12306.3	See Note
DD 1348-1A	Issue Release/Receipt Document	Unit Supply	8202.1 8203.2 12102.4/7 12308.1 12309.2	See Note
DD 1391	Military Construction Project Data Sheet	Ops Binder	9003.4	See Note
DD 1610	Request And Authorization For TDY Travel Of DoD Personnel	MWD Svc Folder	8203.2/3	See Note
DD 1626	Veterinary Necropsy Report	MWD Med Folder	Table 10-2	See Note
DD 1741	Military Dog Immunization Record	MWD Med Folder	Table 10-2	See Note
DD 1743	Death Certificate of MWD	MWD Med Folder	Table 8-9 Table 10-2	See Note
DD 1829	Record of Military Dog Physical Examination	MWD Med Folder	Table 10-2	See Note
DD 1834	MWD Service Record	MWD Svc Folder	5703.2 7403.2 8103.2 8104.1 8106.2 Table 8-7 Table 8-9 12011	E-8
DD 2209	Veterinary Health Certificate	MWD Med Folder	8203.2 Table 10-2	See Note
DD 2342	Animal Facility Checklist	MWD Med Folder	Table 8-8 Table 10-2	See Note

24 FEB 2020

<b>Table E-1.--MWD Program Designated Documents</b>				
<b>Form Reference Number</b>	<b>Description</b>	<b>Where Filed</b>	<b>Reference in Manual</b>	<b>Appendix Sample Page</b>
DD 2875	System Authorization Access Request (SAAR)	Digital copy only	8003.3	E-9
DEA 106	Report of Theft or Loss of Controlled Substances	Drug Acct Folder	11408.3	See Note
DEA 222	Controlled Substance Order Form For Schedules I & II	Drug Acct Folder	12202.3/4 11402.1 11410.2/5	<b>Form Not Online</b> Instructions in CFR Title 21, Part 1305, Sub Part B
DEA 223	Controlled Substance Registration Certificate	On Drug Safe	13302.1 11403.2 11407.3 11408.1 11505	See Note
DEA 225	Application For Registration	Drug Acct Folder	11301.1	See Note
DEA 225A	Renewal Application For Registration	Drug Acct Folder	11407.2 11408.1	See Note
MC MWD-1	Detection Event Data Worksheet	N/A	8104.1 12304.8 App D3 App D4	E-10
MC MWD-2	Tracking Event Data Worksheet	N/A	8104.1 App D3	E-11
MC MWD-3	Food, Weight, Stool Report	At Kennel Door	10003 10005.3 10204.2	E-12
MC MWD-4	MWD Section Command Chronology Report	Ops Binder	8104.2	E-13
MC MWD-5	Canine Explosive Authorization Package (CEAP) Data Card	CEAP Storage Box	12102.7 12309.5 App M	E-15
MC MWD-6	USMC Commander's Guide for MWD Capabilities trifold	N/A	3403.3e	See Note
MC MWD-7	USMC MWD Program Handbook for Non-Operational Federal Missions	N/A	6304	See Note
MC MWD-8A	USMC Commander's Guide to MWD Team Qualification & Operational Readiness at Supporting Establishments (SE) trifold	N/A	3403.3e	See Note

24 FEB 2020

<b>Table E-1.--MWD Program Designated Documents</b>				
<b>Form Reference Number</b>	<b>Description</b>	<b>Where Filed</b>	<b>Reference in Manual</b>	<b>Appendix Sample Page</b>
MC MWD-8B	USMC Commander's Guide to MWD Team Qualification & Operational Readiness at Law Enforcement Battalions (LE Bn) trifold	N/A	3403.3e	See Note
MC MWD-9	Record Folders Checklists	N/A	8106.3	See Note
NAVMC 10627	Vehicle and Equipment Record	w/Trip Ticket	12306.3	See Note
NAVMC 10765A	Ammunition Magazine Data Card	CEAP Storage Box	12309.5	See Note
NAVMC 11130	Statement of Force/Use of Detention Space (1630)	MWD Svc Folder	6109.1 6110.1	See Note
NAVMC 11381	Class V(W) Expenditure Report	Expl Acct Folder	12102.6 12308.1	See Note
NAVMC 11797	Notice of Delegation of Authority (DOA) to Request, Approve and Receive Class V(W)	Expl Acct Folder	12102.5 12202.2/4/5 12203.1	See Note [example in Fig 12-2]
NAVMC 11818-1	MWD Activity Report	MWD Svc Folder	5203.7 5204.9 5205.7 8104.1/2	E-16
NAVMC 11818-19	Basic Skills Validation Report	MWD Svc Folder	5204.9 Table 8-6 App D1	E-32
NAVMC 11818-20	Patrol Validation Report	MWD Svc Folder	5204.9 Table 8-6 App D2	E-33
NAVMC 11818-21	Detection Validation Report	MWD Svc Folder	5204.9 Table 8-6 App D3 App D4	E-34
NAVMC 11818-22	Tracking Validation Report	MWD Svc Folder	5204.9 Table 8-6 App D5	E-35
NAVMC 11818-23	Detection Certification Report	MWD Svc Folder	5205.2/7 8105.2/3 App D3 App D4	E-36
OPNAV 5580/1	Incident Complaint Report (ICR)	MWD Svc Folder	6109.1	See Note
SF 600	Health Record, Chronological Record of Medical Care	MWD Med Folder	Table 10-2	See Note



24 FEB 2020

Table E-1.--MWD Program Designated Documents				
Form Reference Number	Description	Where Filed	Reference in Manual	Appendix Sample Page
<b>NOTES:</b>				
Forms can be found at the following sources:				
LAFB - only available from the 341 TRS, JBSA-Lackland				
DD - instructions on website <a href="https://www.esd.whs.mil/Directives/forms/">https://www.esd.whs.mil/Directives/forms/</a>				
DEA - <a href="https://www.deadiversion.usdoj.gov/online_forms_apps.html">https://www.deadiversion.usdoj.gov/online_forms_apps.html</a>				
[instructions on website][ <b>Except DEA 222 &amp; 223</b> ]				
DEA 223 -				
<a href="https://apps.deadiversion.usdoj.gov/webforms/dupeCertLogin.jsp">https://apps.deadiversion.usdoj.gov/webforms/dupeCertLogin.jsp</a>				
MC - [MC MWD 1-3, 5 digital forms, MC MWD-6,8A & 8B trifolds, MC MWD-7 handbook, and MC MWD-9 checklists are in the WDMS library at				
<a href="https://WDMS.CCE.AF.MIL">https://WDMS.CCE.AF.MIL</a> ]				
[MC MWD-4 is generated WDMS report]				
OPNAV / NAVMC - instructions on website				
<a href="https://forms.documentservices.dla.mil/">https://forms.documentservices.dla.mil/</a>				
<b>NOTE: All NAVMC 11818 series forms only available in WDMS</b>				
SF - <a href="https://www.gsa.gov/reference/forms">https://www.gsa.gov/reference/forms</a> [instructions on website]				

2. Effective Use Date. These forms and reports can be used until specifically superseded or cancelled by the sources identified in the notes of table E-1.

3. Sample Forms and Reports. Documents are presented in the sequence listed in table E-1. Instructions are provided where applicable.

PATROL DOG QUALIFICATION						
TO			FROM			
NAME OF DOG	BRAND NUMBER	WHELP DATE	BREED	SEX		
NAME AND GRADE OF TRAINER		SIGNATURE				
PATROL DOG EVALUATION (ALL TASKS CONDUCTED ON LEASH UNLESS OTHERWISE SPECIFIED)						
Command	Pass	Fail	Command	Pass	Fail	
TUNNELS #1			MURKLE #1			
#2			#2			
#3			#3			
DOG WALK			WINDOW			
STEPS / STAIRS			"A" FRAME			
OBEDIENCE						
"MARCHING"			"DOWN" (EOL)			
"DOWN" (AT HEEL)			"BIT" (EOL)			
"BIT" (AT HEEL)			"HEEL" (EOL)			
"STAY" (EOL)			GUNFIRE HANDLER/EVALUATOR			
FIELD INTERVIEW (ON LEASH)			MAINTAINS GUARD POSITION			
ATTACK (OFF LEASH)			GUARD POSITION			
"PURSUIT"			"SIT / DOWN / STAND"			
"BITE"			SEARCH (OFF LEASH)			
"OUT"			MAINTAINS GUARD POSITION			
MAINTAINS GUARD POSITION			RE-ATTACK			
GUARD POSITION			"BIT"			
"SIT / DOWN / STAND"			"OUT"			
SEARCH (OFF LEASH)			MAINTAINS GUARD POSITION			
MAINTAINS GUARD POSITION			SCOUT			
ESCORT (ON LEASH)			SIGHT / SOUND / SCENT			
STAND OFF			LOCATE DECOY			
FIELD INTERVIEW (ON LEASH)			DISTANCE OF RESPONSE			
STAND OFF (OFF LEASH)			BUILDING SEARCH			
"PURSUIT"			BUILDING SEARCH RESPONSE TYPE			
"OUT" (STOPS PURSUIT)						
QUALIFICATION DATA						
NOMENCLATURE		DATE		QUALIFIED OR ELIMINATED		
DAYS IN TRAINING	DAYS NOT TRAINED	TOTAL DAYS IN TRAINING	DATE ENTERED PATROL TRAINING			
DISPOSITION						
TYPE NAME, GRADE, AND TITLE OF TRAINING SUPERVISOR		SIGNATURE				
TYPE NAME, GRADE, AND TITLE OF EVALUATOR		SIGNATURE				
TYPE NAME, GRADE, AND TITLE OF COMMANDER		SIGNATURE				
REMARKS:						

LACKLAND AFB FORM 375 VS, MAY 2017 (PREVIOUS EDITION IS OBSOLETE)

LAFB 375	Patrol Dog Qualification
<ul style="list-style-type: none"> <li>• Three-page document containing qualification information from the initial patrol dog training organization.</li> <li>• Establishes a performance baseline.</li> <li>• Completed by the 341 TRS, JBASA-Lackland.</li> </ul>	

DETECTOR DOG QUALIFICATION						
TO			FROM			
341 TRS/DOLM			341 TRS/DOOM			
NAME OF DOG	BRAND NUMBER	WHELP DATE	BREED	SEX		
NAME AND GRADE OF TRAINER		SIGNATURE				
NAME AND GRADE OF TRAINING SUPERVISOR		SIGNATURE				
EXPLOSIVE ODORS						
AMMONIA DYNAMITE	AMMONIUM NITRATE	C-4				
TNT	DETONATION CORD	WATER GEL				
SMOKELESS POWDER	POTASSIUM CHLORATE	SODIUM CHLORATE				
OTHER (SPECIFY)						
DRUG ODORS						
COCAINE	MDMA	HEROIN	MARIJUANA			
OTHER (SPECIFY)						
DETECTOR DOG EVALUATION INFORMATION						
AREA USED	AMOUNT/TYPE OF SUBSTANCE	DATE	SEARCH TIME	AID HEIGHT	AID DEPTH	
QUALIFICATION DATA						
NOMENCLATURE		DATE		QUALIFIED OR ELIMINATED		
DAYS IN TRAINING	DAYS NOT TRAINED	TOTAL DAYS IN TRAINING				
DATE ENTERED TRAINING	DETECTOR RESPONSE/REWARD	DISPOSITION				
TYPE NAME, GRADE, AND TITLE OF EVALUATOR		SIGNATURE				
TYPE NAME, GRADE, AND TITLE OF COMMANDER		SIGNATURE				
REMARKS						

LACKLAND AFB FORM 375 OCT 2017 (PREVIOUS EDITION IS OBSOLETE)

LAFB 375	Detector Dog Qualification
<ul style="list-style-type: none"> <li>• Three-page document containing qualification information from the initial detection dog training organization.</li> <li>• Used for both drug and explosive detection.</li> <li>• Establishes a performance baseline.</li> <li>• Completed by the 341 TRS, JBASA-Lackland.</li> <li>• <b>Note:</b> Used to be called LAFB 375a.</li> </ul>	

TRACKING DOG QUALIFICATION					
TO 341 TRS/DOLM		FROM 341 TRS/DOOC			
NAME OF DOG	BRAND NUMBER	WHELP DATE	BREED	SEX	
NAME AND GRADE OF TRAINER		SIGNATURE			
TRACKING EVALUATION (ALL ITEMS CONDUCTED ON LEASH UNLESS OTHERWISE SPECIFIED)					
TASK	Pass	Fail	Command	Pass	Fail
Track _____ Meters (Rural)	<input type="checkbox"/>	<input type="checkbox"/>	Track 200 Meters (Urban)	<input type="checkbox"/>	<input type="checkbox"/>
Track Completed in _____	<input type="checkbox"/>	<input type="checkbox"/>	Track Completed in _____	<input type="checkbox"/>	<input type="checkbox"/>
4 - 7 Turns (Rural)	<input type="checkbox"/>	<input type="checkbox"/>	Turn 1 (Urban)	<input type="checkbox"/>	<input type="checkbox"/>
Tracking during gunfire	<input type="checkbox"/>	<input type="checkbox"/>	2 rounds fired by Handler	<input type="checkbox"/>	<input type="checkbox"/>
2 rounds fired at a distance of 30 Meters from CTD Team	<input type="checkbox"/>	<input type="checkbox"/>	Navigation of agility course	<input type="checkbox"/>	<input type="checkbox"/>
Obedience Evaluation (ALL ITEMS CONDUCTED ON LEASH UNLESS OTHERWISE SPECIFIED)					
"Sit"	<input type="checkbox"/>	<input type="checkbox"/>			
"Down/Stay"	<input type="checkbox"/>	<input type="checkbox"/>			
"Out" for reward only	<input type="checkbox"/>	<input type="checkbox"/>			
QUALIFICATION DATA					
NOMENCLATURE		DATE		QUALIFICATION OR ELIMINATED	
Combat Tracker				Qualified	
DAYS IN TRAINING	DAYS NOT TRAINED	TOTAL DAYS IN TRAINING	DATE ENTERED TRAINING		
DISPOSITION					
Ship Combat Tracker					
TYPE NAME, GRADE, AND TITLE OF TRAINING SUPERVISOR			SIGNATURE		
TYPE NAME, GRADE, AND TITLE OF EVALUATOR			SIGNATURE		
TYPE NAME, GRADE, AND TITLE OF COMMANDER			SIGNATURE		
REMARKS					

LACKLAND AFB FORM 375, JUN 17 (EF-V1) PREVIOUS EDITION IS OBSOLETE

LAFB 375	Tracking Dog Qualification
<ul style="list-style-type: none"> <li>• Three-page document containing qualification information from the initial tracking dog training organization.</li> <li>• Establishes a performance baseline.</li> <li>• Completed by the 341 TRS, JBSA-Lackland.</li> </ul>	

SSD DETECTION QUALIFICATION					
TO 341 TRS/DOLM		FROM 341 TRS/DOOS			
NAME OF DOG	BRAND NUMBER	WHELP DATE	BREED	SEX	
SPARKY	Z123	1 October 2014	Lab	F	
NAME AND GRADE OF TRAINER		SIGNATURE			
Canine Handler, E-3, USMC					
NAME AND GRADE OF TRAINING SUPERVISOR		SIGNATURE			
Canine Trainer, E-6, USMC					
TRAINED SUBSTANCES					
AMMONIA DYNAMITE	<input type="checkbox"/>	TNT	<input checked="" type="checkbox"/>	SMOKELESS POWDER	<input checked="" type="checkbox"/>
DETONATION CORD	<input checked="" type="checkbox"/>	WATER GEL	<input type="checkbox"/>	SEMTEX	<input type="checkbox"/>
COMPOSITION 4	<input checked="" type="checkbox"/>	POTASSIUM CHLORATE	<input checked="" type="checkbox"/>	SODIUM CHLORATE	<input checked="" type="checkbox"/>
AMMONIUM NITRATE	<input checked="" type="checkbox"/>				
OTHER (SPECIFY): TIME FUSE (TF), EMULSION (EM), NETRO DYNAMITE (ND)					
VERIFICATION OFFICIALS					
INSTRUCTOR			SIGNATURE		
TASK	ODOR AMOUNT & TYPE	DATE	SEARCH TIME	AID HEIGHT	AID DEPTH
BUILDING EXTERIOR	1/2lb TNT, 10' TF, 1lb SP	3-Aug-18			
BUILDING INTERIOR	1lb AN, 1lb SC, 1lb PC	3-Aug-18			
VEHICLES OFF LEASH	5' TF, 1lb AN	3-Aug-18			
VEHICLES ON LEASH	1lb ND, 1 1/4LB C4	3-Aug-18			
ROADWAY #2 'BOX'	1LB TNT, 10' DC, 1LB SP	5-Aug-18			
ROADWAY #1 'VERGE'	1LB EM, 1LB SC, 1LB PC	5-Aug-18			
RUMMAGE	1LB SP, 5' DC, 1/2LB ND	6-Aug-18			
URGENT RECALL RUMMAGE	1 1/4LB C4, 1/2LB EM	6-Aug-18			
OPEN AREA	10' TF	6-Aug-18			
PERIMETER					
QUALIFICATION DATA					
NOMENCLATURE		DATE		QUALIFIED OR ELIMINATED	
SSD		6 August 2018		Qualified	
DAYS IN TRAINING	DAYS NOT TRAINED	TOTAL DAYS IN TRAINING			
20	8	28			
DATE ENTERED TRAINING	DETECTOR RESPONSE REWARD	DISPOSITION			
9 July 2018	Down/Tennis Ball	Ship SSD			
TYPE NAME, GRADE, AND TITLE OF EVALUATOR			SIGNATURE		
Evaluator, E-7, USAF, MWD Training Evaluator					
TYPE NAME, GRADE, AND TITLE OF COMMANDER			SIGNATURE		
USAF, Commander					

LACKLAND AFB FORM 375b MAY 05 (OPR: 341TRSDOOCB) PREVIOUS EDITION IS OBSOLETE

LAFB 375b	Specialized Search Dog (SSD) Detection Qualification
<ul style="list-style-type: none"> <li>• Three-page document containing qualification information from the initial search dog training organization.</li> <li>• Establishes a performance baseline for both the dog and the first assigned handler.</li> <li>• Completed by the 341 TRS, JBSA-Lackland.</li> <li>• Details about training in the TRAINING COMMENTS section on the last page.</li> </ul>	

SAMPLE

SAMPLE



341ST TRAINING SQUADRON  
375 ROUTING SLIP



\*\* Suspense date is 10 working days from evaluation completion\*\*

MWD Name	Date Evaluation Complete	375 Type
		SHIP

	Date Received	Comments	Date Completed/Forwarded	Signature
SSD Trainer				
SSD Course Chief				
OPS				
EVALS				
OPS				

**LAFB 375c Specialized Search Dog (SSD) Obedience/Control Qualification**

- Three-page document containing qualification information from the initial search dog training organization.
- Establishes a performance baseline for both the dog and the first assigned handler.
- Completed by the 341 TRS, JBASA-Lackland.
- Details about training in the TRAINING COMMENTS section on the last page.
- **NOTE:** E-Collar to be indicated in this section if approved training was conducted.

**SSD OBEDIENCE/CONTROL QUALIFICATION**

TO 341 TRS/DOLM		FROM 341 TRS/DOOS	
NAME OF DOG	BRAND NUMBER	WHELP DATE	BREED
SPARKY	Z123	1 January 2018	Lab
NAME AND GRADE OF TRAINER	SIGNATURE	SEX	
Canine Handler, E-3, USMC		F	
NAME AND GRADE OF TRAINING SUPERVISOR	SIGNATURE		
Canine Trainer, E-8, USMC			

OBEDIENCE AND DIRECTIONAL CONTROL							
COMMAND	PASS	FAIL	DIRECTIONAL	COMMAND	PASS	FAIL	
*HEEL*	<input checked="" type="checkbox"/>	<input type="checkbox"/>		*BACK*	<input checked="" type="checkbox"/>	<input type="checkbox"/>	
*HEEL* (MARCHING)	<input checked="" type="checkbox"/>	<input type="checkbox"/>		*LEFT*	<input checked="" type="checkbox"/>	<input type="checkbox"/>	
*HEEL* (JOGGING)	<input checked="" type="checkbox"/>	<input type="checkbox"/>		*RIGHT*	<input checked="" type="checkbox"/>	<input type="checkbox"/>	
*DOWN*	<input checked="" type="checkbox"/>	<input type="checkbox"/>		*HERE*	<input checked="" type="checkbox"/>	<input type="checkbox"/>	
*SIT* (30 METERS)	<input checked="" type="checkbox"/>	<input type="checkbox"/>		*HUNT IT UP*	<input checked="" type="checkbox"/>	<input type="checkbox"/>	
*COVER* (30 METERS)	<input checked="" type="checkbox"/>	<input type="checkbox"/>					
*INTERRUPTED RECALL*	<input checked="" type="checkbox"/>	<input type="checkbox"/>					
*HERE*	<input checked="" type="checkbox"/>	<input type="checkbox"/>					
SUNFIRE	<input checked="" type="checkbox"/>	<input type="checkbox"/>					

**VERIFICATION OFFICIALS**

INSTRUCTOR	SIGNATURE

**QUALIFICATION DATA**

NOMENCLATURE	DATE	QUALIFIED OR ELIMINATED
SSD		Qualified
DAYS IN TRAINING	DAYS NOT TRAINED	TOTAL DAYS IN TRAINING
DATE ENTERED TRAINING	OBEDIENCE REWARD	DISPOSITION
	Tennis Ball	Ship SSD
TYPE NAME, GRADE, AND TITLE OF EVALUATOR	SIGNATURE	
TYPE NAME, GRADE, AND TITLE OF COMMANDER	SIGNATURE	

**REMARKS**  
Sparky was initially trained utilizing "Force Fetch" commands differing from previous Specialized Search Dogs (SSD). The Down/Cover position has special significance: Down/Cover is the dog's final response position, and the dog may only leave the position to recall to the handler or when released to reward. It is not desirable for the dog to learn to move from Down/Cover to Sit position. This may destabilize the final response. Accordingly, and in coordination with 341<sup>st</sup> TRS Commander and Marine Corps Military Working Dog Program Managers, the Cover/Down-to-Sit exercise was omitted. (See N/A above).

QUESTION	YES	NO	QUESTION	YES	NO
1. IS THE DOG/HANDLER AGGRESSIVE?	<input type="checkbox"/>	<input checked="" type="checkbox"/>	4. DOES THE DOG HAVE A STAMINA PROBLEM?	<input type="checkbox"/>	<input checked="" type="checkbox"/>
2. IS THE DOG A HEAVY PANTER?	<input type="checkbox"/>	<input checked="" type="checkbox"/>	5. ARE THERE ANY KNOWN MEDICAL PROBLEMS TO PRECLUDE DETECTOR DOG WORK?	<input type="checkbox"/>	<input checked="" type="checkbox"/>
3. IS THE DOG BUILDING BHT?	<input type="checkbox"/>	<input checked="" type="checkbox"/>	6. IS THE DOG A DOG FIGHTER?	<input type="checkbox"/>	<input checked="" type="checkbox"/>

TRAINING COMMENTS (If answered "Yes", explain in this section)  
SD Sparky Z123

Main retrieval reward- Bumper

Stamina-

Free Search/Hunting Behavior-

E Collar type and pressure level-

E Collar Conditioning/Force Fetch-

Front Finish-

Directional Casting-

Recall/Return-

Emergency Recall-

Whistle commands-

Special habits and traits-

Other comments- If there are any questions, contact 341 TRS/DOQE at 341TRS.Evaluations@us.af.mil or (210) 671-8043 or DSN 473-8043.

SAMPLE  
LAST  
PAGE

<b>DD 1834</b>	<b>MWD Service Record</b>
<ul style="list-style-type: none"> <li>Two sided document to record key data associated with the MWD period of service.</li> <li>Initiated by the 341 TRS, JBSA-Lackland.</li> <li>MWD section updates following blocks as required with hand printed information [English text] in black or dark blue ink: <ul style="list-style-type: none"> <li>- New Course Info</li> <li>- Final Disposal Info</li> <li>- Handler Info</li> </ul> </li> </ul> <p><b>** List caretakers if assigned for <u>more than 30 days</u>.</b></p>	

MILITARY WORKING DOG SERVICE RECORD							
TATTOO NO.	CALL NAME	COLOR	HEIGHT	WEIGHT	DATE WHELPED	SEX	
DATE ACCEPTED	NATIONAL STOCK NUMBER <i>(Untrained)</i>						
RECORD OF FORMAL TRAINING							
COURSE NO.	DATE ENTERED	DATE CERTIFIED	NATIONAL STOCK NUMBER ASSIGNED	NOMENCLATURE			
REMARKS							
REWARD:							
FINAL RESPONSE:							
ODORS TRAINED:							
<table border="1" style="margin: auto;"> <tr> <td style="width: 100px; height: 20px; text-align: center;">Front</td> </tr> </table>							Front
Front							
WAS THE MWD ADOPTED BY ITS CURRENT OR ITS PREVIOUS HANDLER? <input type="checkbox"/> NO <input type="checkbox"/> YES <small>(IF YES, IDENTIFY NAME OF ADOPTER)</small>							
CURRENT/FORMER HANDLER NAME: _____							
FINAL DISPOSITION							
DATE	REASON	LAST UNIT OF ASSIGNMENT					

**DD FORM 1834, OCT 2017**   REPLACES AF FORM 323, FEB 69, WHICH IS OBSOLETE.

HANDLER	GRADE	HANDLER SIGNATURE	DATE ASSIGNED	UNIT OF ASSIGNMENT

**DD FORM 1834 Reverse, OCT 2017**

Reset
-------

Reverse
---------

<b>DD</b> <b>2875</b>	<b>System Authorization Access Request (SAAR)</b>
<ul style="list-style-type: none"> <li>• Three page documents which establish trustworthiness of individual required to have access to WDMS.</li> <li>• Entries made in the digital format and printed in hardcopy for signature and submission.</li> <li>• Completed by the requesting individual and supporting command per instructions on the last page.</li> <li>• MWD section identifies the type access rights individual will have in system [see table 8-1 for description of user rights and what rights can assigned by section billet].</li> <li>• Section III is completed by the requesting unit security officer.</li> <li>• <b>A National Agency Check w/ Local Credit Check (NACLC) is required for submission of this form.</b></li> <li>• A current security clearance is <b>not</b> required for submission of this form.</li> <li>• <b>Current form and submission instructions are available in the WDMS library folder "USMC Forms". Contact MWD PM for questions (see Appendix C).</b></li> </ul>	

1<sup>st</sup> Page

2<sup>nd</sup> Page

SYSTEM AUTHORIZATION ACCESS REQUEST (SAAR)			
<b>PRIVACY ACT STATEMENT</b>			
<small>AUTHORITY: Executive Order 10450, 9397, and Public Law 99-474, the Computer Fraud and Abuse Act.            PRINCIPAL PURPOSE: To record names, signatures, and other identifiers for the purpose of validating the trustworthiness of individuals requesting access to Department of Defense (DoD) systems and information. NOTE: Records may be maintained in both electronic and/or paper form.            ROUTINE USES: None.            DISCLOSURE: Disclosure of this information is voluntary; however, failure to provide the requested information may impede, delay or prevent further processing of this request.</small>			
TYPE OF REQUEST <input checked="" type="checkbox"/> INITIAL <input type="checkbox"/> MODIFICATION <input type="checkbox"/> DEACTIVATE <input type="checkbox"/> USER ID		DATE (YYYYMMDD)	
SYSTEM NAME (Platform or Applications) USMC Module of the Working Dog Management System (WDMS)		LOCATION (Physical Location of System) Joint Base San Antonio-Lackland	
<b>PART I (To be completed by Requestor)</b>			
1. NAME (Last, First, Middle Initial)		2. ORGANIZATION	
3. OFFICE SYMBOL/DEPARTMENT		4. PHONE (DSN or Commercial)	
5. OFFICIAL E-MAIL ADDRESS		6. JOB TITLE AND GRADE/RANK	
7. OFFICIAL MAILING ADDRESS		8. CITIZENSHIP <input checked="" type="checkbox"/> US <input type="checkbox"/> FN <input type="checkbox"/> OTHER	
		9. DESIGNATION OF PERSON <input checked="" type="checkbox"/> MILITARY <input type="checkbox"/> CIVILIAN <input type="checkbox"/> CONTRACTOR	
10. IA TRAINING AND AWARENESS CERTIFICATION REQUIREMENTS (Complete as required for user or functional level access.) <input type="checkbox"/> I have completed Annual Information Awareness Training.    DATE (YYYYMMDD)			
11. USER SIGNATURE		12. DATE (YYYYMMDD)	
<b>PART II - ENDORSEMENT OF ACCESS BY INFORMATION OWNER, USER SUPERVISOR OR GOVERNMENT SPONSOR (If individual is a contractor - provide company name, contract number, and date of contract expiration in Block 16.)</b>			
13. JUSTIFICATION FOR ACCESS Individual needs to access the Working Dog Management System to updated and review Military Working Dog (MWD) Training and Utilization at assigned kennel for USMC assets.			
14. TYPE OF ACCESS REQUIRED: <input checked="" type="checkbox"/> AUTHORIZED <input type="checkbox"/> PRIVILEGED			
15. USER REQUIRED ACCESS TO: <input type="checkbox"/> OTHER <input checked="" type="checkbox"/> UNCLASSIFIED <input type="checkbox"/> CLASSIFIED (Specify category)			
16. VERIFICATION OF NEED TO KNOW I certify that this user requires access as requested. <input type="checkbox"/>		16a. ACCESS EXPIRATION DATE (Contractors must specify Company Name, Contract Number, Expiration Date. Use Block 27 if needed.)	
17. SUPERVISOR'S NAME (Print Name)		18. SUPERVISOR'S SIGNATURE	19. DATE (YYYYMMDD)
20. SUPERVISOR'S ORGANIZATION/DEPARTMENT		20a. SUPERVISOR'S E-MAIL ADDRESS	20b. PHONE NUMBER
21. SIGNATURE OF INFORMATION OWNER/OPR		21a. PHONE NUMBER	21b. DATE (YYYYMMDD)
22. SIGNATURE OF IAO OR APPOINTEE		23. ORGANIZATION/DEPARTMENT	24. PHONE NUMBER
		24. PHONE NUMBER	25. DATE (YYYYMMDD)

25. NAME (Last, First, Middle Initial)			
27. OPTIONAL INFORMATION (Additional Information) Please indicate the access level required to the system:  Service: Marine  Access Level: Handler Trainer Kennel Master			
<b>PART III - SECURITY MANAGER VALIDATES THE BACKGROUND INVESTIGATION OR CLEARANCE INFORMATION</b>			
28. TYPE OF INVESTIGATION		28a. DATE OF INVESTIGATION (YYYYMMDD)	
28b. CLEARANCE LEVEL		28c. IT LEVEL DESIGNATION <input type="checkbox"/> LEVEL I <input type="checkbox"/> LEVEL II <input type="checkbox"/> LEVEL III	
29. VERIFIED BY (Print name)		30. SECURITY MANAGER TELEPHONE NUMBER	31. SECURITY MANAGER SIGNATURE
			32. DATE (YYYYMMDD)
<b>PART IV - COMPLETION BY AUTHORIZED STAFF PREPARING ACCOUNT INFORMATION</b>			
TITLE:	SYSTEM	ACCOUNT CODE	
	DOMAIN		
	SERVER		
	APPLICATION		
	DIRECTORIES		
	FILES		
	DATASETS		
DATE PROCESSED (YYYYMMDD)	PROCESSED BY (Print name and sign)		DATE (YYYYMMDD)
DATE REVALIDATED (YYYYMMDD)	REVALIDATED BY (Print name and sign)		DATE (YYYYMMDD)

<b>MC MWD-1</b>	<b>Detection Event Data Worksheet</b>
<ul style="list-style-type: none"> <li>Multi page document that provides a formatted worksheet to record, in the field, the task features and team results associated with any TVC detection event [drug/explosive].</li> <li>Supplement pages used as required [one team on first page; two teams on supplement].</li> <li>An Excel file available in the WDMS library for local production of hardcopy.</li> <li>No requirement to maintain this document after the team results are recorded in WDMS.</li> </ul>	

USMC MILITARY WORKING DOG PROGRAM Detection Event Data Sheet														
DATE		EVALUATOR			WEATHER			LOCATION						
SEARCH AREA		Aircraft Marine		Building Directions		Logage Open Area		Overpass/Bridge Runways		Theater Vehicles Warehouses		Comments		
TASK CONFIGURATION														
TASK NO.	Type Training Aid [see key]	Quantity	Height	Depth	Time Set	Location								
1														
2														
3														
4														
5														
6														
7														
8														
9														
10														
TEAM RESULTS														
MWD Name	Brand	Handler	Start Time	End Time	1ST Response Time	Event Type [TVC]	Trial Response by Task Number [* Positive Resp   (+) Assisted Positive Resp   - Miss   (-) Handler Error   A Agree]					False Responses	Fringe Responses	Training Rating [S/U]
							(1) (2) (3) (4) (5) (6) (7) (8) (9) (10)							
							(1) (2) (3) (4) (5) (6) (7) (8) (9) (10)							
							(1) (2) (3) (4) (5) (6) (7) (8) (9) (10)							
							(1) (2) (3) (4) (5) (6) (7) (8) (9) (10)							
							(1) (2) (3) (4) (5) (6) (7) (8) (9) (10)							
							(1) (2) (3) (4) (5) (6) (7) (8) (9) (10)							
							(1) (2) (3) (4) (5) (6) (7) (8) (9) (10)							
							(1) (2) (3) (4) (5) (6) (7) (8) (9) (10)							
							(1) (2) (3) (4) (5) (6) (7) (8) (9) (10)							
							(1) (2) (3) (4) (5) (6) (7) (8) (9) (10)							
<b>TRAINING AID KEY</b>		DC = Detonation Cord (5 FT STANDS)		AP = Smokeless Powder (1 LBS / CAN)		EM = Water Gel (.5 LBS / STICK)		No Aid		CO-Cocaine		MOM-MDMA		DATE RECORDED IN WDMS
AD = Ammonium Nitrate Dynamite (.5 LBS / STICK)		PC = Potassium Chlorate (1 LBS 2 OZ / BOTTLE)		TP = Time Fuse (9 FT STANDS)				Other		HA-Hashish		ME-Methamphetamine		
O4 = O-4 (.25 LBS / STICK)		BC = Redium Chlorate (1 LBS 2 OZ / BOTTLE)		TWP = TWP (.25 LBS / STICK)				Residual		ME-Heroin		MJ-Marijuana		

1<sup>st</sup> Page

Detection Event Data Sheet - Supplement FOR ENTRY OF TEAM RESULTS FOR EVENT ON SHEET 1																														
TEAM INFORMATION														TEAM INFORMATION																
TEAM NAME														TEAM NAME																
HANDLER														HANDLER																
TRAINING														TRAINING																
START TIME														START TIME																
END TIME														END TIME																
EVENT RATING														EVENT RATING																
TEAM RESULTS [SEE EVENT CONFIGURATION FOR EACH TASK ON SHEET 1]														TEAM RESULTS [SEE EVENT CONFIGURATION FOR EACH TASK ON SHEET 1]																
TASK NO.	1st	2nd	3rd	4th	5th	6th	7th	8th	9th	10th	Total	Total	False	False	1st	2nd	3rd	4th	5th	6th	7th	8th	9th	10th	Total	Total	False	False	Task	
											(U)	(U)	(N)	(N)	(N)															
1																														1
2																														2
3																														3
4																														4
5																														5
6																														6
7																														7
8																														8
9																														9
10																														10
11																														11
12																														12
Comments about team results:														Comments about team results:																
TOTALS														TOTALS																
OVERALL ACCURACY (N/A)														OVERALL ACCURACY (N/A)																
SA. TRAINER'S INITIALS:														SB. TRAINER'S INITIALS:																
SA. DATE RECORDED IN WDMS														SB. DATE RECORDED IN WDMS																

Supplement Page

**MC MWD-2 Tracking Event Data Worksheet**

- Single page document that provides a formatted worksheet to record, in the field, the task features and team results associated with any tracking event for any qualification activity [TV].
- An Excel file available in the WDMS library for local production of hardcopy.
- **No requirement to maintain this document after the team results are recorded in WDMS.**

UNITED STATES MARINE CORPS MILITARY WORKING DOG PROGRAM <b>Tracking Event Data Sheet</b>	
1. WORKING DOG SERVICE	2. EVENT TYPE
3. EVENT DATE	4. LOCATION
5. TRACK TYPE	6. TRACK TYPE
7. TEAM INFORMATION	8. TRACK TYPE
9. HANDLER	10. TRACK TYPE
11. WEATHER	12. TRACK TYPE
13. WIND SPEED	14. TRACK TYPE
15. WIND DIRECTION	16. TRACK TYPE
17. TEMPERATURE	18. TRACK TYPE
19. TRACK START	20. TRACK TYPE
21. STARTING POINT	22. TRACK TYPE
23. TRACK DATA	24. TRACK TYPE
25. DISTANCE	26. TRACK TYPE
27. ARTICLE FOUND	28. TRACK TYPE
29. SURFACES	30. TRACK TYPE
31. OBSTACLES	32. TRACK TYPE
33. DELIBERATE MOVEMENTS	34. TRACK TYPE
35. QUARRY FOUND	36. TRACK TYPE
37. ALERT DESCRIPTION	38. TRACK TYPE
39. 11. COMMENTS	40. TRACK TYPE
41. EVALUATOR	42. TRACK TYPE
43. DATE	44. TRACK TYPE



<b>MC MWD-3</b>	<b>Food, Weight, and Stool Report</b>
-----------------	---------------------------------------

- Single page document that provides a formatted worksheet to record key daily MWD care tasks and physical condition observations.
- An Excel file available in the WDMS library for local production of hardcopy.
- This document is maintained per instructions in Chapter 10.

United States Marine Corps Military Working Dog (MWD)						REPORT PERIOD	
<b>Food, Weight, and Stool Chart</b>						MONTH: _____	
						YEAR: _____	
<b>MWD Section / Location:</b>							
1. MWD NAME		2. BRAND	3. TYPE		4. BREED	5. AGE (YEARS)	
6. IDEAL WORKING WEIGHT RANGE [LBS] (Note 1) Min: _____ Max: _____				7. STANDARD DIET (Note 1): a. (TYPE)		b. (AMOUNT/FEEDING)	
8. HANDLER / CARETAKER [Rank, First Name, Last Name]							
<b>9. DAILY LOG</b>							
DATE	DIET (Note 2)	TIME FED	STOOL (Note 3)	WEIGHT [LBS] (Note 4)	MEDICATION (Note 5)	CARETAKER INITIALS	REMARKS
1							
2							
3							
4							
5							
6							
7							
8							
9							
10							
11							
12							
13							
14							
15							
16							
17							
18							
19							
20							
21							
22							
23							
24							
25							
26							
27							
28							
29							
30							
31							
<b>10. NOTES</b>							
1. This information is provided by the Veterinary Control Officer.							
2. Diet entries: [STD] standard per #7, [SPECIAL] special diet type/amount (show in remarks) Include observation on how much the MWD ate: ([A] All, [S] Some, [N] None) Examples: STD/A - MWD ate all of standard feeding; SPECIAL/S - MWD ate some of special diet							
3. Stool entries: [X] yes, [N] no, add remarks for unusual color or loose stool							
4. Weigh dog at least weekly.							
5. Administer HEARTGUARD monthly.							
<b>11. MEDICATIONS</b>							
TYPE OF MEDICATION	DOSAGE		START DATE		STOP DATE		
The completed original of this document is to be filed IAW the USMC MWD MANUAL.							
Form MC MWD-3 MWD Food, Weight, & Stool Chart (DEC 2012)							

<b>MC MWD-4</b>	<b>MWD Section Command Chronology Report Part 1 of 2</b>
<ul style="list-style-type: none"> <li>• Multi-tab excel report generated from WDMS under KM/Reports tab.</li> <li>• One format for all MWD sections with utilization activity reported in detail within the four major support efforts: <ul style="list-style-type: none"> <li>▶ Base</li> <li>▶ Off-Base</li> <li>▶ HMX-1 Missions</li> <li>▶ Deployment</li> </ul> </li> <li>• Each report available selected time periods back to 2005.</li> <li>• Total activity hours should match those in the Statistics Report [KM Report] for same period.</li> </ul>	

UNITED STATES MARINE CORPS							1. REPORT DATE	
MILITARY WORKING DOG (MWD) SECTION COMMAND CHRONOLOGY REPORT							03/30/2012	
ACTIVITY OVERVIEW								
2. SELECTED REPORTING LOCATION:		3. REPORTING PERIOD START:			4. REPORTING PERIOD END:			
Quantico MCB YA		03/30/2011			03/30/2012			
a. Type Activity	b. Occurrences	c. Teams Assigned	d. Items Involved	e. Patrol / Dog Team Time (Hr:Min)	f. Patrol / Explosive Team Time (Hr:Min)	g. Special Search Team Time (Hr:Min)	h. Tracking Team Time (Hr:Min)	i. Total Team Time (Hr:Min)
<b>5. MWD TEAM UTILIZATION IN SUPPORT OF PARENT BASE OPERATIONS</b>								
<b>Vehicle Search</b>								
Commanding Officer Vehicle Inspection (COVI)			10	0:48	0:42			1:30
Command Authorized Request (CAR)			12	1:18	0:22			1:40
Random Anti-Terrorism Measures (RAM)			1		0:04			0:04
Other			89	13:41	10:47			24:28
<b>Total</b>			<b>112</b>	<b>15:47</b>	<b>11:55</b>	<b>0:00</b>	<b>0:00</b>	<b>27:42</b>
<b>Barracks Search</b>								
Command Authorized Request (CAR)			4	0:25	1:18			1:43
Random Anti-Terrorism Measures (RAM)								0:00
Other			1	0:03				0:03
<b>Total</b>			<b>5</b>	<b>0:28</b>	<b>1:18</b>	<b>0:00</b>		<b>1:46</b>
<b>VIP Sweeps</b>								
			18		0:19			0:19
<b>Mission Essential Vital Area (MEVA)</b>								
								0:00
<b>Searches Not Included Above</b>								
Aircraft			1		0:01			0:01
Baggage			1	0:03				0:03
Brig			1	0:01				0:01
Building			17	0:02	0:38			0:40
Cargo								0:00
Hangar								0:00
Open Area			12		0:12			0:12
Other				0:20				0:20

Tab 1 - Overview

Activity details reported by MWD capability in the following sections:

- \* SUPPORT OF PARENT BASE OPERATION
- \* SUPPORT OF OFF-BASE AGENCIES
- \* SUPPORT OF OFF-BASE HMX-1 ASSIGNMENTS
- \* SUPPORT OF DEPLOYMENT / COMBAT OPERATIONS
- \* MWD TEAM QUALIFICATION
- \* GRAND TOTAL MWD SECTION ACTIVITY
- \* MWD STATUS

**MC MWD-4** **MWD Section Command Chronology Report**  
**Part 2 of 2**

UNITED STATES MARINE CORPS									1. REPORT DATE
MILITARY WORKING DOG (MWD) SECTION COMMAND CHRONOLOGY REPORT									03/30/2012
UTILIZATION SEARCH DETAILS									
2. SELECTED REPORTING LOCATION:	3. REPORTING PERIOD START:								4. REPORTING PERIOD END:
Quantico MCB VA	03/30/2011								03/30/2012
<b>5. DRUG (BY TYPE)</b>									
a. Substance	b. Date [dd/mm/year]	c. Support Category	d. Team Name [MWD/Handler LN]	e. MWD Type	f. Residual	g. Qty [Kg]	h. Field Test Result	i. Lab Test Result	j. Case No.
Marijuana	02/24/2012	Base Ops - Other	Tyson/Spear	P/DDD	Y				1230060001073
Marijuana	12/03/2011	Base Ops - Other	Benik/Olszak	DDD			Pending	Pending	230V-05333-TNMA
Marijuana	07/03/2011	Base Ops - Other	Tyson/Finley	P/DDD			Positive	Positive	113006003473
Marijuana	04/21/2011	Base Ops - Other	Andy/Caram	P/DDD		0.001			
Marijuana	04/16/2011	Base Ops - Other	Andy/Caram	P/DDD		0.005	Positive	Positive	
Marijuana	04/06/2011	Base Ops - Other	Tyson/Finley	P/DDD			Positive	Positive	113006001826
Marijuana	04/06/2011	Base Ops - Other	Tyson/Finley	P/DDD					113006001823
<b>Total</b>						0.006			
<b>6. EXPLOSIVE (BY TYPE)</b>									
a. Substance	b. Date [dd/mm/year]	c. Support Category	d. Team Name [MWD/Handler LN]	e. MWD Type	f. Residual	g. Qty [Lbs]	h. Field Test Result	i. Lab Test Result	j. Case No.
Unknown	05/03/2011	Base Ops - Other	Fannin/Macy	P/EDD					N/A
<b>Total</b>									
<b>7. PERSON (BY TECHNIQUE)</b>									
a. Search Technique	b. Date [dd/mm/year]	c. Support Category	d. Team Name [MWD/Handler LN]	e. MWD Type	f. # Persons Found				
Intruder Detection	12/19/2011		Rony/Davis	P/EDD	1				
Intruder Detection	12/05/2011		Miky/Davis	P/EDD	1				
Intruder Detection	11/21/2011		Miky/Davis	P/EDD	2				

**Tab 3 -  
Utilization Search  
Details  
(Pages - as req'd)  
Reported by:  
\* DRUG  
\* EXPLOSIVE  
\* PERSON**

UNITED STATES MARINE CORPS	
MILITARY WORKING DOG (MWD) SECTION COMMAND CHRONOLOGY REPORT	
Significant Activity Synopsis	
2. SELECTED REPORTING LOCATION:	
3. REPORTING PERIOD START:	
4. REPORTING PERIOD END:	
Date	Significant Daily Events [In Date Sequence]

**Tab 2 -  
Significant  
Activity Synopsis  
(Pages - as req'd)**

<b>MC MWD-5</b>	<b>Canine Explosive Authorization Package (CEAP) Data Card</b>
<ul style="list-style-type: none"> <li>• Single page document that provides a formatted worksheet to record the contents of a CEAP storage container [either CLEAN or DIRTY explosive components] during the FY.</li> <li>• Multiple card copies may be required depending on the number of transactions experienced.</li> <li>• Completion instructions are provided at the bottom of the form.</li> <li>• An Excel file available in the WDMS library for local production of hardcopy in desired color or paper weight.</li> <li>• <b>No requirement to maintain this document after the receipt of the annual CEAP replacement.</b></li> </ul>	

UNITED STATES MARINE CORPS MILITARY WORKING DOG (MWD) PROGRAM CANINE EXPLOSIVE AUTHORIZATION PACKAGE (CEAP) DATA CARD																				
FY <u>16</u> CARD # <u>1</u> OF <u>1</u>																				
CEAP STORAGE BOX: <u>Camp Lejeune Base MWD</u> <span style="border: 1px solid black; border-radius: 5px; padding: 2px;">CLEAN</span> DIRTY]																				
Symbol	Description	DODIC	NSN (Record Issued Number)	Size	Card Carry Over Balance	Transaction #1			Transaction #2			Transaction #3			Transaction #4			Transaction #5		
						Date: 5 Oct 16			Date: 10 Oct 16			Date: 5 Nov 16			Date: 3 Jan 17			Date: 2 Mar 17		
						Entry By: J.O Marine			Entry By: J.O Marine			Entry By: T.J. Smith			Entry By: J.O Marine			Entry By: O.Y. Jones		
		In	Out	Bal			In	Out	Bal			In	Out	Bal			In	Out	Bal	
AD	Ammonium Nitrate Dynamite, AN 40%	M585	1375-00-096-3095	1/2 Lbs Stick		18		18		18		2	16		9	7		1	6	
C4	C-4	M023	1375-01-154-4038	1-1/4 Lbs Block		5		5	5	10		1	9		9				9	
DC	Detonating Cord, PETN	M456	1375-00-025-3281	10 Ft Length		6		6		6		2	4		4				4	
EM	Emulsion	DWDR	1375-01-581-0468	1/2 Lbs Stick		18		18		18		3	15		15				15	
SP	Smokeless Powder	MY57	1376-01-597-1992	1 Lbs Can					6	6		1	5		5		1	4		
TF	Time Fuse, Blasting	M670	1375-00-028-5150	10 Ft Length		6		6		6		1	5		5				5	
TNT	TNT, Trinitrotoluene	M030	1375-23-112-4169	1/4 Lbs Block		40		40		40		5	35		35		5	30		
<b>EXAMPLE - FIRST CARD FOR FY</b>																				
<b>INSTRUCTIONS:</b> 1. Record transactions that change box quantity on <u>form DD1348</u> or <u>is transfer from CLEAN to DIRTY box</u> (No entry for temporary issue for training use). 2. All transactions must be supported by entry in the Daily Issue/Return Log. 3. Varyify all box contents for each transaction and record all component balances even if there is no in/out quantity. 4. Report discrepancies to the ASP and KM. 5. Use as many cards as required for Fiscal Year (FY) and maintain in the folder on the outside box lid. 6. Carry transaction #5 balance to next card as carry over balance. 7. Discard previous FY cards after new CEAP rotation and start new FY card series <u>[cross out card carry over column on card #1]</u> .																				

Form MC MWD-5 CEAP Data Card [DEC 2012]

24 FEB 2020

NAVMC 11818-1	MWD Activity Report
<ul style="list-style-type: none"> <li>• Multi tab Excel worksheet report <u>generated in WDMS</u> using MWD team activity recorded during the month requested.</li> <li>• It provides a method to record each positive response and document the results of field and lab tests for all substances seized as a result of the MWDs response.</li> <li>• Initiated by the MWD handler at the end of each month using the request feature under "Handler / Reports" tab.</li> <li>• The signing kennel master and trainer are specified at the time of report request so the names will appear in the appropriate report blocks.</li> <li>• Only those report tabs required for the MWD capability on file will be shown in the report generated per table E-2.</li> <li>• Most report fields are self-explanatory and already defined within WDMS; consequently, only key review comments are noted on the sample reports.</li> </ul>	
<p><b>NOTES:</b></p>	
<p>1. <u>Only Tab 1 of NAVMC 11818-1 is required</u> to be maintained in the MWD service record [Active/Archive] unless the KM decides other tab(s) are deemed to be significant for future reference (i.e., major finds, pending legal action).</p>	
<p>2. <b>If access to WDMS is not available</b>, use of blank worksheet files is authorized until the system is available.</p>	

Table E-2.--MWD Activity Report Tabs		
MWD Capability	NAVMC 11818-1	Page Ref
All MWD	Tab 1 - MWD Activity Summary	E-17
	Tab 2 - Basic MWD Skills	E-19
	Tab 7 - Daily Synopsis	E-31
Patrol (P)	Tab 3 - Patrol Skills	E-20
Drug Detection (DDD)	Tab 4A - Detection Utilization Search Areas	E-21
	Tab 4B - Detection Utilization Search Data	E-22
Explosive Detection (EDD)(SSD)	Tab 5A - Detection Qualification Summary	E-23
	Tab 5B - Detection Qualification Search Areas	E-25
	Tab 5C - Detection Qualification Data	E-27
Tracking (CTD)	Tab 6A - Combat Tracker Summary	E-29
	Tab 6B - Combat Tracker Data	E-30

NAVMC 11818-1 MWD Activity Report Tab 1 - MWD Activity

UNITED STATES MARINE CORPS MILITARY WORKING DOG ACTIVITY REPORT Activity Summary																																						
2. NAME OF DOG		3. BREED		4. AGE		5. TYPE OF DOG		6. ORGANIZATION AND LOCATION							1. MONTH AND YEAR																							
7. INTRAINED/UTILIZED (See Legend)				8. See Tabs for Details		9. Report Tabs		DAY OF MONTH							TOTALS (Hr:Min)																							
SECTION I - BASIC MWD SKILLS				TAB 2		X		1	2	3	4	5	6	7	8	9	10	11	12	13	14	15	16	17	18	19	20	21	22	23	24	25	26	27	28	29	30	31
A. UTILIZATION				TIME(H:Min)																																		
B. QUALIFICATION (T+V)				TIME(H:Min)																																		
SECTION II - PATROL				TAB 3		X																																
A. UTILIZATION				TIME(H:Min)																																		
B. QUALIFICATION (T+V)				TIME(H:Min)																																		
SECTION III - DETECTION				TAB 4 (A-B)		X																																
A. UTILIZATION				TIME(H:Min)																																		
B. QUALIFICATION (T+V+C)				TIME(H:Min)																																		
SECTION IV - TRACKING				TAB 5 (A-C)		X																																
A. UTILIZATION				TIME(H:Min)																																		
B. QUALIFICATION (T+V)				TIME(H:Min)																																		
SECTION V - TOTALS				TAB 6 (A-B)																																		
A. UTILIZATION				TIME(H:Min)																																		
B. QUALIFICATION (T+V+C)				TIME(H:Min)																																		
C. TOTAL MWD ACTIVITY				TIME(H:Min)																																		
SECTION VI - SYNOPSIS OF DAILY EVENTS				TAB 7		X																																

LEGEND: C=Certification, CT=Caretaker Only, IT=MWD in Transit, LV=Leave, MS=MWD Sick, MT=MWD TAD, OC=On Call, OD=Off Duty, OT=Other, P=Primary Handler, RG=Range, T=Training, TD=TAD, V=Validation  
 9. Reviewer's Remarks: (Handwritten for the MWD Service Record folder report - not recorded in WDMIS)

**6**

# EXAMPLE -- PEDD

**10**

NOTE: Refer to the MWD Service Record folder for the current MWD Team qualification report(s).

10. HANDLER(S) ASSIGNED DURING MONTH		11. SIGNATURE OF HANDLER ASSIGNED AT MONTH END (SIGNATURE & RANK) / DATE	
HANDLER NAME (Last, First, Middle Initial)	RANK	TEAM ID	TEAM END DATE
14. KENNEL MASTER (Month End) (Last, First, Middle Name, Rank)		12. TRAINER (Month End) (Last, First, Middle Name, Rank)	
15. KENNEL MASTERS SIGNATURE (SIGNATURE & RANK) / DATE		13. TRAINER'S SIGNATURE (SIGNATURE & RANK) / DATE	

NAVMC 11818-1 MWD Team Activity Report, TAB 1 - MWD Activity Summary [WDMIS Generated] (JAN 2014)

See next page for comments on highlighted blocks.

24 FEB 2020

NAVMC 11818-1	MWD Activity Report	Tab 1 - MWD Activity
---------------	---------------------	----------------------

<p>1. The MWD Activity Report is generated once per month for each MWD regardless of the number of handler or caretaker assignments during the month.</p>
<p>2. Parent organization/location will printed in block 6 as recorded in WDMS. Additional information can be included in remarks (block 9) as required to clarify actual assignment location.</p>
<p>3. Each day of the month should be accounted for by either [at a minimum] an entry in Basic Skills or an entry in "Untrained / Unutilized". Since training detection events can be recorded separately form team data, reviewers must ensure that entries in Sect III,B have an associated entry in Sect I,B.</p>
<p>4. WDMS will only allow activity entry and generate Report Tabs for the assigned MWD type on file.</p>
<p>5. Total MWD Activity (Sect V,C.) must not exceed 24 hours in a single day. WDMS will highlight such an overage during the recording process, but not prevent the entry due to the multiple activities involved.</p>
<p>6. The kennel master has the opportunity to enter monthly hand written comments for the Record concerning any issues or observations concerning MWD condition or training trends.  <b>NOTE:</b> Any remarks concerning deficiencies or health problems should include a reference to an supporting memorandum for the record or veterinarian report which should be attached as the last page of the activity report and maintained in the MWD Service Record folder.</p>
<p>7. Handlers and caretakers assigned during the month will be listed in chronological order.</p>
<p>8. The kennel master, or designee, at the end of the month signs only the first tab of the report to authenticate the accuracy of the document to the best of his/her ability.</p>
<p>9. The assigned section trainer at the end of the month signs the first tab and initials all others to authenticate that the document was thoroughly reviewed and accurate to the best of his/her ability.</p>
<p>10. The handler / caretaker assigned at end of the month shall generate the monthly activity report and sign the report as witness to the authenticity of the document.</p>

NAVMC 11818-1 MWD Activity Report Tab 2 - Basic Skills

UNITED STATES MARINE CORPS										MONTH AND YEAR																								
MILITARY WORKING DOG ACTIVITY REPORT																																		
Basic MWD Skills																																		
2. NAME OF DOG	3. BREED	4. AGE (YEARS)	5. MWD TYPE	6. ORGANIZATION AND LOCATION																														
				1	2	3	4	5	6	7	8	9	10	11	12	13	14	15	16	17	18	19	20	21	22	23	24	25	26	27	28	29	30	31
7. UNTRAINED/UTILIZED (See Legend)				8. DAY OF MONTH																														
SECTION I - TRAINING (T)																																		
A. OBEDIENCE (ON LEASH) RATINGS																																		
(1) Heeling																																		
(2) Down from Heel																																		
(3) Sit from Down																																		
(4) Stay																																		
(5) Down at End of Leash																																		
(6) Sit at End of Leash																																		
(7) Recall to Heel																																		
B. OBEDIENCE (OFF LEASH) RATING																																		
C. OBSTACLE COURSE RATING																																		
D. GUNFIRE RATING																																		
- HANDLER (Rounds)																																		
- OTHER PERSONNEL (Rounds)																																		
E. PHYSICAL CONDITIONING RATING																																		
- DISTANCE (Miles)																																		
F. DEMONSTRATION (Number Conducted)																																		
G. MWD IN TRANSIT - TIME (Hr:Min)																																		
TOTAL TRAINING (T) TIME (Hr:Min)																																		
SECTION II - UTILIZATION (UTIL)																																		
H. VEHICLE PATROL - LOCATION																																		
I. WALKING PATROL - LOCATION																																		
J. STATIC POST - LOCATION																																		
SUPPORT CATEGORY (see Tab 4B or 6B)																																		
TOTAL UTILIZATION (UTIL) TIME (Hr:Min)																																		
SECTION III - VALIDATION (V)																																		
TOTAL VALIDATION (V) TIME (Hr:Min)																																		
SECTION IV - OTHER																																		
K. INDIFFERENCE RATINGS																																		
(1) ANIMAL																																		
(2) FOOD																																		
(3) PEDESTRIAN																																		
L. E-COLLAR USED																																		
TOTAL ACTIVITY (T+UTIL+V) TIME (Hr:Min)																																		
LEGEND: C=Continent, CO=Combat, CT=Caretaker Only, EG=ECR/Gate, FL=Flight Line, HO=Housing, IT=MWD in Transit, LO=PROP, LV=Leave, MS=MWD/SEK, MT=MWD/TAD, OC=On Call, OD=Off Duty, OT=Other, PE=Penetration, RB=Range, S=Satisfactory, T=Training, TD=TAD, U=Unsatisfactory, V=Validation																																		
S. TRAINER'S INITIALS:																																		
NOTE: Refer to the MWD Service Record folder for the current MWD Team Basic MWD Skills Validation Report.																																		
10. REPORT DATE																																		
NAVMC 11818-1 MWD Team Activity Report, TAB 2 - Basic Skills [WDMIS Generated] (JAN 2014)																																		

11. Only training (T) and utilization (UTIL) activity/ratings are recorded in Sections I and II, although the time recorded for validation (V) is included in Section III on the associated date. Validation results are recorded in the separate Basic Skills Validation Report [NAVMC 11818-19]. To find missing record dates, the reviewer should check each calendar date for either an entry in Block 7 or Total Activity.



**NAVMC 11818-1 MWD Activity Report Tab 3 - Patrol Skills**

<b>UNITED STATES MARINE CORPS</b>												1 MONTH AND YEAR	
<b>MILITARY WORKING DOG ACTIVITY REPORT</b>													
<b>Patrol Skills</b>													
2. NAME OF DOG		3. BRAND		4. AGE IN YEARS		5. TYPE OF DOG		6. ORGANIZATION AND LOCATION					
7. UNTRAINED/UTILIZED (See Legend)													
<b>SECTION I - TRAINING (T)</b>													
A. CONTROLLED AGGRESSION - TIME (Hr:Min)													
(1) FIELD INTERVIEW RATING													
(2) PURSUIT & ATTACK RATING													
(3) STAND OFF RATING													
(4) SEARCH & ESCORT RATING													
(5) SEARCH & RE-ATTACK RATING													
B. INTRUDER DETECTION - TIME (Hr:Min)													
(1) BUILDING SEARCH RATING													
(2) SIGHT SCOUT RATING													
Distance (Meters)													
(3) SCENT SCOUT RATING													
Distance (Meters)													
(4) SOUND SCOUT RATING													
Distance (Meters)													
<b>TOTAL TRAINING (T) TIME (Hr:Min)</b>												0 0	
<b>SECTION II - UTILIZATION (UTIL)</b>													
A. CONTROLLED AGGRESSION - TIME (Hr:Min)													
(1) FIELD INTERVIEW													
(2) PURSUIT & ATTACK													
(3) STAND OFF													
(4) SEARCH & ESCORT													
(5) SEARCH & RE-ATTACK													
B. INTRUDER DETECTION - TIME (Hr:Min)													
(1) BUILDING SEARCH													
(2) SIGHT SCOUT													
(3) SCENT SCOUT													
(4) SOUND SCOUT													
TOTAL PERSONS FOUND												0	
C. SECURITY ESCORT - TIME (Hr:Min)													
SUPPORT CATEGORY (see legend on Tab 4B)													
<b>TOTAL UTILIZATION (UTIL) TIME (Hr:Min)</b>												0 0	
<b>SECTION III - VALIDATION (V)</b>													
<b>TOTAL VALIDATION (V) TIME (Hr:Min)</b>													
<b>TOTAL ACTIVITY (T+UTIL+V) TIME (Hr:Min)</b>													
<b>LEGEND:</b> CT=Caretaker Only, IT=MWD in Transit, LV=Leave, MS=MWD Sick, MT=MWD TAD, OC=On Call, OD=Off Duty, OT=Other, RC=Range, S=Satisfactory, T=Training, TD=TAD, U=Unsatisfactory, V=Validation, X=Activity													
8. TRAINER'S INITIALS												9. REPORT DATE	
<b>NAVMC 11818-1 MWD Team Activity Report, TAB 3 - Patrol Skills [WDMS Generated] (JAN 2014)</b>													

NOTE: Refer to the MWD Service Record folder for the current MWD Team Patrol Skills Validation Report.

**12.** Only training (T) and utilization (UTIL) activity/ratings are recorded in Sections I and II, although the time recorded for validation (V) is included in Sect III on the associated date. Validation results are recorded in the separate Patrol Validation Report [NAVMC 11818-20].



<b>NAVMC 11818-1</b>	<b>MWD Activity Report</b>	<b>Tab 4B - Detection Utilization Search Data</b>
----------------------	----------------------------	---

<b>UNITED STATES MARINE CORPS</b>																
<b>MILITARY WORKING DOG ACTIVITY REPORT</b>																
<b>Detection Utilization Search Data</b>																
1. Month and Year		2. NAME OF DOG			3. BRAND		4. AGE (YEARS)		5. MWD TYPE							
									6. ORGANIZATION AND LOCATION							
									<b>15</b>							
<b>UTILIZATION SEARCH</b>																
SEARCH NO.	DATE	SPT CAT	SEARCH TIME (Hr:Min)	AREA	RATING	AREA DESCRIPTION	QTY SEARCH	REINF AID	+ RESP NO.	SUBST/ QTY ITEM	LOCATION	TIME	FIELD TEST RESULT	LAB TEST DATE	LAB TEST RESULTS	CASE NUMBER
1																
2																
<b>LEGEND:</b> AC = Aircraft, BA = Barracks, B CA = Base Ops-CAR, BCV = Base Ops-COMV, BG = Base Ops-MEA, BO = Base Ops-Other, BOP = Base Ops-Patrol, BR = Brig, BRM = Base Ops-RAM, BVS = Base Ops-VP, BU = Building, CA = City/Agency, CBP = Customs/Border Protection, CR = Cargo, CS = County/Agency, DCO = Deployment/Combat Ops, DEA = Drug Enforcement Agency, DOS = Dept of State, DHS = Dept of Homeland Sec, HR = Hangar, OA = Open Area, OBH = Off Base-HM, LOBO = Off Base-Other, OT = Other, OV = Overseas/Bridge, QT = Quarters, PO = Post Office, RD = Roadways, S = Satisfactory, SA = State Agency Spt, SL = School, TH = Theater, TU = Tunnel/Bunker, U = Unsatisfactory, UMS = US Maritime Svc, TSA = Trans Sec Agency, USS = Secret Svc, VE = Vehicles, WC = Watercraft, WH = Warehouse																
<b>SUBSTANCE / ITEM:</b> See ODORS / AID listing on TAB 5A																
COMMENTS																
<b>16</b>																
NAVMC 11818-1 MWD Team Activity Report, TAB 4B - Detection Utilization Search Data [WDMS Generated] (JAN 2014)																

**14.** The "Search No." is the system assigned sequential number for utilization searches recorded during the month. This number is only seen on this report.

**15.** The "+ Resp No." is the system assigned sequential number for positive responses recorded for a search. A search could result in multiple positive responses. This number is only seen on this report.

**16.** Comments recorded by the handler about the search are reported in the bottom section with reference to the assigned search number used in the top section. Residual odor responses should not be documented on this tab.



24 FEB 2020

NAVMC 11818-1	MWD Activity Report	Tab 5A - Detection Qualification Summary
---------------	---------------------	--

<p><b>17.</b> "Training Accuracy" (block 9) is the computation of the overall MWD detection performance based on training events recorded for the month. To establish the true relevance of a monthly performance, these results must be compared against the past monthly results [minimum previous three months] to determine if a performance trend exists. Consistent low results or a consistent downward trend on any aid should be evaluated by the kennel master and commented about on the first page of this report.</p>	<p><b>18.</b> "OTHER" training aid does not include "Blank/No-Aid" entries. Activity for Blank/No-Aid events is not recorded on this tab [see Tabs 5B and 5C].</p>	<p><b>19.</b> Validation and certification detection results are presented in summary of trials and responses on the date recorded for reference purposes only since these qualification processes involve several events that may overlap two months. The final result of these qualifications is recorded in the detection validation and certification reports.</p>
--	--	--

<b>NAVMC 11818-1</b>	<b>MWD Activity Report</b>	<b>Tab 5B - Detection Qualification Search Areas</b>
----------------------	----------------------------	--

UNITED STATES MARINE CORPS MILITARY WORKING DOG ACTIVITY REPORT Detection Qualification Search Areas		1 Month and Year																																	
		20	21																																
2. NAME OF DOG	3. BRAND	4. AGE IN YEARS	5. TYPE OF DETECTOR DOG	6. ORGANIZATION AND LOCATION																															
		7. DAY OF MONTH							8. TOTAL FOR MONTH																										
		1	2	3	4	5	6	7	8	9	10	11	12	13	14	15	16	17	18	19	20	21	22	23	24	25	26	27	28	29	30	31	TRIALS	POSITIVE RESPONSES (HR:MM)	TIME (HR:MM)
9. UNTRAINED/ UNUTILIZED (See Legend)																																	0	0	0:00
10. TRAINING AREA																																	0	0	0:00
AIRCRAFT																																	0	0	0:00
BAGGAGE																																	0	0	0:00
BARRACKS																																	0	0	0:00
BUILDINGS																																	0	0	0:00
OPEN AREAS																																	0	0	0:00
OTHER																																	0	0	0:00
ROADWAYS/ OVERPASSSES																																	0	0	0:00
TUNNELS / BUNKERS																																	0	0	0:00
VEHICLES																																	0	0	0:00
WAREHOUSES																																	0	0	0:00
11. TOTAL (T + V + C)																																	0	0	0:00
12. Validation (V) + Certification (C)																																	0	0	0:00
13. FALSE RESPONSES (T + V + C)																																	0	0	0:00
14. FRINGE RESPONSES (T + V + C)																																	0	0	0:00

NOTE: Refer to the MWD Service Record folder for the current MWD Team Detection Validation Report.

17. REPORT DATE

NAVMC 11818-1 MWD Team Activity Report, TAB 5B - Detection Qual Search Areas [WDMS Generated] [JAN 2014]

**See next page for comments on highlighted blocks.**

24 FEB 2020

NAVMC 11818-1	MWD Activity Report	Tab 5B - Detection Qualification Search Areas
---------------	---------------------	---

**20.** All qualification search area data is reported in this tab by the type area. A low number of trials could indicate that additional training focus is required in search type. A relatively low positive response in relation to the number of trials could be an indicator of a detection deficiency [MWD or team related] in a particular search type.

**21.** The number of false and fringe responses are an important indicator of MWD performance especially if there is a trend of increasing occurrence over the past three months. Reviewers should monitor these numbers and comment any unfavorable trends in the remarks field on the first page.

**NOTE:** BLANK/NO-AID event data will appear on this tab only as total time on the event date within the training area type. Also, FALSE responses will be reported in block 13.

NAVMC 11818-1	MWD Activity Report	Tab 5C - Detection Qualification Data
---------------	------------------------	--

UNITED STATES MARINE CORPS MILITARY WORKING DOG ACTIVITY REPORT Detection Qualification Data															
2. NAME OF DOG			3. BRAND				4. AGE (YEARS)		5. MWD TYPE		6. ORGANIZATION AND LOCATION			1. Month and Year	
22	23	25	26	24	24	24	24	24	24	24	24	24	24	24	
	EVENT NO.	EVENT DATE	QUAL TYPE	EVENT RATING	AREA	NIGHT	EVALUATOR	LOCATION	WEATHER	EVENT COMMENTS	START TIME	STOP TIME	TOTAL TIME	FALSE RESPONSES	FRINGE RESPONSES
		1st TRIAL TIME	AID		BURIED	HEIGHT	DEPTH	QUANTITY	TIME SET	AID LOCATION	TRIAL RESPONSES				
LEGEND: S=Satisfactory, U=Unsatisfactory AID=See Tab 5A for ODOR/AID listing.															
RESPONSE LEGEND:   + =Positive Response   (+) =Assisted Positive Response   - =Miss   (-) =Handler Error   A =Aggress															
EVENT NO. 1															
COMMENTS															
NAVMC 11818-1 MWD Team Activity Report, TAB 5C - Detection Qualification Data [WDMS Generated] (JAN 2014)															

See next page for comments on highlighted blocks.



NAVMC 11818-1	MWD Activity Report	Tab 5C - Detection Qualification Data
---------------	---------------------	---------------------------------------

<p><b>22.</b> The "Event No." is the system assigned sequential number for all qualification events recorded during the month. This number is only seen on this report.</p>
<p><b>23.</b> The task number is the sequential number assigned to event tasks as they are originally entered into WDMS. This number will not exceed 12 for any event.</p>
<p><b>24.</b> "Trial Responses" shows the sequence of response symbols for each task. The reviewer should evaluate the trend of these responses to determine there is a potential MWD team detection deficiency. The total time the aid was planted [Time Set to 1st Trial Time] may be a factor depending on odor dissipation.</p>
<p><b>25.</b> BLANK/NO-AID events are reported in detail on this tab. There should only be one task per event. Any response is recorded as a FALSE response; otherwise only time, conditions and comments are shown.</p>
<p><b>26.</b> Trainer and evaluator comments recorded about the qualification events are reported in the bottom section with reference to the assigned event number used in the top section.</p>

NAVMC 11818-1 MWD Activity Report Tab 6A - Combat Tracker Summary

UNITED STATES MARINE CORPS MILITARY WORKING DOG ACTIVITY REPORT Combat Tracker Summary		1 MONTH AND YEAR																														
2. NAME OF DOG	3. BRAND	4. AGE (YEARS)	5. MWD TYPE	6. ORGANIZATION AND LOCATION																												
7. UNTRAINED/UNUSED (See Legend)		8. DAY OF MONTH AND RATING																														
		1	2	3	4	5	6	7	8	9	10	11	12	13	14	15	16	17	18	19	20	21	22	23	24	25	26	27	28	29	30	31
SECTION I - TRACKING EVENTS		Total																														
A. QUALIFICATION (T+V)																																
(1) NUMBER OF TRACKS		0																														
(2) TRACK TIME																																
B. UTILIZATION																																
(1) NUMBER OF TRACKS		0																														
(2) TRACK TIME																																
SECTION II - TOTALS																																
A. UTILIZATION TIME (Hr:Min)																																
B. TRAINING (T) TIME (Hr:Min)																																
C. VALIDATION (V) TIME (Hr:Min)																																
D. TOTAL ACTIVITY TIME (Hr:Min)																																

NOTE: CT=Caretakeer Only, IT=MWD in Transit, LV=Leave, MS=MWD Sick, MT=MWD TAD, OC=On Call, OD=Off Duty, OT=Other, RG=Range, T=Training, TD=TAD, V=Validation

9. TRAINER'S INITIALS

NOTE Refer to the MWD Service Record folder for the current MWD Team Tracker Validation Report.

10. REPORT DATE

NAVMC 11818-1 MWD Team Activity Report, TAB 6A - Combat Tracker Summary [WDMS Generated] (JAN 2014)

27

27. The reviewer should determine if the total number of tracks conducted during the month is sufficient to the standards in Appendix D. High utilization activity can be considered when determining if additional training is required.

<b>NAVMC 11818-1</b>	<b>MWD Activity Report</b>	<b>Tab 6B - Combat Tracker Data</b>
----------------------	----------------------------	-------------------------------------

UNITED STATES MARINE CORPS MILITARY WORKING DOG ACTIVITY REPORT Combat Tracker Data												1 MONTH AND YEAR
2. NAME OF DOG	3. BRAND	4. AGE (YEARS)	5. MWD TYPE	6. ORGANIZATION AND LOCATION				WIND SPEED				
				DELIBERATE MOVEMENTS	WEA THER	WIND DIRECTION	TEMP					
28. TRACK NO.	29. EVENT TYPE	EVENT RATING	QUARRY FOUND	NO. QUARRY	DURATION (Hr:Min)	LOCATION		STARTING POINT	NO. SURFACES	SURFACES	NO. MOVEMENTS	
	EVALUATOR	TRACK TYPE	DAY/NIGHT	SPT CAT	ARTICLE FOUND	AGE OF TRACK (Hr:Min)	DISTANCE (meters)	NO. OBSTACLES	OBSTACLES	ALERT DIST. (meters)		
1												
<b>LEGEND:</b> BCA=Base Ops-CAR, BCT=Base Ops-COV1, BME=Base Ops-MEVA, BO=Base Ops-Other, BOP=Base Ops-Patrol, BRM=Base Ops-RAM, BVS=Base Ops-VIP, CA=City Agency, CBP=Customs Border Protection, CS=County Agency, DCO=Deployment/Combat Ops, DEA=Drug Enforcement Agency, DOS=Dept of State, DIS=Dept of Homeland Sec, OBI=Off Base-Other, OBO=Off Base-Other, OT= Other, S=Satisfactory, SA=State Agency Spt, T=Training, U=Unsatisfactory, UMS=U.S. Maritime Svc, TSA=Texas Sec Agency, ISS=Secret Svc, UT=Utilization, V=Validation												
30. TRACK NO.	COMMENTS											
1												

**28.** The "Track No." is the system assigned sequential number for all tracks recorded during the month. This number is only seen on this report.

**29.** The field "Quarry Found" is a good indicator of team performance. Consistent recording of no-quarry-found tracks may require additional evaluation by the reviewers to determine if a deficiency exists. "Quarry Found" and "Event Rating" should be consistent.

**30.** Comments recorded about the track are reported in the bottom section with reference to the assigned track number used in the top section. Comments are a combination of those entered by the handler and a qualification event evaluator.

NAVMC 11818-1	MWD Activity Report	Tab 7 - Daily Synopsis
---------------	---------------------	------------------------

1. Month and Year	
UNITED STATES MARINE CORPS MILITARY WORKING DOG ACTIVITY REPORT Daily Synopsis	
2. NAME OF DOG	
3. BRAND	
5. MWD TYPE	
6. ORG / LOC	
<b>Date</b>	<b>COMMENTS [Basic &amp; Patrol Skills]    NOTE: Detection &amp; Tracking comments on training activity tabs.</b>
<b>31</b>	
NAVMC 11818-1 MWD Team Activity Report, TAB 7 - Daily Synopsis [WDMS Generated] (JAN 2014)	

**31.** The Daily Synopsis contains a chronological accounting of all days in the month if in fact a daily entry was recorded in the Basic Skills or Patrol comments field OR a reason for Untrained/Unutilized was recorded. It is possible to have open dates. Comments associated with detection (validation/certification) and tracking (validation) events are recorded at the bottom of the associated data tabs [particular attention should be given to granting of extended validations].

<b>NAVMC 11818-19</b>	<b>Basic Skills Validation Report</b>
-----------------------	---------------------------------------

- One page document that summarizes the qualification activity for Basic Skills as recorded in WDMS.
- Generated by WDMS using the request feature under "Kennel Master / Reports" tab or at the time the validation is recorded.
- Signed by the kennel master or appointee in his/her absence.

<b>United States Marine Corps Military Working Dog (MWD) Basic Skills Validation Report</b>				
1. MWD NAME	2. BRAND	3. TYPE	4. BREED	5. WHELP DATE
6. HANDLER [Rank, First Name, Last Name]				
7. BASIC SKILLS [Required for <u>All</u> MWD/CPWD Teams]				
A. EVENT 1 - OBEDIENCE [On Leash]		B. EVENT 2 - OBSTACLE COURSE		C. EVENT 3 - GUNFIRE
DATE:		DATE:		DATE:
EVALUATOR:		EVALUATOR:		EVALUATOR:
<b>TASKS</b>	<b>PASS</b>	<b>N/A *</b>		<b>N/A *</b>
(1) Heeling		* A copy of the signed waiver must be in the MWD Service Record to not validate on the obstacle course.		* A copy of the signed waiver must be in the MWD Service Record to not validate on the obstacle course.
(2) Down from Heel		<b>PASS</b>		<b>PASS</b>
(3) Sit from Down		Obstacle Course		Gunfire
(4) Stay		Consist of Tasks:		<b>TASKS</b>
(5) Down at End of Leash		(1) Dog-Walk	(5) Hurdle #1	(1) Other [50'] - (4 minimum)
(6) Sit at End of Leash		(2) Stairs/Steps	(6) Hurdle #2	(2) Other [10'] - (4 minimum)
(7) Recall to Heel		(3) A-Frame	(7) Hurdle #3	(3) Other [<6'] - (2 minimum)
		(4) Window Hurdle	(8) Tunnel	(4) Handler [at heel] - (10 minimum)
<b>PASS</b>				
WAS EXTENDED VALIDATION GRANTED?			D. Basic Skills Validation(Pass Parts A-C)	
8. COMMENTS: [Include the event date with comments about granting an extended validation.]				
Validation Start Date is the date of the last successful event. Validation is current for 180 calendar days.				
9. VALIDATION START DATE:	10. VALIDATION END DATE:		11. <u>Limited</u> Due to Waiver in Events <u>1</u> or <u>2</u> ?	
Events were conducted in accordance with the evaluation guide in MCO 5585, Appendix D, Tab 1.				
NOTE: The signing evaluator is the senior individual overseeing the qualification process although different designees may actually evaluate the parts of the validation conducted on various days.				
12. TYPED/PRINTED NAME, GRADE AND TITLE OF EVALUATOR			13. EVALUATOR SIGNATURE	
The signed original of this document is to be filed in the MWD Service Record folder.				
NAVMC 11818-19 - MWD Basic Skills Validation Report [WDMS Generated] (DEC 2012)				

<b>NAVMC 11818-20</b>		<b>Patrol Validation Report</b>			
<ul style="list-style-type: none"> <li>• One page document that summarizes the qualification activity for Patrol Skills as recorded in WDMS.</li> <li>• Generated by WDMS using the request feature under "Kennel Master / Reports" tab or at the time the validation is recorded.</li> <li>• Signed by the kennel master or appointee in his/her absence.</li> </ul>					
<b>United States Marine Corps Military Working Dog (MWD) Patrol Validation Report</b>					
1. MWD NAME	2. BRAND	3. TYPE	4. BREED	5. WHELP	
6. HANDLER [Rank, First Name, Last Name]					
7. PATROL SKILLS [Required for <u>All</u> Patrol Designated MWD/CPWD Teams]					
A. EVENT 1 - CONTROLLED AGGRESSION		B. INTRUDER DETECTION			
DATE:					
EVALUATOR:					
TASKS	PASS	EVENTS	PASS	DATE:	EVALUATOR
(1) Field Interview		(1) Building Search			
(2) Pursuit and Attack		(2) Sight Scouting _____ meters			
(3) Stand Off		(3) Scent Scouting _____ meters			
(4) Search and Escort		(4) Sound Scouting _____ meters			
(5) Search and Re-Attack		<b>PASS</b>			
WAS EXTENDED VALIDATION GRANTED?		C. Patrol Validation (Pass Parts A-B)			
8. COMMENTS: [Include the event date with comments about granting an extended validation]					
Validation Start Date is the date of the last successful event. Validation is current for 180 calendar days.					
9. VALIDATION START DATE:			10. VALIDATION END DATE:		
Events were conducted in accordance with the evaluation guide in MCO 5585, Appendix D, Tab 2.					
NOTE: The signing evaluator is the senior individual overseeing the qualification process although different designees may actually evaluate the parts of the validation conducted on various days.					
11. TYPED/PRINTED NAME, GRADE AND TITLE OF EVALUATOR			12. EVALUATOR SIGNATURE		
The signed original of this document is to be filed in the MWD Service Record folder.					
NAVMC 11818-20 - MWD Patrol Validation Report [WDMS Generated] (DEC 2010)					

<b>NAVMC 11818-21</b>	<b>Detection Validation Report</b>
<ul style="list-style-type: none"> <li>Multi page document that summarizes the qualification activity for Detection skills [both drug and explosive] as recorded in WDMS.</li> <li>Additional pages printed as required to provide detail of detection events (two per page to a max of five events).</li> <li>Generated by WDMS using the request feature under "Kennel Master / Reports" tab or at the time the validation is recorded.</li> <li>Signed by the kennel master or appointee in his/her absence.</li> </ul>	

**United States Marine Corps  
Military Working Dog (MWD)  
Detection Validation Report**

1. MWD NAME	2. BREED	3. TYPE	4. AGE	5. WEIGH DATE	<b>1st Page</b>		
6. HANDLER (Last, First Name, Last Name)				8. ORGANIZATION AND LOCATION			
7. DETECTION SKILLS (DRUG & EXPLOSIVE) [Required for All Detection Designated MWD Teams]							
<b>A. DETECTION RESULTS</b>							
TRAINING AID (See authorized aids listing) [Note 2]	Tasks [Note 1]	Totals	+ Resp	Accuracy % (= Resp / Totals)	Event Date	Event Evaluator	Extended Validation Granted?
<b>Totals</b>	0	0	0	0	[Note 3]		
					[Note 4]		
					[Note 5]		
<b>B. Validation Criteria Notes</b>						<b>AUTHORIZED TRAINING AIDS</b>	
Notes 1: Minimum 2 tasks per available odor							
Notes 2: Minimum 1 Event - Blank/No Aid							
Notes 3: Minimum overall detection accuracy [90%-Drug, 95%-Explosive]							
Notes 4: Maximum one total false response (FR). (FR) = Max two total false responses							
Notes 5: Maximum 3 total fringe responses							
Notes 6: Minimum 3 search areas used (S&D ONLY - Minimum 4 search areas used)							
Notes 7: (S&D ONLY) Minimum one night event							
Notes 8: (S&D ONLY) Minimum one buried aid							
<b>C. DETECTION VALIDATION [Pass all above criteria]</b>						Blank/No-Aid [No Aid] (required event w/o odor)	
* COMMENTS: [Include the event date with comments about granting an extended validation and justification why any required odor was not used for this validation.] * Ammonium Nitrate Dynamite [AD] is an acceptable substitute training aid for Nitroglycerin Dynamite [ND].							

**United States Marine Corps  
Military Working Dog (MWD)  
Detection Validation Event Details**

1. ORGANIZATION AND LOCATION															
2. TEAM INFORMATION															
Validation Start Date is the date of the last successful detection		MWD NAME	MWD SERVICE	MWD CAPABILITY	HANDLER (Last, First Name, FI.)										
3. VALIDATION START DATE:	10. VALIDATION END DATE:	11. VALIDATING PVT DATE:		FIRST DATE	NIGHT EVENT?	START TIME	END TIME								
NOTE: The signing evaluator is the senior individual overseeing the qual. The details about each valid.				DRUG AREA	WEAPONS	EVALUATOR (Last, First Name, FI.)									
12. TYPE/PRINTED NAME, GRADE AND TITLE OF EVALUATOR															
13. THE SIGNED ORIGINAL OF THIS DOCUMENT IS TO BE THE DETAILS ABOUT EACH VALID.															
NAVMC 11818-21 - MWD Detection Validation Report, Sheet 1 (MWD Name)															
EVENT CONFIGURATION															
TASK NO.	TRAINING AID (See authorized aids listing on Sheet 1)	QUANTITY (See key)	BURIED	SEARCHED	DETECT	TIME SET	LOCATION	1ST RESPONSE TIME	RESPONSES	Total Trials (A)	Total + Resp (B)	Task Accuracy (B/A)	FALSE RES	FRINGE RESP	TASK NO.
1															1
2															2
3															3
4															4
5															5
6															6
7															7
8															8
9															9
10															10
Comments about event configuration:										<b>TOTALS</b>					
										<b>OVERALL ACCURACY (B/A)</b>					
										Comments about team results:					
NAVMC 11818-21 - MWD Detection Event Data Sheet - 2 (One Per Event) (MWD Generated) (R&R 2018)															

Supplement Page

<b>NAVMC 11818-22</b>	<b>Tracking Validation Report</b>
<ul style="list-style-type: none"> <li>Multi page document that summarizes the qualification activity for Detection</li> <li>Multi page document that summarizes the qualification activity for tracking skills as recorded in WDMS.</li> <li>Additional pages printed as required to provide detail of tracking events (one per page to a max of four events).</li> <li>Generated by WDMS using the request feature under "Kennel Master / Reports" tab or at the time the validation is recorded.</li> <li>Signed by the kennel master or appointee in his/her absence.</li> </ul>	

United States Marine Corps Military Working Dog (MWD) Tracking Validation Report				
1. MWD NAME	2. BRAND	3. TYPE	4. BREED	5. WHELP DATE
6. HANDLER [Rank, First Name, Last Name]				
7. TRACKING SKILLS [Required for All Combat Tracking Designated MWD/CPWD Teams]				
<b>A. TRACKING RESULTS</b>				
	TRACK EVENT #1	TRACK EVENT #2	TRACK EVENT #3	TRACK EVENT #4
DATE:				
EVALUATOR:				
<b>TRACK DATA</b>				
(1) Type				
(2) Day or Night Track [NOTE 1]				
(3) Distance (Meters)				
(4) Number of Deliberate Movements				
(5) Age of Track (Hr:Min)				
(6) Number of Obstacles				
(7) Number of Surfaces Crossed				
(8) Quarry Found (Y/N) [NOTE 2]				
<b>B. Validation Criteria Notes</b>				
	Result	PASS	FAIL	
Note 1: Minimum one night track				
Note 2: Minimum 2 tracks that quarry is found				
<b>C. TRACKING VALIDATION [Pass all above criteria]</b>				
8. COMMENTS:				
UNITED STATES MARINE CORPS MILITARY WORKING DOG PROGRAM Validation Track #1 Details				
1. IBD SECTION				
2. EVENT DATE	3. LOCATION	4. TRACK TYPE	5. DAY / NIGHT	
<b>6. TEAM INFORMATION</b>				
MWD NAME	MWD BRAND	MWD CAPABILITY	HANDLER	
<b>7. CONDITIONS</b>				
WEATHER		WIND SPEED		WIND DIRECTION
TEMPERATURE		HUMIDITY		
<b>8. TRACK START</b>				
START TIME		END TIME	STARTING POINT	
<b>9. TRACK DATA</b>				
DISTANCE		METERS	AGE OF TRACK	HOURS MINUTES
<b>ARTICLE FOUND</b>				
OBSTACLES		TOTAL NUMBER	COMMENTS:	
			Fence	Log Ravine Tunnel Wall Window
			Water	Other
SURFACES		TOTAL NUMBER	Asphalt	Cement Gravel Mud Rocky Sand
			Snow	Vegetation Dust
DELIBERATE MOVEMENTS		TOTAL NUMBER	45 Degrees	Left Turn Circle P Turn Other
			90 Degrees	Right Turn Dog Leg Back Turn
<b>10. TRACK RESULTS</b>				
QUARRY FOUND		ALERT DESCRIPTION	NUMBER OF QUARRY FOUND	ALERT DISTANCE FROM QUARRY METERS
11. COMMENTS:				
Supplement Page				
(Rank Last Name FI)				SHEET 2 OF 5
NAVMC 11818-22 - MWD Tracking Validation Report, Sheet 2, Track Detail [WDMS Generated] (DEC 2012)				



**NAVMC 11818-23 Detection Certification Report**

- Multi page document that summarizes the certification demonstration activity for detection skills [both drug and explosive] as recorded in WDMS.
- Additional pages printed as required to provide detail of detection events (two per page to a max of four events).
- Generated by WDMS using the request feature under "Kennel Master / Reports" tab or at the time the certification is recorded.
- Signed by the kennel master or appointee in his/her absence.

**United States Marine Corps  
Military Working Dog (MWD)  
Detection Certification Report**

1<sup>st</sup> Page

1. MWD NAME	2. TATTOO	3. TYPE	4. RISK	5. EVENT DATE		
6A. HANDLER (Rank, First Name, Last Name)			6B. ORGANIZATION AND LOCATION			
7. DETECTION SKILLS [Required ONLY for Detection (Drug & Explosive)] MWD Teams to be used for local probable cause searches as granted by the established probable cause authority.						
<b>A. DETECTION RESULTS</b>						
TRAINING AID (see authorized aids listing)	Tasks (Risk 1)	Totals	+ Resp	Accuracy % (+ Resp / Totals)	Event Date	Event Evaluator
Totals	0	0	0	[Risk X]		
				False Responses	0	[Risk X]
				Fringe Responses	0	[Risk X]

<b>B. Certification Criteria Notes</b>					<b>AUTHORIZED TRAINING AIDS</b>									
Result					PASS					FAIL				
Note 1: Minimum 1 task per available odor					EXPLOSIVE		NON-EXPLOSIVE			DHS/D				
Note 2: Minimum overall detection accuracy [90%-Drug, 95%-Explosive]					(1) Nitroglycerin Dynamite (ND) *		(2) Ammonium Nitrate (AN)			(3) Cocaine (CO)				
Note 3: Maximum 1 total false responses					(3) C-4 (C4)		(4) Potassium Chlorate (KC)			(2) Heroin (HE)				
Note 4: Maximum 1 total fringe responses					(5) Detection Card (DC)		(10) Sodium Chlorate (SC)			(3) Seizey (SEIZ)				
					(6) Seizure (SE)					(4) Methamphetamine (ME)				
					(8) Seizure Swisher (SS)					(5) Marijuana (MJ)				
					(4) Time Free (TF)									
					(7) BW (BW)									
<b>C. DETECTION CERTIFICATION</b> [Pass all above criteria]					Blank/No-Aid [No Aid] (required event w/o odor)									

\* means: [Include justification why any required odor was not used for this certification.] \* Ammonium Nitrate Dynamite [AD] is an acceptable substitute training aid for Nitroglycerin Dynamite [ND].

---

United States Marine Corps Military Working Dog (MWD) Detection Certification Event Details											
Certification Start Date is the date of the last successful detection											
1. ORGANIZATION AND LOCATION											
2. TEAM INFORMATION											
MWD NAME			MWD TATTOO			MWD CAPABILITY			HANDLER (Rank, Last Name, FI.)		
3. CERTIFICATION START DATE		10. CERTIFICATION END DATE		11. CERTIFICATION TYPE		EVENT DATE		EVENT EVENT		EVENT TIME	
LOCATION						WEATHER		EVALUATOR (Rank, Last Name, FI.)			
13. TYPE/WRITER NAME, GRADE AND TITLE OF EVALUATOR											
14. TYPE/WRITER NAME, GRADE AND TITLE OF WOODWARD HEADQUARTERS AUTHORITY											
15. TYPE/WRITER NAME, GRADE AND TITLE OF WOODWARD HEADQUARTERS AUTHORITY											
16. TYPE/WRITER NAME, GRADE AND TITLE OF WOODWARD HEADQUARTERS AUTHORITY											
17. TYPE/WRITER NAME, GRADE AND TITLE OF WOODWARD HEADQUARTERS AUTHORITY											
18. TYPE/WRITER NAME, GRADE AND TITLE OF WOODWARD HEADQUARTERS AUTHORITY											
19. TYPE/WRITER NAME, GRADE AND TITLE OF WOODWARD HEADQUARTERS AUTHORITY											
20. TYPE/WRITER NAME, GRADE AND TITLE OF WOODWARD HEADQUARTERS AUTHORITY											
21. TYPE/WRITER NAME, GRADE AND TITLE OF WOODWARD HEADQUARTERS AUTHORITY											
22. TYPE/WRITER NAME, GRADE AND TITLE OF WOODWARD HEADQUARTERS AUTHORITY											
23. TYPE/WRITER NAME, GRADE AND TITLE OF WOODWARD HEADQUARTERS AUTHORITY											
24. TYPE/WRITER NAME, GRADE AND TITLE OF WOODWARD HEADQUARTERS AUTHORITY											
25. TYPE/WRITER NAME, GRADE AND TITLE OF WOODWARD HEADQUARTERS AUTHORITY											
26. TYPE/WRITER NAME, GRADE AND TITLE OF WOODWARD HEADQUARTERS AUTHORITY											
27. TYPE/WRITER NAME, GRADE AND TITLE OF WOODWARD HEADQUARTERS AUTHORITY											
28. TYPE/WRITER NAME, GRADE AND TITLE OF WOODWARD HEADQUARTERS AUTHORITY											
29. TYPE/WRITER NAME, GRADE AND TITLE OF WOODWARD HEADQUARTERS AUTHORITY											
30. TYPE/WRITER NAME, GRADE AND TITLE OF WOODWARD HEADQUARTERS AUTHORITY											
31. TYPE/WRITER NAME, GRADE AND TITLE OF WOODWARD HEADQUARTERS AUTHORITY											
32. TYPE/WRITER NAME, GRADE AND TITLE OF WOODWARD HEADQUARTERS AUTHORITY											
33. TYPE/WRITER NAME, GRADE AND TITLE OF WOODWARD HEADQUARTERS AUTHORITY											
34. TYPE/WRITER NAME, GRADE AND TITLE OF WOODWARD HEADQUARTERS AUTHORITY											
35. TYPE/WRITER NAME, GRADE AND TITLE OF WOODWARD HEADQUARTERS AUTHORITY											
36. TYPE/WRITER NAME, GRADE AND TITLE OF WOODWARD HEADQUARTERS AUTHORITY											
37. TYPE/WRITER NAME, GRADE AND TITLE OF WOODWARD HEADQUARTERS AUTHORITY											
38. TYPE/WRITER NAME, GRADE AND TITLE OF WOODWARD HEADQUARTERS AUTHORITY											
39. TYPE/WRITER NAME, GRADE AND TITLE OF WOODWARD HEADQUARTERS AUTHORITY											
40. TYPE/WRITER NAME, GRADE AND TITLE OF WOODWARD HEADQUARTERS AUTHORITY											
41. TYPE/WRITER NAME, GRADE AND TITLE OF WOODWARD HEADQUARTERS AUTHORITY											
42. TYPE/WRITER NAME, GRADE AND TITLE OF WOODWARD HEADQUARTERS AUTHORITY											
43. TYPE/WRITER NAME, GRADE AND TITLE OF WOODWARD HEADQUARTERS AUTHORITY											
44. TYPE/WRITER NAME, GRADE AND TITLE OF WOODWARD HEADQUARTERS AUTHORITY											
45. TYPE/WRITER NAME, GRADE AND TITLE OF WOODWARD HEADQUARTERS AUTHORITY											
46. TYPE/WRITER NAME, GRADE AND TITLE OF WOODWARD HEADQUARTERS AUTHORITY											
47. TYPE/WRITER NAME, GRADE AND TITLE OF WOODWARD HEADQUARTERS AUTHORITY											
48. TYPE/WRITER NAME, GRADE AND TITLE OF WOODWARD HEADQUARTERS AUTHORITY											
49. TYPE/WRITER NAME, GRADE AND TITLE OF WOODWARD HEADQUARTERS AUTHORITY											
50. TYPE/WRITER NAME, GRADE AND TITLE OF WOODWARD HEADQUARTERS AUTHORITY											
51. TYPE/WRITER NAME, GRADE AND TITLE OF WOODWARD HEADQUARTERS AUTHORITY											
52. TYPE/WRITER NAME, GRADE AND TITLE OF WOODWARD HEADQUARTERS AUTHORITY											
53. TYPE/WRITER NAME, GRADE AND TITLE OF WOODWARD HEADQUARTERS AUTHORITY											
54. TYPE/WRITER NAME, GRADE AND TITLE OF WOODWARD HEADQUARTERS AUTHORITY											
55. TYPE/WRITER NAME, GRADE AND TITLE OF WOODWARD HEADQUARTERS AUTHORITY											
56. TYPE/WRITER NAME, GRADE AND TITLE OF WOODWARD HEADQUARTERS AUTHORITY											
57. TYPE/WRITER NAME, GRADE AND TITLE OF WOODWARD HEADQUARTERS AUTHORITY											
58. TYPE/WRITER NAME, GRADE AND TITLE OF WOODWARD HEADQUARTERS AUTHORITY											
59. TYPE/WRITER NAME, GRADE AND TITLE OF WOODWARD HEADQUARTERS AUTHORITY											
60. TYPE/WRITER NAME, GRADE AND TITLE OF WOODWARD HEADQUARTERS AUTHORITY											
61. TYPE/WRITER NAME, GRADE AND TITLE OF WOODWARD HEADQUARTERS AUTHORITY											
62. TYPE/WRITER NAME, GRADE AND TITLE OF WOODWARD HEADQUARTERS AUTHORITY											
63. TYPE/WRITER NAME, GRADE AND TITLE OF WOODWARD HEADQUARTERS AUTHORITY											
64. TYPE/WRITER NAME, GRADE AND TITLE OF WOODWARD HEADQUARTERS AUTHORITY											
65. TYPE/WRITER NAME, GRADE AND TITLE OF WOODWARD HEADQUARTERS AUTHORITY											
66. TYPE/WRITER NAME, GRADE AND TITLE OF WOODWARD HEADQUARTERS AUTHORITY											
67. TYPE/WRITER NAME, GRADE AND TITLE OF WOODWARD HEADQUARTERS AUTHORITY											
68. TYPE/WRITER NAME, GRADE AND TITLE OF WOODWARD HEADQUARTERS AUTHORITY											
69. TYPE/WRITER NAME, GRADE AND TITLE OF WOODWARD HEADQUARTERS AUTHORITY											
70. TYPE/WRITER NAME, GRADE AND TITLE OF WOODWARD HEADQUARTERS AUTHORITY											
71. TYPE/WRITER NAME, GRADE AND TITLE OF WOODWARD HEADQUARTERS AUTHORITY											
72. TYPE/WRITER NAME, GRADE AND TITLE OF WOODWARD HEADQUARTERS AUTHORITY											
73. TYPE/WRITER NAME, GRADE AND TITLE OF WOODWARD HEADQUARTERS AUTHORITY											
74. TYPE/WRITER NAME, GRADE AND TITLE OF WOODWARD HEADQUARTERS AUTHORITY											
75. TYPE/WRITER NAME, GRADE AND TITLE OF WOODWARD HEADQUARTERS AUTHORITY											
76. TYPE/WRITER NAME, GRADE AND TITLE OF WOODWARD HEADQUARTERS AUTHORITY											
77. TYPE/WRITER NAME, GRADE AND TITLE OF WOODWARD HEADQUARTERS AUTHORITY											
78. TYPE/WRITER NAME, GRADE AND TITLE OF WOODWARD HEADQUARTERS AUTHORITY											
79. TYPE/WRITER NAME, GRADE AND TITLE OF WOODWARD HEADQUARTERS AUTHORITY											
80. TYPE/WRITER NAME, GRADE AND TITLE OF WOODWARD HEADQUARTERS AUTHORITY											
81. TYPE/WRITER NAME, GRADE AND TITLE OF WOODWARD HEADQUARTERS AUTHORITY											
82. TYPE/WRITER NAME, GRADE AND TITLE OF WOODWARD HEADQUARTERS AUTHORITY											
83. TYPE/WRITER NAME, GRADE AND TITLE OF WOODWARD HEADQUARTERS AUTHORITY											
84. TYPE/WRITER NAME, GRADE AND TITLE OF WOODWARD HEADQUARTERS AUTHORITY											
85. TYPE/WRITER NAME, GRADE AND TITLE OF WOODWARD HEADQUARTERS AUTHORITY											
86. TYPE/WRITER NAME, GRADE AND TITLE OF WOODWARD HEADQUARTERS AUTHORITY											
87. TYPE/WRITER NAME, GRADE AND TITLE OF WOODWARD HEADQUARTERS AUTHORITY											
88. TYPE/WRITER NAME, GRADE AND TITLE OF WOODWARD HEADQUARTERS AUTHORITY											
89. TYPE/WRITER NAME, GRADE AND TITLE OF WOODWARD HEADQUARTERS AUTHORITY											
90. TYPE/WRITER NAME, GRADE AND TITLE OF WOODWARD HEADQUARTERS AUTHORITY											
91. TYPE/WRITER NAME, GRADE AND TITLE OF WOODWARD HEADQUARTERS AUTHORITY											
92. TYPE/WRITER NAME, GRADE AND TITLE OF WOODWARD HEADQUARTERS AUTHORITY											
93. TYPE/WRITER NAME, GRADE AND TITLE OF WOODWARD HEADQUARTERS AUTHORITY											
94. TYPE/WRITER NAME, GRADE AND TITLE OF WOODWARD HEADQUARTERS AUTHORITY											
95. TYPE/WRITER NAME, GRADE AND TITLE OF WOODWARD HEADQUARTERS AUTHORITY											
96. TYPE/WRITER NAME, GRADE AND TITLE OF WOODWARD HEADQUARTERS AUTHORITY											
97. TYPE/WRITER NAME, GRADE AND TITLE OF WOODWARD HEADQUARTERS AUTHORITY											
98. TYPE/WRITER NAME, GRADE AND TITLE OF WOODWARD HEADQUARTERS AUTHORITY											
99. TYPE/WRITER NAME, GRADE AND TITLE OF WOODWARD HEADQUARTERS AUTHORITY											
100. TYPE/WRITER NAME, GRADE AND TITLE OF WOODWARD HEADQUARTERS AUTHORITY											
101. TYPE/WRITER NAME, GRADE AND TITLE OF WOODWARD HEADQUARTERS AUTHORITY											
102. TYPE/WRITER NAME, GRADE AND TITLE OF WOODWARD HEADQUARTERS AUTHORITY											
103. TYPE/WRITER NAME, GRADE AND TITLE OF WOODWARD HEADQUARTERS AUTHORITY											
104. TYPE/WRITER NAME, GRADE AND TITLE OF WOODWARD HEADQUARTERS AUTHORITY											
105. TYPE/WRITER NAME, GRADE AND TITLE OF WOODWARD HEADQUARTERS AUTHORITY											
106. TYPE/WRITER NAME, GRADE AND TITLE OF WOODWARD HEADQUARTERS AUTHORITY											
107. TYPE/WRITER NAME, GRADE AND TITLE OF WOODWARD HEADQUARTERS AUTHORITY											
108. TYPE/WRITER NAME, GRADE AND TITLE OF WOODWARD HEADQUARTERS AUTHORITY											
109. TYPE/WRITER NAME, GRADE AND TITLE OF WOODWARD HEADQUARTERS AUTHORITY											
110. TYPE/WRITER NAME, GRADE AND TITLE OF WOODWARD HEADQUARTERS AUTHORITY											

Supplement Page

Comments about event configuration: \_\_\_\_\_

Comments about team results: \_\_\_\_\_

TOTALS  
OVERALL ACCURACY (E/A) \_\_\_\_\_

Comments about team results: \_\_\_\_\_

NAVMC 11818-23 - MWD Detection Certification Report - 2 (One Pac Event) [MWD Generated] (MWD 2018)

E-36

Enclosure (2)

**APPENDIX F**

Military Working Dog (MWD) Section Operation Binders

**Table of Contents**

<u>IDENTIFICATION</u>	<u>TITLE</u>	<u>PAGE</u>
<b>PARAGRAPH</b>		
1	Purpose.....	F-1
2	Introduction.....	F-1
3	Responsibility.....	F-1
4	Binder Table of Contents.....	F-2

1. Purpose. To provide a guideline on the organization of a set of binders, referred to as the "Operations Binder", that incorporate the key documentation identified in this Order as necessary for the effective operation of the MWD section.

2. Introduction. The Marine Corps has long had a tradition that key individuals at all levels of command maintain a turnover folder that contains information that would support a smooth transition in the situation of a change in personnel. The operation of a complex one that includes management of personnel, care and training of animals, selection of and qualification of MWD teams, employment of assets in support of law enforcement efforts, storage/security/handling of controlled and hazardous substances and maintenance of a kennel site and rolling stock. All this activity involves numerous other personnel upon the installation and other government agencies. With the nature of regular rotation of military and civilian personnel, it is essential for continued effective management that policy and contact information be maintained in an organized and consistent manner at each MWD location in accordance with the direction provided in Chapter 8 of this Manual.

3. Responsibility. As the senior individual within the MWD section, the kennel master is recommended to organize and maintain the operations binders as defined in the binder table of contents. The MWD PM office is to periodically review and update the binder table of contents to reflect changes necessary for kennel operations.

4. Binder Table of Contents

**NOTE**

Actual size and number of the binders will vary depending on the organizational structure and operating complexity of the MWD section and the preference of the kennel master. Some binder content is required [as indicated in the appendix] and some material is discretionary. The sequence of the binder layout should follow the table of contents as close as possible to ensure continuity within the Marine Corps MWD community.

**MWD SECTION OPERATION BINDERS  
Table Of Contents**

- (1) Non-required items are recommended, but at Kennel Master's discretion. **Updated information in WDMS is required.**
- (2) Refer to example formats in the WDMS library for required items w/o reference.

		Required (Yes)(1)	Ref. (2)
<b>SECTION I</b>	<b>ORGANIZATION</b>		
	1.	Section Organization Chart	
	2.	Section Duties and Responsibilities	Ch 3
	3.	Section Recall Roster	Yes
<b>SECTION II</b>	<b>SECTION OPERATING STATUS</b>		
	1.	Section Operating Status Report	Ch 8
	2.	MWD Team Qualification Plan (Current)	
	3.	MWD Disposition Packages (Current)	Yes Ch 7
<b>SECTION III</b>	<b>DUTY ROSTER &amp; APPOINTMENTS</b>		
	1.	Kennel Watch Duty Roster	Yes
	2.	Command Duty Roster	
	3.	Operations Roster [Day/Night Shifts]	
	4.	Drug Custodian & User Appointment Letter	Yes Ch 11
	5.	Explosives Delegation of Authority	Yes Ch 12
<b>SECTION IV</b>	<b>SPECIAL ASSIGNMENTS</b>		
	1.	Deployments	
	2.	Missions	
	3.	Demonstrations	
<b>SECTION V</b>	<b>TRAINING</b>		
	1.	Training Area Map	
	2.	Optimum Training Plans	Ch 5
	3.	MWD Team Training Schedule	Yes Ch 5
	4.	Command Training Schedule	
<b>SECTION VI</b>	<b>LOGISTICS</b>		
	1.	MWD Food Inventory Log	Yes
	2.	Kennel General Supplies Log	
	3.	Office Supplies Log	
	4.	Vehicle Log	
	5.	Consolidated Memorandum Receipt (CMR) MWD PM Equipment Unit Equipment	Yes Ch 9
	6.	Vet Inspection Reports (past one year)	Yes Ch 9

24 FEB 2020

- (1) Non-required items are recommended, but at Kennel Master's discretion. **Updated information in WDMS is required.**
- (2) Refer to example formats in the WDMS library for required items w/o reference.

		Required (Yes)(1)	Ref. (2)
<b>SECTION VII</b>	<b>DOCUMENTS</b>		
	1.	DEA Registration	Yes Ch 11
	2.	Power of Attorney (if required)	Yes Ch 11
	3.	Letter of appointment for search granting authority designee	
	4.	Command Letter of Continuity [if applicable for new commander]	Yes Ch 5
	5.	Command Chronology	
	6.	MWD Program Emails [WDMS, etc.] (Keep for one year.)	
<b>SECTION VIII</b>	<b>OPERATING PROCEDURES</b>		
	1.	Kennel Emergency Evacuation Plan	Yes Ch 9
	2.	Explosive Training Aid SOP	Yes Ch 12
	3.	Drug Training Aid SOP	Yes Ch 11
	4.	Gunfire Training SOP [if blanks used]	Yes Ch 9
	5.	Veterinary Emergency Support Letter	Yes Ch 10
	6.	MWD Demonstration SOP	
	7.	Base Certification SOP (if applicable)	
	8.	On-The-Job Training (OJT) SOP	Yes Ch 3
9.	Section Kennel SOP <ul style="list-style-type: none"> <li>• Kennel Checks [on/off duty hours]</li> <li>• MWD Care</li> <li>• Record Keeping</li> <li>• Facility Maintenance</li> <li>• Quarantine Procedures</li> <li>• Training Procedures: <ul style="list-style-type: none"> <li>Basic Skills</li> <li>Patrol</li> <li>Detection [Drug/Explosive]</li> <li>Tracking</li> </ul> </li> </ul>	Yes	Ch 5 Ch 8 Ch 9 Ch 10 App D
<b>SECTION IX</b>	<b>ON-GOING PROJECTS</b>		
	1.	Government Travel Credit Card (GTCC)	Yes Ch 3
	2.	Passports [Base Sections]	Yes Ch 3
	3.	WDMS Accounts	Yes Ch 8
	4.	Government E-mail Accounts	
	5.	Clothing Allowance [Base Sections]	Yes Ch 3
	6.	Handler OJT Program	
<b>SECTION X</b>	<b>KM ROUTINE CHECKLISTS</b>		
	1.	Daily / Weekly / Monthly / Quarterly / Semi-Annual / Annual	
<b>SECTION XI</b>	<b>REFERENCES [Hardcopy]</b>		
	1.	USMC MWD Manual MCO 5585.5 (current version)	Yes
	2.	MWD Drug Training Aid Accountability Guide, AFMES (current edition in WMDS Library) [ <i>if section has DDD or PDDD</i> ]	Yes Ch 11

24 FEB 2020

- (1) Non-required items are recommended, but at Kennel Master's discretion. **Updated information in WDMS is required.**
- (2) Refer to example formats in the WDMS library for required items w/o reference.

			<b>Required (Yes)(1)</b>	<b>Ref. (2)</b>
	3.	MWD Handler Screening & Selection, TSWG Study, 18 May 2015 (digital copy in WMDS)	Yes	App 0
	4.	Medical Care of MWD by Handlers - US Army Vet Corps (current edition copy in WDMS)	Yes	Ch 10
	5.	MWD Disposition & Adoption Procedures - (current edition in WDMS)	Yes	Ch 7
	6.	"Integrating MWD into Counter-IED and Counterinsurgency Operations," US Army GTA 90-01-037, May 2012 (hardcopy available from MWD PM)	Yes	N/A

**APPENDIX G**

Military Working Dog (MWD) Team Training And Troubleshooting  
Techniques

**Table of Contents**

<u>IDENTIFICATION</u>	<u>TITLE</u>	<u>PAGE</u>
<b>PARAGRAPH</b>		
1	Purpose.....	G-1
2	Introduction.....	G-1
3	Scope.....	G-1
<b>TABLES</b>		
G-1	Tabs Application by MWD Type.....	G-2
<b>TABS</b>		
G1	Principles of Conditioning & Behavior Modification.....	G1-1
G2	Clear Signals Training Method.....	G2-1
G3	Deferred Final Response (DFR).....	G3-1
G4	E-Collar Training.....	G4-1
G5	Odor Imprinting.....	G5-1
G6	Basic Skills Training.....	G6-1
G7	Patrol Dog Training.....	G7-1
G8	Specialized Search Dog Training.....	G8-1
G9	Combat Tracker Dog Training.....	G9-1

1. Purpose. This appendix provides the generally accepted principles and techniques of MWD training and troubleshooting techniques which all MWD kennel masters and trainers must be knowledgeable.

2. Introduction. All MWDs are trained and certified by the 341 TRS at JBSA-Lackland to the threshold level identified in Appendix B. Once assigned to an MWD section and teamed with a handler, the MWD team must complete the New Dog introductory training as specified in table D-3 to ensure the MWD meets the threshold standards defined in Appendix B. The training process is continuous in order to maintain MWD interest and the handler's awareness to MWD response. This effort will maintain an acceptable performance level and identify performance issues that may arise from physical conditions or inadequate handler techniques.

3. Scope. These techniques described in this appendix are a collection gathered from SMEs at the 341 TRS. It is understood that no one technique works on all MWDs so it is the intent of

this appendix to provide a broad scope of ideas to be considered when confronted with an MWD team performance discrepancy, conducting advanced training to meet objective performance levels as defined in Appendix B, or striving to solve a unique operational challenge. It is recommended that each kennel master and trainer regularly review the appendix tabs as they apply to MWD types as defined in table G-1 below:

<b>Table G-1.--Tabs Application by MWD Type</b>						
<b>TAB</b>	<b>Topic</b>	<b>MWD Type</b>				
		<b>CTD</b>	<b>DDD</b>	<b>EDD</b>	<b>Patrol</b>	<b>SSD</b>
<b>G1</b>	Principles of Conditioning & Behavior Modification	<b>X</b>	<b>X</b>	<b>X</b>	<b>X</b>	<b>X</b>
<b>G2</b>	Clear Signals Training Method	<b>X</b>	<b>X</b>	<b>X</b>	<b>X</b>	<b>X</b>
<b>G3</b>	Deferred Final Response (DFR)	<b>X</b>	<b>X</b>	<b>X</b>	<b>X</b>	<b>X</b>
<b>G4</b>	E-Collar Training				<b>X</b>	<b>X</b>
<b>G5</b>	Odor Imprinting	<b>X</b>	<b>X</b>	<b>X</b>		<b>X</b>
<b>G6</b>	Basic Skills Training	<b>X</b>	<b>X</b>	<b>X</b>	<b>X</b>	<b>X</b>
<b>G7</b>	Patrol Dog Training				<b>X</b>	
<b>G8</b>	Specialized Search Dog Training					<b>X</b>
<b>G9</b>	Combat Tracker Dog Training	<b>X</b>				

**TAB G1**

Principles Of Conditioning And  
Behavior Modification

**Table of Contents**

<u>IDENTIFICATION</u>	<u>TITLE</u>	<u>PAGE</u>
<b>PARAGRAPH</b>		
1	Motivation.....	G1-1
2	Learning and Conditioning.....	G1-5
3	Classical Conditioning.....	G1-7
4	Instrumental Conditioning.....	G1-10
5	Discriminative Stimuli.....	G1-17
6	Inducive Versus Compulsive Training	G1-17
7	Application of Inducive Training...	G1-18
8	Application of Compulsive Training.	G1-22
9	Generalization of Classical and Instrumental Conditioning.....	G1-26
10	Learning Transfer.....	G1-27
11	Anticipation.....	G1-27
12	Compartmentalization.....	G1-28
<b>FIGURES</b>		
G1-1	Before Conditioning.....	G1-8
G1-2	After Conditioning.....	G1-8
G1-3	Classical Conditioning.....	G1-11
G1-4	Instrumental Conditioning.....	G1-11
<b>TABLES</b>		
G1-1	Nature of the Response Contingency.	G1-15

1. Motivation. Animals respond to the environment in order to fulfill their basic biological objectives, such as maintaining life and reproducing themselves. Animals do not perform basic behaviors like eating and mating because they feel the desire to maintain life or reproduce—they do so because nature has arranged matters so that it “feels good” to engage in these behaviors. When we train animals, we exploit the animal’s desire to “feel good” by requiring the animal to do as we wish before we allow it to engage in one of these basic motivating behaviors. Our best way of measuring the strength of a motivation is to see how much effort and trouble an animal will go to in order to get the chance to engage in a specific behavior, like eating or playing.

a. Needs and Drives. Behavioral scientists have long tried to form theories that adequately describe and explain motivation. Along the way, they have employed terms like



24 FEB 2020

"instinct," "need," and "drive" to express the idea that animals preferentially engage in certain kinds of behavior, and even exert enormous effort to get the chance to do so. These terms are no longer considered to be valid, scientifically speaking, and science has moved on to other ways of dealing with motivation. However, it is perfectly adequate to speak of "needs" or "drives" when describing behavior for the purposes of dog training. Needs range from those that are clearly physiological, like thirst, to those that are a puzzle to us because they do not seem to fulfill any immediate biological requirement for instance, the drive to engage in play behavior. In any case, no matter what the source of the drive or need we use to motivate the animal, much of dog training involves arranging matters so that the dog's desires are gratified when it behaves in desirable ways. However, before expecting the animal to learn and work, the handler must ensure the dog's primary needs are adequately met. The dog must be healthy and happy and feel an emotional bond with its trainer. The dog's needs and drives include the following:

b. Primary Drives. We will use the expression "primary drives" to refer to the motivations for those behaviors that function to prevent physiological or physical injuries.

(1) Oxygen. Breathing is perhaps the dog's most immediate need. Exercise or excitement creates an increased oxygen requirement, which causes panting. Note that heavy panting may hinder the dog's olfactory ability. In addition, keep in mind that a dog that is panting heavily may be overheated and/or physically exhausted, and is not in a physiological state that is conducive to learning. Therefore the trainer should avoid working on new lessons or problem behaviors when the dog is fatigued.

(2) Water. The trainer must provide adequate quantities of water to prevent thirst from interfering with learning or task performance. Do not use water as a reward in dog training.

(3) Food. The trainer must supply adequate quantities of food to prevent hunger from interfering with task performance. You may use food as a reward. The majority of dogs have sufficient appetite so that they will work strenuously for extra food rewards, particularly when these rewards are highly palatable "treat" foods. Food deprivation is not required. Intense physical exertion, particularly in hot conditions, should be avoided when the dog has recently eaten.

24 FEB 2020

(4) Pain Avoidance. A dog will avoid objects and actions that it has learned to associate with pain or discomfort, and this behavior is frequently exploited by dog trainers. The use of a physical correction, however, does not necessarily teach a dog the correct response to any specific cue. The trainer cannot assume the dog "knows what he did wrong." In addition, natural defensive responses to corrections may often interfere with the target behavior unless the dog already understands the desired response (e.g., pulling downwards on the choke collar to try to make the dog lie down may simply result in teaching the dog to brace its forelegs and strain upwards, unless the dog has previously learned how to lie down to earn a reward, and then learned to "turn off" collar pressure by lying down). The dog must know the correct response before the handler can use training that depends upon the dog's desire to avoid discomfort.

c. Secondary Drives. In addition to the primary needs like food and pain avoidance, the dog has other behaviors that can be exploited by providing the trainer with ways to reinforce and reward its behavior.

(1) Socialization. Dog trainers sometimes speak of the dog's desire to socialize as the "pack drive." The handler must keep in mind that one of the dog's strong drives is to enjoy a stable social relationship with one or more other beings, to "belong" to someone. A predictable and stable relationship in which the dog trusts (and has affection for) his handler is the basis of any effective system of training. This relationship does not form instantly. The handler must take the time and trouble to foster it. A period of socialization ("rapport-building") between dog and handler is required to establish this social relationship, and to render verbal and physical praise from the handler rewarding to the dog.

(a) Dominant or "Alpha" Socialization. In most cases, a dominant dog will strive to achieve rank in a pack or social group. This behavior is a normal part of the character of many working dogs. To work effectively with a highly dominant dog, the handler must gain the initiative in the relationship. However, this is not done simply by "showing the dog who is boss." Attempts to physically punish a dominant dog into cooperative behavior normally only results in handler aggression and the dog and handler becoming suspicious of one another.

(b) Subdominant or "Beta" Socialization. A subdominant dog is driven to behave in affiliative ways that will establish its belonging in the pack. These affiliative

24 FEB 2020

responses are called "submissive behavior." However, keep in mind that a dog's social rank or dominance with respect to its handler is not an index to its quality, even as a controlled aggression dog. Many strong patrol dogs are compliant and submissive with their handlers, but are capable of very strong aggression towards "outsiders" when commanded. A submissive dog will often exhibit what is called "willingness" or "eagerness to please." This behavior can greatly facilitate the dog's training if the handler has established a positive rapport with the animal. Especially in the case of a submissive dog, excessive corrections and compulsion (see tab G1, paragraph 4.g.), whether verbal or physical, can degrade rapport and decrease the dog team's proficiency in training and deployment.

(c) Play Socialization. Play is difficult to define precisely, and although scientists argue about what its purpose is, play is a distinct and identifiable behavior that occurs in a very wide range of animals. We may presume that it is one of the dog's needs, and there can be little doubt that carefree and happy play between dog and handler is a vital part of a healthy and productive training relationship.

(2) Prey. "Prey drive" is an expression that refers to the dog's natural tendency to chase, bite, and carry an item the dog perceives as prey. This applies to things that would, in the natural world, constitute prey items for a dog (e.g., a rabbit), as well as artificial objects (e.g., a thrown ball) that are also capable of triggering the dog's impulse to engage in predatory behavior. Prey behavior has enormous importance for the training of MWDs because it provides the reinforcement for nearly all substance detection training, and it also contributes very importantly to controlled aggression training. Many dogs display elements of social play behavior while retrieving balls and toys, and balls and toys can be thought of as play facilitators in addition to surrogate prey objects.

(3) Aggression. Even though there is not much evidence that animals have a "need" to behave aggressively, dog trainers still tend to speak of aggressive behavior as being based on one or more "drives." There are many different types of aggression, including dominant, defensive, and pain-elicited aggression. Aggression plays a vital role in MWD training and utilization because it is the foundation of patrol work. In addition, because MWDs are selected for a moderate to high level of aggressiveness, an MWD handler must at all times be aware of his or her dog's potential for aggressive behavior. The MWD handler must handle his/her dog responsibly and with care to prevent

injuries to him/herself, to the dog, to other dogs, and to bystanders and co-workers. The handler must also help to prevent the development of handler-aggressiveness in his/her dog by:

(a) Treating the animal compassionately, humanely and fairly.

(b) Avoiding a reliance on strict or overly-compulsive methods for training (see tab G1, paragraph 4.g).

(c) Ensuring at all times that the dog clearly understands how to perform the desired skills.

(d) Renouncing emotionality – When you get angry and frustrated with your dog, put him/her up and think the situation over!

2. Learning and Conditioning. Learning is a permanent change in the behavior of an organism as a result of interaction with the environment. This definition distinguishes learning-based behavior change from other short-term behavior changes such as sensitization, fatigue, and sensory adaptation. The terms learning and conditioning are synonymous. For the purpose of dog training, it is sufficient to discuss three types of learning: habituation, classical conditioning, and instrumental conditioning.

a. Habituation. Habituation is a gradual decrease in the strength of responsiveness to a stimulus as a result of repeated experience with that stimulus. Think of habituation as a mechanism by which organisms learn what to pay attention to and what to ignore. For instance, the first time a dog hears a door slam it may startle. In all likelihood, when it hears this slam again and again, it will gradually startle less and less until finally it exhibits very little response. This is adaptive because it allows the dog to save its energy and attention for more important events and stimuli, such as the noise of the lid coming off of the dog-food can. Habituation takes place continually during dog training, in ways that are both advantageous and disadvantageous to the dog trainer.

24 FEB 2020

(1) Advantageous Habituation. Dogs are normally to some extent frightened of, or interested in, things that are new to them. However, MWDs are expected to carry out their duties in environments that feature very distracting and sometimes intense stimuli, such as taxiing airplanes and marching formations of personnel. Through habituation a working dog can learn to respond minimally to irrelevant stimuli and pay attention to his/her "job".

(2) Procedures for Advantageous Habituation. Habituation proceeds most effectively and rapidly with stimuli that are mild or moderate in intensity. (In fact, if a fearful dog is exposed repeatedly to a very intense stimulation, such as a running helicopter engine at close range, the animal is likely to respond more intensely to this stimulus over time instead of less intensely). Habituation is most efficient when the stimulus exposures and training sessions are distributed or well-separated in time. For example, a dog can learn more easily to stop being startled by gunshots when the gunshots are spaced out at intervals of 15 or 20 seconds, and when the training sessions are separated by 24 hours. The opposite procedure, exposing the dog to rapid series of gunshots several times a day, may lead to increased fear of the noise. When habituation is conducted with mild stimuli on a distributed basis, undesirable responses such as fear tend to disappear more or less permanently.

(3) Hierarchies of Intensity. Sometimes the trainer needs to cause a decrease in undesirable responding (i.e., fear) to a very intense stimulus, such as gunshots or jet engines, yet repeated exposure to these stimuli at full-strength is likely to produce even more undesirable responding. In order to cause habituation to these intense stimuli, it is necessary to modify them so that they become milder. A practical way to decrease the intensity of noise stimuli is by exposing the dog to them at a great distance. For instance, once the dog exhibits little fear to a jet engine at 500 yards, then the animal can be brought a little closer, and so on. The scale of noise intensity, ranging from very mild to very intense, is called a hierarchy. By introducing the dog to the stimulus at a level of intensity that is so low that it provokes very little or no fear responding, and by moving very slowly and gradually from one stage on the hierarchy of intensity to the next, the trainer may be able to teach his/her dog to eventually exhibit little fear in the presence of even very intense stimuli.

24 FEB 2020

(4) Counter Conditioning. Habituation processes can be made more powerful by exploiting another stimulus (e.g., food or ball) to offset the behavioral reaction (fear) caused by the stimulus we want the dog to be less sensitive to (e.g., jet engine). If we are far enough "down" the hierarchy, far enough away from the jet engine, the dog will become oblivious to the noise and intent on eating or playing. The pleasant emotional reactions to the food or ball will counter condition the jet engine, reducing the fear response to it. However, if we are too far "up" the hierarchy, too close to the frightening jet engine, we will instead find that the jet engine will counter condition the food or ball, reducing the dog's pleasurable response to these motivators.

**Note:** Counter conditioning is actually a form of classical conditioning (see tab G1, paragraph 3.), but it is introduced here for the sake of clarity.

(5) Spontaneous Recovery. Fear responses, especially, are very durable and persistent. They tend to re-emerge even after extensive training. In fact, because habituation includes certain short-term processes that "wear off" after a few minutes or hours, it is normal for a habituated response to re-appear to some extent between training sessions. Thus a dog may exhibit no fear of a stimulus by the end of one day's training session, yet show recovered fear at the beginning of the next day's session.

b. Disadvantageous Habituation. In some circumstances, effective performance in a working dog also depends upon a certain level of interest in, and responsiveness to, environmental stimuli and routines. A dog that is relatively new to detection work, or obedience, or patrol training, may deliver very animated and lively performance because it is still stimulated and excited by these situations. The disinterested and inefficient performance that a dog handler often describes by saying "my dog is bored with the work" may be the result of habituation to training and deployment scenarios. This is disadvantageous habituation. To some extent, we can retard and offset disadvantageous habituation by changing the training scenarios constantly and offering the MWD as much variety in its daily work as possible (in addition to effective and timely positive reinforcement, see tab G1, paragraph 4.d.(1)).

3. Classical Conditioning. In this form of learning (also called Pavlovian conditioning) the dog learns that there is a relationship between two events, or stimuli. One of these

stimuli is a "neutral" or unimportant stimulus like the ringing of a bell, something that a dog would normally pay little attention to. This stimulus is called the Conditioned Stimulus, or CS, because it can generate strong behavior only as a result of conditioning. The other stimulus is a biologically important stimulus that a dog naturally pays a lot of attention to, like food. This stimulus is called the Unconditioned Stimulus, or US, because it can generate strong behavioral responses without any conditioning. Thus, a dog normally responds to the ringing of a small bell by merely perking its ears or looking towards the noise. However, a piece of food can cause the dog to show a great deal of strong behavior like excitement, salivation, digging and pawing, chewing, and eating. This very strong behavior caused by exposure to a US like food is called the Unconditioned Response, or UR. Through classical conditioning [see figures G1-1 & 2], the CS and the US become associated in the dog's "mind," so that the behavior that is naturally triggered by the US (the UR) comes to be triggered by the CS also. When a CS develops the ability to trigger behavior that is normally caused by a US, this learned response is called the conditioned response, or CR. In the classical example, the Russian scientist Ivan Pavlov taught dogs to salivate in response to the ringing of a bell. Pavlov did this by repeatedly pairing the bell (CS) and the food (US), presenting them close together in time. Eventually the dog learned that the bell predicted food, and then it began to salivate when he heard the bell (CR).

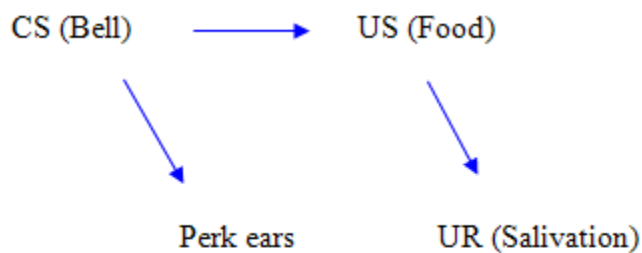

Figure G1-1: Before Conditioning

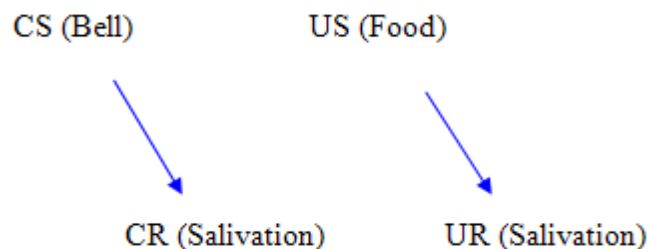

Figure G1-2.--After Conditioning

24 FEB 2020

a. Conditioning Procedures. Normally, the most effective way to "condition" a CS, to associate it with a biologically potent US, is to present the CS and then follow it very quickly (within a second or less) with the US. Thus, if the handler wishes to train his/her dog to feel startled and anxious in response to the word "NO!" then an effective method would be to wait until the dog engages in some misbehavior like sniffing the trash. The handler would then give the "NO!" cue, and throw a chain choke collar into the side of the trashcan so that it makes an unpleasant sound about ½ second after the "NO!" Originally the word "NO!" (CS) will mean little to the dog and produce little change in behavior. The unpleasant noise (US) will be potent and cause a strong startle or freezing response (UR). Pairing the "NO!" with the unpleasant noise will condition startle to "NO!" (CR) within a very few CS-US pairings. Then, when the dog is engaged in misbehavior, the handler can use the "NO!" command, the dog will freeze or startle (which serves to interrupt the undesirable activity), and the handler can then call the dog to him/her and praise it. The dog will soon learn to shy away from behaviors and objects when he/she hears the "NO!" command (classical conditioning) and return to his/her handler for praise (instrumental conditioning – see tab G1, paragraph 4).

b. Backward Conditioning. When the CS and the US are reversed, so that the US actually occurs before the CS, this is called a backward conditioning procedure. Little or no learning takes place during backward conditioning. Thus, in the above example, if you first startled the dog with a loud noise and then said "NO!" you would find that you could do this many times and still the dog would not show a startle response when "NO!" was given by itself.

c. Importance of Classical Conditioning. Very little of working dog training involves the deliberate creation of classically-conditioned associations, like the above example. Most of the "action" in dog training has to do with the use of reinforcers and punishers in instrumental conditioning (see tab G1, paragraph 4.). However, it is still very important to understand classical conditioning processes because they underlie almost everything that takes place in dog training. Classically-conditioned associations help the trainer and contribute positively to training in countless ways. For instance, if a handler makes an announcement ("This is SSGT Smith of the .....") prior to sending his/her Patrol MWD into a building to search for and find a hidden agitator, the dog will



24 FEB 2020

associate the sound of the announcement (CS) with the aggressive cues and behaviors that it experiences shortly thereafter (US) when it finds the agitator and bites. It will begin to exhibit aggressive responses to its handler's announcement, excitement and barking (CR), that help to prepare it for the search and the bite. However, classically-conditioned associations may also interfere with training. For instance, if the handler decides that his/her dog sits too slowly in response to the command, he/she may decide to hasten the sit by applying physical force. The handler gives the command "SIT!" in a loud voice, watches for a moment to see if the dog is sitting, and then gives a strong jerk upwards on the choke chain. The handler intends to demonstrate to the dog the consequence of sitting slowly, but unwittingly he/she actually constructs a very effective classical conditioning trial. "SIT!" is immediately followed by a sharp jerk on the collar. Soon "SIT!" develops the power to trigger responses that are normally only triggered by a sharp collar correction. These responses can range from pain-elicited aggression and biting to avoidance and cowering. More commonly, they involve anxiety and a reflexive stiffening of the body's muscles to defend against the sharp jerk on the collar. Thus, although the handler intends to speed the sit up, he/she is actually teaching the dog to respond to the "SIT!" command with anxiety and stiffening. The physical stiffening hinders the dog's ability to sit quickly, with the result that it receives yet another jerk on the neck, which makes it even more anxious and stiff when it hears "SIT!" and so on.

d. Extinction of Classically-Conditioned Behavior. In order to make a classically-conditioned behavior disappear, what we must do is present the CS repeatedly over and over again without pairing it with the US. The CR will gradually decrease in strength until it disappears. This procedure is called extinction. It is just like habituation procedures, except in habituation we are getting rid of an unlearned response, whereas in extinction we are getting rid of a learned response. Keep in mind that, just because a learned behavior has been extinguished, this does not mean that it has been unlearned or "erased." There is much evidence that learning causes permanent changes in the brain that are not reversed by extinction.

4. Instrumental Conditioning. Instrumental conditioning and operant conditioning mean almost the same thing, except that instrumental conditioning is a slightly more general and flexible term. Instrumental conditioning refers to the way that rewards and punishments change the strength, or probability of occurrence, of prior behavior. Another way to put this is to

say that behavior is modified by its consequences. Thus if a dog engages in a particular behavior such as investigating an odor, and then he encounters food, the odor-investigation behavior will be more likely to occur again in the future, and/or stronger when it does occur. This is an example of reinforcement. On the other hand, if a dog investigates an odor, and then he receives a jerk on the collar from his/her handler, the odor-investigation behavior will be less likely to occur in the future, and/or weaker when it does occur. This is an example of punishment.

a. Distinction Between Classical Conditioning and Instrumental Conditioning. For the purposes of dog training, it is adequate to think of classical and instrumental conditioning as separate processes that can be distinguished from one another in the following ways: Classical conditioning involves learning that there is a relationship between two environmental events, or stimuli, such as the ring of a bell and food, or the command "NO!" and an unpleasant event. Instrumental conditioning mainly involves the animal learning that there is a relationship between its own behavior and some stimulus, such as the act of sitting and praise from the handler, or the act of searching for odor and a ball. Classical conditioning [figure G1-3] affects mainly what are called autonomic responses; things like reflexes and feelings and emotions that are not under the dog's voluntary control. Instrumental conditioning [figure G1-4] affects mainly what are called skeletal responses; behaviors like sitting, running, standing, and biting that are under the dog's voluntary control.

**Stimulus/CS (Bell)                      Association                      Stimulus/US (Food)**  
**CR—Salivation (involuntary behavior)**

Figure G1-3.--Classical Conditioning

**Response (Sit)                      Association                      Stimulus/Consequence (Food)**  
**Instrumental response--- Sit (voluntary behavior)**

Figure G1-4.--Instrumental Conditioning

b. Response Contingency. Contingency is a term that refers to a relationship between two occurrences. When we say that one event is contingent on another that means that one event will

24 FEB 2020

not occur unless the other occurs. In instrumental conditioning there is a contingency between a particular behavior, or response, and a stimulus. Thus a handler will not give his/her dog food unless the animal first sits. The relationship between sitting and food in this example is called a positive response contingency. This is a final and very important distinction between classical and instrumental conditioning. In classical conditioning, there is no response contingency. Pavlov did not ring the bell and wait for the dog to salivate before rewarding the animal with food, he merely rang the bell and then presented food, regardless of what the dog did.

(1) Positive Response Contingency. This is a relationship between a response/behavior and a specified event such that if the behavior occurs it will be followed by the event. For instance, if the dog sits, his/her handler will give it food. On the other hand, if the dog tries to bite another dog, his/her handler will give it a jerk on the leash. Even though this last example does not sound "positive" because it is not pleasant for the dog, it is still a positive response contingency. In the language of learning, "positive" is not used to refer to pleasantness. It is used to say that one thing will happen provided that another happens first.

(2) Negative Response Contingency. A relationship between a behavior and specified event such that if the behavior occurs it will NOT be followed by the event. For instance, if the dog sits, his/her handler will not give him/her a jerk on the leash. Similarly, if the dog fails to find a hidden training aid, its handler will not allow it to have the ball. Although this last example does not sound "negative" because it does not involve anything unpleasant happening to the dog, it is still referred to as a negative response contingency. In the language of learning, "negative" is not used to refer to unpleasantness. It is used to say that one thing will not happen if another happens first.

c. Consequence. A consequence is an event that happens to the dog after it performs some instrumental behavior. There are two main categories of consequence (reinforcement and punishment). When we combine these two types of consequence with the two types of response contingency (positive and negative), we get four possible consequences that can result from any instrumental behavior: positive and negative reinforcement, and positive and negative punishment (see tab G1, paragraph 4.f).

24 FEB 2020

(1) Reinforcement. A reinforcer is an event that encourages or strengthens prior behavior. Examples of reinforcers are food, access to a toy, or a pat on the head. Any of these, when given to the dog after it sits, tends to strengthen sitting behavior. Food, toys, and pats on the head are reinforcing because they are pleasant. However, unpleasant events can also act as reinforcers. The handler can reinforce a behavior with an unpleasant event like a jerk on the leash by withholding the jerk when the dog sits. In this example, there is a negative response contingency between sitting behavior and a jerk on the collar—if the dog sits, there will be no jerk. Although the jerk itself is unpleasant, the absence of the jerk is a "satisfying state of affairs" and will, under proper circumstances, serve to reinforce sitting behavior.

(a) Positive Reinforcement or Reward. Positive reinforcement is the use of intrinsically pleasant stimuli like food, toys, and pats on the head to strengthen and encourage prior behavior. The word "positive" does not refer to the "goodness" or "pleasantness" of the stimuli, it instead refers to the positive response contingency between a target behavior (like sitting) and the reinforcing event; if the dog sits, he/she will be given food, toy, or a pat on the head. Positive reinforcement is synonymous with reward.

(b) Negative Reinforcement. Negative reinforcement is the strengthening of behavior by using the withholding or withdrawal of intrinsically unpleasant events like jerks on the collar. The word "negative" does not refer to the "badness" or "unpleasantness" of these stimuli, instead it refers to the negative response contingency between a target behavior (like sitting) and some event; if the dog sits, he/she will NOT be given a jerk on the collar.

(2) Punishment. A punishment is an event that discourages or weakens prior behavior. Examples of punishers are jerks on the collar (collar corrections) or a bump on the nose. Either of these, when administered to a dog after he misbehaves by, for example, departing from the down-stay position without permission, will tend to weaken down-stay - breaking behavior. Collar corrections and bumps on the nose are punishing because they are unpleasant. However, pleasant events can also act as punishers. The handler can punish an undesirable behavior by withholding or taking away a pleasant stimulus like praise and petting. Thus, if the dog tends to jump up on his handler when he/she is excited, seeking attention, this behavior can be punished by withholding praise

24 FEB 2020

and attention. In this example, there is a negative response contingency between jumping-up behavior and praise and petting; if the dog jumps up, he/she will not receive praise or petting. Although the praise and petting are themselves pleasant, their absence is an "unsatisfying state of affairs" and will, under the proper circumstances, serve to punish jumping-up behavior.

(a) Positive Punishment or Punishment. Positive punishment is the use of intrinsically unpleasant stimuli like collar corrections to discourage or weaken behavior. The word "positive" does not refer to the "pleasantness" or "unpleasantness" of the stimuli, it instead refers to the positive response contingency between a target behavior (like breaking the down-stay) and the punishing event. If the dog breaks the stay, he/she will be given a collar correction. To simplify, we can use the simpler term "punishment" in place of "positive punishment."

(b) Negative Punishment or Omission. Negative punishment is the weakening or discouragement of prior behavior by withholding pleasant events like food or praise and petting. The word "negative" does not refer to the "pleasantness" or "unpleasantness" of these stimuli, instead it refers to the nature of the negative response contingency between a target behavior (like jumping up) and an event; if the dog jumps up, he/she will NOT be given praise and petting. To simplify, we can use the expression "omission" to refer to "negative punishment."

d. Contingency Square. The contingency square is a table [see table G1-1] that graphically depicts the relationships between reinforcement and punishment (i.e., the effect the instrumental procedure has on behavior) and the nature of the response contingency (positive and negative when the handler gives something to the dog or the handler withholds something from the dog). Memorizing the table will help the trainer remember each of the four possible consequences of an instrumental behavior, and their definitions. For example, take negative reinforcement, normally the most difficult of the consequences for trainers to understand. The key is to take each of the words of the term negative reinforcement and analyze it separately in order to understand whether the consequence involves pleasant or unpleasant events for the dog. "Negative" means a negative response contingency. The handler will withhold something or take something away if the dog performs a target behavior. "Reinforcement" means that the outcome will be to encourage or strengthen the target behavior. What must I

withhold or withdraw from a dog in order to encourage prior behavior? An unpleasant event. Therefore, to use negative reinforcement means to encourage a dog's behavior by removing or withholding from the animal something that it does not like. For instance, we can reinforce a dog for dropping a ball by releasing pressure exerted on his neck with a choke chain. Reward and omission DO NOT involve the use of force or discomfort to modify the dog's behavior. Negative reinforcement and punishment DO involve the use of force or discomfort to modify the dog's behavior.

<b>Table G1-1.--Nature of the Response Contingency</b>	
<b>INDUCIVE</b>	<b>COMPULSION</b>
POSITIVE (WITH) REINFORCEMENT Use of pleasant stimuli, such as food, toys, and petting	POSITIVE (WITH) PUNISHMENT Use of unpleasant stimuli, such as a collar correction
NEGATIVE (WITHOUT) PUNISHMENT Withholding or absence of pleasant events, such as food or praise	NEGATIVE (WITHOUT) REINFORCEMENT Reinforcement of behavior by withholding compulsion

e. Compulsive Training. "Compulsion" is a word that refers to forcing or coercing people or animals to do things. In compulsive dog training, the handler relies on unpleasant events to obtain desired behavior from the dog. Thus, compulsive training involves the use of negative reinforcement (encouraging desirable behavior by withdrawing or withholding unpleasant stimuli) and punishment (discouraging undesirable behavior by administering unpleasant stimuli). Although the training of working dogs often involves the use of some compulsive methods, it is important to understand that:

(1) These methods are effective and humane only under certain circumstances, when the dog is well-prepared and already understands the desired response and how to avoid compulsion.

(2) Excessive reliance on compulsion will damage the dog's rapport with his handler and cause it to dislike and avoid work.

(3) Compulsion may stimulate defensive and aggressive responses in the dog, and can in many circumstances be counterproductive and even dangerous for the handler.

24 FEB 2020

(4) Some phases of working dog training, most especially the detection phase, are incompatible with compulsive techniques.

f. Inducive Training. Inducive training is the opposite of compulsive training. The root word "induce" means to gently persuade. In inducive training the handler relies on the use of pleasant events and stimuli to obtain desirable behavior from the dog. Thus, inducive training involves the use of reward (encouraging desirable behavior by administering positive reinforcement) and omission (discouraging undesirable behavior by withholding or withdrawing positive reinforcement).

g. Primary and Secondary Reinforcement and Punishment. Many rewards and punishments are stimuli that are biologically powerful, such as food or pain. In the language of classical conditioning, they are called unconditioned stimuli (US's). In the language of instrumental conditioning, they are called primary reinforcers or primary punishers. Dogs respond readily and strongly to these stimuli without having to be taught to do so. However, some rewards and punishments are things, such as the words "GOOD!" and "NO!" that originally have little effect on a dog's behavior. These are called secondary reinforcers and punishers because they do not become effective until they have been associated with primary reinforcers or punishers.

(1) Secondary Reinforcers. Secondary reinforcers gain their pleasant value by being associated with primary reinforcers. For instance, puppies probably do not instinctively enjoy being spoken to. They learn to like being spoken to in a happy voice because this voice is associated (through classical conditioning) with physical petting and with the presentation of food. After enough of this conditioning, words like "GOOD!" spoken in a happy voice become pleasant stimuli. Subsequently, the word "GOOD!" has the power to reinforce prior behavior (if the handler says "GOOD!" immediately after the dog executes the behavior).

(2) Secondary Punishers. Secondary punishers gain their unpleasant value by being associated with primary punishers. For instance, the word "NO!" means nothing to an untrained dog. The word becomes unpleasant because it is associated (through classical conditioning) with unpleasant primary punishing events like a jerk on the collar. After enough of this conditioning, the command "NO!" spoken in a stern voice becomes an unpleasant stimulus. Subsequently, the word "NO!" has the power to punish

prior behavior (if the handler says "NO!" immediately after the dog executes the behavior).

5. Discriminative Stimuli. Thus far in our discussion of instrumental conditioning we have described only the contingent relationship between a target behavior and a reinforcer or a punisher (e.g., sit-food, or jump up- "NO!"). However, in order to behave appropriately in training, the dog must know *when* these contingent relations are actually in force. The handler will not reward a sit anytime the dog sits, but only when he/she desires the dog to sit. The way he/she signals to the dog that he/she wants it to sit is with the command "SIT!" This command tells the dog that now one or more response contingencies are in force. For instance, a prompt sit will result in petting and praise and the omission of a collar correction, while refusing to sit will result in no petting or praise and the administration of a collar correction. Thus, our full model for the use of instrumental conditioning can be symbolized as follows:

**Stimulus<sup>D</sup>Discriminative - Response - Consequence [or S<sup>D</sup>-R-C]**

S<sup>D</sup> is the command ("SIT!"), while R is the dog's response (sitting or refusing to do so), and C is the consequence of the dog's behavior (reward, negative reinforcement, punishment, or omission - food, petting and praise, collar corrections, etc.). This three-term model shows that the dog must actually learn at least two associations for any command skill—one between the behavior and the consequence, and one between the command and the behavior. In some types of animal training, these two associations are taught separately. For instance, first a killer whale is taught to jump for reinforcement, and then he/she is taught that the jump-reinforcement contingency is in force only after the trainer issues a command. If the whale jumps at any other time, no reinforcement will be forthcoming. However, in dog training both associations are normally taught simultaneously because the handler always includes the command in lessons (see tab G1, paragraph 7.).

6. Inducive Versus Compulsive Training. Some compulsion is normally necessary in working dog training, especially in the controlled aggression phase. However, inducive methods are to be preferred whenever practical. In particular, inducive methods are most advantageous for the initial teaching of any skill. That is, to an untrained dog the S<sup>D</sup>/command (e.g., "SIT!") means nothing. Therefore, if the handler gives the command "SIT!" and then administers a strong collar correction



24 FEB 2020

in the attempt to force the dog to sit, the dog will have no idea that it can avoid further unpleasantness by sitting. It will instead attempt to defend itself or avoid its handler. (More than anything else, such a method is a perfectly designed classical conditioning procedure that will condition fear and/or aggression to the command "SIT!" by pairing the command closely together in time with physical discomfort.) However, if we first teach the dog to sit on command using inductive methods, and ensure that it understands what sit means and that it has learned to enjoy training, then we may constructively use compulsion to hasten the dog's sit or to teach it to sit even in distracting circumstances. Thus, the proper role of inductive training is to teach the dog skills, while the proper role of compulsive training is to enforce the performance of these skills (if necessary). In addition, another very important role for inductive techniques is during the early stages of handling any dog, even a well-trained dog. The optimal way for a handler to build rapport and a good working relationship with a new dog is to perform inductive training exercises with the animal (e.g., food-rewarded sits), even if the dog already knows these exercises, and avoid the use of physical compulsion.

7. Application of Inductive Training. In inductive training, the handler employs gentle means to lead a dog to perform some target behavior, and then he/she reinforces this behavior. In the event that the dog does not execute the desired behavior, or executes it incorrectly, then the handler will omit reinforcement (negative punishment/omission, see tab G1, paragraph 4.f.(2)). In the classical example, the handler teaches a dog to sit by drawing the dog's attention to a piece of food in his/her hand. Once the dog places its muzzle in contact with the handler's fist in the attempt to take the food, the handler then slowly raises his/her hand and moves it slightly backwards towards the dog's tail, simultaneously giving the command "SIT!" In following the movement with its head, the dog is very likely to sit. The handler then opens his/her hand to feed the dog and administers praise. If the dog fails to sit, the handler withholds reinforcement and praise (omission) and continues attempting to "finesse" the sit. In such a stress-free setting, a dog can learn very rapidly to sit on command. In addition, it also learns to enjoy work, and it develops affection and trust for its handler. There are similar methods for teaching almost all of the exercises of obedience.

a. Successive Approximation and Shaping. Successive approximation is a practice in which animals are taught behaviors by rewarding responses that are progressively more and

24 FEB 2020

more like the desired target response. For instance, to teach a dog to sit through successive approximation, a handler would wait until he/she observed a tiny approximation of a sit on the dog's part, such as flexing of the hind legs, and then reinforce this movement. Once the dog was flexing its legs readily for reinforcement, then the handler would withhold reinforcement until the animal exhibited a flexing that was slightly greater than before, that approximated a little more closely an actual sit, and then he/she would reward this behavior, and so on. The entire process of extracting a trained response through successive approximation is called behavior shaping. Successive approximation and shaping are of vital importance in the training of exotic animals such as killer whales and sea lions, but they play comparatively little role in dog training, for the simple reason that a good dog trainer can usually think of a way to get the dog to offer the complete behavior, and then reward that, as described in relation to the sit in tab G1, paragraph 7. However, particularly in the case of very complex or difficult behaviors, or behaviors for which the dog is handicapped or contra-prepared (i.e., when a dog has a history of problems with a particular exercise), it is very important to realize that often a good handler will reinforce his/her dog for a good "effort" in the direction of the desired target behavior. This will encourage the animal and lead it to continue trying to learn the lesson.

b. Reward Schedules. A reward schedule is a rule that dictates how often a dog will receive positive reinforcement when it correctly executes a skill. It is very important to understand these schedules, because they produce different effects and are appropriate at different stages of the training of each skill. There are six types of reward schedule we should consider:

(1) Extinction Schedule. To extinguish an instrumental response we merely allow the behavior to occur again and again, without rewarding it. The behavior will gradually decrease in strength and frequency until it disappears. Thus, to extinguish an undesirable behavior like jumping-up, it is often sufficient to identify the reward for the behavior (it is usually some reaction given by the handler when the dog jumps up) and then make sure that this reward never follows the problem behavior. This is called "putting jumping-up on an extinction schedule." It is important to realize that some behaviors are "intrinsically" reinforcing; that is, just doing them is rewarding to the dog. If a behavior is intrinsically reinforcing, it will not extinguish even though we put it on an

extinction schedule. Thus, if an anxious dog finds a way to release tension by barking in its kennel, it may not ever stop barking in the kennel, even if its handler is careful to never go to it when it is barking.

(2) Continuous Reward Schedule (CRS). Positive reinforcement is given immediately when the dog makes a correct (or sometimes a near-correct) response. Assisting the dog to assume the desired position or behavior is permissible (i.e., in the case of the sit, gentle pressure on the rump to encourage the animal to sit), but it is preferable to "finesse" the dog into the sit by baiting it with food or some similar technique. Inducing the animal to perform the desired behavior independently and then reinforcing the behavior will produce more rapid learning than "pushing" the animal into position and then rewarding it for allowing this to happen. CRS is the most effective reinforcement schedule for teaching a dog a skill.

(3) Fixed Ratio Reward Schedule (FRRS). Positive reinforcement is given to the dog after it makes two or more correct responses. It is most useful to think in terms of ratio schedules of reinforcement in the case of behaviors that are "episodic" like barks and scratches. To start a dog on the FRRS schedule, every second response is rewarded. When the dog consistently makes two responses to obtain a reward, require three responses. By increasing the number of responses, one at a time, and allowing the dog to perform at each level with 100% proficiency, you can work up to a high FRRS. If the proficiency falls below 100%, then decrease the number of responses required to obtain a reward until the dog recovers its proficiency. Then proceed as before, adding one response at a time. A fixed ratio reward schedule is the way that a handler can best train his/her dog to, for instance, bark or scratch repeatedly at a door to indicate the presence of an agitator in a building. Initially, while we are trying to teach the behavior, the handler will open the door and allow the dog to bite (reward) after one bark or scratch, then he/she will require two barks or scratches before rewarding the dog, then three, and so forth.

(4) Variable Ratio Reward Schedule (VRRS). Once the dog has learned to perform the maximum number of responses by this FRRS schedule, then use the VRRS. Select a range of responses (e.g., five to ten correct responses) required and reward the dog on a random basis within this range (e.g., the dog has already learned to bark fifteen times in order to obtain a bite on an FRRS). Now you should begin rewarding the animal somewhere between five and ten barks, on a random basis, so that

24 FEB 2020

the dog never knows whether it will have to bark five, six, seven, eight, nine, or ten times in order to get a bite. The dog will learn that it must correctly respond at least five times, and perhaps up to ten times in order to obtain a desired reward.

(5) Fixed Interval Reward Schedule (FIRS). Reinforcement is given to the dog after he/she responds to a command for a given fixed period of time. It is most useful to think in terms of interval schedules of reinforcement in the case of behaviors that are "continuous," such as staying in position, heeling, and searching. In initial training, select a short period. If the dog does not respond correctly, select a shorter period of time until the dog responds correctly to obtain a reward. As in the FRRS, add short periods of time (e.g., five seconds) to the interval and require the dog to attain 100% proficiency at each interval. If the dog fails to respond correctly for the required period of time, readjust the time requirement to a lower time requirement until the animal regains 100% accuracy, and then begin gradually again to increase the required interval. Excellent examples are staying in a position (like the down) and walking at heel. In each of these cases, a good trainer initially rewards the dog for just a few moments of good responding. With time and practice the handler gradually extends the period of time that the dog must remain in the down, or walk at his/her handler's side. Gradual extension of the period of time a dog works before reinforcement plays a vitally important role in detection training. A good trainer arranges a search problem for a novice dog so that it can easily find the target odor and obtain reward in perhaps less than a minute, whereas he/she requires an advanced dog to work for five or ten minutes or more prior to finding the target odor.

(6) Variable Interval Reward Schedule (VIRS). Once the dog has learned to perform a task for a period of time on a FIRS, use the VIRS. Select a time range (e.g., one to two minutes) and reward the dog on a random basis within this time period. For example, if the dog has already learned to hold a down-stay for three minutes on a FIRS, then begin rewarding it somewhere between one and two minutes on a random basis. The dog will learn that it must hold the down for at least one minute and perhaps for up to two minutes in order to obtain reward.

(7) Application of Reward Schedules. Normally, in dog training it is not necessary to exactly follow the above steps to get good results. It is usually sufficient to follow these

24 FEB 2020

general rules: When teaching a dog to give an episodic response (e.g., bark) begin by rewarding it every time it barks (CRS), then reward it gradually for longer and longer sequences of barking, working your way up to the maximum number of barks that will be useful (FRRS). At any point that the dog shows hesitation or confusion, decrease the number of barks required so that the animal regains proficiency and then begin working back up again. Once the dog barks rapidly and confidently about the maximum number of times desired in order to obtain its reward, then begin giving it rewards randomly for some number of barks less than the maximum (VRRS). When teaching a dog to perform a continuous response (e.g., holding a down-stay), establish performance by rewarding it consistently after a very short period of time (FIRS). Then begin gradually extending the period of time that you require the dog to stay. Do not hesitate to decrease the duration requirement if the dog's performance deteriorates. Once the dog stays solidly for about the maximum desired period of time, then begin rewarding it randomly for stays of various durations less than the maximum (VIRS).

(8) Advantage of Variable Reward Schedules. You may ask "Why bother to use VRRS and VIRS schedules?" Using FRRS and FIRS the animal has already learned to bark many times in succession or stay for several minutes. The reason is that variable schedules teach the dog to be persistent and stubborn in trying to obtain its reward through instrumental behavior. Many scientific studies have shown that variable reward schedules produce stronger and more persistent conditioned behavior than fixed schedules. The psychological basis of this persistence effect is well understood, but it is very complicated. So a good simple way to think of the variable reinforcement phenomenon is this: when the dog never knows how many times or how long it will be required to perform before being rewarded, it "loses track" of how many and how long and just concentrates on performing persistently for reward, convinced that if it tries hard enough it will eventually get what it wants.

8. Application of Compulsive Training. Just as it is important to understand certain basic principles (such as reward schedules) in order to perform effective inductive training, it is also important to understand certain basic principles in order to use compulsive training effectively.

a. Use of Positive Punishment. Positive punishment is used to teach a dog not to do something. Of course, this doesn't

24 FEB 2020

mean that the dog should do nothing, but that it should do something else, such as sit still. There are three major principles the trainer must understand in order to use punishment effectively and humanely:

(1) The dog must have the ability to perform the alternative behavior. For instance, if a dog is breaking the down-stay because it is frightened of a jet engine, the dog's fear may render it unable to do what is necessary to avoid punishment. That is, if a trainer physically punishes a frightened dog for not staying, the punishment is likely to make the dog even more afraid and less capable of staying. This is not fair nor humane nor effective dog training.

(2) Do Not "Ramp Up" Corrections. That is, do not begin punishment by using a very soft correction, and then gradually increase it as needed. Dogs, especially very excited dogs intent on working their way to a reward, adapt quickly to physical punishment and can learn in a short period of time to endure very uncomfortable events without altering their behavior. It is possible to, without meaning, create a "monster," a highly excited and stressed animal that can absorb enormous amounts of physical discomfort without changing its behavior into the desired path. Instead, begin punishment training with a correction of an intensity that is meaningful to that dog and sufficient to cause it to change its behavior immediately.

(3) Do not use punishment if it is not working. That is, if you have tried to intervene with a problem behavior by using what you believe is a meaningful intensity of punishment for that dog, and the desired result is not achieved, think carefully before you apply stronger physical punishment. The dog may be, for any number of reasons, incapable of the alternative behavior. He/she may have a history of bad training that has rendered humane and reasonable levels of physical punishment ineffective. You may be making some errors in technique that are preventing a humane and reasonable level of punishment from having the desired effect. In any of these cases, it is inexcusable to continue to physically punish a dog.

(4) Avoid Emotion When Administering Punishment. If you are angry, or frustrated, or upset while administering punishment to a dog, you can be virtually certain that you are making mistakes and being unfair to the dog. Revenge and temper tantrums have absolutely no place in working dog training; you

must not let training turn into a spectacle of one dumb animal hurting another.

b. Use of Negative Reinforcement. Negative reinforcement is the reinforcing of behavior by withholding compulsion. The classic example in military working dog training is the "OUT," in which the dog releases an agitator on command. Although a clever handler uses whatever positive reinforcement he/she can to reward the dog for releasing cleanly (e.g., praise, immediate re-bite), the "OUT" is normally taught and maintained principally through the administration of negative reinforcement. Thus, if the dog releases cleanly on command, he will NOT be corrected with a jerk or pull on the choke collar. All of the principles stated above that apply to positive punishment apply to negative reinforcement as well. In addition, it is also vital to understand the following terms and definitions:

(1) Escape Training. Escape is an initial stage of negative reinforcement training. During this stage, the command "OUT!" is meaningless. The dog does not yet understand that the command "OUT!" means that if it does not release it will receive a collar correction. On the first trial, when the handler gives the "OUT!" command and the dog continues biting, the handler then applies a collar correction until the dog releases the bite, praising the dog once it has released. In all likelihood one or several more trials will proceed much the same. Although the dog may not be releasing on command, it is learning all the same. During this stage the dog learns to expect the correction when it hears the command "OUT!," and it also learns to "turn off" or terminate the correction once it is applied by releasing the bite. This escape learning is very important. A dog that does not know precisely how it can "turn off" compulsion will be stressed and upset by corrections, and may engage in inappropriate behaviors to try and terminate discomfort, such as biting its handler. This point is especially important when the escape behavior, the behavior that we desire to teach the dog, involves a complex response like walking at heel or recalling to heel. If these exercises are taught using negative reinforcement, there must necessarily be a stage during which the handler teaches the dog to terminate collar corrections by placing itself at heel. If the animal does not know how to terminate compulsion by placing itself at heel, then collar corrections will only make it move more and more strongly away from its handler. In fact, this is why it is so important to patiently teach the dog as many skills as possible by means of positive reinforcement prior to polishing any of them with

negative reinforcement, to make sure that the dog knows how to perform all behaviors on command. In this way the dog is well prepared to learn very quickly, with minimal stress or confusion, how to terminate compulsion by executing a commanded behavior.

(2) Avoidance Training. Avoidance is the next stage of negative reinforcement training, during which the dog learns that, in addition to terminating compulsion by releasing the bite, it can also completely avoid compulsion. That is, if the dog releases the bite quickly on command, the collar correction will never occur. When avoidance is completely and cleanly taught, every time the dog releases on command, he/she is reinforced by the absence of the correction, as though he/she "beat the rap." Note that sometimes the dog, especially if it has prior experience with the "OUT!" command, will go directly to avoidance (releasing on command) after only one correction, without a noticeable escape stage of learning.

(3) Criterion Avoidance. The end goal of negative reinforcement training is to secure correct response to the command every time, without the need to use compulsion to "escape" the dog into the desired behavior. In working dog training, this goal has the additional dimension that the handler also is training towards the point at which he/she can discard the means of compulsion (i.e., collar and leash). That is, a dog that is fully-trained to "OUT" not only releases cleanly on command, it also releases when the collar is not attached to the leash, and when the handler is 20 or 30 yards away. In these cases, the handler has given up his/her option to correct the dog effectively. If the animal fails to obey the command, the handler has no good options. This means that the handler must not discard the means of compulsion until the dog has achieved a good avoidance criterion, clean avoidance of compulsion by good response to command consistently and repeatedly over at least four to five training sessions. During these error-free training sessions the handler stands ready to correct the dog instantly, with all necessary things in place, but does not ever need to. On the other hand, if the dog still occasionally fails to respond correctly, "testing" to see if the handler is ready to apply the correction, then the dog has not yet achieved criterion avoidance and it is not yet ready to proceed further in training. The animal must continue to practice, with the handler standing by, ready to enforce obedience, until criterion avoidance is obtained.



24 FEB 2020

(4) Supporting Negative Reinforcement with Positive Reinforcement. Although behavior learned through negative reinforcement training can be very durable and reliable, it is advisable to, whenever possible, support negative reinforcement with positive reinforcement. Give the dog rewards in addition to the reinforcement of not being corrected. For instance, after a clean, fast out from the agitator, you might praise your dog quickly and then immediately let it re-bite and take the sleeve away from the agitator. After the last out of the training session, after the agitator runs away, you can reward your dog for his good compliance by letting him bite and carry a section of rubber hose or some other toy.

## 9. Generalization of Classical and Instrumental Conditioning

a. Generalization. Generalization is a process in which behavior that is learned in response to one stimulus is expressed to some degree in response to another stimulus. Generalization takes place with both classically-conditioned and instrumentally-conditioned behaviors, and the more similarity there is between two stimuli, the more generalization there will be from one to the other. Thus, a dog that has learned a strong startle response to the "NO!" command may also startle and return to its handler when he/she says "Yo!" loudly to a friend. A dog that has learned to sit in response to one explosive odor, such as ammonia dynamite, may also sit in response to a similar non-explosive odor, such as ammonia-based house-cleaning liquids. These are both examples of undesirable generalization, but generalization may also work in our favor. For instance, if you are incapacitated during a patrol deployment, but your well-trained dog also releases the bite in response to your partner's "OUT" command that is desirable generalization.

b. Context Generalization. Trained behaviors are not just controlled by CSs (classical) and S<sup>D</sup>'s (instrumental). To some extent, they are also controlled by context. Context is the word psychologist's use to label all of the stimuli present in the conditioning situation other than the CSs and US's, the S<sup>D</sup>'s and consequences. Context means the "environment." Context definitely participates in learning, and generalization from one context to another is rarely perfect. As a result, a dog that has learned to search and detect in a warehouse may also do so when it is taken to an office building, but its search and/or detection behavior is liable to be substantially different in the office building. To a degree, much of dog training consists of teaching dog's skills, and then trying to make these trained behaviors as independent as possible of the context, so that the

dog will perform correctly anytime and anywhere. The best way to make trained behavior independent of the context is to train in as many different places and situations as possible (after the initial learning phase).

10. Learning Transfer. Transfer of learning is what takes place when the learning of one skill or command affects the learning of another skill or command. Transfer can be positive (favorable) or negative (unfavorable).

a. Positive Transfer. In positive transfer of learning, the fact that the dog has already learned to do one thing actually helps it to learn to do another. Thus, learning to sit in response to the "SIT!" command during obedience training transfers positively to detection training, helping the dog to learn to sit in response to odor. In fact, one of the main ingredients to good dog training is teaching each skill at such a time and in such a way that it helps the dog learn the next skill.

b. Negative Transfer. In negative transfer of learning, the fact that the dog has already learned to do one thing hinders it when it is trying to learn another. For instance, if your dog has already learned to scratch at a door in order to get through it and reach an agitator, this may transfer negatively to explosives detection training, making it more likely to "aggress" a training aid rather than sit cleanly.

11. Anticipation. As a result of classical and instrumental conditioning, the dog learns to predict what will happen next during training. This knowledge of what is about to happen is accompanied by psychological and physiological changes that prepare the dog for upcoming action. Much the same thing happens to you when, riding in a car, you see the car ahead lock up its brakes. As a result of your anticipation of a collision, you brace yourself. The dog's anticipation of the events in dog training and its preparatory responses can help it learn. For instance, if your dog is having difficulty responding without assistance to odor during detection training, it sometimes helps to allow the animal to find a particular training aid two or three times running. Because the dog anticipates finding the same aid in the same place and sitting, he/she will be likely to respond quickly and completely without an assist, giving you the chance to reinforce this independent behavior. On the other hand, there are many circumstances in which anticipation can interfere with learning desired behavior. For instance, during the obedience exercises at the End Of the Leash (EOL), the dog

24 FEB 2020

is normally commanded to change position a few times (e.g., sit-down-sit) without moving towards the handler, and then recalled to the heel position and rewarded. However, if we practice this complete sequence of exercises many times, we may find the dog's knowledge of the routine interfering with the changes of position. The animal's anticipation of returning to the handler and being rewarded will cause it to creep forward instead of staying in place while moving from sit to down and back to sit. Controlled aggression is a situation where anticipations can be particularly crippling to progress. When in the intensely motivated state that pertains during controlled aggression, the dogs' anticipations have tremendous power, and can create intense interference with ongoing exercises. So, for instance, if you have brought your dog to the line of departure for the biting exercises, it will tend to become very excited and tense and focus its attention completely on the agitator, ready to respond explosively to the first cue sending it to bite. Its powerful anticipation of the bite and its preparatory responses will make it very difficult to, for instance, ask it to pay attention to you and walk at heel away from the agitator. It is inappropriate and ineffective in many of these circumstances to use compulsion to overcome the dog's anticipation and rigidity. Physical discomfort is likely to make the dog even more tense and rigid and aggressive. What is necessary is to find ways to offset the dog's anticipations so that they do not interfere so strongly with training. For instance, begin teaching the animal that the command to bite will often come when it looks at its handler or walks at heel with its handler away from the agitator. When this anticipation is formed, the dog will naturally begin to "ask" for the "GIT 'EM!" command by looking at and moving towards its handler.

12. Compartmentalization. The single most useful technique for dealing with anticipation and interference is to separate, or compartmentalize, exercises that interfere with each other. Thus, in the EOL example above, the thoughtful trainer will seldom recall his/her dog from EOL. Instead, the trainer will place the animal EOL, run it through a few changes of position, pause, and then go to the dog and release it and reward it. In this way, the dog does not anticipate a recall at the end of the EOL exercises and, therefore, does not creep forward. To practice the recall from EOL, on a separate occasion the trainer will place the dog EOL and make it stay for a while, and then recall it. In this way, the changes of position and the recall are compartmentalized and prevent interference.

**TAB G2**

Clear Signals Training Method

**Table of Contents**

<u>IDENTIFICATION</u>	<u>TITLE</u>	<u>PAGE</u>
<b>PARAGRAPH</b>		
1	Introduction.....	G2-1
2	Clear Signals Training Method.....	G2-1
3	Obedience training with CST.....	G2-16
4	Controlled Aggression Training with Clear Signals Training.....	G2-30
<b>TABLES</b>		
G2-1	Teaching, Training, and Proofing Phases of Various MWD Skills.....	G2-5

1. Introduction. Dog training methodology is not static. Instead, as a result of new insights and new information, dog training methods evolve, becoming more effective and more powerful. This section is meant to provide a brief review of new techniques that are available for training MWDs for obedience and controlled aggression. These techniques are currently used at the 341 TRS, JBSA-Lackland.

2. Clear Signals Training Method. In the last ten years, enormous technical progress has been made in the methods used to train working dogs for obedience and controlled aggression. The most important advances were made by amateur trainers who compete in obedience competition. The method developed for use by the DoD MWD Program is called Clear Signals Training (CST).

- a. CST is founded on three very important ideas:
- Teach skills with rewards, not physical force;
  - Establish clear communication;
  - Use compulsion only when necessary, and use it in a fair and effective fashion.

(1) Teach Skills With Rewards, Not Physical Force. As much as possible, MWDs should be taught and motivated to work using rewards to induce desired behavior, rather than using force to compel the dog to do as the trainer wants (see tab G1, paragraph 6 for discussions of inductive versus compulsive training methods).

24 FEB 2020

(2) Establish Clear Communication. One of the most critical aspects of dog training is the development of clear communication between handler and dog, so that the dog knows what the trainer wants, and it fully understands the relationships between its behavior and various consequences.

(a) CST makes sure the dog understands what the trainer wants by breaking training into stages, the first of which is a *teaching phase* in which the dog performs for rewards in a very low-stress atmosphere.

(b) CST makes sure that the dog understands the relationships between its behavior and specific consequences (the response contingencies, see tab G1, paragraph 4.6) by using conditioned signals or "markers" (the words "YES", "GOOD," and "NO") to help the dog realize exactly which of its behaviors resulted in a particular reward or a particular punishment. This approach has only recently become established in the working dog world, but for many years it has been extremely influential in the training of exotic animals like killer whales and big cats. In more recent years the response marking approach has also influenced trainers that work with dogs assisting deaf persons, and otherwise disadvantaged populations. When combined with the use of positive reinforcement techniques, response-marking methods are the most powerful available technology for shaping behaviors, and they should become a basic part of the DoD MWD Program skill set.

(c) Use compulsion only when necessary, and use it in a fair and effective fashion. CST assumes for the dog trainer to use physical force or compulsion (see tab G1, paragraph 6) in a way that is effective and fair, the dog must first pass through two stages of learning. It must first be taught the skill (e.g., sitting or lying down), so that it understands what is required before it is subjected to any physical or psychological pressure. Then the dog must also go through another stage in which it is taught about the correction that will be used to apply the pressure (e.g., the jerk on the choke collar). In this stage the dog learns that it can terminate the correction by using a certain behavior, and it learns not to fear the correction (here we are discussing a very gentle version of escape learning). Only when the dog understands the skill and understands the correction and how to respond to it is it fair and effective for the handler to apply strong pressure (to generate avoidance learning).

b. Teach, Train, and Proof

24 FEB 2020

(1) CST breaks MWD training into a three-stage process. Each skill is first taught, then trained, and then proofed. Not all skills that we teach working dogs participate in all three of these phases, but many of them do, especially obedience skills like "SIT," "DOWN," and "HEEL".

(2) Teach. The initial stage is called *teaching*. During this stage the dog learns what is expected of it in a given situation. As a rule, teaching proceeds best when the dog works for a reward like food or a ball/kong, and is not stressed or anxious. Earlier we described this kind of training as "inductive," and pointed out that the two inductive tools available are positive reinforcement and negative punishment (also called omission). During *teaching* we concentrate on motivating and teaching the dog in a low-stress atmosphere, giving it rewards when it performs correctly (positive reinforcement) and withholding rewards (negative punishment) when it makes mistakes.

(a) For example, we teach the dog to sit by holding food over its head. In the effort to reach the food, the dog lifts its head and rocks backward, accidentally assuming the sit position, and then we reward this action by allowing the dog to have the food.

(b) For example, we teach the dog to maintain eye contact with the trainer by making a noise so that the dog looks at the trainer's face, and then we allow the dog to have the ball or kong.

(c) During teaching we avoid the use of any physical force or input designed to compel the dog to perform a specific behavior. Instead the dog is given the freedom to experiment with its own behavior and learn what responses bring reward and which responses do not bring reward. Errors are seen as desirable because it is by making mistakes that the dog sharpens its understanding of "correct" behavior.

(d) During initial teaching we normally rely on continuous reinforcement in which we reward every correct repetition of the exercise.

(e) Teaching normally involves the use of obvious gestures and body language cues that the trainer uses to lure the dog into position with the reward: moving the hand upwards for the sit, bending at the waist and placing the hand on the

24 FEB 2020

ground for the down, etc. These gestures are called "prompts," and with further training they are normally faded out.

(3) Train. The next phase of CST is called training. During the training phase we take the practiced skill that the dog has learned to use to obtain reward and we put it under the influence of some form of physical "correction." In dog training, it is very common to use the term "correction" for physical inputs that are meant to pressure the dog into certain actions. Thus "correction" refers to the other two response contingencies described earlier, negative reinforcement and positive punishment. This does not mean that during training we use heavy psychological and physical pressure on the dog. Far to the contrary, during training our main objective is to keep the dog comfortable and positively motivated, while showing it the "meaning" of each specific correction, teaching the animal that it has the power to control this correction, and teaching it how we wish it to behave under the correction.

(a) For example, we train the dog to associate a tug on the leash/choke collar with sitting by asking the dog to sit in the presence of food, much like before, but after we give the "SIT" command we give a soft correction on the collar by "popping" the leash. The pop does not make the dog execute the sit; the animal is already sitting because of habit and its desire for reward. The pop does not hurt the dog. The procedure "connects" the correction to the sit; it puts the sit skill under the control of the collar correction.

(b) For example, we train the dog to maintain eye contact (attention) by bringing the dog "into focus" on the handler, and keeping it there for a moment. An assistant provides a soft distraction like tapping a foot so that the dog looks away from the handler for an instant. At that moment the handler says the dog's name and an instant later gives a soft pop on the leash/collar. The pop does not make the dog look back at the handler. The dog looks back simply because it hears its name and it wants reward. But the procedure connects the "pop" to attention so that the dog's attention comes under the control of the leash correction.

(4) Proof

(a) The last phase of CST training is called proofing. During proofing the handler reduces the frequency of reinforcement (moving into intermittent and random reinforcement schedules), begins to fade out gestures (prompts) that have been

24 FEB 2020

used to assist the dog to execute skills, and begins asking the dog to perform the skills in different, distracting environments. As a result of these changes, the dog's performance is disrupted. To put it another way, the animal makes mistakes, and these mistakes may be corrected (to generate avoidance learning).

(b) Corrections administered during proofing of a particular skill, like sitting under distraction or holding the down-stay, must be "fair." Another way to say that a correction is "fair" is to say that it is effective and the dog learns very quickly to avoid any future corrections. Providing that we have done a good job of teaching and training a skill, proofing of that skill normally proceeds efficiently (i.e., results in avoidance responding), and without any particular upset or stress on the dog's part [see table G2-1].

<b>Table G2-1.--Teaching, Training, and Proofing Phases of Various MWD Skills</b>			
	<b>Teaching Phase</b>	<b>Training Phase</b>	<b>Proofing Phase</b>
<b>Skill</b>	Dog learns to perform a skill for reward; errors are permitted and even encouraged so that the dog learns which behaviors are successful and which behaviors are errors.	Dog learns that the skill terminates or "turns off" a gentle correction, and that an error (such as breaking attention or breaking the sit-stay) "turns back on" the correction. See escape learning.	Dog learns that, even though the skill still earns reward, this reward is less frequent, and the skill is mandatory. Refusal and errors "turn on" sharp corrections, and compliance to first command avoids corrections altogether. See avoidance learning.



<b>Table G2-1.--Teaching, Training, and Proofing Phases of Various MWD Skills</b>			
	<b>Teaching Phase</b>	<b>Training Phase</b>	<b>Proofing Phase</b>
<b>Attention</b>	Teach dog to look at the handler on cue (usually the dog's name) for food, then transition to ball/kong reward.	Train dog to "turn off" mild collar corrections by looking at handler on cue, or by continuing to look at the handler.	On first command, dog must pay attention to the handler, and maintain this attention despite distractions, in order to avoid sharp collar correction. Initially dog given food, ball/kong frequently to reduce stress; later these primary rewards to some extent "weaned out."
<b>Down</b>	Teach dog how to lie down for food, then transition to ball/kong reward.	Train dog to "turn off" mild collar correction and "social correction" (see tab G2, paragraph 2.f(3)(c)) by lying down, or by holding the down.	On first command, dog must lie down quickly and hold the down, in order to avoid a sharp collar correction or strong social correction (see tab G2, paragraph 2.f(3)(c)). Initially dog given food, ball/kong frequently to reduce stress; later these primary rewards to some extent "weaned out."
<b>Heel</b>	Teach dog to move to heel position for food, then transition to ball/kong reward.	Train dog to "turn off" mild collar corrections by moving to heel position or by staying at heel and in attention.	On first command, dog must move to heel position, establish attention (looking at handler's face), and maintain heel position and attention, in order to avoid sharp collar correction. Initially dog given food, ball/kong frequently to reduce stress; later these primary rewards to some extent "weaned out."

<b>Table G2-1.--Teaching, Training, and Proofing Phases of Various MWD Skills</b>			
	<b>Teaching Phase</b>	<b>Training Phase</b>	<b>Proofing Phase</b>
<b>Out</b>	Teach dog to release grip on "dead" object to earn another bite and "fight". Not always practical. Normally begun using a less motivating object such as PVC pipe.	Train dog to "turn off" collar corrections by releasing bite. If necessary dog forced to release with collar correction. Performed with more motivating bite object like rubber hose or jute tug toy.	Dog must release bite immediately on first command in order to avoid sharp collar correction. Performed on decoy with bite sleeve, suit, etc.
<b>Stand-Off</b>	Teach dog to earn bite by lying down on command- Decoy comes to the dog to give reward (see tab G2, paragraph 4.e(8)(a)1).	Train dog to "turn off" mild collar corrections by stopping forward movement, and then lying down.	Dog must stop forward movement on command in order to avoid sharp correction (down maintained by positive reinforcement); i.e., once dog stops moving forward, tends to lie down voluntarily to earn bite.
<b>Odor Recognition</b>	Teach dog that target odor is associated with ball/kong.		
<b>Final Response</b>	Teach dog to sit in order to gain access to a blocked ball/kong ("blocked" = held in hands, wedged between furniture and wall, etc.).	Sit in response to odor supported by the use of mild cues (pressure on rump, mild pops on collar) that are "turned off" by the sit.	

c. The "Escape Training" Method

(1) We should compare CST to more traditional methods in which the dog is not taught skills inducively, but instead has to learn what is expected under physical force. In this situation, because the skills are associated from the beginning of training with psychological pressure and discomfort, the dog learns to dislike its work and to resist the trainer, which makes the animal difficult to train. More importantly, the dog also becomes defensive. What we mean by defensive is this:

When we expose an animal time and again to something unpleasant like a jarring collar correction, or choking with a chain collar, and we have not previously taught the animal how to understand this correction, then the first thing that the animal begins to do when it anticipates a correction (e.g., when it hears the "SIT" command) is protect/defend itself by stiffening its neck and bracing its legs. Obviously a dog that is physically stiff and tense has great difficulty sitting quickly (or doing anything quickly), so the dog tends to make more mistakes, and receive more corrections; which makes the animal even more stiff and tense, and so on. For these reasons, traditional "escape" methods for obedience and patrol tend to generate very high levels of resistance, fear, and confusion on dogs' part.

(2) In contrast, CST is directed at preventing fear and confusion by first teaching the dog exactly what to do on command to get a reward (**teaching**), then teaching it how to use this action to "turn off" a correction (**training**), and finally showing it that sometimes it has no choice but to do what its handler commands (**proofing**). When training is approached this way, even if the trainer finds it necessary to apply physical force to the dog, the animal is not excessively frightened or stressed; because it knows what to do and how to control the correction it receives, it responds quickly to terminate the correction, and then in future behaves so as to avoid the correction completely.

d. The "Clear Signals" Part of CST. The division of MWD training into **teaching**, **training**, and **proofing** phases is a new idea in the DoD MWD Program, but it is not cutting-edge theory. Teach-train-proof is a version of what the best dog trainers have been doing for decades now. But the next part of CST is more revolutionary, it involves the use of conditioned cues to communicate with the dog to give it very precise information about the relationship between its behavior and rewards and punishments. These conditioned cues are called "markers," and often "bridges," because they perform two very important functions, **marking** responses for reward or correction, and **bridging delays** to reward or correction.

(1) Response (or Behavior) Marking. Most skills in dog training feature a critical aspect, a point in the course of the skill when the trainer's requirement is fully met. This can be the moment the dog locks its eyes on its handler's in response to the "look" command for attention, or the moment the dog's elbows touch the ground in response to the "DOWN" command. If

we can make the dog understand that it is these critical aspects, these core requirements of the skill, that earn reward, then we can become very effective trainers.

(a) In traditional training we try to make the dog understand by following the old rule "in order for the dog to understand why it is being rewarded or corrected, reward and correction must follow immediately after the desired behavior." The problem is that in many situations it is very difficult to reward a desired behavior without accidentally rewarding some behavior that comes after the desired behavior. To choose just one of very many examples, if I am teaching my dog to march/heel while maintaining attention on my face, and I start to reward this behavior with the kong in my right pocket, when the dog sees me move my hand towards my right pocket it looks at my hand instead of my face, and often it crosses in front of me to follow the hand to where it knows the reward is. Therefore, when I produce the ball and give it to the dog, I am not rewarding the behavior I want (clean heeling at the left side with eye contact), but other behaviors (looking at my right hand, forging ahead, crossing in front, and interfering with my movement) which are detrimental to my goal.

(b) The "YES" Release Marker. The use of a marker solves this problem for us. The marker we most commonly use is the word "YES" said in a distinctive way. In order to use the "YES" we must first condition it, turn it into a secondary reinforcer by pairing it with the reward (see classical or Pavlovian conditioning and secondary reinforcers). Most often we use "YES" with ball reward. We can condition the marker by saying "YES" and then giving the dog the ball about a dozen times, with about ½ to one second between "YES" and the ball. Once the "YES" marker is conditioned, then it has gained the power to act as a reward. The word has become significant, and when I say "YES" immediately after some behavior on the dog's part, the dog "notices" what it has done, the behavior is marked.

1. In order to produce rapid learning of the desired behavior, you need to let the dog have the primary reinforcer, the ball. And here is the advantage to using the "YES". Because I have marked the desired behavior with the word "YES", I am no longer under pressure to get the reward to the dog quickly, and I do not need to worry about any behaviors the dog engages in between the behavior I want to reward and when the dog actually receives the ball. The "YES" marker does three critical things for the trainer.

a. "YES" marks a specific desired behavior (e.g., making eye contact while moving in heel position).

b. "YES" releases the dog from the behavior; when the dog hears "YES" it knows it's finished with its job.

c. "YES" bridges the delay to reinforcement (hence the term bridge, often used interchangeably with marker). Even though it may take me ten seconds to get the ball out of my pocket and give it to the dog, and the whole time the dog is dancing around me and jumping up and down in anticipation of getting its reward, when the dog actually gets the ball it will associate this reward with what it was doing right before it heard "YES" instead of what it was doing right before it got the ball.

2. Because the dog can release after hearing "YES," because the job is ended when the "YES" is given, this cue is called a "terminal marker." Saying "YES" is just like saying "OK", in that the dog can do anything it wants after it hears "YES".

(c) The "GOOD" Marker

1. However, sometimes we don't want to release the dog, we want to encourage it, but keep it performing. In this case we need a different kind of marker. Because the skill is not done when we use this marker, it is called an intermediate marker (as opposed to the terminal marker, "YES"). In CST the intermediate bridge is usually the word "GOOD," said in a distinctive and encouraging voice.

2. The sequence runs like this: while the dog is performing the skill it receives one or two "GOOD" markers at critical moments, then when it has finished the skill to the trainer's satisfaction it receives the "YES," and then the primary reward. Because the dog hears "GOOD" before receiving the "YES" cue and then receiving the reward, after a number of repetitions the "GOOD" also becomes associated with reward (this is called second-order conditioning) and "GOOD" also takes on the power to reinforce and mark behaviors.

(d) The Two Methods of Marking and Rewarding Behavior. We have now described two different ways of rewarding the dog with markers, "YES"-release, and "GOOD"-marker followed by "YES"-release.

1. "YES"-Release. When the dog has completed the skill the trainer rewards it with the "YES" cue. On hearing "YES" the dog breaks from position, and the trainer provides the primary reward. Yes-marking is used to teach the dog to respond swiftly to commands.

2. "GOOD"-Marker Followed By "YES"-Release

a. When the dog is doing well, the trainer encourages it with the "GOOD" cue, the dog continues to perform, and then when the skill is complete, the handler releases with "YES," and then provides the primary reward. "GOOD"-marker then "YES"-release is used to encourage the dog and keep it performing.

b. Reward in Position. A special kind of "GOOD"-marker followed by "YES"-release is used to stabilize the dog into certain positions, such as the sit and down at the end of the leash, sit at heel position, and the field interview. These skills are all characterized by one problem. The dog is supposed to stay in a particular place and position, but it will be rewarded from another location. For instance, after sit and down EOL, the dog is recalled to heel and then released and rewarded. Because the dog anticipates this reward, it begins to creep forward towards the handler while moving from down to sit or vice-versa, and many difficulties can follow. To prevent these difficulties with anticipation, the handler can follow this procedure: When the dog accomplishes a correct transition (e.g., rising from down to sit without moving towards the handler), the handler marks this behavior with "GOOD!" Then the handler walks to the dog, removes the primary reward from his/her pocket, and holds the reward very close to the dog's nose while the dog maintains position (obviously some preliminary training is required to gain good control of the dog's behavior in the presence of the reward). When the dog is steady the handler gives the "YES" cue; the dog normally first takes the reward and then breaks from position. Because the dog receives the reward in position, the animal is not encouraged to creep while performing EOL. Because the handler used the "GOOD" to mark the correct transition from down to sit, the dog knows what it is being rewarded for. As a result, with repetition the dog will become more and more proficient at performing EOL without creeping toward the handler. This method of providing reward while the dog is in position, and using "GOOD" to make sure it knows what it is being rewarded for, is called reward in position.

(2) "OK". Another method of releasing the dog from work. For clarity of communication, it is extremely important that the dog know when a particular skill is finished. The verbal cue that the trainer uses to tell the dog that a skill is finished is called the release. We have already discussed how the "YES" marker serves as both a behavior marker and a release cue. The trainer can also release the dog with the cue "OK." The difference between "YES" and "OK" is that while "YES" is a promise to the dog that it will be rewarded after a delay, "OK" is used to release the dog from work when the trainer does not intend to give the dog a primary reward. This can be the case when the dog will merely be praised, or when the dog has made a mistake, and the trainer intends to make it repeat the exercise correctly before providing a reward.

e. Rewards Used In Obedience Training. CST (like virtually every effective system for teaching obedience to working dogs) relies heavily on positive reinforcement to teach lessons and motivate performance. Sources of positive reinforcement are praise, food, tug toys, and ball or kong.

(1) Praise. Praise and social reinforcement are vital ingredients to working dog training, and some dogs can be obedience trained with nothing, but praise as a positive reinforcer, combined with corrections to discourage disobedience. The problem is that few of the dogs that DoD procures are trainable with this method. They are not socialized in the way that pet dogs or sport dogs are socialized, and without a background of proper socialization, praise alone is often not sufficient to support efficient training. In addition, praise suffers from one great disadvantage. Praise does not provide us with a focal point or goal that we can use to attract, lure, and manipulate the dog, the way we can with, for instance, a handful of food.

(2) Food. Food is a very effective positive reinforcer for many dogs, but eventually we must wean the dog off of food and find other sources of motivation that are more operationally practical. In addition, a substantial number of the dogs procured by DoD do not have enough desire for treat food to perform useful training.

(3) Tug Toy. Many dogs work well for the opportunity to play with a tug toy, but not all. Dogs that are bought for detection only may exhibit little desire to bite and tug on an object.

(4) Ball. This leaves one remaining source of motivation, ball or kong (hereafter referred to as "ball"). This is just as well, because the ball is cheap, easily carried and used, and every military dog is selected especially for its intense desire to chase, carry, and play with balls. Many DoD trainers (educated in the "escape" method of obedience training) never allow an MWD to play with its ball except in the course of detection training, for fear that ball-play will de-value the dog's primary reward for detection training. However, as long as the dog has high levels of retrieve/play drive, this is an outmoded and unnecessary practice. Countless highly effective detector dogs are allowed to play with the ball in obedience and sometimes just for exercise and the sheer fun of it, and they do not lose their effectiveness in detection. On the contrary, ball play keeps their enthusiasm for the ball high, and their physical condition and stamina high as well.

f. Corrections Used In Patrol Training. CST resembles traditional methods of dog training in that it makes extensive use of physical inputs called "corrections." Corrections are designed to do three things for the trainer: a) increase the dog's precision of performance, b) reduce dependency on primary rewards (food, ball/kong, and tug toy), and c) ensure that the dog performs correctly regardless of distractions. Fundamentally, corrections accomplish these functions by exerting punishment and negative reinforcement effects. By definition, effective corrections are unpleasant for the dog. The responsibility of the trainer is to use this unpleasantness for proper effect, while treating the animal fairly and humanely, and ensuring that, although moments of the dog's training are unpleasant, on the whole it enjoys training, and has affection and trust for the trainer rather than fear.

(1) Humane Versus Inhumane Corrections. Barring techniques that are likely to produce physical injury, it is not possible to categorize certain forms of correction as humane and others as inhumane simply on the basis of the physical parameters of the corrections. The primary concerns in judging whether a given correction technique is humane in a certain situation are:

(a) Will the correction cause physical injury? A correction procedure that causes physical injury to the dog, or is likely to cause physical injury, is inhumane.



(b) Does the dog understand what behavior is required of it in this situation? If the dog does not understand what behavior is required, or cannot very quickly learn the required behavior, then the procedure is inhumane.

(c) Is the dog capable of executing the desired response in this situation? The dog may be incapable of executing the response, even though it understands the response (i.e., it may not be able to sit quickly, because it is too physically tense and apprehensive to do so, or it may not be able to release a bite object on command because severe treatment has conditioned biting to the pain of collar corrections). If the dog is incapable of executing the desired response, then the procedure is inhumane.

(d) Does the dog learn from the correction, so that it quickly changes its behavior and thereby avoids further corrections? If the procedure does produce learning, with the result that the dog continues to experience correction in training session after training session, then it is inhumane.

(2) By the above definitions, procedures involving rather mild corrections may be inhumane, because they are not effective for one reason or another and the dog never learns to prevent them. Even mild events, if they are chronic and unpleasant and uncontrollable, can cause significant suffering. By the same token, procedures that appear rigorous and severe may be eminently humane because they do not injure the dog, and because they result in rapid learning and no more corrections. These are subjective judgments best made by experts in dog training, but these experts must always be prepared to justify their procedures and practices on the basis of tab G2, paragraph 2.f(1). Ultimately, perhaps the best indicator of what is humane and what is not is the dog. Is the animal eager for work and eager for contact with its trainer at all times? If so, then it is likely that this dog's training is conducted humanely. Or does it consistently show inhibition, avoidance behavior, and fear in training contexts? If so, then it is likely that at some point the dog was treated inhumanely.

### (3) Tools and Methods for Correction

(a) Choke Collars. Choke collars may be made of nylon webbing, light or heavy chain, or nylon cord, connecting two metal rings. In general, the thinner and smaller the chain or cord, and the more efficiently it runs through the rings, the

24 FEB 2020

more severe a collar it is, because forces exerted through the collar on the dog's neck are distributed over a smaller area. The choke collar is used either to make a jerking correction followed by an immediate release of pressure (i.e., a "pop"), or by exerting a steady pull to produce a choking sensation. Choke chains are very well-accepted in American life and are sold wherever pet supplies are sold.

(b) Pinch (or Prong) Collars. Pinch/prong collars are assemblies of heavy, bent wire links arranged with a chain yoke, so that when the leash attached to the yoke is pulled, the links tighten on the dog's neck and the dull ends of the wire links exert pressure on the dog's neck. They produce a sharper sensation than choke collars do, and can be used with a lighter touch and more precise timing, because less force is needed to get an equivalent effect. Pinch collars are generally used by jerking or popping the attached leash. They are also very well accepted in American life and are sold wherever pet supplies are sold.

(c) Social Corrections. Slaps or cuffs of the foot, hand, or leash-end, or pokes of the fingers. In many circumstances, the quickest and most efficient correction is made by gently slapping the dog with hand, foot, or leash-end, or by poking the dog with stiffened fingers, especially when the handler's intent is to stop the dog from moving forward or biting. Such corrections have the advantage that they do not depend upon the presence of leash and collar, and therefore, if used properly, give the handler greater control over the dog in a wider range of situations. Appropriate, effective, and humane examples are:

1. The handler commands the dog to lie down while the MWD team is heeling rapidly forward (as when an MWD team is running from one position of cover to another in a fire zone). The dog does not lie down quickly, and the handler slaps the dog on the back or neck or ears with the hand or the leash end. The handler then heels forward again rapidly and repeats the command and, if the dog complies rapidly, it is praised and petted and given food reward while in down position.

2. The handler commands the dog to release a ball, the dog does so, and the ball drops to the ground and comes to rest. The handler commands the dog to "STAY" and reaches to take the ball, but as he/she does so, the dog attempts to bite the ball, and thereby the handler's fingers. The handler says "NO" and cuffs the dog sharply on the side of

24 FEB 2020

the muzzle with the open palm of the other hand. As a result, a moment later the dog is somewhat tentative in taking the ball from the handler's hands, even when invited to do so, and the handler praises and encourages this respect for his/her hands/fingers.

3. The handler holds the dog on a six-foot leash and gives the "HEEL" command, but the dog is distracted by nearby activity, is reluctant to obey, and keeps turning its head and forequarters away and pulling into the leash, making it difficult for the handler to get enough slack on the leash to give a "popping" leash correction; so, the handler uses the instep of his/her foot to slap the dog sharply on the big muscle at the back of the thigh. The dog, startled, turns to look at the handler, and the handler instantly encourages the dog to come by praising it and running backwards, and then gives the dog a ball reward.

(d) Electronic/Electric Collars (E-Collar). See tab G-4.

### 3. Obedience Training with CST

#### a. Sit and Down

##### (1) Teaching Sit and Down

(a) Sit and Down are best taught by luring the dog into position with soft, appetizing food. This food must be something like small pieces of meat or specialty dog food that the dog is eager for and that it swallows quickly without chewing. Crunchy treats do not work well. The dog is first taught to eat from the hand and then taught to maintain soft contact with the hand and follow the hand until it is allowed to eat. Then the handler uses the closed hand to lure the dog into position (square, erect sit; or sphinx-like down position with both elbows in contact with the ground), and then loosens the hand so that the dog can lick and nibble the food out of it while holding position. Then, before the dog breaks position the handler releases the dog by saying "OK" and enticing the dog out of position. Through a number of steps, this is developed into sit and down on command with stay (for five or six seconds), using the dog's food motivation only.

(b) The same method can be used with the ball, but because the dog's level of excitement will be much higher than in the case of food, the technique requires more skill and

24 FEB 2020

experience. In addition, prior to luring the dog into position using the ball, the animal must be taught to release it cleanly on command ("OUT"), to refrain from biting the reward until given permission, and to respect (i.e., not bite) the trainer's hands. The handler must be able to hold the ball/kong in his/her hand an inch or two from the dog's head without having the dog take the ball until it is given permission. In addition, the dog must learn to follow the hand closely, the way a dog would naturally follow a hand in which food is held, but without snapping at or biting the hand.

(c) "SIT" and "DOWN" commands are given as the dog is lured into position. "GOOD" is used when the dog is holding position well, before the dog is fed. The dog is fed in position, without being released. "OK" and enticement are used to release the dog from position. "NO" is used to mark errors, and to tell the dog that it will not be rewarded. For instance, the dog is in down position, the trainer moves the hand towards its nose to feed it, the dog begins to crawl towards the hand to eat, the trainer says "NO" and stands upright, and withdrawing the hand and the food until the dog re-stabilizes in down position. "STAY" may be used to steady the dog in position, once longer sits and downs are introduced.

(d) The "YES"-release marker is not employed until the dog is proficient at sit and down, stays in position until it hears the "OK" cue, and has had many rewards in position. "YES" is introduced by having the dog sit or lie down, saying "YES," enticing the dog out of position (so that it releases), and then feeding the dog. "YES" may be used with food reward or ball reward interchangeably.

## (2) Training Sit and Down

(a) The first training of sit and down begins with the stay component rather than the actual sitting or downing motion. That is to say, when we begin to prepare the dog for the experience of being forced to sit or lie down, we apply the force to make the dog stay in sit or down position, rather than sit or lie down in the first place. The handler uses a handful of food to lure the dog into position and then rewards the animal. Then he/she tells the dog to "STAY" and waits for a mistake. In fact, the handler does whatever is necessary to cause the dog to break the stay: stands upright, holds the stay an unusually long time, etc. When the dog attempts to break (prematurely release from) the stay the handler applies a very quick, but rather gentle pop on the leash (up and away from the

24 FEB 2020

handler in the case of the sit, and directly backwards along the dog's spine in the case of the down), sufficient to stop the dog from breaking, and then the handler quickly brings the food hand back and feeds the dog and repeats the exercise. When this is done skillfully it is not clear what keeps the dog in position, the collar correction or the dog's fixation on the food-bearing hand. With time the dog comes to associate the leash correction with sit and down position. Now we can begin to use collar corrections to enforce the "SIT" and "DOWN" motions, in addition to the "STAY".

(b) Alternate mode of correction for the down. For the down, especially, it is very advantageous for the handler to use a social correction (see tab G2, paragraph 2.f(3)(c)), a slapping correction rather than a collar correction, because a slap is normally faster and if done well a slap is more effective in pressing the dog into the down position. But we cannot just suddenly slap a dog with leash or hand and expect it to understand. The animal must learn the meaning of this correction and connect it to the previously understood skill. The handler stands with food in hand and signals the dog into the down with a long hand movement towards the ground and past the dog's nose, with food in the hand. This is merely an exaggeration of the movement the handler normally uses to lure/signal the dog into down position with food. Once the dog is down, it is fed in position, then given the "SIT" command, enticed up to the sitting position, and then signaled back into the down. This sequence of sit-down-sit-down is repeated several times. After this repetition, the dog will anticipate the next "DOWN" command and it will be waiting eagerly to lie down. As the handler again makes the long downward hand gesture combined with the command "DOWN," he/she clips or cuffs the dog rather gently on the muzzle with the ends of the fingers. The dog will notice the contact, perhaps blink or flinch away, and then quickly lie down because both force of habit and the near proximity of the food will guide it into this well-rehearsed behavior. We must be clear; we are not forcing the dog to lie down. The animal is lying down voluntarily to obtain the food. Before it even feels the contact of fingers on its muzzle it is already beginning the down motion. But we are preparing the dog (training phase) for the experience of being forced to lie down (proofing phase).

(c) Proofing Sit and Down

1. During proofing of the sit and down skills we begin to challenge the dog's understanding, with more

24 FEB 2020

distracting surroundings and longer stays, less frequent food or ball reinforcement, and more praise reinforcement instead. When the dog performs correctly it is rewarded and encouraged, and when it refuses commands or becomes distracted, the corrections that were introduced and "attached" to the exercises during training are used in a stronger form, to ensure compliance. For instance, if the dog refuses to sit it is given a quick, popping collar correction upwards. If it refuses to lie down the handler slaps it lightly, but sharply on top of the neck or skull with the flattened hand or with a loop of the leash.

2. As a rule, early in the proofing process, to keep the animal motivated and reduce stress, we tend to give the dog rewards after a correction. For instance, if the trainer gives a "SIT" command, but the dog is distracted by another dog nearby and therefore does not sit, the handler delivers a quick, popping correction on the leash/collar, the dog sits, and then the handler rewards (either with "YES" and release, or "GOOD," "YES," and release, see tab G2, paragraph 2.d(1)(d), this Chapter). Rewards after corrections help to reduce stress, and help the dog "keep trying" even under a little bit of pressure.

3. Later in proofing, we raise our standard. If the dog must be corrected to secure compliance, then the animal does not receive any reward beyond a bit of praise and petting. Then the dog is released and immediately asked to repeat the exercise. If this repetition is correct, then the dog is rewarded.

4. We should always keep in mind the difference between a mistake on the dog's part, where the animal is trying to do as the trainer asks, but just makes an error, and disobedience or refusal. As a rule we do not often correct simple errors, instead we punish them with the word "NO" and we withhold reward (omission). Sharp corrections (positive punishment and negative reinforcement) are normally reserved for disobedience or refusal.

5. During proofing of sit and down, the motivation is normally supplied by ball; the dog is initially taught using food if possible and then once it understands the exercises the ball is introduced. Introduction of the ball will result in the dog becoming much more excited than it did when working for food. Ball motivation is thus a good way to challenge the dog so that it makes a few mistakes, and also it helps the dog to shake off any discouragement or stress it feels as psychological pressure gradually becomes a part of training.

(3) Communication During Sit and Down

(a) While initially teaching the sit and down with food, verbal cues are of relatively little importance. The handler's gestures as he/she lures with food are most important. However, we normally give the "SIT" or "DOWN" command as we lure the dog into position, praise the dog with "GOOD" before and during reward, and release with the cue "OK." Later, as we move into **training** and **proofing** stages and begin to use ball reward, these verbal cues become very important, and we also begin to make use of the markers, "YES," and "NO".

(b) Reward in Position for Sit and Down. Our first concern with sit and down is establishing stability, making the dog understand that its job is to stay still without fidgeting or creeping. The best way to do this is to make sure that the animal receives its reward while it is still holding the sit or down. This is called a "reward in position" (tab G2, paragraph 2.d(1)(d)1). For both "SIT" and "DOWN", reward in position is performed as follows: the handler, with the ball in pocket, gives the "SIT" or "DOWN" command. When the dog moves swiftly and correctly into the appropriate position, then the handler marks this behavior with the "GOOD" cue (intermediate marker). This cue tells the dog that it performed well and earned reward, but that it must not break position yet. Then the handler gets the ball out of his/her pocket and holds the ball very closely in front of the dog's nose. Some care and a bit of training is required so that the dog does not creep or break position as the ball is brought out, and does not try to take the ball before given permission. After a moment in which the handler makes sure the dog is steady, he/she gives the "YES" cue (terminal bridge) which is the dog's authorization to take the ball. If this technique is done well, the dog takes the ball while still in position and then releases from the position. Use of "GOOD" and "YES" cues, combined with reward in position, achieves the twin goals of making sure we mark and reward the correct movement into sit or down position, yet also keep the position stable and prevent creeping, fidgeting, or breaking towards the handler and reward. **Reward in position (using "good" then "YES"-release) teaches the dog to hold a position.**

(c) "YES"-Release for Sit and Down. Once we have a stable sit or down, our next concern is making sure that the dog understands that the correct response to the commands "SIT" or "DOWN" is a rapid, crisp movement. To do this we must reward the sit or down movement, rather than the stay. What is

24 FEB 2020

important here is that we pick out and mark the critical aspect of the skill; in the case of the sit, the moment the dog fully sits, and in the case of the down, the moment that the dog gets both elbows in contact with the ground. Using the down as our example, the handler does this by giving the "YES" cue the instant both elbows are in contact. When it hears "YES," the dog will release from position and wait to be rewarded. The handler then breaks position and retrieves the ball from his/her pocket and gives it to the dog. The handler must not be in a hurry to get the ball out, and it is extremely important that the handler not break his/her position until after he/she has said "YES." The critical aspect of timing here is when the handler says "yes." The "YES" must be timely, but the delivery of the ball can be and should be done deliberately and without hurry. Remember that the function and value of the "YES" terminal marker is that it bridges delays to reward. Therefore, if the "YES" is properly conditioned and well-timed, there is no need to hurry in delivering the ball. **Reward at completion of a movement (with "YES"-release) teaches the dog speed in assuming a position.**

(d) "NO" Marker. "GOOD" and "YES" are not the only markers we can use, nor is the power of marking technique limited to rewards. We can also mark behaviors we want to punish, by using the word "NO." "NO" is used much like "YES," in the sense that it is used to mark a behavior, and bridge a delay; in this case a delay to punishment. Earlier we covered two kinds of punishing response contingencies, positive punishment (giving the dog something that it dislikes) and negative punishment (or omission, taking away from the dog something that it likes). "NO" can serve to signal both of these response contingencies. "NO" is also used like "YES" in the sense that it tends to be a terminal cue; when the dog does something that earns a "NO," the animal often has to start the whole exercise again and therefore it can break when it hears "NO".

(e) We can use the "NO" to gently punish the dog (through omission) for overeager or careless mistakes. For instance, if we are working the dog through a sit-down-sit sequence, and the dog does not wait for the sit command, but pops up without permission, then the handler gives the "NO" and makes the dog go back into the down again and wait for the command before rising up into sit. If the animal rises to the sit correctly, it can be rewarded in position with "GOOD" and "YES," or it can be rewarded with "YES" and allowed to break



immediately. Here the "NO" gives us the ability to improve performance without killing the enthusiasm of an eager dog.

(f) We can also use the "NO" more forcefully as a predictor of physical (positive) punishment. Let us say the handler leaves the dog on a down-stay and steps a few feet away, and the dog breaks position and moves toward the handler without permission. If the handler then simply corrects the dog, the animal will be corrected in the act of approaching the handler, which can be hopelessly confusing for an eager dog. What is needed is a tool to tell the dog exactly what critical behavior "earned" it the punishment. Therefore, the handler gives the "NO" immediately when the dog's elbows lift from the ground. Then the handler calmly approaches the dog and administers a correction of appropriate strength for the dog, normally by popping the leash two or three times, then takes the dog back to the exact place where the dog was lying and commands it to lie down. Then the handler steps away and, if the dog holds position correctly, the handler performs a reward in position: first "GOOD" to reinforce the act of holding position, then approach and placement of the ball directly in front of the dog's nose, and "YES" to release the dog into the ball.

#### (4) Advanced Sit and Down Exercises

(a) To meet certification standards, the dog must eventually learn to transition from sit to down and back up to sit again at heel position, and while at EOL. For these exercises, the dog must not only understand sit and down, but also how to move from one position to the other without creeping forward or changing its alignment. This is where "GOOD" and "YES" and "NO" cues come into their own, because they give the handler the power to teach the dog to understand the difference between a perfectly correct down (in which the dog does not creep forward) and an incorrect down (in which the dog lies down every bit as fast, but creeps forward as it does so).

(b) For sit and down EOL, "GOOD" is used to let the dog know immediately when it has performed a correct sit or down, and then the handler approaches and delivers reward in position (by putting the ball close to the dog's head and releasing the dog into it with "YES"). If the dog creeps as it transitions from sit to down or vice versa, then the handler marks the mistake with "NO," and either makes the dog repeat the skill or calmly delivers a correction and then makes the dog repeat the skill.

(c) For sit and down at heel, "GOOD" is used in the same way to mark a correct transition. Reward in position is performed by taking the ball from the pocket and holding it directly in front of the dog's nose at heel position, and then releasing the dog into it with "YES." If the dog creeps forward or slews sideways at heel while performing the transition, the handler marks the error with "NO," (perhaps followed by a correction) and sends the dog back to correct heel (see tab G2, paragraph 3.c(1)) in the original posture (sit or down). Then the handler makes the dog repeat the exercise, rewarding the dog in position if it is executed correctly.

(d) For real-world operations/utilization, the down has greater importance than the sit. The down is the dog's most stable position. When given the "DOWN" command the dog must drop immediately no matter where it is and what speed it is travelling, and then lie still and silent until given another command or released, even under intense distraction (gunshots, decoys carrying bite equipment and cracking whips, etc.). Accordingly, substantial psychological pressure must often be applied to achieve this level of obedience. In order for such treatment to be fair and effective, corrections used for the down must be thoroughly **trained** (see tab G2, paragraph 2.b(2)), and "GOOD," "YES," and "NO" must be properly applied so that the dog understands what it is being corrected for and can adjust its behavior to avoid corrections.

b. Heeling (Marching)

(1) Heeling is an attention-based exercise in which the dog walks at its handler's left side (personnel who carry weapons on the left side often teach the dog to heel on the right) with the shoulder even with the handler's knee, keeping pace and position no matter what the handler's pace or direction, and sitting automatically when the handler halts. The primary functions of heeling are to refine the dog's obedience to its handler, and to provide the ability to transport the dog under close control through hazardous or distracting circumstances with both hands free. A well-trained dog concentrates completely on its handler while heeling, and heeling is therefore very fatiguing and not an appropriate way to transport the dog long distances. For mere transportation, where all that is important is that the dog remains under control, does not pull against the leash, and does not use any more energy than necessary, a "walk easy" skill is used instead. Walk easy (the command is normally "easy") is much less strict and demanding than heeling.

(2) It is traditional in DoD to use the verbal command "HEEL," and also slap the left hip with the left hand, and to repeat these verbal and gestural commands at each change of pace or direction. However, if we view heeling as a tactical tool rather than a parade-ground skill, then we must realize that, a) slapping the hip is unnecessary and inadvisable, because the left hand should be left free (for weapon-handling, for instance), and b) repeated commands are also unnecessary and inadvisable, because the verbal command "HEEL" is all that is necessary to tell the dog that it should place itself at heel position and remain there, no matter what the handler's movement or direction, until released. Accordingly, in the discussion of heeling that follows, the left-hip slap and repeated commands are not used. The CST method for teaching heeling described below normally results in a dog that positions itself for marching close to the handler's left knee and hip, with the handler's left hand hanging or swinging outside of the dog's head. In effect, the dog positions itself "between" the handler's left hand and hip and looks directly up at the handler's face, rather than positioning itself "outside of" the handler's hand and arm and looking around the handler's elbow at the handler. This close positioning is in most situations advantageous because it gives better and closer control of the dog and results in fewer training problems and less stress for the dog. Weapons retention is not normally an issue for law enforcement applications because the dog works on the handler's non-weapon-carrying side and the handler need not carry the left arm pinched close to the body (a left-handed handler normally trains the dog to heel on the right side and so can carry the right arm loosely while holding the left arm tight to the body for weapons retention).

(3) The CST method of teaching heeling concentrates on teaching the dog to understand the exact position that it must maintain at heel, how to move its body in order to reach that position, and on making sure that the dog is highly motivated for the work. This is the best way to prepare the dog for the physical corrections that may later be necessary to render heeling "fail safe" for real-world tactical scenarios, in which handler safety depends on his/her control of the dog.

c. Teaching Heeling

(1) The Finish. The dog first learns to heel not by walking at the handler's left side, but instead by learning to "finish." "Finish" is an expression used by competitive

24 FEB 2020

obedience trainers to describe a skill in which the dog moves from position in front of the handler to heel position. In DoD, the dog does not normally walk around behind the handler, passing to the handler's right; instead the dog passes by the handler's left hand, turns in place and sits at heel (called the "military" finish).

(2) To teach the finish the dog is lured with food or the ball (in the left hand) from position in front, past the handler's left side, and behind the handler about two or three feet (the handler normally takes one long step back with his/her left foot). Then the handler turns the dog in towards himself/herself (the dog turns counter-clockwise), and leads the dog forward into heel position and asks the dog to "SIT". When using food, the handler then allows the dog to eat from the left hand while in heel position. When using the ball, the handler holds the ball in the left hand just in front of the dog's nose, gives the "YES," and flicks the ball into the dog's mouth. Initially the handler leads the dog through the entire path, covering nearly as much ground as the dog does. With time the handler moves less and less, taking a smaller step backward and shortening the circle he/she makes with the left hand and the reward. Eventually the handler does not step backward with the left foot, simply commanding the dog to "HEEL" and making a long gesture with the left hand to send the dog past the left side and behind, and turn the dog and bring it back up into heel position. The amount of room the dog is given to accomplish the movement is gradually decreased, and when the entire teaching sequence is performed well, the dog begins "flipping" or "swinging" to heel position (rather than walking behind the handler, turning around, and walking up into heel position). A wall or barrier is often used initially, to help the dog reach a straight heel position at the conclusion of the movement. If the dog sits crookedly or too far forward, the handler gives the "NO" cue and makes the animal repeat the whole exercise correctly before rewarding.

(3) In the next step the dog's attention is shifted from the left hand to the handler's armpit. When the dog reaches heel position, the handler marks this behavior with "GOOD", and then carefully moves the left hand and the ball up above the dog's head to a position just in front of/under the armpit. Then he/she gives the "YES" and drops the ball into the dog's mouth.

(4) After a few repetitions, the handler actually places the ball in his/her armpit prior to rewarding the dog. The

24 FEB 2020

movement begins as before. The dog is led through the finish with the ball in the left hand, concluding with the dog at heel position and the ball held directly in front of the dog's nose or on the left side of the dog's head. The handler then marks the correct completion of the exercise with "GOOD," and then raises the left hand above the dog's head, transfers the ball to the right hand, and places the ball in the left armpit, clamping it there with the bicep. Then the handler drops both hands to natural positions, with the left as always hanging just outside of the dog's head. The dog should stare straight up towards the ball from heel position. The handler rewards the dog by saying "YES" (the dog will normally release and rear straight up towards the ball) and delivering the ball directly into the dog's mouth by unclamping the bicep so that the ball drops free.

(5) Reward in Position at Heel. Eventually, the handler begins leaving the ball in his/her pocket until the dog correctly finishes. We now expect the dog to complete the finish in order to obtain the ball reward, but without seeing or following the ball reward. The handler makes the same motion with the left hand, and even cups the hand as though he/she is holding a ball, but the ball remains in the right pocket (at this point the leash is normally transferred to the left hand for the first time and held in a manner similar to holding the ball). When the dog reaches correct heel position, the handler marks with "GOOD," and reaches with his/her right hand into the right pocket, withdraws the ball, reaches across the body and places the ball in the left armpit, and then says "YES" and drops the ball. This is a type of reward in position technique (see tab G2, paragraph 2.d(1)(d)1).

(6) Another technique for reward in position at heel. In a variation on this procedure, the handler does not place the ball in his/her armpit after the "GOOD" cue, but instead places the right hand with the ball directly in front of the dog's head, or to the left of the dog's head (to bend the dog's head away from the handler and straighten the animal's spine) and then gives the "YES" release and rewards in position. Once the dog can correctly complete this skill, it has learned a specific position and a specific movement that will become the basis of heeling/marching.

(7) Eventually the gesture of the left hand (the prompt) that is used to send the dog to heel is faded out, so that the dog swings into correct heel position and into attention on the word "HEEL" alone.

24 FEB 2020

(8) Now we are ready to teach heeling proper, actual marching with the dog at heel position. Initially the handler keeps the ball in the left armpit to give the dog a focal point. Holding a very, very short leash in the left hand (from three to eight inches, but without any tension on the leash between hand and the dog's collar), with the hand outside of and just behind the dog's head, the handler gives the command "HEEL" and shuffles very carefully forward a few feet. When the dog moves well, between the handler's left hand and hip while looking straight up at the ball held in the handler's armpit, then the handler marks this behavior with "GOOD," and comes to a halt carefully so that the dog does not lose position (initial heeling is often performed along a wall or fence). Once the dog is in sit-halt position, then the handler gives the "YES" release and drops the ball into the dog's mouth. It is important to remember that in the initial stages of marching, the dog is rewarded after only a few steps, and normally always in the sit halt. That is, when the dog moves well, the handler marks this with "GOOD" and then comes to a halt and performs reward in position.

(9) With further practice the trainer can leave the ball in the right pocket, asking the dog to move at heel while looking up at the handler's face or armpit rather than the ball. Once the dog moves well, then the handler marks this behavior with "GOOD," comes to a halt, takes the ball out of the pocket with the right hand and then performs reward in position in one of the two ways described in tab G2, paragraphs 3.c(5) and (6). Place the ball in the left armpit and drop it to the dog after saying "YES," or transfer it to the left hand and hold it near the dog's head while it is sitting in heel position, and then flicking it into the dog's mouth after saying "YES." Gradually the dog is taught to heel for longer periods with the ball in sight and without the ball in sight, depending on the circumstances.

(10) Eventually, the heeling pattern is made longer, with turns and halts and changes of pace, and the dog is made to work for extended periods for the "GOOD" and the "YES" and the reward. If, while moving, the dog loses position by running wide or forging forward or swinging out into a crabbing motion, then the handler marks this error with "NO," halts, and re-commands the dog to finish to heel. Once the dog is back in correct position, the handler encourages with "GOOD" and resumes heeling again. If the dog this time maintains correct position it is given "GOOD," sit-halt, and reward in position as in tab G2, paragraphs 3.c(5) and (6).

(11) Up until this point, the "YES" has normally been given only after the "GOOD," as a way of releasing the dog into the ball. This practice has been advantageous because it served to make sure that the dog always got its reward while holding the desired position. Such rewards in place are optimal for making sure that reward anticipation does not interfere with steadiness in the sit and down and correct position while heeling. However, they do not make full use of the power of the well-conditioned "YES," to instantaneously identify to the dog, and reward, very specific aspects of performance. But now we are ready to begin using the full potential of the "YES".

(12) Once the dog shows that it understands how to finish quickly and efficiently to heel position, maintain focus on the handler by looking up towards the handler's face while maintaining correct heel position, move at heel without losing position, and correct itself back to the proper position when it happens to lose position, then we are ready for the final step, in which the handler begins rewarding directly out of heel with the "YES" marker. At any moment that the handler judges the dog should be rewarded, either after the finish, while heeling, or after the dog corrects itself back into position in response to the "NO," then the handler rewards the dog by saying "YES." The dog will release from heel and show that it expects reward, and the handler can then withdraw the ball from the pocket and give it to the dog.

(13) Use of the "YES" marker in this way enables the handler to bring to the dog's attention and selectively reward very fine-grained aspects of performance, such as small differences in speed of movement, angle, or posture. Competitive trainers find this useful because they are interested in polish and speed and precision, because these are the things that win trophies. However, MWD trainers should also be interested in polish and speed and precision, because these are the hallmarks of a dog that fully understands commands and skills: Only when the dog has full understanding is it fair and effective to apply pressure to the dog in order to make sure that it always performs correctly, even under real-world conditions where failure to perform is dangerous for dog and handler and those personnel that depend upon the MWD team.

(14) Note that the "HEEL" command is given only in order to finish the dog, and when the handler first goes into motion. The handler may re-command "HEEL" after a "NO" also. In finished form the command for finish and for heeling is the

24 FEB 2020

verbal command "HEEL" only. There is no gesture of hand or body.

d. Training Heeling. We begin training the heeling skill when the handler no longer has to hold the ball in the left hand to signal/lure the dog to heel position (see tab G2, paragraph 3.c(2)). Now, instead of the ball, the handler holds the leash with no more than twelve to eighteen inches of slack. After saying "HEEL," the handler delivers a slight popping correction on the leash. As always during the training, the leash input does not force the dog to finish. The dog is already on its way to heel position, because of habit and its desire for the ball. This technique merely serves to "connect" heeling and the leash input, and bring the finish under the control of the leash input. Similarly, slight pops can also be given as the dog arrives at heel position to encourage it to stop in the correct place, as it sits, and while it is sitting to encourage it to keep its eyes focused up at the handler. All of these movements are thus brought under the control of leash inputs, so that subsequently the dog will not be confused if it receives a correction (see proofing heeling) for failing to complete any of them quickly enough or correctly.

e. Proofing Heeling

(1) Once the finish and heeling, the halt, and attention to the handler have all been trained/"connected" to leash inputs, then we are ready to begin making the "HEEL" command an obligation for the dog rather than request. This is done by sharpening the leash inputs so that the dog begins to deliberately avoid errors in order to avoid the corrections. Plenty of ball reward is provided during proofing to keep the dog's drive up and ensure that it still enjoys heeling work. Most corrections are preceded by the marker "NO" (given exactly when the dog goes wrong), to make absolutely sure that the dog associates the correction with what it did wrong rather than some other behavior. The handler must realize that if the "NO" is used properly to mark undesirable behaviors, the correction need not be delivered immediately. In fact, in many cases the technique works better if the handler is very deliberate and takes his/her time delivering the correction in a calm and measured manner (as long as the "NO" has been delivered at exactly the right moment).

(2) Corrections for attention, to bring the dog's focus to its handler, are made by lifting the leash-hand quickly directly toward the handler's face. Once the dog comes into



24 FEB 2020

proper attention, then the animal receives "GOOD" and reward in position, or simply the "YES." Almost all other corrections are made directly towards the dog's tail, jerking backwards with the leash held in the left hand, directly behind the dog's head, over its back, with only a few inches of leash held between the hand and the dog's collar. In this way the hand hangs in a natural position just behind and outside of the dog's head, and any input with the leash serves to stop the dog from coming too far forward past the handler's knee. When a dog is taught to heel using the ball (and generating prey/retrieving drive), most of the errors are related to the dog wanting to move too far forward while heeling and come across the handler's body, in anticipation of receiving the ball. The leash corrections just described are ideal for counteracting this tendency and encouraging attention, when combined with proper rewards in position as described above (in tab G2, paragraphs 3.c(5) and (6)).

(3) Once left turns are begun, the same correction will help to prevent the dog from bumping or riding against the handler. When right turns are begun, if necessary the left hand holding the leash is brought from behind the dog's head across the handler's front and up, to generate a correction that brings the dog's head towards the handler's centerline and up towards his/her face.

(4) During the proofing stage, the handler reduces the frequency of ball reward (substituting praise and petting) and asks the dog to heel for longer and longer periods, and with greater and greater distractions. The eventual goal is tactical heeling capability, meaning that the dog finishes to heel from any distance on verbal command, and remains at heel after one command no matter what the handler's pace or direction, off-leash, and under intense distraction (such as gunfire and stimulation from decoys dressed in bite gear cracking whips, etc.).

#### 4. Controlled Aggression Training with Clear Signals Training

##### a. Definitions

(1) Decoy or Agitator. The trainer who plays the role of suspect or aggressor for the dog, and gives the dog bites. The decoy's skill and ability are critical to success in training, accounting for at least 50% of the finished product.

24 FEB 2020

(2) Agitation. The art and practice of provoking aggression and biting behavior from working dogs as performed by the decoy or agitator.

(3) Civil Agitation. Agitation performed by a decoy or agitator who does not wear any bite equipment; hence, "in civil".

(4) Rag. A piece of jute or burlap, often in the form of a feed bag, used to excite and provoke the dog, and allow it to practice biting.

(5) Sleeve. An arm protector worn by the decoy on which the dog bites. In DoD, the sleeve is often referred to as a "wrap," from the days in which bites were given by wrapping the arm with fire hose or similar materials.

(6) Bite-Bar Sleeve. Hard sleeve made with plastic and/or leather barrel, equipped with upper arm protector, and with a blade-like "bite bar" projecting from the forearm area and meant for the dog to bite.

(7) Soft Sleeve. A soft arm protector made of padding and synthetic or jute fabric. Often used to strengthen or "build" the dog's bite for harder sleeves. Also, sometimes referred to as a puppy sleeve.

(8) Intermediate Sleeve. A firm sleeve of padding and synthetic or jute fabric, often patterned after Belgian bite sleeves used for training Ring Sport. In DoD, intermediate sleeves have traditionally not been used. Instead, the bite-bar sleeve was emphasized. Clear signals patrol training makes extensive use of intermediate sleeves for several reasons:

(a) The intermediate sleeve has a better "bite building" effect with many dogs than the bite-bar sleeve.

(b) The intermediate sleeve is more versatile; appropriate for soft biting dogs through very hard biters, and also enabling bites on the upper arm and the insides of the arm.

(c) The intermediate sleeve is safer for the dog; protecting it against impacts, collisions, and twists that break teeth and injure necks and spines when they occur on hard bite-bar sleeves.

24 FEB 2020

(9) Hidden Sleeve. A firm sleeve resembling a very small intermediate sleeve, made so that the hand is exposed, and meant to be worn under the sleeve in a "concealed" fashion. The hidden sleeve is designed to render the biting dog less "equipment dependent".

(10) Bite Suit. A heavy, padded suit with a synthetic fabric outer surface on which the dog can bite anywhere on the arms, legs, or body.

(11) Whip. A short-handled whip with a lash that is used by the decoy to create motion and noise (by cracking it) in order to provoke and excite the dog. Reed sticks and split bamboo batons are used in a similar fashion. All of these instruments may be used to test the dog's nerve and prepare it for combat (use of the whip does not include striking the dog).

(12) Full Bite. A manner of biting in which the dog employs its entire mouth, rather than just the front teeth, while biting. In general, a dog that "bites full" is more confident and reliable than a dog that "bites shallow".

(13) Commitment. The habit of biting without hesitation or prudence, and with full force. A dog that bites with commitment flings itself into the decoy with impact and shuts its mouth instantly with all of its strength.

(14) Equipment-Oriented. The habit or tendency to pull towards, bark at, and try to bite decoys wearing visible bite equipment, or bite equipment itself lying on the ground, rather than the decoy "in civil".

(15) Man-Oriented. A dog showing a great deal of man interest.

(16) Man Interest. The habit or tendency to pull towards, bark at, and try to bite the (unprotected) decoy "in civil" as opposed to a decoy wearing bite equipment, or bite equipment itself lying on the ground. Can also be called "civil aggression," but man interest is a better general term for a dog that tries to close with unprotected agitators, whether it does so because it is hunting them (prey drive) or because it likes to fight (active aggression or dominance drive), or because it has the habit of offensively defending itself when provoked (defense drive).

(17) Transfer. A skill in which a dog voluntarily releases a piece of bite equipment that the decoy drops, and re-directs its attention to the decoy. The dog may transfer because it is a very civil aggressive animal (for which the transfer comes very easily, because the dog's man interest is strong), or because it has been carefully taught to do so. Transfer is used to denote the shift of attention only, not an ensuing bite. Thus, when we say "transfer the dog", we mean that the dog is induced to release the bite equipment and shift its focus back to the decoy. A second bite may or may not then be delivered.

(18) Drives. A term used by dog trainers to describe the intensity and the quality of a dog's goal-motivated behavior.

(a) Prey Drive. The motivation said to cause the dog to search for, chase, and bite objects (including people) that "remind it" of prey animals like rabbits. In prey drive the dog is relatively unstressed. It seems to enjoy itself and does not growl or snarl or show its teeth. It merely chases or approaches and bites. Prey drive is associated with full-mouth biting. The very prey-oriented dog tends to be very equipment-oriented and does not transfer easily from equipment.

(b) Defense Drive. The motivation said to cause the dog to defend itself aggressively from other animals (including people) that threaten or frighten it. When behaving defensively, the dog is stressed, it does not appear to enjoy itself and it growls, snarls, and displays its teeth prominently. A very defensive dog exhibits pronounced signs of fear and stress. The defensive dog is normally very man-oriented and transfers easily from equipment.

(c) Fighting Drive. The motivation said to cause the dog to perform work (like search for prolonged periods) in order to close with, and fight, a person. The behavioral signals said to indicate fighting drive are somewhat indistinct and poorly defined. The term is used mainly to denote a dog that combines characteristics of prey and defense. The animal works with the intensity and man interest typical of self-defense, and appears to be very man-oriented, but does not exhibit the stress and fear typical of a very defensive dog. Also referred to as active aggression, and sometimes as dominance drive.

(19) Nerves. A term used to describe the degree of emotional stability or calmness the dog appears to show while engaged in bite work. A very nervous dog appears anxious and

24 FEB 2020

stressed while working, is prone to snarl and growl, and tends to bite with a small or shifting mouth. A very steady or "clear-headed" dog appears un-stressed while working (although perhaps very excited), is not prone to snarl and growl, and tends to bite with a full mouth without shifting. Dog trainers express these ideas with remarks like "the dog is 'nervy,'" for undesirable behavior, or "the dog has good nerves," or "is clear-headed," for desirable behavior. For dogs that are extremely stressed while biting, normally as a result of excessive or poorly-applied compulsion, the term (from German) "hectic" is frequently used.

(20) Flat Collar. A flat, buckled collar made of nylon webbing or leather and meant for the dog to pull against comfortably. The flat collar should fit loosely and sit low on the dog's neck to provide for comfortable pulling without choking.

(21) Correction Collar. A choke collar made of light chain or of nylon cord, or a pinch collar. The correction collar should fit snugly and ride high on the dog's neck above the flat collar.

(22) Back-Tie. A technique, and the line used for it, in which the dog is anchored by means of a line or rope attached to a secure point (fence or post, or bolt anchored in a wall) and clipped to the dog's flat collar. Depending on the need and the situation, the back-tie is often equipped with an elastic section made of bungee cord or bicycle inner tube that allows the back-tie to stretch and give a few inches, encouraging the dog to pull, and protecting its spine against shocks.

b. Basic Bite Work. MWDs are selected for DoD purchase by means of a consignment test. The patrol portion of this test emphasizes the dog's willingness and ability to defend itself (i.e., defense drive) rather than its raw desire to engage in bite work (prey drive or active aggression). Training for patrol certification and also most types of patrol MWD utilization/deployment (e.g., scouting, building search, and pursuits) require that the dog enjoy bite work (either through hunting/prey behavior, or because the dog likes to fight/active aggression) rather than just be self-defensive. Accordingly the first order of business with a "green" MWD is basic bite work, in which the dog's desire to bite, physical condition and power, and bite-targeting skills are developed. In addition, either in the course of basic training or in the course of more advanced training in the field, the dog must learn to bite any area of

24 FEB 2020

the decoy's body though training on the bite suit, and also learn to bite concealed/hidden sleeves. Exceptionally strong dogs also benefit from attack-work on "civil" decoys in the agitation muzzle. The objectives for basic bite work are:

(1) The dog should confront, with barking and lunging and attempts to bite, an agitator "in civil" that approaches and threatens the animal.

(2) The dog should bite with commitment, power, and as full a mouth as possible on intermediate sleeves, and if possible on hard sleeves.

(3) The dog should transfer (release bite equipment when the decoy drops it), and attempt to approach and bite the decoy in preference to the equipment.

(4) The dog should continue to bite, without excessive growling or shifting of the bite, when threatened and struck with a whip/stick.

(5) The dog should pursue a decoy at full speed over a distance of at least 50 yards, bite with commitment and power, and continue to bite without disturbance as the handler approaches and takes the leash and praises it.

(6) The dog should perform all of the above skills indoors on slick surfaces as well as outdoors.

c. Basic Bite Work Session. All of the above objectives are achieved through training sessions resembling the following:

(1) The dog wears two collars, a flat leather nylon collar and a correction collar, and is attached to a short back-tie anchored well above its back and five to eight feet long. The handler stands near the dog holding the leash (attached to the correction collar). The decoy stands out of sight behind some obstacle, "in civil" with or without whip/stick.

(2) The session begins with the "WATCH'EM" command from the handler, then the decoy steps into view and begins to work, provoking and exciting the dog with threats and aggressive postures and movements. Initially, the dog may have very little reaction when hearing the "WATCH'EM" cue, but after a few sessions, the dog will learn the association between "WATCH'EM" and the appearance of the decoy (classical or Pavlovian

24 FEB 2020

conditioning) and it will become excited and aggressive on command. This is called "alerting" the dog.

(3) In real-world law enforcement and military patrol dog applications, the alert is critically important, because the dog's aggression and biting must be under the control of the handler's command rather than under the control of the decoy's appearance or behavior. A high percentage of patrol dog deployments in which the dog is called upon to engage/bite personnel involve passive subjects, or subjects that may not be moving as vigorously or shouting as loudly as non-target personnel in the area. Accordingly, the handler must have the capability of cuing the dog's drive, so that it wants to bite, and then telling it who to bite.

(4) The decoy works by alternately threatening the dog (by moving directly at the animal, staring into its eyes, pretending to hit or strike at it, and vocalizing angrily), and by yielding to the dog (turning away from the dog, taking a step back, running away, pretending to be afraid). The object of the exercise is to make the dog more resistant and confident in the face of threats, and therefore the decoy must yield when the dog reacts powerfully to threats (i.e., counter-threatens) by lunging forward, barking, or attempting to bite. The handler's role is to encourage the dog (not too loudly) and praise it when the decoy runs away, but the handler should not intrude too much into the situation. The primary trainer in this situation is the decoy and we must let the dog concentrate on him/her.

(5) The decoy has another means of relieving stress, which is to "channel" the dog's energy and emotion from aggression (defensive or active) into prey. The decoy accomplishes this channeling by reacting to a counter-threat with rapid, exciting lateral movement. This "rabbit-like" motion stimulates prey impulses, brings the dog forward offensively, and "unloads" stress.

(6) After a brief passage of civil agitation, the decoy retreats to the hiding place and puts on a pair of intermediate sleeves, one on each arm (see note in tab G2, paragraph 4.a(8)) about intermediate sleeves versus bite-bar sleeves). The handler again alerts the dog with "WATCH'EM," and the decoy appears and re-agitates the dog. This time, when the dog counter-threatens by lunging and/or barking, the decoy delivers a bite on one of the intermediate sleeves. If the dog is very powerful and appears confident, then the decoy can deliver the bite by moving directly into the dog. If the dog appears less

24 FEB 2020

powerful and confident, then the decoy moves laterally, coming close enough for a bite by zigzagging right and left, approaching diagonally.

(7) Note that the quality of the dog's behavior is likely to change noticeably from aggression (defensive or active) to predatory when the decoy wears sleeves, and the result may be that the dog becomes less sensitive and reactive in response to threats from the decoy, instead merely lunging toward the decoy in efforts to engage the equipment.

(8) The bite is delivered by holding the arm high and across the chest or upper abdomen, and encouraging the dog to jump up and strike the sleeve, rather than by swinging the arm into the dog's mouth. Once the dog bites, the agitator struggles with the dog and yells and vocalizes, always being careful not to overwhelm or frighten the dog. If the dog takes a shallow bite or shifts its bite nervously, then the decoy puts tension on the back-tie by leaning backwards, threatening the dog with having the sleeve pulled from its mouth. This should cause the dog to bite harder and, if the agitator suddenly reduces tension on the back-tie and pauses for a moment, it may cause the dog to bite in and take a fuller bite. This act of "biting-in" is often rewarded by resuming movement, or "yielding" to the dog by pretending to stagger or fall back. Sometimes the "bite-in" is rewarded by letting the dog take the sleeve off of the decoy's arm.

(9) When the agitator allows the dog to pull the sleeve off of the arm, he/she steps back out of range of the dog's bite, and immediately begins to agitate the dog. The dog should lose interest in the sleeve and transfer, dropping the loose sleeve and lunging to bite the decoy again. Once the dog transfers, then the decoy delivers a bite on the other intermediate sleeve.

(10) If the dog does not transfer voluntarily, then the handler makes the dog release the sleeve by lifting up on the collar(s). During this process, the decoy stands passive. Once the dog has released the sleeve, then the decoy agitates and delivers the next bite.

(11) While struggling with the dog on the second bite, the agitator uses the free hand to pick up the first sleeve and put it back on. At a moment when the dog is biting well he/she releases the second sleeve, transfers the dog again, and gives another bite on the first sleeve. The session proceeds like



24 FEB 2020

this for three to six bites. On the last transfer, the decoy does not give a bite, instead he/she attracts the dog to the side, away from the grounded sleeve, the handler gets control of the dog, and the decoy runs away with the sleeve. The dog is left victorious, having bitten several times, transferring each time, and finally chasing the decoy away.

(12) This basic session is designed to:

- Teach the dog to alert powerfully on command (by lunging and barking when given the "WATCH'EM" cue, even though it cannot yet see the agitator).
- Strengthen the dog's man interest.
- Build the bite.
- Teach the dog to drop "dead" training equipment and shift its attention back to the decoy (transfer).

d. Intermediate bite work session. The intermediate bite work session progresses much like the basic session, except in three respects:

- The decoy conditions the dog to withstand and fight back against stick-threats.
- The dog is expected to transfer to the decoy in civil.
- The session ends with off-leash pursuit bites.

(1) Counters to Stick-Threats. During the bites, the decoy begins to threaten the dog more vigorously. The decoy does this by looking strongly into the dog's eyes and moving the hands and the stick/whip sharply at the dog's face and body without striking the dog. Initially these threats are relatively weak, but as training proceeds they become more violent and longer in duration, finally concluding in a simulated fight between dog and decoy. If these threats are performed correctly, the dog does not avoid, or "back off" of its bite, instead it "counters" powerfully by "biting in" and pulling and head-shaking. The decoy rewards these "counters" by yielding, and sometimes letting the dog take the sleeve. The result is a dog that knows how to fight a person, and feels confident that it can win the fight, even when the decoy exerts considerable psychological and physical pressure.

(2) The handler's role during this process is to encourage the dog, but not so loudly that he/she distracts or disturbs the animal. At least 90% of the responsibility for training at this point is the decoys.

(3) Because serious fighting, even victorious fighting, causes accumulated stress, the trainers must not pressure the dog during every bite work session. Some sessions are easy, even fun, some sessions are slightly more serious, and very rarely the trainers design a session to test and strengthen the dog's nerve.

(4) Transfer to the Decoy in Civil. When the decoy drops the first sleeve and transfers the dog, and then allows the animal to bite the second sleeve, he/she does not put on the first sleeve again. Instead the agitator leaves the first sleeve on the ground, and then releases the second sleeve to the dog and steps back out of range (i.e., the decoy is now "in civil.") By now, the dog should have learned a very automatic transfer. The moment it recognizes that the decoy has dropped the sleeve, it should release the sleeve and re-direct its focus to the decoy. In this case, the dog is transferring to the "man" rather than to the equipment. The moment the dog transfers, the decoy rewards the dog for this behavior. How the decoy accomplishes this reward depends upon the type of dog.

(5) If the dog is a dog with very high man interest (presumably because it is very high in defense drive or fighting drive) then all the decoy needs to do is to react to the dog by vocalizing and moving vigorously, and then running away. A defensive dog will be gratified because it has chased away the enemy that is causing it stress. An actively aggressive dog (with abundant fighting drive) will be reinforced because it has won possession of the battle ground and increased its sense of dominance. Of course, if either of these types of dog have ample prey drive as well, when the decoy runs away this rapid movement will also stimulate hunting behavior, which is reinforcing for the dog.

(6) If the dog has a higher degree of equipment orientation, so that it tends to be reluctant to transfer from the dead sleeve, or it tends to return to the sleeve after releasing it (presumably because it is a dog in which prey drive predominates) then the decoy must provide a bite reward. If this type of dog does not receive a bite reward of some sort when it transfers to the civil agitator, then it will be "disappointed," or punished (by omission of the bite) for the

24 FEB 2020

transfer and soon it will stop transferring to the civil decoy and continue biting the sleeve when the decoy drops it.

(7) In the case of a very strong-biting dog of this type, the decoy can provide this bite on an arm- or leg-sleeve hidden under the outer clothes. The opportunity to transfer to a decoy that appears to be in civil, and then bite that decoy, teaches the dog a very important lesson. The man is prey. At the conclusion of the bite the decoy drops prone, and the handler removes the dog from the bite physically by lifting upward on the collar(s), and then the decoy runs away.

(8) In the case of a less powerful dog, that may not have the necessary drive and confidence to bite the hidden sleeve, the decoy can pull a jute rag from its hiding place in the waistband at the small of the back and let the dog suddenly bite it. This is not as powerful a technique for producing man interest in a prey/equipment-oriented dog, but it does reward the dog for directing its energy and attention at a civil decoy. After a few seconds of biting and a vigorous fight with the rag, the decoy releases the rag to the dog, transfers the dog from this rag (usually by picking up one of the sleeves), and runs away.

(9) Pursuit Bites. Following a session of bites and transfers to the decoy as above, the decoy runs away in civil and picks up two more intermediate sleeves lying on the ground at the desired distance for the pursuit bite. The handler unhooks the dog from the back-tie and releases the dog to pursue and bite. The decoy takes this bite and keeps the dog occupied with fighting while the handler runs up, being careful not to disturb or frighten the dog, and praises and pets it enthusiastically while it bites. Once the handler has the leash, then the decoy drops the first sleeve and steps back out of range. The dog will transfer, and then the decoy runs back towards the original back-tie location. Again, the handler releases the dog for a pursuit bite, follows the dog up and praises it and regains the leash. The session can end in one of two ways:

(a) If the dog has very high man interest and transfers easily to a civil decoy, ignoring the sleeve after the transfer, then the decoy drops the sleeve, the dog transfers, and the decoy runs away with the dog, restrained by the leash, in hot pursuit. The handler gradually brings the dog to a stop, and the decoy escapes.

24 FEB 2020

(b) If the dog has lesser man interest, so that it is not clear that the dog prefers the decoy to equipment, then during the bite the decoy picks up and puts on one of the original sleeves. Then he/she drops the sleeve the dog is biting, transfers the dog by letting it see the sleeve he/she is wearing, and then the decoy runs away with the dog, restrained by the leash, in hot pursuit. The handler gradually brings the dog to a stop, and the decoy escapes.

e. Controlled Aggression. There are two crucial points in the career of any practical patrol MWD. One of these, of course, is when the dog is first called upon to engage a subject. The other is when the handler for the very first time begins to exert control over the dog during bite work. When we say "control" we mean verbal commands enforced with physical corrections. Depending upon how this stage of the dog's training is performed, it is more or less stressful for the dog, and it is the first "acid-test" of the dog's quality. Many dogs cannot withstand the stress and do not satisfactorily evolve into well-controlled, but hard-biting patrol dogs. Therefore, as in any phase of Clear Signals Training, the trainer's main concern is minimizing the degree of stress the dog suffers by ensuring that the animal understands the skills it is taught, and as much as possible avoiding the use of any substantial corrections until it is clear that the dog understands the target skill and is fully capable of executing the skill. However, in controlled aggression training (as opposed to obedience), because it is often difficult to withhold the reward from the dog in order to punish it (i.e., prevent it from biting), we are necessarily more dependent upon physical correction and compulsive training. Therefore the emphasis in controlled aggression training is on the **training phase** (in which the dog learns what corrections "mean" and how to handle them) and the **proofing phase** (in which the dog learns that it must obey certain commands or it will receive meaningful correction).

(1) Out and Guard Versus Recall. The modern DoD patrol dog is trained to meet an "out and guard" standard. This means that the dog is trained to release the bite on command (or "OUT") and then remain near the decoy, guarding intently (silently or while barking), as opposed to releasing the bite and returning to heel position as was taught during the era of "six phases of controlled aggression." Similarly, when the dog is called out prior to the bite, while it is running downfield after the decoy (i.e., the "stand-off"), it is supposed to halt and remain guarding the decoy. In contrast, the "six phases"

24 FEB 2020

dog was taught to return to heel position after being called out during the stand-off.

(2) The out and guard approach is technically more sound from a training standpoint than the out and recall approach. It is a better platform for teaching the dog to understand the out, and adapt to being controlled by the handler during bite work. However, from a liability point of view, it is inadvisable to have a law enforcement K9, or an MWD used in a law enforcement role, guard a suspect/subject closely, because of the risk and likelihood of unwarranted bites. Similarly, from a tactical point of view, it is extremely dangerous for the handler to have the dog guard the subject **unless the handler has the ability to recall the dog to heel from the guard position**, because in order to recover the dog, the handler must approach the subject while the dog guards, and potentially leave a position of cover for an exposed position to do so.

(3) Therefore, at some point in its career and training, the out and guard patrol MWD should be taught to recall to the handler from the guard, over any distance at which the dog might be sent to engage a suspect.

(4) Out and Guard Standard. In order to be certified as an out and guard patrol MWD, the dog must perform the following exercises:

(a) Field Interview. In which the dog remains at heel and under control while the decoy approaches the handler, converses with him/her, and then departs at a walk.

(b) Attack. In which the dog pursues the decoy on command, bites and holds, outs on command, and then guards while the handler approaches and places himself/herself at heel position.

(c) Search and Escort. In which the dog guards the decoy while the handler searches him/her, and then walks under control with the handler while escorting the decoy back to the starting point.

(d) Search and Re-Attack. In which the dog bites the decoy without being commanded when the decoy attacks the handler during the search.

(e) Stand-Off. In which the dog is called out in mid-pursuit and stops in a standing, sitting, or lying position

and guards the decoy while the handler approaches and places himself/herself at heel position.

The essential aspects of all these skills are taught to the dog in the course of sessions in which the dog is back-tied, with the back-tie attached to the flat collar and the handler holding the correction collar (see tab G2, paragraph 3.a(2)(b)).

(5) Communication During Clear Signals Controlled Aggression Training. If anything, use of clear communication cues is even more important in controlled aggression than it is in obedience, because the dog is intensely excited and therefore easily confused, and because controlled aggression can be extremely stressful for the dog if it becomes confused about what the trainers want, and how to obtain reward and avoid punishment. Fundamentally the same cues/response markers are used in controlled aggression training as in obedience:

(a) "YES"--Signals to the dog that it may release from control and bite the decoy, or try to bite the decoy by pulling against the leash. Often in bite work a trainer will use a word like "GET'EM" instead of "YES", but this word is conditioned and used in controlled aggression exactly as the "YES" is used in obedience, as a terminal bridge (in addition to an alert cue, see tab G2, paragraph 4.c(3)).

(b) In controlled aggression, the bite can be signaled by the handler with "YES"/"GET'EM," or by having the decoy move so as to deliver a bite (i.e., simulating either an attack on the dog, or an attempt to escape). Which approach is used depends on the dog and the specific situation, but as a rule very powerful dogs that are difficult to control receive their bites after a "YES" from the handler (so that they think about their handlers, and their responsibilities to their handlers, all the time during controlled aggression), whereas "softer" dogs, that do not guard as powerfully and worry continually about where their handlers are, receive their bites after a movement by the decoy (so that they think about the decoy all the time and as a result guard more intently).

(c) "GOOD"--Intermediate marker that signals to the dog that it is performing correctly and it will be rewarded with a bite or a chase, but it must continue to perform until released.

(d) "NO"--Signals to the dog that it has made a mistake and it will be punished. The punishment can take two

forms—negative punishment (or omission) in which we withhold reward (the bite) from the dog, and positive punishment, in which we apply some more or less uncomfortable input to the dog (usually a collar correction). The "NO" also tends to be a terminal marker in the sense that any time the dog hears a "NO," it means that the animal has made a mistake and the last exercise will have to be repeated.

(e) The clear signals "NO" versus the traditional DoD "NO." This manner of employing the "NO" is utterly different than the traditional DoD method of using "NO." Typically in DoD, the handler was taught to say "NO" (perhaps many times while giving a continuous correction) and correct the dog simultaneously. This makes the "NO" nothing more than part of the punishment, and it gives the dog very little information. As it is used in CST the "NO" is a much more powerful tool that enables the handler to identify for the dog exactly what it did to "get in trouble" and, if the handler allows, self-correct in order to "get out of trouble".

(f) Out (Release Bite on Command). The out is seemingly the simplest of skills for the dog to execute, simply opening the mouth. But, in releasing the decoy, the dog is relinquishing its grip on the single most motivating object it knows. This means that tremendous psychological currents and emotional turbulence can be caused by the out, especially when strong physical force is used on the dog to accomplish the release. In short, although the out is simple, it is far from easy for the dog, and the better and more powerful the dog, the more difficult it can be for the animal to learn to control itself sufficiently to obey commands. This means that the trainer is under a tremendous obligation to be patient, skilled, fair and humane with the dog in this phase of training. CST methods assist us to meet this obligation by giving us powerful tools for showing the dog what we want it to do, and also by giving us a hierarchical method of adjusting the dog's level of motivation, and hence the difficulty of the exercise for the animal.

(6) Hierarchy of Bite Objects and Motivation. To adjust the dog's level of motivation, the trainer chooses from an assortment of possible bite objects, ranging from very "unappealing" objects like hard wood and plastic, to more motivating objects like rubber hoses and tug toys, to the most motivating bite objects such as decoys wearing sleeves and suits. This range of objects and the range of motivation they produce, from low to high, are called a "hierarchy". The basic

approach to instructing the out in clear signals training is to manipulate this hierarchy so that the dog learns the skill in a situation of the lowest possible stress (using a bite object that the dog "likes" enough to bite, not enough to be stubborn about keeping hold of), and then gradually moving up the hierarchy to the target situation in which the dog is fighting and biting a decoy.

(a) Teaching/Training the Out. Because many "green" [untrained] dogs procured by DoD already have extensive experience at the time of procurement in being choked off of bites with choke collars, and struggling against handlers who are trying to physically control them, often it is not possible to persuade these dogs to perform an entirely inductive, or voluntary, out. Such dogs have already been taught to be resistant and anxious while biting. Therefore, in many cases some sort of physical input or correction is needed to cause the animal to release on command, so that it can be rewarded with another bite. For this reason, because corrections may be involved in even the earliest stages of instructing the dog to out, teaching and training stages are often not distinct, and they are here discussed as one.

1. The out is best taught during play with the handler (low on the hierarchy of motivation), rather than during bite work on a decoy (extremely high on the hierarchy of motivation), because during bite work the dog becomes extremely excited and therefore may require heavy (and stressful, even potentially injurious) corrections, **unless it has already been taught at a lower level of the hierarchy how to release the bite on command for a reward.**

2. An object is chosen that generates low to moderate motivation. For a somewhat "low-drive" dog this might be a tug toy; while for a high-drive or "problem" dog it might be an object like a piece of hard wood or plastic. In the case of the latter type of dog, the goal is to find an object the dog "likes" enough to bite, but not enough to cause it to stubbornly fight the handler in order to retain the object.

3. The handler entices the dog with the bite object, holding it in both hands by the ends, allows the dog to bite it, and then provides a brief "fight" with praise. Then the handler freezes, holding the bite object still, with the leash (with some slack) held in the left hand along with the end of the object.



24 FEB 2020

4. The handler gives the "OUT" command, and then causes the dog to release. Ideally, this is done very gently, either by waiting for the dog to become frustrated by the handler's refusal to play tug of war, or by crowding the dog's mouth off of the bite object with hands and fingers. When neither of these options is practical, a correction is applied, as lightly as possible, by leaning backwards against the back-tie and exerting tension on the correction collar with the leash held in the left hand. Once the dog releases, it is told "GOOD," and a moment later "YES/GET'EM" and enticed to bite the object again.

5. The exercise is practiced several times during a session. On the last out of the session, the dog is rewarded by being allowed to take the bite object from the handler (equivalent to the decoy dropping a bite sleeve). The handler then entices the dog with a second bite object, induces a transfer and a bite, gives the dog that bite object, picks up the first object, and transfers the dog back to the first object again. After a few rewarding transfers, the handler ends the session by using the object in his/her hand to entice the dog to the side, away from the object lying on the ground (that the dog has just transferred from), throws the bite object behind him/her to keep the dog's attention away from the other object lying on the ground, and then steps in and regains control of the dog with the leash. In this way the session ends "with drive" and with pursuit activity, rather than ending with an out and guard followed by no reward bite.

6. The emphasis here is not on trying to cause the dog to out cleanly on command; it is on teaching the dog to release calmly and willingly in order to escape a collar correction, then to guard (rather than back away or otherwise avoid) and confidently re-bite when rewarded with the "YES/"GET'EM" cue. At this point we are not especially concerned if the dog ignores the "OUT" command and waits for the correction to be applied before it releases. However, typically this stage of training, in which the dog is allowed to practice escaping corrections rather than avoiding them, is relatively brief, one or two sessions for a powerful dog that has unshakeable persistence under correction, and several sessions for a softer dog that is more easily upset and put into avoidance behavior.

(b) Proofing the Out. To proof the out, we must drive the dog from escape responding, in which it tends to wait until it feels the correction before it releases the bite

24 FEB 2020

object, to avoidance responding, in which it releases on command in order to avoid the correction entirely. This is done by:

- Moving up one or two levels on the hierarchy of motivation so that the dog begins to disobey the out command reliably.
- Applying a sharper correction.

1. Once the dog has become skilled and comfortable in releasing the bite in order to escape/avoid correction, at a low level on the hierarchy of motivation, we increase the motivation by choosing another object for the dog to bite a little higher on the hierarchy. For a very compliant dog we may move directly to the decoy and bite sleeve. For a more powerful and resistant dog we may continue to practice the out only during play with the handler, and merely move one small step up the hierarchy of objects, for instance from a PVC pipe to a firm rubber hose.

2. In either case, if the dog fails to release on the "OUT" command, the handler applies a sharp correction with the leash and collar, pulling towards himself/herself so that the dog's mouth is pulled "into" the bite object. When the dog releases under this correction, the handler gives the "GOOD" cue (which now takes on the meaning of a "safety signal" telling the dog that discomfort is over and will not re-occur so long as it continues to obey). After a moment of stable, guarding the handler (or decoy, if we are training on the decoy) delivers another bite and immediately freezes, and the "OUT" command is given again. If the dog releases cleanly on command, the handler says "GOOD" (the safety signal reassures the dog, telling it that it has done the right thing and the danger of a correction is past), and then "YES"/"GET'EM," and gives the dog a rewarding bite.

3. In early training, the handler does not say "NO" before correcting. The dog simply receives a rapid correction after the "OUT" if it does not release. In later training, especially when the handler is at some distance and is unable to deliver a correction immediately (so there will be some delay between disobedience of the command and the correction), the handler marks disobedience of the "OUT" command (continuing to bite) with the "NO." Then the handler approaches the dog and calmly and methodically administers the correction.

4. The "GOOD" Cue as a Safety Signal. When we introduce corrections to obedience and patrol training, the

24 FEB 2020

"GOOD" takes on two meanings. It now tells the dog that no correction is coming, that by choosing the right behavior it avoided correction, and it also predicts for the dog that, if it continues to perform well, reward in the form of "YES"/"GET'EM" is on the way. The purpose of this safety signal is to reduce the dog's stress and anxiety. Instead of waiting to see if it will be corrected, it learns immediately that it has found safety from discomfort, and thereby it also learns exactly which behavior earned that safety.

5. The dog is taught not to rebite until the handler signals reward with the "YES"/"GET'EM" release. If the dog attempts to rebite without permission, the handler gives the "NO." After the "NO," in most cases the handler proceeds to calmly and methodically deliver the correction. However, at some points in training it is advisable to omit the correction if the dog exhibits a very respectful response to the "NO" by recoiling from the bite. If the dog self-corrects in this way and the handler decides not to correct, he/she then gives the "GOOD" cue (signaling safety for the dog), pauses a few moments, and then the dog is rewarded.

(7) Guarding the Decoy. Once the dog has learned to reliably out from the decoy on command, then we begin the process of developing the dog's skill and persistence in guarding the decoy. This guarding will be the foundation for nearly all the exercises of controlled aggression such as field interview, search, stand-off, and so forth.

(a) Teaching/Training the Dog to Guard. The dog is still trained on the back-tie, and it learns the first stages of these exercises while working on the back-tie.

1. In DoD the most frequent cause of severe training problems in patrol, and eliminations from patrol training, is failure to guard. The dog leaves the decoy when it should be guarding, waiting for its next opportunity to bite. This problem is most often caused by faulty training, by handlers pressuring and correcting dogs while guarding until the animals' drive is overcome by their anxiety, and they avoid the situation. This behavior is not disobedience, it is avoidance behavior fueled by anxiety and confusion. In order to guard well the dog must be confident that it knows how to guard without biting, confident that it knows when a rebite will be "safe" because it is authorized, and it must trust its handler. Accordingly, CST takes a great deal of trouble teaching the dog

to guard while still on the back-tie, by breaking the guarding into steps.

2. At all times, it is the decoy who causes the dog to guard by enticing the dog subtly and delivering bites at the right times. The handler does not make the dog guard by pressuring it to "STAY!" However, if while guarding the dog rebites without permission, then the handler may deliver the "NO" and correction.

3. Guard during Handler Movement. The first step is to teach the dog to continue guarding while the handler moves. While standing near the dog, holding the leash, the handler takes one step away from the animal. The dog should continue to guard, and then the decoy rewards this behavior by delivering a bite. After the next out the handler takes two steps, and the dog receives a bite, and so on. Eventually we condition the dog to guard intently while the handler walks and even runs about, around the decoy, to the dog and away, behind the dog, etc. If the dog becomes distracted for a moment by the handler and looks away from the decoy, or tries to leave the decoy, then the decoy punishes the animal by jumping away out of range and agitating the dog to produce frustration. If the dog on the other hand becomes unsettled by handler movement and bites the decoy prematurely, then it receives a "NO" and perhaps a correction. If it recoils obediently from the bite on hearing the "NO," then the handler may elect to reassure it with "GOOD" and continue the exercise.

4. Guard during Decoy Movement. In the second phase of teaching guarding, the handler steps to heel position on the guarding dog, tells the animal calmly to "STAY" in a reassuring, but forceful voice, and uses his/her right arm to wave or push the decoy back one small step. This must be done carefully to avoid triggering a premature bite. When the dog allows this step away and continues to quietly guard, the handler rewards with the "GOOD" marker, and then waves the decoy back close to the dog. Once the decoy has stepped up close, with the dog still guarding, then the animal is rewarded with a bite (either after a "YES"/"GET'EM" from the handler or after a sharp movement from the decoy, depending on whether we want to emphasize the dog's attention to the decoy or to the handler).

5. If at any point the dog attempts to rebite prematurely or move away from the decoy, these errors are handled as above. Rebite is met with "NO" from the handler, while avoidance is met by an escape from the decoy.

24 FEB 2020

6. With additional training the dog is taught to remain in a stable guard position on the back-tie while the decoy steps backwards, turns and walks up to 100 feet away; or steps backwards and turns and runs in place; or steps backwards and then turns and runs rapidly away; or steps backwards and stands while the handler searches him/her. (Note that the only situation in which the dog is allowed to bite without command is when the decoy attacks the dog or the handler. If the dog merely sees a person running, this is not authorization to bite.)

7. Reinforcing guarding with reward in position. When the dog obeys the handler by guarding intently while the decoy makes the above-described movements, the handler marks this compliance with "GOOD" and then signals the decoy to approach the dog very closely and stand, and then give the reward bite. The reward bite may be delivered after a "YES"/"GET'EM" from the handler, or in response to the decoy attacking (moving suddenly at) the dog or the handler. In the early stages of teaching the dog to guard, the exercise does not conclude with the dog running downfield and biting; it normally ends with dog being rewarded in the original place on the back-tie where the animal was given the "OUT" command, released the bite, and began to (and continues) to guard. The alert reader will recognize that this is a "reward in position" procedure, identical to the procedure used during obedience to help the dog understand how to remain in place without anticipating or breaking position.

8. Reinforcing the dog for vigilant guarding with a reward out of (i.e., breaking from) position. If the trainer judges it advisable to bring up the dog's intensity or attention to the decoy, the dog can also be given a bite occasionally at any point in any of the exercises by having the decoy suddenly attack or threaten the dog or handler. In response the dog will release from guarding and lunge to the limit of the back-tie (which has a rubber inner tube or bungee cord insert to absorb shock). The decoy can move quickly to the dog and deliver a bite. This is how the dog learns to bite without command when the decoy attacks the handler during a search.

9. Punishing the dog for inattention or looking/moving away from the decoy. If the dog becomes anxious or distracted during any of the guarding exercises, the decoy can punish the dog (through negative punishment, or omission of reward) by suddenly becoming aggressive (but without letting the

24 FEB 2020

dog bite), running away to a hiding place, and then pausing for 30 seconds or a minute before coming back and resuming the exercise. After a few such escapes followed by a frustrating "time out" period, the dog will guard more intently.

10. From this basic out and guard exercise performed on the back-tie, with rewards delivered in guard position, we develop:

- The field interview
- The "false run" (in which the dog remains under control at the handler's side while the decoy walks or runs away)
- The search of the decoy by the handler while the dog guards
- The re-attack during the search

Most importantly, we teach the dog to guard confidently and calmly while the handler approaches and places himself/herself at heel. In order to increase the dog's confidence and steadiness during handler approach, the handler often gives the "YES" after arriving at heel, or the decoy delivers a bite without "YES" by attacking dog or handler.

11. At the end of the session, the dog is normally unhooked from the back-tie and allowed to perform one or two pursuit bites concluding with transfers. However, these bites are not practiced from the guard. The animal is not released (given the "YES"/"GET'EM" command) from the guard to run downfield and bite, because these "thrown attacks" develop tremendous anticipation for the run, and make the dog difficult to control in the guard position. Before the handler begins to send the dog downfield from guard position, we must first do extensive work to make the dog steady at heel, and teach it to guard quietly, without barking, whining, bouncing or lunging, even when the decoy moves off to a distance of 25 or 50 yards. Therefore, all bites from the guard are practiced by having the decoy return to the dog (reward in position), and if the dog is turned loose for a pursuit this is not done from the guard. Instead the handler holds the dog by the flat collar (the dog is encouraged and allowed to lunge and bark so that it knows that it is not "under control"), the decoy runs away, and the dog is released.

(b) Proofing the Guarding Exercises

1. All the exercises involving guarding, whether the decoy is nearby or at a distance, are proofed after extensive and patient teaching/training, so that the dog becomes very confident and stable in guard position, and very accustomed to the "NO" and appropriate collar corrections. This way the dog will not be tempted to avoid the decoy when corrected during a guarding exercise, but instead will resume guarding confidently after it makes a mistake.

2. Proofing is accomplished by increasing the intensity of correction so that the dog begins to avoid mistakes, so as to avoid corrections. If the dog makes a mistake (i.e., breaks guard position or attempts to rebite without permission) when the handler is at a distance, then the handler marks the misbehavior with a "NO" and approaches the dog calmly to correct. If the dog has learned what "NO" means, and been given plenty of practice to understand how to correctly guard, then this procedure will make it afraid of making a mistake again, not make it afraid of its handler approaching.

(8) The Stand-Off. When the stand-off is correctly taught and performed, the dog drops into a down in mid-flight on the command "OUT, DOWN" and guards from this remote position. The dog should not follow up after the out command. That is, it should not run all the way to the decoy and then guard him/her from nearby.

(a) Teaching/Training the Dog to Perform the Stand-Off. A good stand-off depends on recruiting the dog's cooperation with the "OUT, DOWN" command, so that the dog is eager to lie down in order to get its bite. If we begin the stand-off exercise by forcing the dog to lie down, it will be much more difficult to teach.

1. The first step is to teach the dog to earn the bite by lying down. In essence we are teaching the dog to change positions on command while guarding, in order to be "paid." The exercise begins on the back-tie as always, with the dog guarding in sitting position and the decoy standing at a distance from ten to 35 feet. The handler asks the dog to lie down, by giving the "DOWN" command plus whatever additional gestures (kneeling and tapping the ground in front of the dog, etc.) will help the dog to lie down even though it is very interested in the decoy. Once the dog's elbows touch the ground, the handler marks with "GOOD." Then the handler signals

24 FEB 2020

the decoy to come in and stand very close to the dog, and then the dog receives a bite (reward in position). This exercise is repeated until the dog is trying eagerly to lie down (even before it is commanded) anytime the decoy steps back and stands.

2. In the next phase the exercise is repeated in much the same way, but the dog is not commanded "DOWN" when in a sitting guard position, but instead when it is on its feet watching the decoy or even pulling somewhat on the back-tie. In this situation the "OUT, DOWN" command begins to interrupt ongoing activity, rather than just moving the dog from sit-guard to down-guard.

3. Then the dog is taken off of the back-tie and held on-leash. Ideally, for the first exercises the dog is walking forward towards the decoy while leaning a bite against the leash, or some similar low-intensity activity, rather than pulling against the leash and lunging and barking with all its strength. The handler commands "OUT, DOWN," helps the dog to lie down, and then gives the "GOOD" and brings the decoy in to stand close to the dog and deliver the bite, providing the dog guards calmly from the down. With repeated exercises, the dog is allowed to move faster or become more excited, pulling harder against the leash until given the "OUT, DOWN" command. In this way, the "OUT, DOWN" command begins to take on the power to interrupt the dog as it moves forward vigorously (but not off-leash) towards the decoy. At this point we are ready to begin allowing the dog to run free of restraint towards the decoy.

4. Preventing Hesitation. Simultaneously with the work described above (teaching the dog to lie down to earn a bite), we have also been preparing the dog in another way, to prevent problems with hesitation. The dog is set up at heel position next to its handler, with a decoy about 50 to 60 feet away. The dog is not back-tied. Normally the handler holds a six-foot leash which he/she will drop when he/she gives the "GET'EM" command. An assistant stands mid-way between the handler/dog team and the decoy, holding a long line attached to the dog's correction collar. The dog is sent to bite with the command "GET'EM," but the decoy stands passive (although he/she will provide slight enticement if necessary to help the dog bite), so that the dog bites on command alone rather than in response to decoy movement. This procedure is repeated until the dog is thoroughly accustomed to the "stand-off" set-up and shows no hesitation in biting a passive decoy on command.



5. Once the dog downs readily for bite reward even when it is moving vigorously on-leash, and when there is no trace of hesitation when the dog is commanded to bite a passive decoy with the assistant standing mid-way, then we are ready to run the stand-off proper. The set-up is as in tab G2, paragraph 4.e(8)(a)4, with handler and decoy fifty to sixty feet apart and an assistant at the midpoint holding a long line attached to the dog's correction collar. The dog is sent with the "GET'EM" command, but at the half-way point the handler commands "OUT, DOWN." The assistant uses the long line to rather gently check the dog and bring it to a stop. Once the dog is down, the handler gives the "GOOD" marker, advances to heel position, and then signals the decoy to come forward, stand near the dog, and deliver the bite (either after "YES" from the handler or by attacking dog or handler, depending on the needs of the dog). Note that again we are using the reward in position command; to steady the dog in the down and teach it that, once it hears the "OUT, DOWN" command, reward will no longer be earned by running forward towards the agitator, but instead through dropping immediately into the down and guarding.

6. In alternating exercises, set up identically, the dog is sent with "GET'EM," but "OUT, DOWN" is not given. The dog is allowed to continue and bite the passive decoy. The "mixture," or "balance" of bite trials versus stand-off trials is arranged to keep the dog from hesitating (i.e., anticipating the "OUT, DOWN" command and running out slowly when told to "GET'EM"). The decoy never varies his/her behavior, always standing passive until the dog either bites or is called "out, down".

7. Soon the dog should be lying down quickly and eagerly once checked, although it may be necessary for the assistant to use the line to check/stop the dog's forward movement.

(b) Proofing the Stand-Off

1. Proofing is performed by making the checking correction sharper and more uncomfortable, so that the dog begins to check on its own when commanded "OUT, DOWN" in order to avoid the checking correction.

2. Once the dog begins responding reliably to the command "OUT, DOWN" instead of waiting for the assistant to check with the line, then we increase the difficulty of the exercise. The decoy begins stimulating the dog more at the

24 FEB 2020

beginning of the exercise, by walking or running away before the dog is sent. The decoy freezes when the "OUT, DOWN" command is given. Now the decoy's behavior begins to provide a "clue" that helps the dog to perform the stand-off correctly. When the dog performs the exercise correctly at full speed and in full drive, with the line on and an active decoy, then we are ready to take the line off.

3. Initial off-line stand-offs are performed with the decoy standing still. The dog is sent and called "OUT, DOWN." If it performs correctly it is rewarded as before, with a "GOOD" marker and reward in position. If it does not lie down immediately, continuing towards the decoy or even biting, then the handler gives the "NO" command (we often have a short, light leash on the dog's collar so that the agitator can reach up and take this leash if the dog bites). Then the handler advances to the dog and delivers a correction, and then we repeat the exercise. It is useful with a dog that is difficult to control to have an "escape hatch" for the decoy (such as a gate or door very, very close by) so that, if the dog disobeys the "OUT, DOWN" and continues towards the decoy, the decoy can quickly escape through the gate and stand passive. In this way we can prevent the dog from "stealing" reward after disobeying the "OUT, DOWN".

Eventually, the stand-off is run with an active decoy, and the dog can be rewarded for a good "OUT, DOWN" by being given the "YES" as soon as it touches its elbows, allowing it to release forward from the down, and finish its run to the decoy and bite.

**This Page Intentionally Blank**

## TAB G3

### DEFERRED FINAL RESPONSE (DFR)

#### Table of Contents

<u>IDENTIFICATION</u>	<u>TITLE</u>	<u>PAGE</u>
PARAGRAPH		
1	DFR Background.....	G3-1
2	Reward Not from Source Method.....	G3-1
3	Deferred Final Response Method.....	G3-3
4	Overview of the DFR Training Sequence.....	G3-4
5	Liabilities of DFR.....	G3-6
6	Slow or Reluctant Final Response in DFR Dogs.....	G3-7
7	Stop and Stare in DFR Dogs.....	G3-10
8	Issues with DFR Dogs.....	G3-17

#### 1. DFR Background

a. This tab discusses the DFR method for training substance detector dogs that is now in use in the MWD course at 341 TRS. Because Deferred Final-trained dogs are taught to look at source when indicating odor, rather than at their handlers, this method is frequently referred to as "focus training." This tab is provided to assist MWD users in understanding and troubleshooting DFR Dogs.

b. In order to become proficient in substance detection, the dog must acquire two main conditioned associations, or lessons. First, the dog must learn to recognize the target odor, meaning that it must begin to expect reward when it smells that odor. Second, the dog must learn that, in order to receive the reward, it has to sit. This sit is, of course, called the "final response" in DoD terminology.

#### 2. Reward Not from Source Method

a. The traditional DoD method for teaching odor recognition and final response was called Reward Not From Source (or Reward NFS). The dog is encouraged to investigate an area or a scent box, commanded/helped to sit, and then given a reward (ball/kong). Over the course of many trials the dog learns to sniff a series of locations, and sit "on" the location that

24 FEB 2020

smells of target odor, without sitting on any locations that do not smell of target odor. Although it appears procedurally simple and therefore practical for students and non-experts, the Reward NFS method in reality relies upon great experience and skill on the part of the trainers. Furthermore, Reward NFS often "builds in" to the dog undesirable behaviors which present long-term challenges to trainers and users. This is because the method:

(1) Attempts to teach the dog odor recognition and final response simultaneously.

(2) Makes no attempt to associate reward with odor source.

These two factors interact to bring the dog's attention to its handler during the crucial period when it should be learning to pay attention to odor. The process by which this learning occurs is as follows: During the initial trials, of course, the target odor has no "meaning" for the dog. In Reward NFS the animal is persuaded to more or less accidentally sniff the odor, normally by having the handler use hand presentations to get the dog to place its nose near the training aid. Then, hoping that the dog has "noticed" the odor, the handler manipulates the dog into a sit position, most often with a combination of verbal commands and physical prompts such as leash tugs and/or pressure on the hindquarters. In the course of this intervention, the dog's attention becomes focused on the handler and, once in the sit position, this attention to the handler is rewarded by presentation of the reward. Because the dog is rewarded while looking at the handler rather than while sniffing odor, the dog is very slow to learn that odor predicts reward (often requiring more than 150 trials). In addition, it learns that handler behavior also predicts reward. It begins to watch its handler closely during detection problems; it tends to rely upon presentations to make it sniff; and it learns much about the cues (stutter steps, etc.) a handler gives when a training aid is nearby. As a result, the dog often develops a false response tendency based on handler cues, and very much time and effort is expended in trying (often unsuccessfully) to "work out the cues". In addition to slow acquisition of odor recognition and high false response tendency, the most common deficiencies in dogs trained with Reward NFS are handler-dependence/lack of independent search behavior, weak change of behavior in response to odor (the dogs tend to simply sit when encountering odor, making it difficult for the handler to discriminate between false responses and "hits"), and poor localization (many Reward

24 FEB 2020

NFS dogs have a "fringing" tendency). All of these weaknesses are consequences of a system that encourages the dog to look to its handler for reward and guidance early in training, before the dog's behavior has come under strong control by target odor.

3. Deferred Final Response Method. The DFR method differs from the Reward NFS method in three critical ways:

a. First. During initial training of odor recognition, the final response is not required. Instead we defer teaching of the final response until later, when the dog has mastered some critical pieces of learning. On initial trials, the dog is prompted to search a given area, normally by pretending to hide the reward in that area. When the dog investigates, sniffing for the reward, and sniffs target odor instead, then the reward is provided. Thus we provide the dog with a very "clean" and simple pairing of target odor and reward, without any cues from the handler to compete with odor for the dog's attention. As a result, the dog learns to recognize odor extremely quickly. Dogs trained with DFR normally exhibit strong changes of behavior in response to target odor after five or six trials.

b. Second. DFR is a "reward-from-source" method, meaning the dog is taught that reward originates from odor source. There are many ways to provide reward from source, including simply placing the reward with the odor, but in DFR we rarely place the reward with the training aid. Instead, we "lob" the reward in from behind the dog when it is sniffing odor, so that the reward appears without any warning and falls as softly as possible directly on odor source.

c. Third. During early stages of DFR training, the role of the handler in making presentations and guiding the dog's search is greatly reduced. In fact, the handler gives the dog as little information as possible. The dog searches off-leash in a confined area, or works on-leash with an absolute minimum of influence from the handler. We are not concerned if the dog "walks" the training aid. We operate from the principle that the worst thing the handler can do in detector dog training is show the dog where the aid is by stopping the animal on the aid. It is the dog's job to stop the handler on the training aid, and if it fails to do so it learns two important lessons:

(1) No one will help it to find odor.

(2) Leaving odor is a mistake to be avoided, because it results in more work and greater delay to reinforcement.

#### 4. Overview of the DFR Training Sequence

a. The first step is to teach odor recognition by "paying on sniff" without any requirement for final response. The dog is not paid unless it is clear that it is sniffing and that it has "noticed" the smell of the training aid. Normally within one day of training and no more than ten trials the dog exhibits vigorous changes of behavior when encountering target odor. These changes include bracketing to source, perhaps "freezing" behavior, and sometimes scratching or biting (i.e., "aggression") at the source. Aggression is not desirable and efforts are made to control it, but all recent experience in the Specialized Search Dog and other dog Courses indicate that, in a focus-trained dog, a degree of aggressive responding early in training is common and does not necessarily indicate that the animal will develop into a persistent "aggressive responder".

b. During the first six to eight days of training and perhaps thirty to fifty trials, the dog works on one odor, with a minimum of handler presentations and interference, with "pay on sniff" rather than final response. Efforts are made to encourage the dog to look/focus/point at odor source, because when the dog focuses on odor it is not observing its handler and learning about handler cues. The dog is desensitized to people in the search area, and taught to ignore physical contact and interference from personnel while it is searching. At the same time, it is taught to focus on odor for two or three seconds at a time and taught to "check back" to odor on command when focus is broken.

c. Simultaneously with odor recognition training, the final response (sit) is pre-trained. The sit is not performed in "obedience" mode, and corrections are not used. Instead the dog is induced to sit with food or a reward. Ideally the dog learns to sit when it is pointing at a reward (such as a kong held by the handler) that it cannot take because it is blocked by a barrier (in this case the handler's hand enclosing the reward). The dog is never forced to sit. Instead it is kept interested in the reward until it chooses to sit voluntarily, and then it is rewarded. Initially, the use of a "SIT" command or any other cue to sit is avoided, so that the sit is not dependent on a command. Ideally, the dog perceives a blocked reward and learns to spontaneously sit in order to unblock the reward. Once the dog sits quickly and easily to unblock a reward, then we may attach a cue to the sit, such as a light touch on the dog's

24 FEB 2020

rump, or a slight tug on the collar, or even the verbal command "SIT".

d. When the dog recognizes target odor, stops on it and stares, can be made to "check back," and when the pre-trained sit is fluent, then we begin to require the animal to give the final response on odor. This stage is normally reached on day six to ten of training. Initial final response training can be accomplished in a number of different ways, but in the most straightforward method, the aid is placed in a piece of furniture at about nose height. Rather than paying on sniff, the handler cues the dog into the sit using one of the cues (tug on-leash from behind, touch on rump, verbal command "SIT") that was taught during pre-training of the sit. It is important to realize that this use of the word "cue" is not identical to the common use of the word "cue" in DoD terminology. When we speak of a "handler cue" in Reward NFS, we are referring to a piece of information that the handler gives the dog to help it sit on/find the training aid (normally the "handler cue" is a mistake or an accident). In DFR we never deliberately "cue" the dog to help it find the training aid. The dog must always find the training aid and stop on it without assistance. The "cue" in DFR is merely help from the handler in completing the final response. One way to think of it is if the dog independently detects and localizes the training aid, then it "earns" help with the final response.

e. At some point early in training, but normally after the training of odor recognition and final response on the first odor, the dog is taught to perform search exercises in new training areas (vehicles, aircraft, etc.). The handler may also begin to encourage the dog to look to him/her for help in finding the training aid (i.e., the dog is trained to accept guidance in the form of handler presentations of productive areas).

f. The dog is taught additional odors one at a time using a procedure that is directly analogous to the original pay on sniff procedure. The dog is set to work in a search area in which there is a find consisting of the new odor. When the dog sniffs the odor, it will normally show a behavior change indicating that it has noticed the strong new odor. At this moment the reward is delivered. Final response is not required. Just as in the training of the original odor, pay on sniff imprinting of the second odor proceeds very rapidly. It is not unusual for the dog to show clear odor recognition (change of behavior when encountering the new odor) within ten trials or



less. Once clear odor recognition is established, then the final response is cued on the new odor. Normally the learning of the final response in association with the new odor proceeds more quickly than with the original odor. It is not unusual for a dog to establish full proficiency on a second odor in 25 to 30 trials or less (provided they were fully proficient on the original odor). The third odor is imprinted/taught in just the same fashion, first paying on sniff, then demanding final once odor recognition is established. With each additional odor, imprinting and then establishing final response should proceed a little more rapidly and easily. Thus, although it may require 25 to 30 trials to bring the dog to full proficiency on the second odor, the third odor may require only 20 to 25, and so forth. Once the dog is certified on the basic scent-kit odors and shipped to the field, the same procedure is used in the field to teach the dog additional odors. Training of additional odors may also proceed very rapidly, so that a dog may establish certification/validation-level performance within 20 or 25 trials on a new odor.

#### 5. Liabilities of DFR

a. Above we reviewed the significant liabilities of the standard DoD (Reward NFS) method. DFR also has liabilities. It can produce certain undesirable behaviors. However, these undesirable behaviors are not as harmful and difficult to correct as the handler-dependence, weak change of behavior and localization, and high false response tendency so common in Reward NFS dogs. In a word, the kinds of problems associated with Deferred NFS are the kinds of problems we would rather have.

b. DFR-trained dogs can be excessively independent while searching, and may sometimes be reluctant to accept presentations. This shortcoming is offset by the fact that these dogs are often extremely accurate and effective when "scanning" and working independently.

c. The most common problem in DFR dogs is a tendency to stop/stand and stare at odor rather than sit. It is worth noting that this is not a functional problem from the standpoint of detecting narcotics or explosives. A distinct change of behavior followed by localization and then a stop and stare is every bit as recognizable to the handler as a sit. In fact, the DoD Specialized Search Dog Program officially authorizes the stop and stare as a final response.

24 FEB 2020

d. The first thing to realize about "stop and stare" is that it is the result of physical and psychological tension rather than disobedience. For the DFR dog, an odor source is like a magnet that draws the dog's attention. The dog orients to odor in the same way it looks at the reward, with great excitement. As a result the dog carries much more physical tension in its body than a Reward NFS dog. This tension makes the final response more difficult because, in order to sit, the dog must relax major muscle groups in its back and hindquarters.

e. The expression "stop and stare" is used to describe a wide range of difficulties with the final response, ranging from an dog that delays its sit for five or six seconds, to an animal that exhibits a classic "locked up" stop and stare, in which its body goes completely rigid. The classic "locked up" stop and stare is a comparatively rare problem with DFR dogs. More common final response issues are:

(1) Slow sit.

(2) Not completely reliable sit (stops/stands and stares sometimes).

(3) Refusal to sit unless cued somehow.

#### 6. Slow or Reluctant Final Response in DFR Dogs

a. If the dog's sit is slow or delayed, but all that is needed is to wait a few seconds for the final, we advise that you leave well enough alone. There is no compelling reason to pressure the dog for a rapid or "crisp" sit, so long as the animal stops on odor without any help from the handler, will not leave source, and sits on its own without assistance given a few seconds.

b. If the dog sometimes does not complete the final response (this may happen when the footing is difficult, or the aid is very low to the ground, or the dog is tired, etc.), then it is important not to over-react. A stop and stare error is not equivalent to critical errors like missing an aid or false responding. Keep in mind that the dog has completed the most important part of the job: it has found and indicated the drug or explosive hide. Now we just need the animal to fulfill the statutory requirement for the final response. Strong verbal corrections ("NO!") and physical corrections (jerk on choke collar) are normally not helpful because they increase the dog's stress and tension, and make it all the more difficult for the

24 FEB 2020

animal to relax enough to finish the final response. Likewise simply trying to force the dog's hindquarters down to the ground should be avoided, because it generates resistance and makes the dog lock its legs.

c. The first corrective action for a dog that stops and stares should be familiar, because it is a fundamental part of handling any DoD-trained detector dog. When the dog stops on the training aid, the handler should keep moving away from the dog and present the next location in the search area. If the dog neither leaves the training aid nor sits, then the handler should put more pressure on the dog with slight leash tension or a tug on the leash. If the dog is not actively working the odor, or sitting, then it needs to move on and actively sniff the next location. This procedure is no different than handling a Reward NFS dog, but still many handlers need to be reminded of it. In this situation, many dogs will react by completing the final because they do not want to be taken away from the aid. Some dogs will allow themselves to be taken away from odor, but then they immediately realize this was a mistake. They begin trying to cut back to it, and if they are allowed to do so (on their own; the handler does not "bounce them back" to the aid) they will complete final when they get to source.

d. If the above procedure is not effective, and still the dog stops and stares, then the next thing for the handler to try is to simply give a "SIT!" command from behind the dog. Many animals will comply. In preparation for this procedure, it is a good idea to practice and "fine tune" the dog's response to the "SIT!" command during obedience training.

e. If the dog does not complete the final response with the verbal command, then the handler can try two other types of assist. First, he/she should use the leash to administer light snaps or tugs on the choke collar, straight back towards the dog's hindquarters. If this is not effective, then the handler should try lightly tapping or pushing downwards against the dog's rump, just ahead of its tail and behind the hips. The handler should NOT push against the dogs back ahead of the hips, because this normally causes the dog to brace against the pressure. Most dogs know one of these assists for the final, or a combination of them may be most effective, and will respond by executing the sit. Once the dog has completed the final response, then the handler praises with "GOOD!" and prepares to provide the reward.

24 FEB 2020

f. The reward should be given while the dog is focused on odor, from straight behind or some other blind spot, and it should be lobbed in as softly as possible. Ideally, it goes "dead" at odor source, so that the dog can simply pick it up, rather than chase it frantically around the room. SSD trainers and other specialists in DFR sometimes arrange nets or even pillows near the training aid, or use a "spiked" tennis ball or something similar, so that the reward lands at source and stays there without bouncing. If the assist distracted the dog, then focus on the odor source should be re-established prior to reward.

g. If the sit is consistently assisted as described above, the dog's final response normally improves, and no other special efforts are required. Sometimes it may happen, however, that the dog becomes dependent upon the assist it will not sit unless it is given some cue. In this case, it is often effective to allow the dog to make repeated finds of the same training aid. This procedure removes the search element from the exercise and allows us to concentrate the dog's energy on the final response. Also, because the dog is asked to sit repeatedly in the same location, the animal's anticipation works in our favor to produce a "fluent" (relaxed, easy, prompt) sit. The first time the dog finds the aid, it is assisted into the sit and paid. After the reward is recovered from the dog, the animal is allowed to go right back to the aid. On the second indication of the aid, if the dog does not complete the final response, then it is assisted, but the dog is not paid. Instead it is praised for the sit, and then gently pulled backwards off of the training aid. (Keep in mind here that a well-trained "focus" dog will not allow itself to be easily taken away from a training aid. Instead it will fight to "check back" to the aid.) Once the dog is pulled away, it is encouraged by praising it, and then allowed to go to the aid again. If the cue is still necessary to produce the sit, then the dog is again praised for the sit verbally and physically, then pulled gently away from the aid, and allowed to go back again. The procedure is repeated as many times as necessary (within reason). When the dog eventually sits without the assist, the handler praises it and pays. Once they understand that they must sit without the assist in order to be paid, most dogs quickly improve their final response.

h. A word of caution is necessary here. Unless the dog is well-trained in "checking back," pulling the animal off of the aid repeatedly can produce some undesirable side-effects. Some dogs may become discouraged or frustrated, and begin to leave

24 FEB 2020

the odor source. If a cage is used (after a bit of basic training to establish good focus on the visible aid), then the dog is less likely to leave the visible aid. On the other hand, the dog may not leave the aid, it may instead become more tense and resistant, and begin stopping and staring more. However, the resistance may be specific to the aid that it has encountered again and again. If we move the aid to another location and "surprise" the dog with it, the animal may show one of its best unassisted sits. Similarly, if we have a session one day in which we "hammer" the sit with many repetitions, even though the dog may conclude the session looking as though it has regressed, sometimes we find that on the first aid of the next training session, the dog will give a crisp, perfect final response.

## 7. Stop and Stare in DFR Dogs

a. If the dog's sit is extremely slow, or unreliable, or if the dog has become very tense, "locking up" and going rigid on the training aid, then we must take a more patient and multi-pronged approach to improving the final response. Probably the most important part of this approach is making sure that the dog knows how to sit in order to gain access to a blocked reward. This process is referred to as "pre-training" the sit. It was mentioned briefly above, but now we will discuss it in detail.

### b. Pre-Training the Sit

(1) First, the dog is taught to sit when the handler holds a reward in the air above its head. If possible, it is better to avoid use of the verbal cue "SIT." Instead just keep the dog's attention and let it experiment with various behaviors until it hits the right one. When the dog sits, the handler gives the reward, preferably by simply handing it to the dog calmly or dropping it into the animal's mouth. The reward should NOT be vigorously thrown or bounced. With many dogs it is more constructive to begin pre-training the sit with food rather than ball/kong reward, because food produces a more manageable level of drive. In addition, in the process of taking and eating food, the dog can more easily be taught to "respect" (i.e., not bite) its handler's hands.

(2) In the next step, the reward is held lower, where the dog can reach it, but the handler "blocks" the reward by enclosing it in his/her hands. The dog can see the reward, smell it, even get nose and teeth on it, but not take it. We use the hands to block the reward rather than a physical barrier

24 FEB 2020

because most dogs respect their handler's hands. They do not "aggress" a reward that is held in the hands the way they would a reward held in a drawer. In this situation, with the reward just inches away, nearly every dog falls into stop and stare behavior very similar to the behavior we see in detection. The handler does not try to hurry the dog into the sit. Instead he/she provides time for the dog to "think," just keeping the dog's attention on the reward by moving it slightly when necessary. When the dog eventually sits, it receives the reward (i.e., is "paid").

(3) As time passes, the handler holds the reward lower and lower, trapping it against the legs or body, waiting until the dog sits and then paying the animal calmly. Once the dog is very "fluent" with this behavior, easily and quickly offering a relaxed sit in order to unblock the reward, then the handler begins to hold the reward against the wall or against furniture, teaching the dog to give the sit whether the reward is held six feet up the wall or on the ground. Low placements of the reward, like low placements of a training aid, are particularly difficult for the dog. Note: Blocking the reward by holding it against walls and furniture should be performed sparingly because the dog can confuse this gesture with hand presentations, causing a tendency to sit or "false respond" on hand presentations that will then have to be extinguished.

(4) Next the handler gives the reward to another party. The handler holds the dog on-leash while the assistant shows the dog the blocked reward, and pays the dog for the sit. The assistant begins with the reward held high, but then quickly passes through all the steps of holding it trapped against the body and then legs, and then against a wall or furniture at various heights.

(5) Eventually, the reward is not held by a person. Instead it is "trapped" or jammed between a piece of furniture and the wall, or between a car door and its frame, etc. The exact situation does not matter, only that the dog can see and smell the reward, but not touch it or take it. The moment the dog sits, then the door is pulled open or the furniture pulled away from the wall to liberate the reward. If the dog responds aggressively rather than sitting, then you wait until the dog becomes discouraged, stops scratching/biting, and sits, and then you pay. The most important factor is not whether the dog is allowed to "aggress" a reward or aid. It is whether the dog achieves some result with the aggression. With the vast majority of dogs, if aggression does not produce any result such

as opening a drawer or moving furniture or making the handler react, then alternative behavior (i.e., sitting) will quickly take over if it is rewarded. Occasionally, it may be necessary to pay the sit not by liberating the trapped reward, but instead by lobbing another reward in from behind the dog.

(6) As a last step, the fluent and relaxed sit is placed under the control of some cue. This cue can be a voice command, a tug on the leash, or a touch on the hindquarters, whatever works best with that dog, but the cue must be given from behind the dog while it is facing a blocked reward. The exercise is set up as before, with a reward trapped in a suitable location. The dog watches the reward placed, and then is allowed to move forward on-leash until it is stopped by the barrier blocking the reward. The handler gives the cue as the dog is assuming the sit position. This means that the cue does not cause the sit. The sit is voluntary. But by pairing the cue with the voluntary sit, you can gradually give the cue the ability to trigger the sit. Most importantly, the sit we obtain is the relaxed, fluent sit the dog has learned in pre-training, rather than a tense, resistant sit.

c. Re-Teaching the Final Response

(1) Once the sit is adequately pre-trained, with a cue that enables the handler to sit the dog from behind when it is facing a blocked reward, then we bring odor into the situation. We choose a location in which the dog has been extensively drilled on sitting to unblock a reward, a "trap" between a cabinet and a wall, or between a car door and its frame, etc. We place both the reward AND a training aid in the trap. We must be careful to place the reward and training aid at a height that facilitates the sit, normally at about nose height.

(2) The dog associates the particular location of the trap with sitting. It also associates a blocked reward with sitting. These conditioned associations help to overcome the dog's tendency to respond to odor by freezing and staring.

(3) The dog is allowed to see the reward and the training aid being placed in the trap. When the dog approaches and sniffs at the reward, it also catches target odor. Depending on the individual dog and the preferences of the trainers, we can then do one of two things.

24 FEB 2020

(a) Wait until the dog sits. We wait as long as necessary without giving the dog any input or cue. We watch for the sit and ignore anything else that the dog does, except that, when the dog becomes so frustrated it leaves odor, the handler may entice it back to the trap again. This process may take a very long time (up to five or ten minutes) and it may get "ugly," in the sense that the dog may stand and stare for minute after minute, or begin looking around, even leave odor and return, or it may begin scratching or biting at the trap. However, nothing produces so much learning as a problem independently solved, and if we allow the dog to choose the sit in its own time and in its own way, just a few trials can result in dramatically less stopping and staring and a faster and faster final response.

(b) Once the dog sits, then it is rewarded, not by unblocking the trapped reward, but instead by lobbing another reward in from behind. After a bit of reward-play, then the dog is immediately sent back to the exact same trap to practice the final response again. In fact, the dog is sent back to this same trap several times in a row. This is not a search exercise, it is a final response exercise, and knowing the location of the aid only helps the dog.

(4) For the second session the exercise can be moved to another location, so that the dog has to search a little before finding the trap. This will revive the animal's sniffing behavior so that on the first trial or two we can be sure that it is smelling the training aid (and reward), rather than using eyes alone.

(5) Cue the Sit. If the dog's sit (to unblock a reward) is controlled by a cue, then the trainers can also cue the sit rather than wait for it. This method has the advantage that it results in a faster sit and less "ugly" behavior like leaving odor or aggressing, but it has the disadvantage that the cue will eventually have to be extinguished, which may involve a surprising amount of repetition and work.

(6) As before, the dog is sent to a trap containing a reward and a training aid. The moment the dog sniffs, it is cued by the handler into the sit. The handler does not wait to see if the dog will stop and stare; he/she immediately cues the sit without any pause, almost hurrying the dog into the sit. Also, once the handler begins to "ask" for the sit with the cue, they make sure that the sit is obtained, even if in the process the dog loses focus on the training aid. When the dog completes



24 FEB 2020

the sit a reward is thrown in so that it lands at odor source (training aid odor + trapped reward odor).

(7) This exercise is repeated many times, sometimes leaving the trap in a familiar location so that associations with that location help the dog to sit, but moving it often enough so that sniffing behavior is from time to time re-established. Every now and again, the handler tests the dog by waiting a moment to see if the dog begins to sit before being cued. Then for the next few trials, the handler returns to immediately cuing the sit again without waiting to see what the dog will do on its own. Once we find that during the test trials the dog has begun to reliably initiate the sit without waiting for the cue, then we move to the next step.

(8) Throughout the trials described above, the dog was paid once it reached sit position whether a cue was necessary or not. Now we raise the criterion. If a cue is required to obtain the sit, we will not pay the dog. The dog is allowed to find the reward/training aid, and the handler watches to see if the dog gives the final. If not, the handler cues the sit, then praises the dog verbally and perhaps physically while in the sit, then pulls the dog by the leash away from the aid five to ten feet, and then allows the dog to go back to the trap. This procedure is repeated again and again, cuing the sit if necessary, but never paying the dog for the sit if a cue was used. When the dog finally sits on its own without the cue, we give the reward.

(9) Eventually, once the dog is very fluent with the sit when presented with reward and training aid together in a trap, then we omit the reward and present the training aid alone. We follow the rules described in the last paragraph, giving the dog only praise and encouragement if it requires the cue in order to sit, but giving the reward if the dog sits without a cue.

d. Waiting the Dog Out vs. Cuing the Sit

(1) Choice of strategy is guided by trainer inclinations and dog characteristics. If the dog has a very rigid, "locked up" stop and stare, but will not leave the aid and does not tend to aggress, then the waiting approach is often best. Attempting to cue such a dog often stimulates more tension and resistance. Instead the animal just has to be given the time to learn that stop and stare does not produce reward, but sitting does. It is not unknown to wait ten or fifteen minutes.

24 FEB 2020

(2) If the dog has a very prompt, fluent, unresisting sit when cued, and if the dog is not extremely tense when indicating a training aid, then the cued approach is likely to be quick and effective, and has the additional advantage that it will prevent the dog from aggressing the aid, leaving it, looking around, etc.

e. Use of a Cage to Contain the Training Aid

(1) Rather than the trap, the Specialized Search Dog Course often places the training aid inside a sturdy "cage" of some sort that allows the dog to see the training aid. Although being able to see the aid may decrease sniffing somewhat, visual access to the aid helps to establish and maintain focus. This is helpful because maintaining focus can be very difficult while re-training the final response, because we may leave the dog "on the aid" for long periods of time while we wait for the sit, or subject the dog to strong physical influences in order to cue the sit.

(2) The addition of visual information to the situation can have a beneficial effect on many dogs that have difficult habits when working "hidden" training aids. Dogs that are very aggressive to aids in other situations fall into staring behavior when they are caged; dogs that walk away from hidden aids in frustration stay with them when they are visible inside a cage.

(3) Initially the cage is placed on the ground in an empty corner. A few introductory cage trials are performed to establish the dog's focus in this unique situation. The dog is paid "on sniff," which may seem puzzling in view of the fact that the goal is to cure a stop and stare problem. However, a few "pay on sniff" trials will help us establish focus on the caged aid, and they won't make the stop and stare problem any worse than it already is.

(4) An assistant shows the dog the reward and pretends to place the reward on/in the cage. The dog is released from a distance of fifteen or twenty feet away. As the dog moves in to investigate the cage the assistant "fades away" slightly so that, just as the dog reaches the cage and sniffs, he/she can drop the reward in on top of the cage without the dog seeing where the reward came from.

(5) After two or three trials like this, the dog's sense of sight will assert itself. The animal will begin sniffing

24 FEB 2020

less and looking more. It may do any number of things. The dog may stop short of the cage and stare at it, or it may go to the cage and check it and then turn away or begin to look around. In response, the assistant encourages the dog to investigate the cage, often by presenting it with his/her hand, and then drops the ball in on top of the cage when the dog "checks" it. The most important consideration is to pay the animal when it is focusing on the caged aid.

(6) After several trials, when the dog's sniffing has been reduced because it has begun to look at the training aid/cage instead of smelling it, then you can "wake the dog's nose up" again by moving the cage to a new location. You can move it to another corner of the room, or you can place it inside a chest of drawers, replacing one of the drawers with the cage. In this location, the cage and training aid will be easy to find, but the dog will still have to sniff to find it. In addition, once found, there are plenty of visual cues to help the dog stay with the training aid. The dog will go to the familiar corner, find the cage is gone, and begin sniffing for it. When it finds the cage it will check the aid closely and sniff, and you can pay for this sniffing and checking. After a few trials like this, you should obtain good "focusing" and "checking back" and sniffing behavior on the cage. Now, if you withhold the reward, you should see the dog's stop and stare behavior in full force. At this point you can adopt one of the two strategies described above:

(a) If you choose to wait for the sit, then the visual cues of the training aid inside the cage will help to keep the dog with the aid while it "thinks" the problem over. In addition, the cage will protect the aid and prevent the dog from getting any result should it become frustrated and begin scratching and/or biting at the aid.

(b) If you choose to cue the sit, then again the cage will help keep the dog focused on the training aid while you use the cue. This is especially important if the dog loses focus while you are cuing the sit. Once in the sit, with a little encouragement the dog can be induced to look back at the training aid and then be paid for checking it. You assume you will have to assist the dog many times. Initially you pay the dog even if you have to assist it with the cue. Later you pay only if the dog completes the final response without assistance.

## 8. Issues with DFR Dogs

a. Disrupted Focus. In order to understand the importance of maintaining focus in the DFR dog, you must again consider the common shortcomings of the Reward NFS dog. Two of the cardinal faults of a conventionally-trained Reward NFS dog are that the animal:

(1) Tends to sit on fringe odor rather than going to source.

(2) Tends to stop working odor/sniffing after the final response.

b. These two faults, both rooted in the fact that the dog expects reward from the handler rather than from source, interact in the following way to produce final responding on handler cues rather than on odor. When the dog smells odor, it final responds and looks at the handler. If the dog is not as close to source as you desire, then the handler asks the dog to leave the final and continue to sniff/search. The dog normally does not do so effectively, because once it has smelled odor it quite rightly expects reward to come from the handler, and so it looks at the handler, its mind on visual cues rather than sniffing. The handler normally makes a hand presentation or gives some other sort of encouragement; the dog makes a token head movement while looking at the handler, moves in the direction the handler has gestured, and then immediately sits again. If the dog has moved closer to source, the dog is then paid. However, from the moment the dog first gave final, it has not done any further sniffing or processed any more odor. It has merely oriented at and responded to a series of handler cues, and then been rewarded.

c. In contrast, a DFR dog needs absolutely no encouragement to go directly to source. In addition, if the dog is well-trained, it continues to work odor and investigate source even after first final. This is the basis of the "checking back" behavior that is so valuable to the detector dog handler. When the dog "checks back," it points at, or crowds, or drives into the odor source, normally in response to some attempt on the handler's part to take it off of odor. This checking back behavior is extremely useful because it allows us to:

(1) Refocus the dog's attention on odor after it has been disrupted by, for instance, cuing the final response. This

24 FEB 2020

enables the handler to pay the dog for sniffing odor rather than looking at its handler.

(2) Ask the dog to "confirm" a find. You ask the dog to confirm by trying to pull it away from something it is interested in, either before final or after final. A well-trained DFR dog must be physically dragged away from odor and will exert strenuous efforts to get back to odor and repeat the final. This makes the dog extremely easy to read, and simplifies the problem of telling the difference between interest in a distracting odor and a change of behavior in response to a bomb or drug hide.

d. When a DFR dog has lost focus on training aids, when it no longer checks back when asked, this is normally as a result of "damage done" while teaching the final response. However, note that many dogs lose focus while learning the final and have to be "rebuilt" once the final is fluent. This is not difficult as long as the dog was taught to check back to odor prior to introduction of the final response.

(1) The first thing to do in re-establishing focus is to run a few "pay on sniff" trials. It is very helpful to have a visible training aid (in a cage) so that the dog has a visual fixation point. Next, allow the dog to find the aid again, but wait for the final response. Once the dog has completed final, then the handler can attempt a variety of different techniques to induce the dog to "check back".

(2) Stand behind the dog and wait for a few seconds, encouraging the dog verbally to "check!" Be extremely alert for a head movement towards the training aid, and be ready to pay on odor source.

(3) Exert a slight backwards pull on the dog's collar, as though to pull the dog straight back off of odor. At the moment the dog feels this traction, it is likely to "head-poke" back at the aid, and at this instant the handler or an assistant must pay by dropping the reward on source.

(4) If slight pressure does not cause the dog to check back to source, then the handler can pull harder and actually pull the dog backwards out of the sit. Praise and encourage and excite the dog and then release it to go back to source. Initially, you pay the dog for checking back to odor without demanding the sit. Later you withhold the reward until the dog checks back and then completes the second final response. (Note:

24 FEB 2020

The decision about whether it is "safe" to reward the dog on sniff without the final response depends on how fluent the dog's final response is. If the dog has a very fluent, relaxed sit, then it is normally not harmful to sometimes pay on sniff. If, on the other hand, the dog has a resistant, tense sit, then paying on sniff may quickly result in stop and stare.) If the dog completes the second final, but loses focus again, then give the slight pull (as above) to try and re-establish focus during the final. However, it may be impossible to obtain both focus and final at the same time, so alternately reward one and then the other until the dog unites them both.

(5) If the dog has completely lost focus on the aid so that none of the above produces the check-back, then the handler can attempt a hand presentation to bring the dog's attention back to the aid. Do not pay the dog while the hand is still on source. This merely rewards the dog for looking at a part of the handler's body. Instead tap on source to draw the dog's attention, and then attempt to "fade" the hand out and pay for focus on source.

(6) One trick used by the SSD Course is to place a radio with the training aid. When the dog is in final, the radio is keyed. The dog looks at source and is paid.

(7) Another trick to re-establish focus is to use a "reward system" to deliver the reward from odor source. There are very, very many of such devices, some complicated and elaborate and some very simple. In one version used by the SSD Course a training aid is placed in a box that opens towards the dog. Poised two or three feet above the aid is a reward in a PVC pipe, held there by a piece of thin bungee cord stretched from one side of the tube to the other. The reward rests on top of the bungee. Another piece of bungee cord or string is tied to the middle of the first so that if someone pulls sideways on it, the reward can slip past the first bungee and down the tube and land on the odor source. The important elements of such a reward system are that the reward is separate from odor prior to payment; that the dog is paid by someone other than the handler actuating the reward system, and that the reward lands as directly and softly as possible on odor source.

e. As a final note, keep in mind the purpose of focus on the aid. It is to make sure that the dog does not learn "handler cues" by watching the handler, and to make sure the dog can be rewarded on odor source for approaching source. If both of these conditions are met, then you are likely to produce a dog

24 FEB 2020

that shows strong independent search behavior, an obvious change of behavior, good bracketing to source before final, and a desire to check back to odor if walked or pulled off of it. If you have these elements in place, then exactly where the dog focuses while in the final response is not especially important as long as the animal does not look directly at the handler during payment. In fact, many DFR dogs learn a sort of "superstitious staring" behavior in which they do not focus on source (especially when it is high overhead and well-hidden); instead they stare generally upwards or away from the handler. This behavior still serves the most important purpose of focus on odor source. It keeps the dog from being paid for focusing on the handler.

f. Refusal to Accept Presentations

(1) Because early in training they were never encouraged to look to their handlers for any help or information, DFR dogs tend to be very independent while searching. Many of them work very effectively on loose-leash "scans," and handlers find that this is often the best way to begin a search. They make presentations only when the dog misses a productive area. Eventually, if the dog is unable to make the find independently, or when it becomes tired and needs some guidance and encouragement, then the handler becomes more active and supplies more guidance.

(2) If a DFR dog is excessively independent and will not accept its handler's presentations, this is normally because the dog has simply not yet learned that the handler can be a help in finding the aid. (Note that this is to some extent deliberate. You do not want the dog to learn to "use" presentations by its handler until late in training, after it has already become completely independent, aid-focused, and self-reliant.) In working with such a dog, the two most important factors are the following: the handler should give few presentations, and the handler must make sure that these presentations are productive from the dog's standpoint.

(3) Set up a search problem with one training aid. Begin the search with the dog working independently, without presentations, but stay away from the area where the training aid is hidden. Wait until the dog tires substantially, and becomes more receptive to the handler's influence. Then move the dog into the area of the training aid and make a careful presentation in a productive area near the training aid, so that the dog catches the odor and completes the find and receives

24 FEB 2020

reward. Repeat this sort of search exercise a few times. Run the dog on a long problem without any possibility of finding the training aid until the dog wears down somewhat, then take the dog into the vicinity of the training aid and make a presentation or two that put the dog "into odor". The animal will quickly learn to look for presentations, because they indicate an area in which odor can be found. Once the dog becomes very receptive to that initial presentation, then the handler can begin carefully adding a few more presentations here and there, very gradually building up the number of presentations the dog will eagerly accept before finding the training aid.

(4) When teaching the dog to accept high presentations, it is especially important to make sure that the first few presentations are productive for the dog, that they help the animal find odor. Otherwise the dog quickly learns to merely rear up against anything that is presented, but without sniffing.



**This Page Intentionally Blank**

**TAB G4**

E-Collar Training

**Table of Contents**

<u>IDENTIFICATION</u>	<u>TITLE</u>	<u>PAGE</u>
<b>PARAGRAPH</b>		
1	Introduction.....	G4-1
2	Use.....	G4-1
3	Techniques.....	G4-2

1. Introduction

a. Electronic/electric collars (E-collar) are devices that deliver a high-voltage, but very, very low-amperage electric stimulation to the skin of the dog's neck through electrodes. They are operated remotely by means of a hand-held (transmitter) on which there are intensity settings and buttons that trigger continuous or momentary stimulation through the collar/receiver. Some E-collars add beeps and tones (markers) that aid the dog in understanding what is required of it. This electrical shock is like a static electrical discharge from the carpet; it is similar to, but much weaker than, the shock delivered by a livestock fence. This shock may be uncomfortable, but it does not cause injury, because injury is a result of the amperage of an electrical shock, not the voltage.

b. E-collars are common and well-accepted instruments, not only among the pet-owning American public, but also by communities such as the Retriever Field Trial Organizations that participate in the American Kennel Club (AKC) Licensed Hunt Test and the AKC Licensed Field Trials. The E-collar is primarily used in the training of the Specialized Search Dog (SSD) and the USMC Improvised Explosive Device Detector Dog (IDD) and is also used in other federal agencies and many state, county, and city law enforcement agencies.

2. Use. **When used correctly,** electronic collars provide the ability to deliver electrical stimulation that can be finely-calibrated to the individual dog's level of sensitivity, over long distances and with very precise timing. **However, electronic collars demand a very high level of technical knowledge, ability and experience from the handler, for a number of reasons:**

24 FEB 2020

a. Because the onset and offset of electrical stimulation is so precise and "clean," the electronic collar magnifies the effect of any errors of timing on the handler's part. However, this ability to communicate with the dog instantly prompts "recency of experience" which can dramatically reduce learning time. This immediate communication can be a double edged sword, meaning this same instant communication with the dog is much less forgiving if used incorrectly. It is for this reason that initial E-collar training should be done with an established MWD Team. If this tailored approach is followed, the benefits of the E-collar will be dramatically enhanced, significantly diminishing mishaps and training time.

b. Without proper introduction and training to show the dog how to respond to this new form of communication, the electrical stimulation from the collar produces something like a startle response and the dog throws its head up or bends its neck and perhaps jumps forward or up, precisely as you would do if you were momentarily shocked on the back or neck by a prank buzzer. For this reason a familiar reference point must be made when introducing the E-collar to the dog. This is completed by using already known correction devices such as leash corrections utilizing traditional type training collars. Paring the leash correction with the E-collar in low drive exercises with low E-collar stimulation makes for a smooth transition.

### 3. Techniques

a. The same principles and techniques utilized to introduce leash and conventional type correction devices to the dog (such as choke or pinch collars) also apply to E-collar introduction. Therefore, the dog must be properly trained through this introduction phase. Simply put the E-collar must be recognized as a communication device first and not a punishment device. It is understood that the E-collar is aversive in nature just as choke or pinch collars are; however, it is the use of motivation and reward systems that will allow the dog to accept this new form of communication during the introduction phase of E-collar training.

b. Just as the dog must learn to accept a leash correction with traditional type training collars, the same is true for the E-collar. A form of escape training is used during E-collar training; however, this is not unique to the E-collar. Just as the dog is trained to avoid (escape) a quick and sharp jerk of a leash correction, the dog is taught to (escape) the stimulation of the E-collar. Once the dog has learned to avoid the

24 FEB 2020

correction this behavior is shaped and channeled precisely utilizing the same motivators in traditional training (verbal praise, food and or prey rewards). It is important to understand that the E-collar is like any tool which can be misused just as traditional training collars can. In many cases, conflicts during training can be dramatically reduced because of the consistent and precise nature of the E-collar correction. Once again though this all has to do with proper introduction to the device.

**TAB G5**

ODOR Imprinting

**Table of Contents**

<u>IDENTIFICATION</u>	<u>TITLE</u>	<u>PAGE</u>
<b>PARAGRAPH</b>		
1	Reference.....	G5-1

1. Reference. Imprinting process is described in the DFR process discussed in tab G3, paragraph 4.f.

**Tab G6**

Basic Skills Training

**Table Of Contents**

<u>IDENTIFICATION</u>	<u>TITLE</u>	<u>PAGE</u>
<b>PARAGRAPH</b>		
1	Obedience Commands.....	G6-1
2	Obstacle Course.....	G6-8
3	Gunfire.....	G6-9

1. Obedience Commands. Give voice commands sharply, crisply and in unison with the corresponding hand command. After the handler/dog team becomes proficient, you may give the commands and/or gestures independently. The commands start with the instructor, directed at the handler, (e.g., Instructor, "SIT DOG, COMMAND"; Handler, "SIT" with a hand gesture.)

a. Obedience Commands Beside the Dog. Teach all basic obedience commands first on-leash with the dog at the handler's left side. These commands and correct responses start and end with the dog in the HEEL/SIT position.

(1) Heel. The initial command and response is "HEEL." There are two heel positions for the dog, one is for marching and the other is for the stationary HEEL/SIT. Whether marching or in the HEEL/SIT position, ensure the dog's right shoulder is even with the handler's left leg, and the dog's body is parallel to the handler's body. The dog should not forge ahead or lag behind.

(2) Give the verbal and manual "HEEL" when the handler starts forward movements, changes direction, and at one pace before coming to a halt. Give the hand gesture by slapping the left leg with the open left hand, while commanding "HEEL." When called to attention, give the command HEEL as the left foot strikes the ground. At the command "Forward MARCH," give the command "HEEL" with the first step forward. If a dog lags behind, coax the dog into the heel position (NOT JERKED) by patting the left leg, snapping the fingers, calling the dog's name, or verbally encouraging the dog. On movements to the left, give the command "HEEL" after the handler's right foot begins to pivot. This prevents the dog from blocking the pivot movement. On movements to the right and the rear, give the

24 FEB 2020

command "HEEL" as the handler pivots. The dog can then assume the heel position before the movement is completed.

(3) HEEL/SIT. After the dog learns to walk in the heel position, it must learn to HEEL and then SIT in the heel position. Once the dog has learned the separate responses of HEEL and SIT, the next step is to teach the dog to SIT automatically in the heel position when stopped without further command.

(a) When the instructor gives the command "SIT DOG, COMMAND", the handler gives the command "SIT," while grasping the leash several inches above the choke chain with the right hand. Place the palm of the left hand over the dog's hips with the fingers positioned at the base of the dog's tail, apply upward pressure on the leash while pushing down on the dog's hindquarters. As the training progresses, the dog should no longer require physical assistance.

(b) In learning the command SIT, the dog may get slightly out of position. If this occurs gently reposition the dog. Every time the dog assumes the correct position praise the dog. Take care not to make praise excessive, since this may cause the dog to break position.

(4) Down. When the instructor gives "DOWN DOG, COMMAND," and when the handler gives the command "DOWN," the dog must promptly lie parallel to the handler with its right shoulder in line with the handler's left foot.

(a) The handler introduces the command "DOWN" when the dog is in the HEEL/SIT position. Give the hand gesture along with the verbal command. Some dogs may resist going down because it places them in an unnatural position. Therefore, use caution since the dog could bite the handler. First, the handler bends down and grasps the leash just behind the snap or the choke chain ahead of the snap depending on how much space is needed to apply downward pressure on the leash. Then, while giving the DOWN command, apply pressure firmly toward the ground until the dog lies down. If the dog assumes the DOWN position without resistance, the handler should praise verbally before returning to the position of attention. Take care not to make praise excessive; this may cause the dog to break position. Use the command "STAY" before returning to the position of attention.

24 FEB 2020

(b) To place a resisting dog in the DOWN position, the handler kneels down and grasps the leash just behind the snap with the left hand; then place the right arm behind the right front leg and grasp the left front leg about six inches above the foot. While pressing down on the leash, command "DOWN" and push the front legs forward until the dog is in the DOWN position.

(c) Once the dog has learned the DOWN command, you may need to correct the dog's position. If this occurs, give the command "SIT"; and after the dog sits, repeat the down process. Take care not to move the left foot while correcting the position since the dog is trained to line up on the left foot/leg.

(5) Stay. The stay command is introduced while the dog is in the HEEL/SIT position and used for any position you commanded the dog to assume. Ensure the hand gesture is distinct, decisive, and executed in the following manner:

(a) Lock the left arm at the elbow.

(b) Turn the hand until the palm faces rear and open it until the fingers are extended and together.

(c) Move the extended, locked arm forward until the arm and body make an angle of approximately 45 degrees.

(d) Bring the flattened palm smartly straight back toward the dog's face, stopping immediately in front of the nose.

(e) Drop the arm directly back to the left side.

b. Commands Away From the Dog. Once the team is proficient in movements with the dog in the heel position, progress to movements and positions with handler and dog separated by varying distances.

(1) "End of the Leash, Move". After giving this command, the handler gives the hand and voice command "STAY," then takes one step forward, right foot first, and pivots 180 degrees left to face the dog. As you make the pivot, transfer the leash from the right hand to the left. At the completion of the pivot, place the left hand in front of the belt buckle with the loop of the leash over the left thumb and the fingers curled around the leash as it continues down past the palm of the left hand.



24 FEB 2020

(2) "STAY" at EOL. When at the end of the leash with the leash in the left hand and in front of your belt buckle, give the command "STAY" (verbal and hand).

(a) With fingers extended and together, bring the right hand to shoulder level, palm toward the dog.

(b) Push the palm toward the dog's face smartly, commanding "STAY".

(c) Smartly drop hand and arm directly to the side.

(3) "Return to the HEEL Position, Move". After you give the verbal and manual command of "STAY," step off with the right foot to the right flipping the leash to the left so that the leash rests on the right side of the dog's neck. This will keep the leash from hitting the dog in the face. Walking in a small circle around the dog to the rear returning to the dog's right side. Take up the slack in the leash and transfer it back to the right hand. Praise the dog verbally and physically.

(4) "DOWN" at EOL. With the dog in the HEEL/SIT position, give the command "STAY" and move to the end of the leash changing the leash to the left hand. Take one step forward with the right foot and grasp the leash about six inches from the snap. Exerting pressure downward on the leash, verbally command "DOWN." When the dog is in the DOWN position, give the command "STAY" and bring the right foot back to the starting position. At the point when the leash pressure is no longer needed, introduce the hand gesture for down. Lock the elbow, extend the fingers and rotate the arm in a full circle to the rear, until the arm is at shoulder level and parallel with the ground, palm down. While the arm is making the circle, give the verbal command "DOWN."

(5) "SIT" at End of Leash. The command "SIT" is introduced when the dog has learned the command "DOWN/STAY." With the dog in the DOWN position, the instructor gives the command "SIT DOG, COMMAND." The handler steps forward one step with the right foot, grasps the leash about 12 inches above the choke chain, exerts upward pressure on the leash and gives the command "SIT." When the dog sits, give the command "STAY", give verbal praise, then return to the original position. When the dog is sitting, without using leash pressure, introduce the manual gesture as follows. Extend the fingers of the right hand and lock the elbow. Turn the flattened palm toward the dog. Smartly lift the extended arm to the horizontal shoulder

24 FEB 2020

position and command "SIT." Drop the arm smartly back to the side. Praise verbally, not excessively.

c. Commands and Moves for the Handler/Dog at End of Leash

(1) Circle Dog. The handler gives the command "STAY" and steps off with the right or left foot depending on the direction of the command. As you make the circle around the dog, flip the leash around the dog's neck to the opposite side of the beginning direction of the circle. Take care during the circle movements not to stretch the leash taut causing the dog to break position.

(2) Step Over the Dog. The same procedures apply as the Circle Dog, with the exception that the dog is in the DOWN position so that the handler can step over conveniently.

(3) Straddle Dog. The handler gives the command "STAY," steps forward with the right foot, lowers the leash, steps over it with the left foot, and proceeds to straddle the dog that is in the DOWN position. When the handler gets to the rear of the dog, to the left 180 degrees, step over the leash with the left foot, straddle the dog, and return to the end of the leash. As the handler makes the turn to face the dog again, he/she returns the leash to the left hand.

(4) Recall Dog. With the handler at the end of the leash, the instructor commands, "RECALL dog, COMMAND." The handler gives the verbal and manual command of "HEEL" and if necessary calls the dog's name to get its attention. If the dog is reluctant to come on command, you may have to apply slight pressure on the leash with some verbal coaxing to get the dog to come. As the dog is returning, take up the slack in the leash and guide the dog into the heel position.

d. Military Drill. In all formations, the dog remains in the HEEL/SIT or marching heel position.

(1) Attention. The position of attention is a two count movement. At the preparatory command "SQUAD," the handler comes to attention. At the command "ATTENTION," the handler takes one step forward with the left foot and gives the command "HEEL." When the right foot is brought forward even with the left, the two-count movement is complete and the dog should be in the HEEL/SIT position.

24 FEB 2020

(2) Parade Rest. At the preparatory command of "PARADE," the handler gives the command and manual gesture "DOWN." At the command of execution "REST," the handler gives the command and manual gesture "STAY," then steps over the dog with the left foot straddling the dog. The handler places his/her left hand behind his back. To resume the position of attention, use the preparatory command "SQUAD," at which time the handler gives the command "STAY." At the command of execution ("ATTENTION"), the handler steps back over the dog and gives the command "HEEL."

(3) At Ease/Rest. When given the command, keep the left foot in place while the dog remains in the HEEL/SIT position.

(4) Fall Out. When given the command, the handler leaves ranks and puts the dog on break.

(5) Fall In. The handler and dog resume their previous position in ranks at the position of attention with the dog in the HEEL/SIT position.

(6) Right Face. "RIGHT FACE" is a four-count movement. At the command of execution "FACE," the handler takes one step forward with the left foot, commands "HEEL" and pivots on the balls of both feet 90° to the right. They then take one step forward with the right foot, bringing the left foot even with the right. The handler then commands "HEEL" and returns to the position of attention.

(7) Left Face. "LEFT FACE" is a four-count movement. At the command of execution "FACE," the handler takes one pace forward with the right foot, pivots on the balls of both feet 90° to the left and commands "HEEL." They then take one step forward with the left foot, bringing the right foot even with the left and returning to the position of attention.

(8) About Face. "ABOUT FACE" is a four-count movement. At the command of execution "FACE," the handler takes one step forward with the left foot, commands "HEEL," then pivots 180° and gives the command "HEEL." On the completion of the pivot, the handler takes one step with the left foot bringing the right foot beside it, and returning to the position of attention.

e. Drill Formations. Four drill formations are used to teach basic obedience. Each is designed for a specific purpose, yet is flexible enough for other phases of training. For safety, allow intervals of 15 feet between dog teams during

initial obedience training. When handlers can control their dogs, you may reduce this distance.

(1) Circle Formation. In this formation, the dog can learn the heel position. It requires walking at the handler's side without sharp turns. The instructor is usually in the center of the circle for better observation of the dog teams.

(2) Square Formation. This formation is excellent for teaching the dog the heel position when the handler is making sharp turns.

(3) Line Formation. The line formation is used effectively during basic, intermediate and advanced obedience.

(4) Flight Formation. The flight formation is introduced after the dog teams demonstrate proficiency in the circle, line, and square formations. Use it for moving groups of dog teams from one location to another.

f. Intermediate Obedience. This training differs from basic obedience in distance only. In intermediate obedience, use the 360-inch leash instead of the 60-inch leash. Once the 360-inch leash is attached, the handler should start at the same distance as with the 60-inch, then gradually increase distance and time spent at the end of leash. During intermediate obedience, if the dog fails to perform any specific command, the handler should walk back to the dog and put the dog in the desired position. While approaching, give the command "STAY," only if the dog starts to break position. After making the correction, use shorter distances for later trials. Never run back to the dog or make threatening gestures. This may make the dog break position and run.

g. Advanced Obedience. Advanced obedience allows the dog to learn to execute commands given at a distance, off-leash. To begin off-leash training, the handler must execute basic command and movements with the dog at his/her side. (This gives the handler an opportunity to test the dog's reliability, and revert to using the long or short leash to correct deficiencies.) This obedience training at the handler's side should continue until the handler believes the dog will perform among other teams without hostility. As training progresses, the handler moves out in front of the dog a short distance and gradually increases the distance and time periods away from the dog. The dog's performance will determine distance from the handler. Normally, 50 feet is the maximum distance. When the handler moves back to

the dog, the handler should circle around and step or jump over the dog. These movements teach the dog to remain in position until otherwise commanded. This stage of training should require only a minimum number of corrections. If the dog does not respond correctly and consistently to commands, the handler must return to the preliminary off-leash exercises and repeat them as often as required.

## 2. Obstacle Course

a. General. As an MWD team becomes proficient in basic obedience and associated tasks, introduce the obstacle course for the purpose of building the dog's confidence in negotiating similar obstacles the dog may encounter in the field. The obstacle course also conditions the dog and builds handler confidence in the dog's abilities. The determining factors for length of time spent and frequency of obstacle course use include dog's age, physical condition, and weather conditions.

b. Obstacle Course Training Procedures. The dog jumps or scales obstacles on the command "HUP," and when commanded, returns to the heel position. As in other training, first teach the dog to complete exercises on-leash. This allows the handler more control while guiding the dog over obstacles. As the dog's proficiency increases, train the dog off-leash. A dog may hesitate to jump over a hurdle. It is best to use a hurdle with removable boards and lower it so the dog can walk over it. Exerting pressure upward on the leash will cause the dog to balk or hesitate. When the hurdle is lowered, the team approaches it at normal speed, and the handler steps over it with the left foot and commands "HUP." If the dog balks, the handler helps it over by coaxing and repeating the command "HUP." After crossing the hurdle, the handler praises the dog, and gives the command "HEEL." As the dog progresses, add boards until attaining a height of three feet. Thereafter, when the handler is two paces from the hurdle, give the command "HUP." Instead of stepping over, the handler passes around to the right of the obstacle while the dog passes over it. (Allow more than two paces from the hurdle if necessary.) As the dog's front feet strike the ground, the handler commands "HEEL," adjusting the distance in front of the dog so there is room to recover from the jump and assume the heel position. Immediately after the dog is in the heel position, give praise. Vary hurdle procedures somewhat for the window, scaling wall, catwalk, and stairs. For the window, the handler must transfer the leash from the right hand to the left and throw the leash through the window catching it on the other side. If the dog hesitates, put the front feet in the

24 FEB 2020

window and coax the dog through. For scaling the wall, the dog must have more speed on approaching and you must give the HUP command sooner. Adjust the wall to the dog's abilities during initial training gradually increasing the incline. For the catwalk, the handler may have to guide the dog onto it and steady the dog's balance while it crosses. The dog must walk up and down the stairs. If wet, remove the water from the stairs prior to use. The handler may have to walk over the steps with the dog if it hesitates.

3. Gunfire. A well-trained patrol MWD reacts in a neutral way to gunfire, meaning that it is neither frightened nor aggressive. For both handler safety and mission effectiveness, in almost every case the best thing for the dog to do is to continue doing whatever it was doing before gunfire or explosions, and be ready to obey the next command. If, on the other hand, the dog becomes extremely excited and aggressive under gunfire or detonations, this response is highly dangerous for handler and dog. However, this mission requirement is problematic, because the vast majority of MWDs have already been taught prior to procurement to become excited and look for someone/something to bite when they hear gunshots.

a. If MWD trainers attempt to teach a dog not to become excited under gunfire by using strong corrections to compel the dog to remain in a sit or down or heel position during gunshots, this procedure can and often does "back-fire" in two ways. We can inadvertently teach the dog to be afraid of gunshots (because they become associated with corrections and pain), or we can teach the dog to bite the handler.

b. Normally, the best approach to teaching a dog to behave calmly under gunfire is counter-conditioning the gunshots with ball reward.

(1) In the initial procedure, dog and handler are placed at about 100 yards from an assistant with the weapon. The assistant is protected in some way in case the dog runs to him/her and attempts to bite. The handler throws the ball across the field and sends the dog in pursuit, and two or three gunshots are fired while the dog chases, but before it picks up the ball. Then the shots are fired after the dog picks the ball up and is returning to the handler. Next, shots are fired while the dog is close to the handler and moving about with the ball in its mouth. Then shots are fired after the handler has commanded the dog to release the ball, while the dog is waiting for the next throw. In the next stage, the dog is asked to

24 FEB 2020

respond to simple commands like sit, down, and heel while occasional shots are fired. Eventually, the dog is required to sit at heel with the ball out of sight in the handler's pocket while a series of shots is fired at 100 yards distance. After each series the dog is rewarded with a throw of the ball.

(2) In the next phase, the assistant/gunshots are gradually brought closer. The dog sits at heel and in attention while the shots are fired nearby. If it attempts to break position, it is leash-corrected. When it holds position and maintains attention, it receives ball reward. When the dog is proficient in this skill, then the handler begins to hold the weapon and dry-fire it while the dog remains at heel. Eventually, the handler heels the dog to the gun lying on the ground, picks the gun up with the dog at attention in heel-sit position, fires a series of shots, puts the gun down, heels away, and then rewards the dog. Eventually ball reward is provided less and less often, until finally the dog no longer needs any more than praise reward.

(3) Trainers must keep in mind that loud gunshots and heavy concussions hurt, and cause injury to hearing organs. In addition, dogs appear to be especially sensitive to muzzle blast. Therefore, attempts should be made to protect the dogs' ears, and to place them out of muzzle blast and far enough away from the weapons fire to meet local safety standards.

**TAB G7**

Patrol Dog Training

**Table of Contents**

<u>IDENTIFICATION</u>	<u>TITLE</u>	<u>PAGE</u>
<b>PARAGRAPH</b>		
1	Controlled Aggression.....	G7-1
2	Agitation.....	G7-2
3	Control.....	G7-3
4	Scouting.....	G7-8
5	Scouting Problems.....	G7-9
6	Maintaining Proficiency.....	G7-9
7	Security Problems.....	G7-9
8	Building Search.....	G7-11
9	Building Search Training.....	G7-11
10	Decoy Techniques.....	G7-14

1. Controlled Aggression. With exception of detection training, controlled aggression is the most intricate aspect of military dog training. Supervisors must ensure that each dog is trained and maintained at maximum proficiency.

a. Attack "GET'EM". Give the command only once. Give further encouragement if necessary. During on-leash agitation, the handler must maintain position and balance by spreading the feet at least shoulder-width apart, one foot slightly forward of the other. Flex the knees and bend slightly at the waist. While extending the arms, unlock elbows. Not following this procedure could cause the handler to lose balance and cause serious injury to another handler or dog.

b. "HOLD'EM". Give command in an encouraging tone of voice while the dog is biting. If the dog releases the bite, repeat the command "GET'EM," then repeat "HOLD'EM."

c. "OUT". Give this command to cue the MWD to cease attack. A properly trained dog will release the bite and on receiving the command "HEEL" return to the handler. Upon successful completion, the handler must physically and verbally praise the dog. If the dog does not release the bite, the handler should wait three seconds and repeat the "OUT" command or command "NO-OUT." If the dog does not release after the second command, the handler should repeat "NO-OUT" and apply a physical correction.  
**NOTE:** The dog must know the task before using the physical



24 FEB 2020

correction! You can teach the "OUT" command before the dog is actually biting the wrap. Do this with end of leash agitation. The handler should give the command "OUT, HEEL" and use the leash to guide the dog back to the heel position. The handler must physically and verbally praise the dog when it ceases aggression.

d. "STAY". A properly trained MWD will remain in the stay position until you give another command. During controlled aggression exercises, use the command "STAY" to notify the agitator that you are ready for exercise initiation. You may find the DOWN position helpful in preventing some dogs from breaking position.

e. "WATCH'EM". Given in a very suspicious tone of voice to put the MWD on guard. If during agitation, the dog loses interest, repeat the command.

## 2. Agitation

a. Agitator's Role. The agitator plays an important role in agitation exercises; therefore, thoroughly instruct persons acting as agitators on what to do. As an agitator, you may use a supple switch, a burlap bag, an arm protector, or a rag to provoke the dog without actually striking him. The dog's level of aggression will determine the need for using such training aids. The agitator's actions should replicate actions of real life subjects, the dog may encounter. The dog is always the winner and never backs down.

b. Aggressiveness. To determine the degree of aggressiveness or develop aggressiveness of the dog, conceal the agitator upwind of the dog team. The handler, while maintaining a safety leash, approaches the area concealing the agitator. The agitator will attempt to attract the dog's attention through normal suspect/intruder actions. Weaker dogs may require the agitator to slightly increase movements and/or make additional noise to gain the dog's attention. Meanwhile, the handler must watch the dog closely to provide timely assistance by encouraging the dog in a low suspicious voice, to "WATCH'EM." When the dog detects the intruder, the handler must encourage the dog immediately. If the dog shows no interest, the agitator should show himself/herself and move away suspiciously as the team gets within ten feet.

c. Under Aggressive. This type dog will fail to exhibit interest in the agitator even as they move away suspiciously.

24 FEB 2020

To develop aggression in these dogs, use the chase method. The agitator provokes the dog. As the dog shows aggression, the intruder will run away while continuing to make noise, while the team gives chase. After running twenty yards or so, the agitator will throw up an arm to indicate the direction they intend to turn. The agitator will turn in that direction and the team will turn in the opposite direction. The handler should exercise care not to jerk the dog off the chase, causing an unintentional correction.

### 3. Control

a. Building Control. To build control, give the dog "STAY" in the HEEL/SIT position and have the agitator move in from a distance of approximately twenty feet. The agitator may use a play rag, puppy tug, or arm protector. The agitator should approach the dog team in a manner that arouses the dog's suspicion. The handler should give the dog the STAY command and reinforce the command as necessary. The agitator will then retreat back to the starting position and cease movement. The handler should physically and verbally praise the dog. If the dog breaks position, the handler should command "NO-STAY", guide the dog back into position and repeat the command stay. If the dog continues to fail the STAY command, the handler must adjust the severity of the corrections to meet the level that will effectively change the dog's behavior. Once the dog is proficient in this scenario, the agitator will move in closer to the dog team and act in a more suspicious manner thus increasing dog stimulus to aggress. As the dog becomes proficient at this level, introduce the wrap and command the dog to bite. Use the same process to train the dog to release the wrap as you did in the initial scenario. You may need to increase the level of correction or revert to the previous method. If the dog fails to progress at this level, return to the initial scenario.

b. Commands of "OUT" or "NO-OUT". After the dog demonstrates proficiency in biting and holding, the agitator can hold the rag/protector. The handler will command "OUT" or "NO-OUT" when the agitator ceases movement. If for any reason the intruder is hurt or bitten, they should signal the handler by raising the free arm above their head. The handler should immediately give the "OUT" command and physically gain control of the dog.

c. False Run (MWDs Trained Under the Out and Guard Method--FIELD INTERVIEW)

(1) The field interview is a practical replacement for the traditional false run and designed to demonstrate the MWD's ability to be tolerant of non-aggressive movements or situations dog teams can be exposed to throughout their tour of duty. Through this training exercise it enables the handler to gain complete control over the MWD while subjected to various non-suspicious actions by a subject. As the dog's proficiency increases, this exercise will be conducted off-leash.

(2) Training Procedure. Put the dog in the HEEL/SIT or DOWN position and give the "STAY" command. The subject, wearing the arm protector, starts at a distance anywhere from 15 to 100 feet from the dog team. MWD proficiency levels of each dog trained in this exercise scenario will determine the start distance for this portion of the exercise. Once the distance has been determined, the subject will start off by facing the dog team in a non-suspicious manner and will walk towards the team by taking an indirect route. The purpose of this type of movement is designed to simulate an individual who upon initial contact or observation is non-threatening to the dog team, others or resources. As the subject reaches the dog team's location, the subject reaches out (using the wrap protected hand first) and simulates shaking the handler's hand and engages the handler in a normal conversational tone of voice. After the non-threatening verbal interaction between handler and subject, the subject simply turns and walks away from the team. Again, the subject's intension/movements are non-threatening towards the dog team as they depart. Throughout all stages of this exercise the dog must remain in the HEEL/SIT or DOWN position and should not show any signs of aggressive behavior towards the handler or subject. Handlers and trainers should use caution not to misinterpret the dog's natural behavior to be interested or curious of the person, as they move closer towards the team as aggressive behavior. Some dogs may attempt to break the heel position as the subject approaches just because they are simply interested in a non-threatening sense of the approaching individual. Should a dog show this type of behavior and it is determined, as non-aggressive behavior the handler must reinforce the HEEL command, ensuring the dog returns and stays in the heel position. If the dog stays and doesn't exhibit aggressiveness, give the dog lavish praise. If the dog breaks position, correct it immediately and repeat the exercise. During repeat exercises, as the dog shows progress the subject should now take a more direct route towards the dog team. Take care to let the dog have a bite at irregular intervals to keep the dog from becoming too frustrated, and as an indirect form of praise. Correction must not be too harsh. Training in "STAND-

24 FEB 2020

OFF" and "FALSE RUN" phases can be very difficult, especially for dogs with a high fight drive. Dogs demonstrating a high proficiency rate for this particular exercise will naturally have the distances and time ratios of dog team/subject interaction varied. Dogs with a lower proficiency rate for this exercise will need specific distances and time ratios closely monitor and controlled to build the MWD's proficiency level for this exercise.

d. Pursuit and Apprehension. Used to teach the dog, on command, to pursue, bite, and hold an individual.

(1) Training Procedure. Proficiency in all phases of obedience and timely response to commands is required prior to starting controlled aggression training. Begin with the MWD in the heel position off-leash and give the command "STAY." To begin the exercise, the subject should stand or move around suspiciously at a distance of 40 or 50 feet. Prior to releasing the dog the handler will give a warning order "*Halt or I will release my dog,*" (**NOTE:** Refer to your unit SF operating instructions for exact verbal challenging procedures/instructions.) and warn bystanders to cease all movement. When the handler commands "GET'EM," the dog should pursue, bite and hold the subject until commanded to release from the bite. The handler follows the dog as closely as possible. If the subject stops or indicates surrender, the handler will immediately call the dog off the pursuit (stand-off). If the dog makes contact with the subject, the handler will call the dog "OUT" once the situation is under control. **DURING TRAINING ONLY**, when the dog is biting, the handler provides encouragement and commands "HOLD 'EM." After a short struggle, the subject ceases movement, and the handler commands "OUT". Give praise when the dog returns to the heel position. There may be times were the dog will release from the bite, but hesitates in returning to the handler. Should this be the situation the handler will use verbal encouragement to refocus the dog's attention back to the handler. As the handler gains the dog's attention and the dog is returning to the heel position, the handler should cease verbal encouragement/praise until the dog is in the heel position.

(2) Training Realism. Conduct training in the dog's working environment when possible. Training problems must replicate "real-life" scenarios as much as possible to include the frequent use of hidden arm protectors.

e. Search of a Suspect

(1) Search apprehended personnel as soon as possible. In most instances, it is best to have another security forces person conduct the search with the dog team as back up. If no other police personnel are present, the handler may search the suspect with the dog in the GUARD position. Ensure the dog can observe the agitator/suspect at all times.

(2) Training Procedure. The handler will position the suspect six to eight feet in front of the dog, facing away from the dog. Prior to the search, place the dog in either the SIT or DOWN position and inform the agitator/suspect not to make any sudden or aggressive movements or the dog will attack. The handler gives the dog "STAY," then moves forward (right foot first) to search the agitator. Do not pass between the agitator/suspect and the dog. After searching both sides, the handler positions themselves directly behind the suspect. If the dog attempts to bite again or shows undue interest in the agitator/suspect, issue an immediate correction. When the dog returns to the proper heel position, give lavish praise.

f. Re-Attack. During a search, the MWD must learn to re-attack. If, during the search, the agitator/suspect attempts to run away or attack the handler, the dog must immediately pursue and bite and hold the agitator without command. In the early stages of or periodically during proficiency training, the handler may have to command "GET'EM." Excessive training in this area may result in a dog anticipating the moves of the agitator/suspect, causing loss of control by the handler.

g. Escort. After apprehending and searching a suspect, you may find it necessary to escort the apprehended individual out of the immediate area to a vehicle. After recalling the dog to the heel position, directly behind the suspect, the handler takes control of the suspect by placing their hands on the suspect's shoulder and escorting the suspect. The dog may heel on the handler or slightly forward on the side of the decoy to ensure an effective escort.

h. Stand-Off

(1) The purpose of the stand-off is to develop control needed by the handler to call the MWD back from a bite and hold command.

(2) Training Procedure. The agitator moves toward the dog acting suspiciously. At a distance of four feet, the agitator turns and runs. When the agitator gets about thirty feet from the team, the handler commands "GET'EM." When the agitator hears the command, they should stop and cease movement. The handler commands "OUT" and, if necessary, "NO-OUT". After the dog "OUT"s, the dog must "SIT", "DOWN", or "STAND" within the immediate area of the agitator.

i. Gunfire and "COVER" Command. The primary purpose of gunfire training is to condition the dog to perform all required tasks satisfactorily when gunfire is introduced to the scenario. The dog should not react aggressively, unless commanded by the handler, nor should it display an avoidance behavior toward gunfire. Training should be conducted both with the handler and agitator/suspect firing the weapon individually and together depending on the various stages of training; however, gunfire associated with agitation or bite training should be kept to an absolute minimum, and then only to determine if the dog still performs satisfactorily in the presence of gunfire.

(1) Training Procedure. Under no circumstances will a dog be backed down or defeated in gunfire training. Conduct gunfire training using only authorized blank ammunition. Ensure the muzzle of the firearm is always pointed in a safe direction.

(2) Conduct Gunfire Training. It is best to use a small caliber weapon, casually and intermittently. Begin initial gunfire training from a distance of at least 70 yards and include it in all phases of training. As the dog performs satisfactorily, move gunfire gradually closer to the dog. Reward the dog when it ignores gunfire. Do not reward the dog when it shies away from or aggresses toward gunfire. As the dog accepts gunfire at varying distances, introduce advanced training. Progress to larger caliber weapons and, if possible, expose the dog gradually to mortar, artillery, and grenade simulators. When the dog is proficient in gunfire, introduce the command "COVER." This simply means that on the command of execution, the handler gives his dog "DOWN" and assumes the prone position. Great care and caution must be used to prevent a potential safety mishap during this phase of gunfire training.

Training supervisors must understand during this phase of training the handler will be placed in a difficult position to protect themselves (from a dog attack) while in the prone position next to their dog. As in all initial stages of dog training, training supervisors and handlers need to remember there might be a period where the dog may not produce the desired behavior at first; therefore, practice and patience is a must for the dog to master this task.

4. Scouting. Scouting is the most effective procedure to locate intruder(s) hidden in a large area. The following factors affect the MWD's ability to scout.

a. Wind. Wind is the most important and variable factor in scouting. It carries the scent either to or away from the dog; therefore, the handler must remain aware of direction and velocity at all times and must fully understand how this affects the dog's ability to successfully perform this task. Handlers must be capable of accurately identifying wind direction in all types of terrain and/or situations without outside sources. For example, at night or other limited visibility situations it may not be feasible to drop hair or a blade of grass to check wind direction. The best way to check the wind direction is to remove head gear and turn slowly until the breeze creates a cool feeling on the upper forehead. As mentioned earlier, not only is it important to know the proper wind direction it is equally important to know how wind speed will affect your scout. An ideal wind speed is difficult to pin point, but normally slight, steady and consistent wind conditions will produce the best scouting results for dog teams.

b. Terrain. The next important consideration is terrain. Besides manmade structures, there are trees, bushes, large rocks, high grass, and many other natural variations. Odor cannot pass through obstacles, so it must go over, under, or around them. Handlers must understand how these obstacles come into play when performing scouts with their MWDs.

c. Additional Factors. Additionally, the MWD trainer and agitator must remain aware of the wind direction and their route when walking within the area that the dog will search. Agitators should always approach the area from the upwind flank to ensure the dog does not cross the path and track the agitator. Trainers should also take the same precaution when training multiple dog teams. The agitator should be moved between scouting problems so dogs cannot track each other. Other factors that affect scouting abilities and conditions are

24 FEB 2020

rain, snow, sleet, temperature, and humidity. These factors affect the odor concentration or scent cone in numerous ways.

5. Scouting Problems. Set your scouting problems to match the proficiency of the dog team. For example, when quartering a field, an advanced dog may be able to consistently locate the decoy from 40 yards. This should be considered when bounding forward when quartering the terrain to locate decoy. Use chase agitation to build drive in weak dogs. Once teams are proficient in initial scouting problems, advance to realistic problems including vast areas of the installation. Vary the terrain to include wooded, as well as developed areas. Use your imagination and set real world scenarios, including the use of other flight members for back-up, and response forces. There should be an even balance of bite training incorporated into scouts.

6. Maintaining Proficiency. When a team arrives at a proficient level to scout and clear an area, there are many ways to keep the dog team proficient.

a. Field Problems. Designed to evaluate use of scouting principles. The area should have a variety of terrain features, and the handler must know the area boundaries.

b. Patrolling Exercises

(1) Usually consist of point-to-point posts; however, a specific or a designated area might need securing.

(2) Training Procedure. The trainer places several intruders along the line of patrol 75 to 100 yards apart along the route the dog team takes. Position the agitators off the line of patrol, far enough to challenge the dog's detection capabilities, but, not defeat it. Set up all three types of responses to include sight, scent, and sound. At the conclusion of the exercise, the handler indicates the number of agitators found.

7. Security Problems. Set up realistic problems with the goal of extending the period of time the dog team remains alert on regular sentry posts. Supervisory personnel can use these problems to best evaluate the dog's training and the abilities of the handler to control the dog.

a. Alternate teams between different types of posts as training progresses. Initially, each team is used on-post for



about 30 minutes before the agitator hides on the post or tries to penetrate the post.

b. At this advanced stage of training, do not use the command "FIND'EM" to get the dog to respond unless it is absolutely necessary. Once the dog responds, replicate normal apprehension and escort procedures.

c. After a few nights of this training, the teams tour of duty is extended to either four or six hours, as determined by posts and training time. The extended training time is necessary to condition the dog to remain alert and watchful over a normal tour of duty. Vary the number of penetrations for each team in time and number. This variation keeps the dog alert for penetrations.

d. Penetrations serve two purposes:

- To check the security of an area, and
- To maintain a patrol dog team's proficiency. The penetrator tries to enter the post undetected and, if successful, hides along the handler's route where he/she must allow the dog to detect the intruder.

e. A patrol dog team gains no training benefit from an exercise in which the agitator/intruder penetrates a post with the intent to elude detection. The penetrator must not use the same route or time of approach. If he/she does, the handler and dog begin to anticipate arrival. The penetrator must use cover and concealment when penetrating a post, to avoid revealing the position before reaching the post perimeter.

f. Training emphasis is placed on developing the detection capabilities of the dog. Sometimes it is necessary for the penetrator to make his or her presence on the post more obvious.

g. During the early stage of training, the penetrator must not use diversionary tactics because these tactics may confuse the inexperienced dog team.

h. An effective penetrator must have the dog team's proficiency training in mind. He/she must employ sound judgment and adapt methods to the situation matched to the proficiency level of the team. These practices apply during training as well as under field conditions.

8. Building Search. Use a building search to locate an intruder hiding in a structure. Factors that influence an MWD's ability to scout also affect its ability to locate an intruder inside a building. A variety of air currents are common inside buildings just as they are outside buildings.

a. Wind direction outside buildings correlates with the direction of air currents inside by filtering through any openings such as windows, doors, vents, and cracks in floors.

b. Type and size of buildings and wind direction will affect the dog's ability to detect an intruder.

c. Air conditioning units, fans, and heater blowers affect the speed and direction of airflow. Changing air currents can confuse the dog in its effort to locate the intruder.

d. Temperature inside and outside a building may influence the concentration of odor. Cold temperatures will keep the odor closer to the surface, while warm temperatures will cause the odor to rise.

e. Residual odor from personnel who recently departed the building may serve to distract the dog.

9. Building Search Training. Set your building search problems to match the proficiency of the dog team. Use chase agitation to build drive in weak dogs. Conduct initial training with a six-foot or a thirty-foot leash. Make your problems more difficult as the dog progresses. Once your team is proficient in initial building search, conduct advanced searches in realistic environments. Use your imagination to set problems that challenge the capability of the team. Use other watch members to act as back-up, over watch and response forces. As in all training scenarios the safety of the handler, agitator and dog must be at the forefront of your scenario planning at all times.

a. Initial Building Search Training Procedures. In initial building search training, allow the dog to see, hear, and smell the intruder just inside the building at the entrance door. Gradually move the intruder into a room, allowing the dog to detect by the use of intruder movement (vision and sound); then progress to the dog locating the intruder by odor. When the dog responds to the odor of the intruder, by barking, scratching, etc., ask the dog "WHAT YA GOT?" Verbally reward the dog as it makes the required response and enter the room to allow the dog

24 FEB 2020

to bite the intruder. As the dog responds correctly to the following trials, move the intruder into the next room to teach the dog the intruder location was moved. Gradually lengthen the search, one room at a time until the dog searches the entire building. Then randomly position the intruder throughout the building. Conduct all building searches in a systematic manner, preventing duplication. The handler should always clear an area or room before passing it and maintain an avenue of escape. Dogs are trained to make one of the following final responses upon locating an intruder. Vocal (bark, growl, whine), scratching, biting, or ceasing movement at the intruder location.

b. Intermediate Building Search Training Procedures (On-Leash). Hide an intruder in the building for a designated period of time prior to the search. The trainer/supervisor should adjust the time based on dog's ability, building size and difficulty of search. The handler should cue the dog to start searching for the intruder with the command of "FIND'EM" to begin a systematic search at the appropriate starting point. The handler allows the dog to clear the building observing any indication the dog detected the intruder. Tell the handler the location of the intruder during training to help identify responses. The trainer should accompany the team occasionally to give added advice and assistance as needed. When the handler is sure the dog has detected the intruder, reward the dog with a CRS using verbal and physical praise. You may use a bite reward if it enhances the dog's proficiency. Remember, the dog is also operating on a VIRS at this point. To assure the dog that the intruder is really present, you may find it necessary to reveal the intruders presence by noise or even show a portion of the intruder's body. Eventually the dog develops proficiency on odor cues only. When possible, terminate all building search exercises by having the team escort the intruder from the building.

c. Advanced Building Search Training Procedures (Off-Leash). Cue the dog to start a systematic search similar to the on-leash search. The handler must follow the dog as much as possible to keep it in view. The handler must react instantly when the dog responds. Conceal the intruder in a location not accessible to the dog. The intruder should remain quiet and allow the dog sufficient time to search out the hiding place. A dog that has performed well to this point, will have learned to search systematically and efficiently on its own without the handler close by. A dog should eventually search out the intruder without assistance from the handler. If the dog responds on an

area where the intruder was previously hidden, make certain the area is cleared, then repeat the command "FIND'EM" and continue the search. During actual (not training) searches, a single trial where no reward is given constitutes an extinction trial. This single trial will not degrade the dog's subsequent performance due to the fact the dog is on a VIRS. Once you have trained a dog on this schedule, you have proven behavior is highly resistant to extinction.

d. Actual Building Search Procedures. When conducting an actual building search, the following factors must be considered.

- (1) Potential danger to the handler and MWD.
- (2) Type and size of building (speed of search).
- (3) Time of day or night.
- (4) Evidence of forced entry.
- (5) Known or suspected contents of the building.
- (6) Possibility of innocent persons inside.

(7) After considering the advice of the handler, the on-scene commander will determine whether to search the building on or off-leash. The handler must announce in a clear, loud voice that he/she will release the dog to search the building if no one appears within a specified time. This allows intruders the opportunity to surrender or innocent persons the opportunity to make their presence known. If no one appears, the handler will allow the dog enough time to clear the immediate area before proceeding. The handler will then follow the dog to each unclear room until the building is cleared.

(8) If an intruder is located, recall the dog, challenge, and apprehend the intruder. Another watch/patrol member should accompany dog teams. This individual should follow at a discreet distance to avoid interference with the search. This additional person is needed to provide over watch protection to the handler since the handler must focus his or her attention on the dog and not necessarily the threat associated with the building search itself. If an intruder is found, the security forces person who accompanied the dog handler can perform a quick body search and remove the individual.

24 FEB 2020

(9) Do not enter the building until backup units have secured all avenues of escape. If forced entry is indicated, but search results are negative, consider using the dog's scouting or tracking capabilities. If the situation allows, the building custodian should be called to the scene prior to security forces members entering the facility. By having the custodian on scene, they should be able to provide more in-depth information of the facility and possibly identify what is out of place and what is not associated with the building.

10. Decoy Techniques. The decoy (or Helper) plays a vital role in developing the drives of an MWD. Trainers, handlers, and decoys should know the dog's temperament and gear the training to build a solid balance of prey and defense drive. Decoys must always remember their ultimate goal is assisting in the building of the dog's proficiency levels and aside from the safety of themselves and other personnel involved in dog training this should always be at the forefront of training.

a. Temperament. Temperament is the combination of all of a dog's mental and emotional attributes, disposition, and personality. By understanding and evaluating temperament, we can predict trainability in any working dog. Experienced trainers can modify behavior and cover temperament flaws; however, you cannot completely change basic temperament.

b. Instinct. Instinct is a dog's innate response to certain stimuli, independent of any thought process such as chewing, vocalizing, digging, leg lifting and scratching. Instincts most often have their roots in survival or reproduction.

c. Drive. MWD drives is discussed later in tab G2, paragraph 4.a(18).

d. Imprinting. The imprinting process makes an initial impression on a dog that will evoke a lasting or permanent reaction or behavior, usually associated with the untrained dog's initial learned reaction to a given stimulus or set of stimuli.

e. Compulsion. Compulsion is using the application of pain or negative stimuli to extinct a behavior, evoke a response, or otherwise modify a dog's behavior. Use of compulsion in patrol dog training can adversely affect drives and ultimately result in undesired behaviors. One example includes a dog that avoids the handler after a bite. Through excessive use of compulsion, the dog has associated the handler with negative stimuli

24 FEB 2020

(correction), and therefore avoids the handler to delay or avoid the correction. Another example of the inauspicious effect of compulsion is a dog that slows his pursuit as he reaches the decoy and doesn't fully commit to the bite. In this case the dog has associated the decoy or the distance with a previous correction in "stand-off" training.

f. Anthropomorphism. Anthropomorphism is to place human characteristics, motives, or emotions on a dog. Example: "My dog is bored with training and will not work." This type of statement contradicts quality training and exemplifies a misunderstanding of the animal.

g. Shaping. Shaping is rewarding nearly correct responses as a dog is learning a task. As the training continues, reward only those responses that are more like the desired final response. Shaping is highly effective in teaching a task without compulsion.

h. Rewards. Rewards are born out of drives and used to evoke the desired behavior. The anticipation for the reward drives the dog more than the reward itself. The drive for the reward can help trainers predict trainability. Use the bite, slip, and carry as a reward to satisfy prey, defense, and fight drives.

i. Learning Curves. Learning Curves is an analytical theory that depicts fluctuations in an animal's ability to learn a task. The curve will depict the starting point, the peak, the drop off, and the flat areas of a dog's learning abilities. As the trainer begins to teach a task, the dog is eager to satisfy the drive, the starting point of the learning curve. As training progresses, the trainer can apply the learning curve using care to terminate the training session at the peak. Training beyond the peak will push the dog into the flat area. The dog is unable to properly learn a task in the flat area and will invariably respond incorrectly. At this point the trainer is counteracting the positive learning that occurred in the beginning of the trial. The ideal training session will flow through the incline of the curve and stop at or near the peak. By consistently following this routine, the trainer ensures that all training is conducted in a positive manner, ingraining an enduring desire for the dog to successfully complete the tasks. Failure to understand and track learning curves is common among dog trainers and will lead them to assume that the animal is unable or unwilling to comprehend and complete a task.

24 FEB 2020

j. Presenting for the High Bite (Decoy). When the dog is in pursuit, the decoy waves the sleeve at shoulder height, ensuring that the dog targets high. As the dog leaps for the bite, the decoy pulls the sleeve in at chest level and forces the dog to fully commit to the bite. This method instills confidence and fight drive in the dog. This will transfer to the actual (suspect) bite. Failure to build this confidence will result in the dog failing to commit to the actual bite because he has anticipated the presentation of the sleeve.

k. Working the High Bite. The decoy works the sleeve at chest level while standing in an upright position. This forces the dog to give a harder and fuller bite. While working the dog, the decoy gives as the dog attempts to bite deeper, and pulls as the dog lets up. This conditions the dog to maintain a hard and full bite. A dog that is trained with the high bite is less likely to nip a suspects clothing and more likely to fully bite and hold the individual.

l. Pull Down in the Bite. If the bite is weak or mouthy, the handler and decoy work together to build the dog's bite. With the dog on a six-foot leash and leather collar, the handler applies backward and downward pressure on the leash while the dog is on the sleeve. The decoy works the dog in the high bite. The handler and decoy must apply pressure when the bite is weak causing the dog to fight harder for the full mouth bite. Then simultaneously release the pressure and allow the dog to readjust the bite. Do this two or three times to build the dogs bite. As the dog takes a fuller and stronger bite, reward the behavior by slipping the sleeve and allowing the dog to carry or parade with it in a circle.

m. Confidence Bite. Used as a stress relief for the animal. Because the presence of a decoy causes stress in the dog, you can use this technique to release the stress before a training session. Simply allow the dog to attack the decoy and take the sleeve. Let the dog carry the sleeve in a wide circle at a medium gait. Do not let the dog thrash or manipulate the sleeve, and do not use verbal or physical corrections with the dog. Once the dog has calmed down, the decoy can entice him with a second sleeve.

n. Reward Bite Method. The reward bite develops a willingness to release the sleeve and return to the handler by using positive motivation. This method has helped solve several long standing problems in military working dog training, including failure to release a bite, attacking during a stand-

off, hesitation in the attack, handler avoidance, and handler aggression. The reward bite is divided into three progressive steps, all of which are conducted with the dog on a 30-foot leash.

(1) Double Ball Method (Step 1). This technique teaches a willingness to release while the animal is in a low state of drive. It also produces willingness for the dog to return to the trainer. The trainer uses two identical prey reward items such as balls, kongs, tug toys, jute rolls, or play rags. The trainer throws one of the items and the dog is sent to retrieve it. Once the dog returns to the trainer, he is enticed with the second item. This creates a conflict within the animal between the desired item and that which he already possesses. The conflict leads to a willingness to release the possessed item, which has no movement, and rewarded with the desired item. The trainer must add enough movement to the second item to build the desire to release. Do not reach for the item that the dog possesses, let it drop to the ground, and immediately reward the dog with the second item. To end this training session provoke the release and escape the dog away from the area. Do not progress to the next step until the dog willingly releases the prey item.

(2) Double Decoy Method (Step 2). This technique follows the same principle as the double ball method, releasing the dead object (no movement) for the one with life (movement). Adding the presence of the decoy in this step evokes aggression in the form of fight drive and makes it more difficult for the animal. Step 2 is comprised of three phases.

(a) Phase I. The dog is sent for a bite and the first decoy slips the sleeve. The trainer should then walk the dog in a circle. Do not allow the dog to drag, thrash, or manipulate the sleeve, these behaviors degrade the training. To prevent this, increase the gait causing the dog to lift the sleeve high for the carry. The second decoy evokes the dog by adding life to the other sleeve. The dog's focus will shift from the dead sleeve to the one with life. The trainer should not correct the dog or interfere. Let the natural drive dictate the dog's behavior! He will release and transfer to the sleeve with life. The second decoy rewards the dog with the slip of the sleeve. End your session by evoking a release and escape the dog away from the area. Once the dog shows consistency on this phase, progress to PHASE II.



24 FEB 2020

(b) Phase II. Begin as in PHASE I by sending the dog for a bite on the first decoy while the second decoy is out of the dogs view. The first decoy will not slip the sleeve, after the bite he must freeze and offer no fight or life. The second decoy is introduced and moves close to the dog. Once in position he provides life in the second sleeve, this stimulates the dog's prey drive. The dog will release the first sleeve and take the one with life. There is a period of conflict at this point which will vary from dog to dog. Allow the dog time to make the transition! The handler should not interfere. The key is to let the dog accomplish the tasks through positive reinforcement. Verbal or physical corrections will void this training process and detract from the dogs learning ability. When the dog transfers, the second decoy slips the sleeve providing the reward. Let the dog carry the sleeve in a circle as in PHASE I.

(c) Phase III. Once the dog consistently releases the sleeve in PHASE II, increase the distance between the two decoys, and add the verbal cue "OUT". Give the cue in a moderate tone of voice and time it with the dog's natural release. *At this point the trainer should know the dog well enough to predict the release.* Use successive approximation to add distance between the two decoys, allowing the dog to run back and forth for each bite. Locate the handler between the decoys and encourage the dog as he makes the transfer. The goal in PHASE III is to have your handler, dog and decoy positioned as in a standard controlled aggression training session. The second decoy is located behind the dog team out of sight. As the first decoy freezes, the handler commands "OUT" the dog should release cleanly and return to the handler with enthusiasm because he anticipates the reward bite. As the dog is returning to the handler, he is redirected to the second decoy. From this point begin to extinct the second decoy by commanding the dog to "HEEL" follow the proper heel with a reward bite on the same decoy. As in all aspects of dog training, vary the routine to prevent anticipation on the dog's part.

(3) Obedience Bite. This training principle is an extension of the reward bite; it consists of the same techniques, but is employed differently. The dog is cued to conduct an obedience task and rewarded for the correct behavior with a bite, slip, and carry. Use of this training method will create positive focus on the handler and higher drive in obedience. The end result provides a more reliable and confident animal. This method also helps to eliminate hesitation problems.

24 FEB 2020

(4) Continuation Training. Employ the reward bite method intermittently throughout training. Use it to build the dog in all aspects of patrol training, including building search and scouting. When you use the reward bite in these scenarios, the decoy should work the dog to get a full hard bite and then release the sleeve. The training supervisor predetermines the level of "fight" the decoy uses, always striving to build the dog's confidence and reliability.

o. False Run (Decoy). The objective of this exercise is to condition the dog to remain in position and not bite unless commanded to. Conduct initial training on-leash. When the handler commands the MWD to stay, begin to suspiciously advance towards the dog. Use successive approximation and move toward the dog from the starting position. The dog's actions will dictate how many trials it will take to completely train the dog. If the dog attempts to bite, or fails to remain in position, the handler must immediately correct the dog. To prevent the dog from becoming deficient in aggression and attack, the agitator and handler should decide when to give the dog a bite. To maintain aggressiveness, you may allow the dog to bite on a random basis during this type of training. To fully condition the dog, the decoy should mimic provocative behavior encountered in real-world situations.

p. Controlled Aggression. Used to teach the dog to pursue, bite, and hold on command. The team starts in the HEEL/SIT position off-leash. Wearing the arm protector, move around suspiciously about 40 to 50 feet in front of the team. The handler will order the agitator to halt and place their hands over their head. The agitator ignores this order, turns, and attempts to run away. The handler commands the dog "GET'EM." When the handler calls the dog "OUT," the decoy ceases all resistance and agitation.

q. Stand-Off. This training enables the handler to gain complete control over the dog after commanded to pursue. The starting position is the same as with the attack and apprehension. Approach the dog making provocative gestures. When you get within a few feet, turn and run away. After you're about 30 feet from the team, the handler will command "GET'EM." When you hear this command, cease all movement. The dog will be called "OUT." This training may become confusing to the dog; therefore, to keep it at an acceptable level of aggressiveness, allow it to bite at irregular intervals. NOTE: You may vary

24 FEB 2020

time and distance in all aspects of stand-off training depending on the dog's proficiency level.

r. Double Decoy Attack. This exercise requires an additional decoy. The purpose of this exercise is to teach the dog to ignore one of the decoys while pursuing, biting, and holding the other. The dog starts off-leash in the HEEL/SIT position. Position the decoys approximately 30 feet from the dog team. The handler challenges by ordering them to halt. One decoy obeys the command while the other ignores it and runs away. The handler immediately commands "GET'EM." The dog ignores the decoy that halts and pursues, bites and holds the second decoy. During the early stages of this training, attract the dog's attention by making provoking gestures and noises.

s. Scouting. The primary mission of the MWD is to detect and warn the handler of the presence of an intruder. The team is placed in a semi-cleared area facing into the wind. The terrain features in front of the team should allow the decoy to run and crouch behind bushes and trees. Before the decoy starts to run, the handler tells the dog to "WATCH'EM," the decoy will run from one point to another, acting suspicious, and hide at a pre-designated position of cover. The decoy will leave cover and run when the team is within 15 feet. This exercise is concluded with a short chase and bite.

t. Building Search

(1) On-Leash Building Search. Introduce the building search on-leash as an agitation exercise ends in such a way that it will seem a natural extension of agitation training. For example, as an agitation exercise ends, the agitator runs away from the dog and hides behind the doorway to an adjacent building. The team will pursue to the doorway. The agitator continues to provoke the dog to illicit a desire to pursue. The procedures remain the same until the dog is ready to advance to the next step, which is to enter a building and actually seek out an intruder while concealed on floor level. To assure the dog of the agitator's presence, you may need to provide a faint noise or an obvious movement for the dog. The noise and/or actions should cause the dog to bark or produce a response. The decoy may have to agitate or act afraid of the dog to get a favorable response. Conclude this exercise with the team escorting the agitator out of the building.

24 FEB 2020

(2) Off-Leash Building Search. During off-leash building search, perform exercises in the same manner as on-leash. Conceal the agitator in a location inaccessible to the dog, either floor level or an elevated position. The agitator must remain quiet and motionless allowing enough time for the dog to detect and respond. The agitator(s) may need to make noise or partially reveal themselves to ensure success. The ultimate goal is for the dog to detect and respond to the agitator while separated from the handler.

TAB G8

Specialized Search Dog Training

See reference (ao) for information on  
SSD training guidance.

**TAB G9**

**Combat Tracker Dog Training**

**See reference (ao) for information on  
CTD training guidance.**

**APPENDIX H**

Military Working Dog (MWD) Status Reporting Guide

**Table of Contents**

<u>IDENTIFICATION</u>	<u>TITLE</u>	<u>PAGE</u>
<b>PARAGRAPHS</b>		
1	Purpose.....	H-1
2	Introduction.....	H-1
3	MWD Status Data Entry.....	H-1
<b>FIGURES</b>		
H-1	MWD Lifecycle.....	H-3
H-2	MWD Status & Loss Comment Data Entry in WDMS Kennel Master / MWD MGMT Tab.....	H-3
<b>TABLES</b>		
H-1	MWD Status/Loss Comment Options.....	H-4

1. Purpose. To provide Marine Corps MWD sections with a guide that will support the accurate and consistent reporting of MWD operational status data in WDMS utilizing an entry process that is streamlined and understandable.

2. Introduction. WDMS has the capability for the reporting of the MWD operational status during the asset lifecycle as illustrated in figure H-1. The key factor for status determination is the "MWD Status" which becomes the basis for "MWD Availability" that in turn is used to compute "MWD Team Readiness". Accurate and consistent assignment of the MWD Status code is important to ensuring that WDMS is an effective management tool in reporting and highlighting MWD capability readiness and deficiency to all command levels. At the end of the MWD lifecycle, the MWD status entry and loss comment selection work together to provide an accurate record of the nature of the asset loss.

It is imperative that each kennel master closely supervise the timely and accurate recording of the MWD Status in accordance with the guidance provided in this document.

3. MWD Status Data Entry. As illustrated in figure H-2, the **MWD Status** and **Loss Comment** fields are recorded in the Kennel Master/MWD Mgmt Tab. During the majority of the MWD lifecycle, the MWD Status will be "Operational", "Deployed" or "On Mission"

and require only minimal daily attention to status updates. On occasional situations, the MWD status will change for TAD or temporary medical situations. At the end of the lifecycle, status changes will be required to identify that the disposition process has been initiated. Table H-1 provides instructions relating to the options available for recording MWD Status.

a. End the MWD team assignment before an MWD can be transferred within WDMS.

b. Within seven calendar days of the MWD departure, record the actual shipping date as the "LOSS DATE" in WDMS MWD management. The loss date is important since it is used to compute MWD gain/loss reporting.

c. Update the MWD records in WDMS up to the reported command lost date.

d. Report the MWD status in WDMS at the time the MWD section is notified to ship the MWD. This will be the last MWD status entries required by the shipping MWD section unless the MWD is returned at a later date.

**IMPORTANT**

When the MWD has to return to the temporary custody of the 341 TRS, JBSA-Lackland for medical or training purposes, the 341 TRS will manage the MWD Status entry [**see notes (1) and (2) in table H-1**] as required for internal tracking. During the relocation, the MWD Status shown in the USMC WDMS module will be as recorded by the 341 TRS and cannot be changed by the USMC assigned command. The 341 TRS will assign the MWD Status as "Operational" on transfer back to the assigned command.



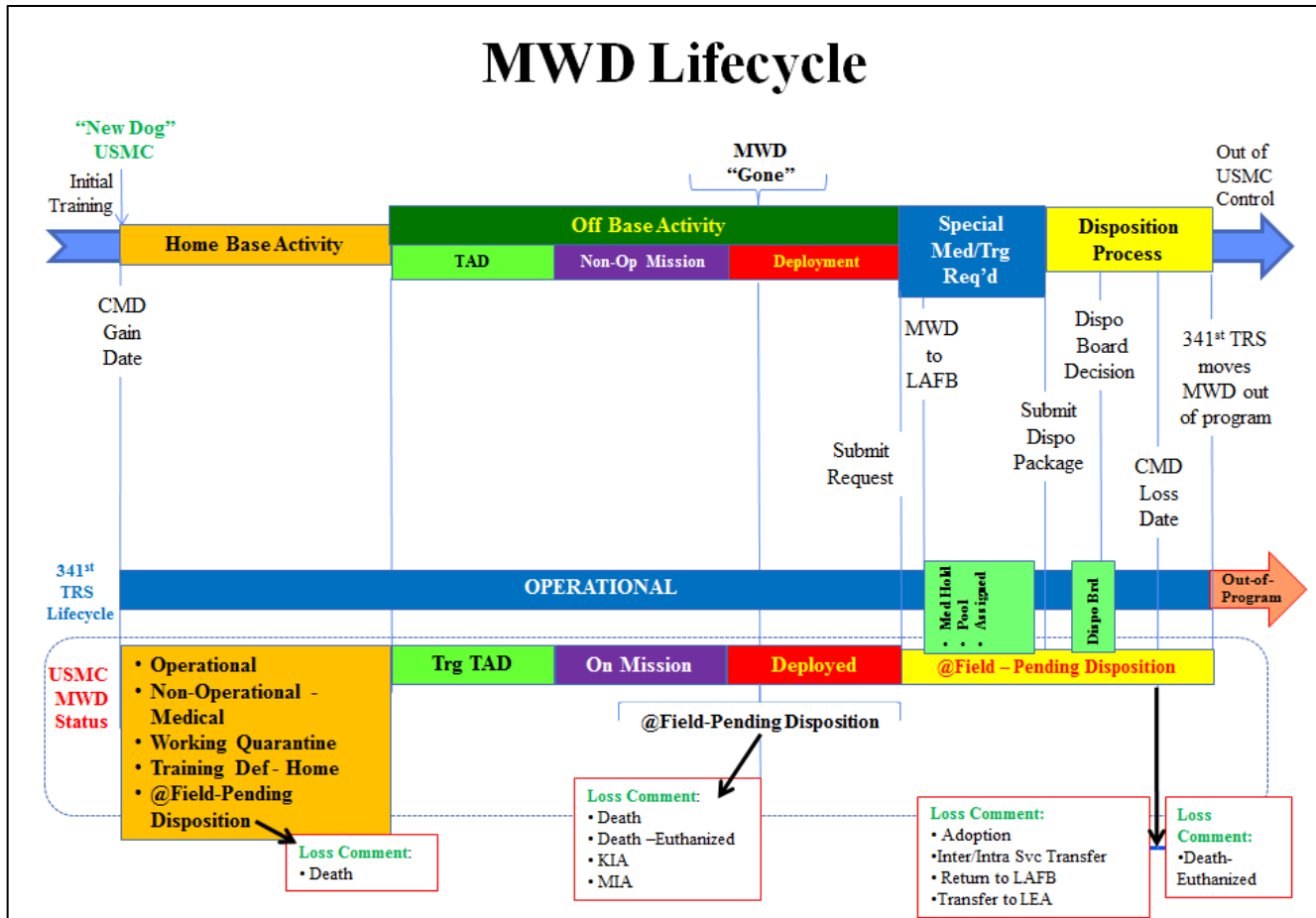

Figure H-1.--MWD Lifecycle

Edit values in the desired fields, then click the Update button to save changes.

CMD Gain Date:  (mm/dd/yyyy)

CMD Loss Date:  (mm/dd/yyyy)

**Current MWD Availability:**  
Available

MWD Status:

MWD Status:

MWD Status:

MWD Status:

MWD Status:

Med Cat:

Med Cat:

Med Cat:

Loss Reason:

Loss Reason:

Loss Reason:

Loss Reason:

Loss Reason:

Loss Reason:

Loss Reason:

Loss Reason:

Loss Reason:

Loss Remarks:

MWD Training Log					
Course Name	Focus	Completion Date	Comment	Delete	Add

Figure H-2.--MWD Status & Loss Comment Data Entry in WDMS Kennel Master / MWD MGMT Tab

Table H-1.--MWD Status/Loss Comment Options		
MWD STATUS CATEGORY	MWD LOSS COMMENT [Enter at the Loss Date]	Explanation/Effective Reporting Period
@Field-Pending Disposition (3)(4)(5)(6)	Adoption	From the date the disposition package is submitted to the date the MWD is removed from the MWD section in WDMS by the 341 TRS.
	Death	Starts the date the MWD died of natural causes at any duty station.
	Death-Euthanized	Starts the date the MWD is euthanized by VCO based on local decision or one from a disposition board due to the serious nature of illness or injuries.
	Inter-Service Re-assignment	[Transfer of MWD to another DoD service branch] From the date the transfer letter is received until the MWD is removed from the MWD section in WDMS by the MWD PM.
	Intra-Service Re-assignment	[Transfer of MWD to another USMC location] From the date the transfer letter is received until the MWD is removed from the MWD section in WDMS by the MWD PM.
	KIA	Starts the date the MWD is <u>Killed In Action</u> by hostile activity.
	MIA	Starts the date the MWD is declared <u>Missing In Action</u> by hostile activity. MWD disappears while on assignment for unknown reasons [runaway, stolen, etc.].
	Return LAFB	From the date the transfer letter is received to the date the MWD is removed from the MWD section in WDMS by the 341 TRS.
	Transfer to LEA	[Transfer of MWD to a non-DoD Law Enforcement Agency (LEA)] From the date the disposition package is submitted to the date the MWD is removed from the MWD section in WDMS by the 341 TRS.
Deployed	N/A	From the date the MWD departed the home section and is in route to/from, or participating in, an operating force support commitment to the date of return to the home station.

24 FEB 2020

<b>Table H-1.--MWD Status/Loss Comment Options</b>		
<b>MWD STATUS CATEGORY</b>	<b>MWD LOSS COMMENT [Enter at the Loss Date]</b>	<b>Explanation/Effective Reporting Period</b>
Non-Operational - Medical (1)(5)	N/A	The dates the MWD is at the home station [except 341 TRS], but a medical condition exists that impedes daily duty performance [except under conditions of "Working Quarantine"] and is under diagnosis, observation or treatment. MWD is expected to recover and return to full duty. This status can be associated with any Medical Category.
On Mission	N/A	From the date the MWD departs with the handler from the home section and is in route to/from, or participating in, the same activities described in table 8-4 for a handler with Person Status Category "On Mission".
Operational	N/A	Dates when the MWD is at the home section and is physically capable of being teamed with a handler and of completing the qualification process.
Training Def-Home	N/A	<u>Training Deficiency-Home</u> : Starts the date that the MWD is suspended at the home station from being assigned to operational duties due to an identified unsatisfactory performance tendency [e.g., declining detection capability, uncontrolled aggression]. Remedial skill training is required until performance reaches an acceptable level.  <b>NOTE: Val/Cert qualifications must be revoked at the time this status is assigned [see Chapter 5 for details on revoking a team qualification].</b>
Trg TAD (2)	N/A	<u>Training Temporary Assigned Duty (TAD)</u> : From the date the MWD departs the home section and is in route to/from, or participating in, an approved MWD skills development course until the date of return to the home station. When a handler accompanies the MWD, the handler will have the TAD status category during this period of assignment.

24 FEB 2020

Table H-1.--MWD Status/Loss Comment Options		
MWD STATUS CATEGORY	MWD LOSS COMMENT [Enter at the Loss Date]	Explanation/Effective Reporting Period
Working Quarantine	N/A	<p>During the period that an MWD is declared to be restricted to the kennel compound / base for training purposes only due to one of the following reasons:</p> <ol style="list-style-type: none"> <li>1. At home section and restricted due to an unprovoked bite incident. The VCO will monitor the MWD for rabies.</li> <li>2. New arrival at foreign installation. Period of restriction varies with host country regulations and the supporting veterinarian's direction.</li> </ol>
<p><b>NOTES:</b></p> <p>(1) Once an MWD is received at the 341 TRS for medical treatment, the MWD status code will be changed in WDMS by the 341 to "MEDICAL HOLD". The MWD will be shown as TAD in the WDMS dashboards. <b>Each day the MWD is away, the handler should record the reason for Untrained/Unutilized as "MWD Sick".</b></p> <p>(2) Once an MWD is received at the 341 TRS for an MWD/handler training course, the MWD status code will be changed in WDMS by the 341 TRS to "POOL" then "ASSIGNED" after a specific instructor/class is assigned. The MWD will be recorded as "TAD" in the WDMS dashboards. <b>Each day the MWD is away, the trainer should record the reason for Untrained/Unutilized as "MWD TAD/TDY".</b></p> <p>(3) @Field-Pending Disposition is selected <b>only after</b> the disposition package [when applicable) has been submitted to MWD PM per Chapter 7 and the submission date is recorded in the WDMS dispo log [KM/MWD Mgmt Tab].</p> <p>(4) Once the Disposition Board makes a determination of disposition package, the 341 TRS will assign the MWD status to "EXCESS" in a majority of cases.</p> <p>(5) MWD with this status is restricted from being assigned to a detection event.</p> <p>(6) In the event of death in field, the MWD section enters the MWD status as "@Field-Pending Disposition" and initiates the notification specified in paragraph 8204.1. Once the required documentation has been relayed to the MWD PM, the 341 TRS will remove the MWD from the assigned base in WDMS along with changing the MWD status to "Terminal".</p>		

**APPENDIX I**

Military Working Dog (MWD) Team Equipment Guide

**Table of Contents**

<u>IDENTIFICATION</u>	<u>TITLE</u>	<u>PAGE</u>
<b>PARAGRAPHS</b>		
1	Purpose.....	I-1
2	Introduction.....	I-1
3	Scope.....	I-2
4	Issue Equipment Types.....	I-2
5	Quantity Requirements.....	I-2
6	MWD Protective Equipment.....	I-2
7	Replacement.....	I-3
8	Equipment Physical Inventory..	I-3
<b>TABLES</b>		
I-1	Issue Equipment Types.....	I-2
I-2	MWD Team Equipment Chart.....	I-3

**NOTE:**

**This Appendix reflects information available at the time of this publication. Updates to detailed descriptions and NSNs will be provided when available in future manual changes.**

1. Purpose. This appendix provides a guide for unique MWD Team equipment that is normally issued to a handler during different operational commitments.

2. Introduction. The MWD team is expected to operate in different operational environments to provide a unit commander a force multiplier with the MWD capability. To accomplish this task, the handler must be provided the unique type of MWD equipment identified in this guide. This equipment will augment the standard personal equipment/weapons issue for the operating situation and other unit garrison and deployment equipment of the type discussed in Chapter 9. The handler will normally be expected to take personal custody of the issue items and be responsible to move them to/from and during the operational period. The amount of equipment may vary depending on the duration of the operational period and availability of replacement items from other sources. Consequently, the kennel master will adjust the actual issue levels taking these factors

into consideration. Lack of available necessary functional and serviceable MWD equipment may prevent the MWD team from achieving full effectiveness.

3. Scope. The equipment in this guide will cover a range of situations from garrison training to remote operations for both the Supporting Establishment (SE) and the Law Enforcement Battalion (LE Bn) MWD sections.

4. Issue Equipment Types. Normally, items of the types identified in table I-1 are issued to the handler upon being teamed with an MWD and maintained during the duration of the handler's assignment with the MWD section. The table identifies those most commonly used issue items by type along with National Stock Number (NSN) references for procurement purposes.

<b>Table I-1.--Issue Equipment Types</b>	
<b>Type</b>	<b>Description</b>
Issue - Basic	Common use item issued to each MWD handler.
Issue - Size	Item is stocked in various sizes and issued to each MWD team according to the physical characteristics of the MWD or [in limited cases] the type task to be accomplished.
Issue - [MWD ID]	Item to be issued to each handler based on operational requirement unique to the MWD type (CTD, Patrol, SSD).
Supplement	Item that is required to complete the specific team assignment or perform MWD skill specific training. Normally maintain at the unit level and issued to the handler on a temporary basis to complete the task.

5. Quantity Requirements. Table I-2 provides recommendations to assist the KM in determining at least the minimal initial stocking level for team equipment. The percentage (%) following the size in the use column represents the item stocking level unless usage data dictates an adjusted figure. The figure in the issue quantity column represents the quantity of issue for basic, size and MWD specific equipment. For supplemental equipment, the issue quantity represents the number of items that should be maintained to support an MWD section.

6. MWD Protective Equipment. The MWD PM has provided MWD protective equipment (ear, eye and paw) to each MWD section as defined under the category ISSUE-SIZE in table I-2. Most MWDs will be distracted by wearing this type of equipment; therefore,

24 FEB 2020

it is important that kennel masters and trainers conduct regular training is conducted with this equipment to ensure the MWD is comfortable in its use during situations where protection is applicable.

7. Replacement. The nature of issue equipment is that it is subject to frequent wear and tear. It is the responsibility of the handler to ensure this equipment is maintained in a clean and functional condition.

8. Equipment Physical Inventory. MWD sections should conduct a physical inventory of all MWD support equipment at least semi-annually.















Table I-2.--MWD Team Equipment Chart [Sorted by Item]					
Item	Type	Picture	NSN	Use/ Specification	Issue Qty
Apron Bite K9	Supplement			Must be made of heavy leather, with adjustable neck strap and long ties at waist.	1 per 6 Patrol
Apron, Grooming	Supplement			Lightweight, Grooming Apron, treated to protect from water, hair, and chemical stains. Two front pockets, zippers on pocket bottoms. Neck strap with five snaps and long ties at waist.	1 per 4 MWD

Table I-2.--MWD Team Equipment Chart [Sorted by Item]					
Item	Type	Picture	NSN	Use/ Specification	Issue Qty
Bag (Gear)	Issue- Basic			Must be a back pack type bag capable of carrying gear needed for MWD with a minimum of 1709 cubic inches of cargo space and 100 ounce hydration system built in, durable abrasion resistant material with multiple storage compartments. Be able to integrate into existing MOLLE system. Color shall be service related camouflage or appropriate color.	1 per MWD
Ball, Gripper	Issue- Patrol/S SD			<ul style="list-style-type: none"> <li>• Rapport building</li> <li>• Line drills</li> <li>• Physical conditioning</li> <li>• Patrol work (beginning stages)</li> <li>• SSD directional</li> </ul>	1 per Patrol & SSD
Ball, Solid Rubber, 3"	Issue- Basic			<ul style="list-style-type: none"> <li>• Basic reward</li> <li>• Hard Rubber</li> </ul>	1 per MWD
Baton, Bamboo	Suppleme nt			Canine training device constructed of bamboo sections that will make noise of clatter when struck. Size 24 inches to 30 inches long.	1 per 10 Patrol
Bowl Collapsibl e (Water) (Food)	Issue- Basic			Durable outer shell with a seamless waterproof liner, leak proof and spill-resistant. 5 inches in diameter, 4 inches high, 5 cup volume, collapsible to 5" Lx5 inches Wx2" high, must have 3/4" side release buckle.	2 per MWD



Table I-2.--MWD Team Equipment Chart [Sorted by Item]					
Item	Type	Picture	NSN	Use/ Specification	Issue Qty
Brush, Slicker, Safari, Universal	Issue- Basic			Curved head; stainless steel bristles.	1 per MWD
Clippers, Extra Wide Blade, Dog Hair	Issue- Basic			<ul style="list-style-type: none"> <li>• Issue only if dog grooming requires.</li> <li>• Stock 50% of MWD</li> <li>• 16' power cord with storage case.</li> </ul>	As Req'd
Collar, Chain, Choke, Round Steel,	Issue- Size			4.0mm round with common lengths: (18")(20")(22")(24")(26")	1 per MWD
Collar, Leather, 1" Wide	Issue- Size			Common lengths: (20")(22")(24") Made of leather, must have heavy duty brass ring and buckle.	1 per MWD
Collar, Leather, Handle, Heavy	Issue- Patrol			2"x24" With handle [one size fits all]	1 per Patrol
Collar, Nylon, Double Ply	Issue- Size			Common lengths: (20")(22") (24") Made of nylon, must have heavy duty brass ring and buckle.	1 per MWD
Collar, Pinch	Issue- Patrol/S SD			Made of stainless steel, and designed to spread pressure evenly around the MWD's neck. End links must be rounded. Common Lengths: (20")(23")(27")	1 per Patrol & SSD
Comb, Animal, stainless steel (shed blade)	Issue- Basic			Stainless steel dual sided (fine/course) shedding blade, plastic handle. 7- 1/4" Med/Coarse	1 per MWD
Comb, Animal, wooden handle	Issue- Basic			Chrome nickel plated brass body, wooden handle .031 inches between teeth, and 38 teeth.	1 per 2 MWD

24 FEB 2020

Table I-2.--MWD Team Equipment Chart [Sorted by Item]					
Item	Type	Picture	NSN	Use/ Specification	Issue Qty
Comb, Tool, De- Shedding	Issue- Basic			<ul style="list-style-type: none"> <li>• Stock 50% of MWD.</li> <li>• De-shedding edge 2 3/4", stainless steel edge.</li> </ul>	As Req'd
Cuff, Champion Jute	Suppleme nt		8415 - 011- 22- 0686	Bite sleeve cuff made of jute, natural material. [W/84/90/91]	1 per 4 MWD
Cuff, DLX	Suppleme nt		8415 - 016- 16- 2866 , 8415 - 016- 16- 3376	Bite sleeve made of synthetic materiel.	1 per 4 MWD
Cuff, Intermedia te Sleeve	Suppleme nt		8415 - 011- 22- 0678	Tan Outside, Jute Outside, Length 29", w/Leather Straps	1 per 4 MWD
Cuff, Small	Suppleme nt		8415 - 006- 16- 0164	8415-006-16-0164	1 per 10 Patrol

24 FEB 2020





Table I-2.--MWD Team Equipment Chart [Sorted by Item]					
Item	Type	Picture	NSN	Use/ Specification	Issue Qty
E-Collar	Supplement			Transmitter and Electronic Collar: Fully recharged in two hours, enclosed internal antenna on receiver with IR/white light option, remote operated from transmitter. Hand held transmitter shall be water resistant and must be capable of controlling multiple (6) waterproof receivers with multiple continuous and multiple momentary stimulation and audible tone, up to a distance of one mile, with case. Includes dummy collar which is same size and weight as the actual receiver.	1 per SSD
Gun, Training, Beretta, 9mm, Solid Rubber, Red	Supplement			<ul style="list-style-type: none"> <li>•Made of rust-proof molded urethane</li> <li>•Shaped, sized and detailed to duplicate a Beretta 9mm/.40</li> </ul>	1 per 10 Patrol
Gun, Training, M4, Solid Rubber, Red	Supplement			<ul style="list-style-type: none"> <li>•Rust-proof molded urethane</li> <li>•Reinforced construction</li> <li>•Shaped, sized, and detailed to duplicate the M4 Carbine</li> </ul>	1 per 10 Patrol
Harness, Radio	Issue- SSD			Special use with radios required for off-leash directional control	1 per SSD

Table I-2.--MWD Team Equipment Chart [Sorted by Item]					
Item	Type	Picture	NSN	Use/ Specification	Issue Qty
Harness, K9, Repel	Issue- Size			Only issues when required for team mission. Common Sizes: Large (10%) Medium (10%)	As Req'd
Harness, Patrol Nylon,	Issue- CTD/ Patrol			Common Sizes: Medium (70%), Small (30%)	1 per CTD & Patrol
Harness, Tracking, Leather	Issue- CTD			Does not restrict MWD yet allows handler to control at a distance. Sizing is based on dog's girth: Medium: 23 - 30 inches Large: 25 - 39 inches	1 per CTD
Helmet, Bite Suit	Suppleme nt			Must completely protect head, neck and face, and be fully padded.	1 per 10 Patrol
Jacket, Trial	Suppleme nt			For Use With Hidden Sleeve	1 per 2 Patrol
Kong	Issue- Size			<ul style="list-style-type: none"> <li>• Reward item</li> <li>• Hollow rubber</li> <li>• Common sizes: Large (20%) Typical chewer</li> <li>• X-Large (80%) Power chewer</li> </ul>	1 per MWD
Lead (Retractable)	Issue- Basic			Stock 25% of MWD 26 foot retractable lead, with soft grip handle, positive locking system and instant stop brake. Made of nylon. Shall contain a belt clip.	As Req'd
Lead, Alternative, 30 Foot	Issue- Basic			Stock 10% of MWD 30' lead made of nylon. Must contain 1 inch brass snap on one end.	As Req'd

24 FEB 2020







Table I-2.--MWD Team Equipment Chart [Sorted by Item]					
Item	Type	Picture	NSN	Use/ Specification	Issue Qty
Lead, Leather, Braided, Custom, 60 Inches	Issue- Basic		3770 -01- 110- 9901	Dog Leash - Leather Agitation Lead; One Piece Construction; Braided And Tied; 5' For Agitation; 0.75" W; Knotted At Snap End And Braided At Handle End; Either Solid Brass, Ludell (Italian) Snap ¾". Eye Or North And Judd No. 5080, Heavy Duty Cadmium Snap; Tubular Steel Rivet With Steel Washer Backing; Leather, 11 To 15 Oz Retanned Chrome/Oil,Backs Only; Leather Meets Current Mil Spec For Strength	1 per MWD
Lead, Nylon, Agitator	Issue- Patrol			2"x15', lead made of double ply nylon. Must contain a handle on one end and 1" brass snap on the other.	1 per Patrol
Lead, Nylon, Agitator, 6'	Issue- Basic			6' lead made of double ply nylon. Must contain a handle on one end and 1" brass snap on the other.	1 per MWD
Lead, Nylon, Agitator, Rubber, 15'	Issue- Basic			General use for all MWDs	1 per MWD
Leash - Nylon, 6'	Issue- Basic			General use for all MWDs	1 per MWD
Leash - Nylon, 33 Ft	Issue- CTD/SSD		3770 -00- 171- 1256	<ul style="list-style-type: none"> <li>• Tracking</li> <li>• Advanced obedience work</li> <li>• Transitioning to off-leash training</li> </ul>	1 per CTD & SSD











Table I-2.--MWD Team Equipment Chart [Sorted by Item]					
Item	Type	Picture	NSN	Use/ Specification	Issue Qty
Leash - Leather, 6'	Issue- Basic		3770 -01- 322- 7647	General use for all MWDs	1 per MWD
Leash, Gripper, 5/8"x15'	Issue- Basic			Stock 50% of MWD	By preferen ce
Leash, Gripper, 5/8"x30'	Issue- Basic			Stock 50% of MWD	By preferen ce
Leash, Nylon, 1"x33', 360	Issue- Basic			Stock 50% of MWD <b>360 inches (30 foot) Lead made of nylon webbing with 1 inch brass snap on one end.</b>	By preferen ce
Muzzle - Fabric	Issue- Size			<ul style="list-style-type: none"> <li>• Transporting MWDs through commercial airports</li> <li>• USSS missions</li> <li>• <b>Do not use on distressed MWD</b></li> <li>• #6 (Malinois) (50%) 60-80 lbs</li> <li>• #7 (Shepherd) (50%) 80-100 lb</li> <li>• <b>CAUTION:</b> Prevents MWD from panting &amp; drinking, which can lead to MWD overheating.</li> </ul>	1 per MWD
Muzzle - Wire	Issue- Size			<ul style="list-style-type: none"> <li>• General purpose</li> <li>• Allows the MWD to breathe freely.</li> <li>• MWD can drink water while wearing</li> <li>• Common Sizes: Large (50%) Medium (50%)</li> </ul>	1 per MWD

Table I-2.--MWD Team Equipment Chart [Sorted by Item]					
Item	Type	Picture	NSN	Use/ Specification	Issue Qty
Muzzle - Leather, Heavy	Issue- Patrol			<ul style="list-style-type: none"> <li>• Agitation / attack training</li> <li>• Common Sizes: Malinois (50%) Shepherd (50%)</li> </ul>	1 per Patrol
Muzzle - Leather, Light	Issue- Size		3770 -00- 105- 2717	<ul style="list-style-type: none"> <li>• Standard Military Style.</li> <li>• Best and most comfortable.</li> <li>• It allows for free breathing and causes the least alarm and apprehension.</li> </ul>	1 per MWD
Muzzle - Plastic	Issue- Size			<ul style="list-style-type: none"> <li>• Issued when required</li> <li>• General use Malinois (30%) Shepherd (30%)</li> </ul>	As Req'd
Pad, Belly	Issue- Basic			Issue when required. Simple mat that MWD can lay on while in the kennel or deployed.	1 per 2 MWD
Pants, Scratch, Nylon	Suppleme nt			Patrol LEVEL 4: Protects legs from MWD scratches during bite work.	Large (1 per 10 Patrol)  X-Large (1 per 6 Patrol)

24 FEB 2020











Table I-2.--MWD Team Equipment Chart [Sorted by Item]					
Item	Type	Picture	NSN	Use/ Specification	Issue Qty
Protection - Body	Issue- Size			<ul style="list-style-type: none"> <li>• Work in - <ul style="list-style-type: none"> <li>❖ High risk areas for explosive devices</li> <li>❖ Areas with high overgrowth that may result in sticks or thorn injury</li> <li>❖ Close quarter entries</li> </ul> </li> <li>• Recommended only for short durations. MWD must be watched closely for overheating.</li> <li>• Stock for 20% of MWDs</li> </ul>	As Req'd
Protection -Ear	Issue- Size			<ul style="list-style-type: none"> <li>• Work in high decibel sound areas</li> <li>• High risk areas for sudden high impact explosions.</li> <li>• General Rule -- if handler needs ear protection then so does the MWD.</li> <li>• Common Sizes: Small (25%) Medium (50%) Large (25%)</li> </ul>	1 per MWD
Protection -Eye (Doggles)	Issue- Basic			<ul style="list-style-type: none"> <li>• Work in windy conditions with sand/dirt in the air.</li> <li>• Work in areas with high overgrowth that may result in sticks or thorn injury.</li> </ul>	1 per MWD



Table I-2.--MWD Team Equipment Chart [Sorted by Item]					
Item	Type	Picture	NSN	Use/ Specification	Issue Qty
Protection , K9, Paw	Issue- Basic			<ul style="list-style-type: none"> <li>• Work in extreme temperature environments</li> <li>• Work around high risk of sharp objects</li> <li>• Work in industrial areas with potential hazardous liquids on the ground</li> <li>• Work in areas with high overgrowth that may result in sticks or thorn injury.</li> </ul>	1 per MWD
Protector, hand	Suppleme nt			Durable material that completely incases the hand and wrist to prevent hand injuries from accidental bites. Left and right.	1 per 10 Patrol
Ring, Repelling	Issue- Basic			Break-a-way device for attaching leash to handler vest. Carabiner w/Locking System, Break Away	1 per MWD
Sleeve, Gauntlet, Leather	Suppleme nt			Patrol LEVEL 4: Designed to be worn under bite sleeves and suits for added protection during bite work. Must be made of leather, no less than ¼ inch.	1 per 5 Patrol
Sleeve, Gauntlet, Neoprene gauntlet	Suppleme nt		8415 -01- 122- 0679	Designed to be worn under bite sleeves and suits for added protection during bite work. Must be made of neoprene, no less than ¼ inches.	1 per 10 Patrol
Sleeve, Hard	Suppleme nt			Patrol LEVEL 3: Must have no metal or outside plastic parts, bite bar, padded handle inside.	1 per 10 Patrol



24 FEB 2020

Table I-2.--MWD Team Equipment Chart [Sorted by Item]					
Item	Type	Picture	NSN	Use/ Specification	Issue Qty
Sleeve, Hidden	Supplement			Patrol LEVEL 4: The purpose of the hidden sleeve is to ensure that the MWD will bite with no equipment visible. This sleeve is not as hard as a bite bar or an intermediate sleeve. Your decoy will experience some pressure bites through the hidden sleeve. When utilizing this sleeve, you should wear loose clothing so that the sleeve is indeed hidden. This sleeve is made of synthetic material.	1 per 10 Patrol
Sleeve, Hidden, Leather, Left, Large	Supplement			Patrol LEVEL 4: The purpose of the hidden sleeve is to ensure that the MWD will bite with no equipment visible. This sleeve is not as hard as a bite bar or an intermediate sleeve. Your decoy will experience some pressure bites through the hidden sleeve. When utilizing this sleeve, you should wear loose clothing so that the sleeve is indeed hidden.	1 per 20 Patrol

24 FEB 2020

Table I-2.--MWD Team Equipment Chart [Sorted by Item]					
Item	Type	Picture	NSN	Use/ Specification	Issue Qty
Sleeve, Hidden, Leather, Right, Large	Suppleme nt			Patrol LEVEL 4: The purpose of the hidden sleeve is to ensure that the MWD will bite with no equipment visible. This sleeve is not as hard as a bite bar or an intermediate sleeve. Your decoy will experience some pressure bites through the hidden sleeve. When utilizing this sleeve, you should wear loose clothing so that the sleeve is indeed hidden.	1 per 20 Patrol
Sleeve, Intermedia te, European, Left Arm	Suppleme nt			Must have no metal or outside plastic parts, and have a collapsible bite bar and padded handle inside.	1 per 10 Patrol
Sleeve, Intermedia te, European, Right Arm	Suppleme nt			Must have no metal or outside plastic parts, and have a collapsible bite bar and padded handle inside.	1 per 10 Patrol
Sleeve, Jute cover	Suppleme nt			Must be made of jute with a handle incorporated into design and interior padding. Bite sleeve covers cuffs are a must for any hard sleeve.	1 per 10 Patrol
Sleeve, Leg	Suppleme nt			Must have handle outside bite area, full length closure on back, and contain two removable bite bars / tugs.	1 per 10 Patrol

24 FEB 2020

Table I-2.--MWD Team Equipment Chart [Sorted by Item]					
Item	Type	Picture	NSN	Use/ Specification	Issue Qty
Sleeve, Puppy	Supplement			Patrol LEVEL 1: The puppy sleeve is utilized primarily for young MWDs. When conducting bite work with this sleeve, you want the MWD to give you a solid, full mouth bite consistently. Once the MWD is proficient with this sleeve, you may move on to a harder sleeve. Not T/E item - local buy only since this type of training is not normally performed at an MWD kennel. Possible use to start aggression training on DDD or EDD and for remedial bite training.	1 per 20 Patrol
Sleeve, Soft, Ambidextrous	Supplement		8415 - 011- 22- 0678	Patrol LEVEL 2: This sleeve is utilized on a more daily basis for everyday training. It is similar to a hard sleeve with the exception of not having a bite bar inside the sleeve. This will be utilized on MWDs that possess a medium to hard bite. This is also utilized to reinforce the amount of pressure in the bite along with the full mouth.	1 per 6 Patrol

24 FEB 2020





Table I-2.--MWD Team Equipment Chart [Sorted by Item]					
Item	Type	Picture	NSN	Use/ Specification	Issue Qty
Sleeve, Trial, Left	Supplement			Patrol LEVEL 3: The bite bar is utilized for your consistently hard biters. It should not be used on a new MWD until they have successfully progressed through the first two sleeves. There is also a difference in materials from the jute toy to hard burlap.	1 per 10 Patrol
Sleeve, Trial, Right Cuff, Champion	Supplement			Patrol LEVEL 3: The bite bar is utilized for your consistently hard biters. It should not be used on a new MWD until they have successfully progressed through the first two sleeves. There is also a difference in materials from the jute toy to hard burlap.	1 per 10 Patrol
Stake (Tie out)	Issue- Basic			18' -24' long, steel, domed shaped top to prevent the dog's chain from being tangled, flat pieces of steel welded to the sides of the stake to prevent stake from turning in ground, a larger top portion capable of withstanding the insertion into the ground by hammer, d-Ring type swivel to attach chain.	1 per MWD

Table I-2.--MWD Team Equipment Chart [Sorted by Item]					
Item	Type	Picture	NSN	Use/ Specification	Issue Qty
Suit, Heavy	Suppleme nt			Patrol LEVEL 5: The bite suit provides the best protection of all the protective equipment, but limits mobility greatly. It should be used to train MWDs that are proficient with all of the other types of bite equipment first. The primary purpose is to train the MWD to bite without regard to extremities, such as arms; thus, influencing both the bite on a man and the bite of chest, back and other areas that are available. Must have hidden closures and gussets, durable and soft material, quick release closures and snaps.	Large (1 per 6 Patrol) X-Large (1 per 6 Patrol)

24 FEB 2020















Table I-2.--MWD Team Equipment Chart [Sorted by Item]					
Item	Type	Picture	NSN	Use/ Specification	Issue Qty
Suit, Tactical, Large	Supplement			Patrol LEVEL 6: The tactical bite suit is a full body suit that is relatively thin and bites can be felt through the material. It allows you to receive a bite almost anywhere on the body that is protected, while providing more mobility than a regular bite suit. The purpose is to teach the MWD that it is okay to bite in different places other than the arms. The decoy should wear full clothing to hide the tactical bite suit as it is supposed to be hidden as well. This suit reinforces biting the man anywhere on the body without knowledge of gear being present. Worn under garment. Must have hidden closures and gussets, durable, soft, and synthetic material, quick release closures, snaps, low profile and extremely maneuverable.	Large (1 per 20 Patrol)  X-Large (1 per 10 Patrol)
Tie Out, Bungee	Issue- Basic			Stock 50% of MWD	By preferen ce
Tie Out, Chain, Heavy, 10'	Issue- Basic			Stock 50% of MWD	By preferen ce

Table I-2.--MWD Team Equipment Chart [Sorted by Item]					
Item	Type	Picture	NSN	Use/ Specification	Issue Qty
Trauma Kit, First Aid, K9 (actual issue config. TBD)	Issue-Basic			As recommended by the U.S. Army Veterinary Corps.	1 per MWD
Trimmer, Nail, K9, Heavy Duty	Issue-Basic			May be included in the K9 First Aid Kit	1 per MWD
Tug, Wedge, Soft Bite, 3 Handle	Supplement			<ul style="list-style-type: none"> <li>Patrol</li> <li>Fixing bite work</li> </ul>	1 per 4 Patrol
Tug, Bite Wurst	Issue-Patrol			Stock 25% of Patrol	By preference
Tug, Jute	Issue-Patrol		3770 - 016- 16- 1867	<ul style="list-style-type: none"> <li>2" x 12"</li> <li>Stock 25% of Patrol</li> </ul>	By preference
Tug, Bite Suit	Issue-Patrol			2"x8" Stock 25% of Patrol	By preference
Tug, Synthetic	Issue-Patrol			2"x16" and made of synthetic material with one handle. Stock 25% of Patrol	By preference
Whip Drop W/Popper	Supplement			Leather covered canine training whip, 24 inches long with a 28 inches leather drop.	1 per 2 Patrol
Whip, Leather	Supplement			Has a flexible lexan plastic core covered with chap leather and is approximately 24" long with a 30" drop. Comes with a rope whiplash and a popper and gives a very loud pop.	1 per 4 Patrol



24 FEB 2020

Table I-2.--MWD Team Equipment Chart [Sorted by Item]					
Item	Type	Picture	NSN	Use/ Specification	Issue Qty
Whip, Lexan	Suppleme nt			Made of durable and flexible delrin plastic, approximately 24" long with a 30" nylon drop and a popper on the end.	1 per 4 Patrol
Whistle, Dog	Issue- SSD			Silent whistle, almost inaudible to the human ear, nickel plated brass whistle with adjustable tone has a frequency that will carry a long distance.	1 per SSD

**APPENDIX J**

Military Working Dog (MWD) Demonstration Guide

**Table of Contents**

<u>PARAGRAPH</u>	<u>TITLE</u>	<u>PAGE</u>
1	Purpose.....	J-1
2	Introduction.....	J-1
3	Scope.....	J-2
4	Agenda.....	J-2
5	Demonstration Area.....	J-3
6	Safety Brief.....	J-4
7	Checklist.....	J-5
8	Question/Answer Period.....	J-5
<b>FIGURES</b>		
J-1	Basic Demonstration Events.....	J-1
J-2	Example Demonstration Layout for Open Area	J-3
J-3	Examples of an Audience Behind Fence.....	J-4
J-4	Handlers Conducting Q/A.....	J-5
<b>TABLES</b>		
J-1	Example Demonstration Agenda.....	J-3

1. Purpose. This appendix provides guidelines for the conduct of a safe and effective demonstration as derived from years of experience from the MWD community.

2. Introduction. The MWD team demonstration is an effective method to educate other service members and the public about the Marine Corps Military Working Dog (MWD) Program and specifically about the various types of MWD team capabilities. Due to the general interest and curiosity that people have about dogs, the demonstration has become a frequently requested activity for every Marine Corps MWD section, either at the



Figure J-1.--Basic Demonstration Events

installation or the MEF. Demonstrations, for either on or off installation events, should be scheduled through the base public affairs office (PAO) to resolve conflicts with operational commitments and to take advantage of favorable publicity opportunities. It is recommended that each kennel master regularly review this appendix with section personnel, especially newly assigned handlers, to maintain an awareness of the importance of the event and the potential negative impact cause by lack of compliance with known precautions.

3. Scope. Each demonstration must be tailored in content to meet restraints imposed by the proposed event area, the size and age of the audience, availability of teams and time limits. Demonstrations can be conducted by both military and civilian police MWD personnel. The safety of the audience is always the top priority while conducting any demonstration. An average demonstration will take 35-45 minutes. Total committed time will depend on the number of questions fielded by the audience, but at least 15 minutes should be planned for the question and answer (Q/A) session.

**IMPORTANT**

- ❖ Only qualified handlers are authorized to handle/train or interact with an MWD.
- ❖ Only qualified MWD personnel who receive the adequate OJT instruction are authorized to perform the task of decoying in bite work.

4. Agenda. Table J-1 is an example of a demonstration agenda which primarily encompasses the four basic types of events illustrated in figure J-1.

<b>Table J-1: Example Demonstration Agenda</b>
Introductions
Safety briefing
Background of the MWD Program
Basic Obedience demo
- On-Leash [verbal]
- Off-Leash [verbal/hand]
Explain why obstacle course is important
Obstacle course demo
Explain how dog detects explosive/drug odor
Actual detection exercise [drug/explosive][on-leash] <i>[May include Odor wall]</i>
Special search demo [if area permits] (off-leash)
Explain patrol duties
Demo - five phases of aggression
Muzzle Aggression
Scout demo [if area permits]
Tracking demo [if area permits]
Gunfire demo [if time permits]
Question & Answer

5. Demonstration Area. The ideal area is one that is fenced to keep the audience away from the MWDs; example such as the on-base obstacle course and run area. When working in an open area, see figure J-2 for an example layout for a safe event.

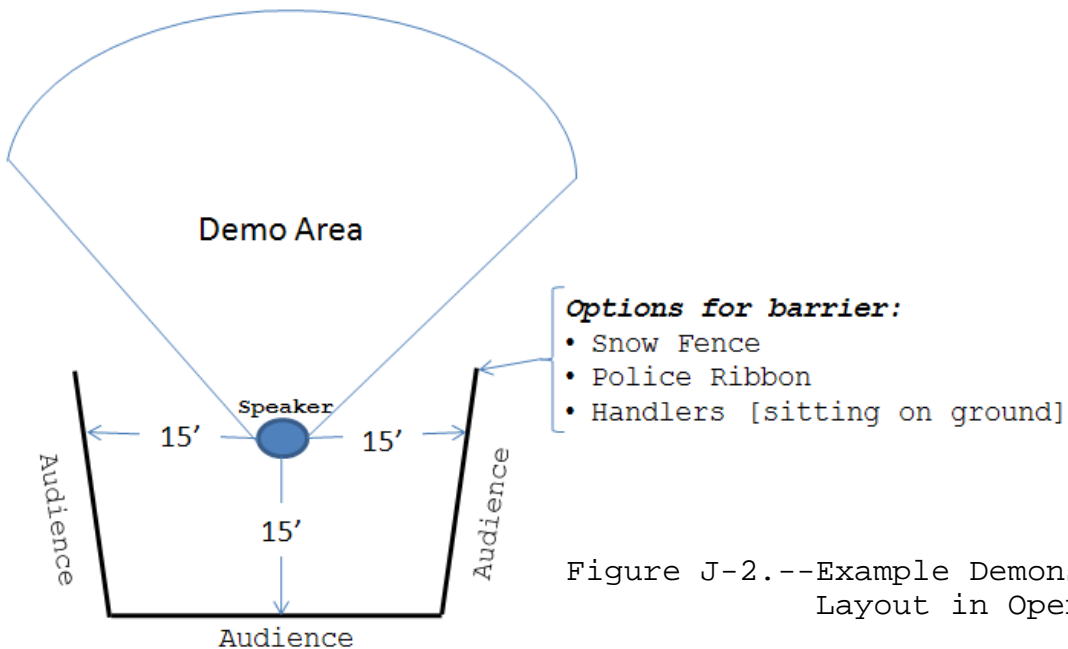

Figure J-2.--Example Demonstration Layout in Open Area

Suggest locating extra handlers as spotters between the demo activity and the audience just in case the MWD is distracted and moves too close to the audience [see figure J-3].

6. Safety Brief. The following are key points that should be included in the safety brief to the audience prior to the start of the demo:

a. Do not extend hands or fingers through the fence barrier when the MWDs are close.

b. No yelling at the MWD for a distraction.

c. Pictures and videos are acceptable, but requested not to post on internet.

d. No open food during the demonstration or throwing food to an MWD.

e. Remain behind the established audience barrier [see figure J-3].

f. Maintain a distance of 15 feet from the MWDs and do not encourage the MWD to come closer.

g. Extra handlers are close to the audience to keep an MWD from being distracted and coming too close to the audience.

h. If an MWD does come too close, do not run; let one of the Marines/GS handlers restrain the MWD.

i. Warn that a decoy could be accidentally bitten during the aggression demo, but that is an occupational hazard and that the handlers are trained to resolve the situation.

j. Remind audience that use of whips is only for making noise and to excite the MWD - never used on the MWD.

k. If blank gunfire is used, the sound level is low, but some audience members may want to cover their ears.



Figure J-3.--Example of an Audience Behind Fence

7. Checklist. Although some of the following checklist items may seem obvious, a quick review as a reminder prior to an event may prevent an undesired public affairs situation.

a. Use of **electronic correctional collars (E-collars)** is **not recommended** for the general public demonstrations, but may be justified for an audience that has a professional need-to-know about the specific use of this device.

b. Ensure all Marine military/Civilian Police Officers are wearing serviceable uniforms and equipment.

c. Have a first aid kit readily available to use in response of an accidental bite.

d. Identify the nearest medical facility to the demonstration area.

e. Remind all demonstrators to pay particular attention to their language used around the public; especially, if there is an accidental bite or the MWD is distracted.

f. Rotate MWD team on different demonstrations.

g. Do not use the same MWD for gunfire and the aggression events.

h. Integrate methods to involve the audience; example - have a member select a piece of luggage in advance for the detection event.

i. Use of mobile obstacles is effective in off-base events.

8. Question/Answer Period. Allow as many of the handlers as possible to stand in front of the audience to field questions [see figure J-4]. Have a prearranged sequence for the handlers to respond to questions. Brief the handlers in advance so they can readily respond to some of the most commonly asked questions listed below. The most challenging questions may be generated by young children.



Figure J-4.--Handlers in Front of Audience for Q/A

24 FEB 2020

- a. Question: How many dogs are in the kennel?  
Answer: Depending on the audience need to know - the answer is "As many as needed to complete the mission".
- b. Question: How much does a dog cost?  
Answer: All dogs are purchased by the Air Force and the unit cost varies and is not known.
- c. Question: Who is the source for the dogs?  
Answer: All dogs are sourced from the Air Force at the JBASA-Lackland where they obtain dogs through their puppy (breeding) program and purchases from commercial breeders both domestic and overseas.
- d. Question: What dog breeds are used in the MWD Program?  
Answer: Malinois / German Shepherd / Labrador
- e. Question: Who provides the Veterinarian care?  
Answer: U.S. Army Veterinarians provides care for all of DoD MWDs.
- f. Question: What happens to dogs when they get old?  
Answer: Primarily adoption to a former handler.
- g. Question: What are the dog limits of detecting drugs/explosives?  
Answer: Dogs are trained to detect odors at various depths/heights.
- h. Question: Have the dogs in the demo been deployed?  
Answer: *Figure provided as appropriate.*
- i. Question: How many Marine dogs/handlers have been wounded / killed on deployment to Iraq and Afghanistan?  
Answer: Depends on audience need-to-know.

**APPENDIX K**

Kennel Facility Design Guide

**Table of Contents**

<u>IDENTIFICATION</u>	<u>TITLE</u>	<u>PAGE</u>
<b>PARAGRAPH</b>		
1	Purpose.....	K-2
2	Introduction.....	K-2
3	Site Planning.....	K-2
4	Exterior Elements.....	K-3
5	Facility Design Considerations....	K-6
6	Interior Working Areas.....	K-7
7	Kennel Area.....	K-13
8	Renovation Considerations.....	K-18
9	Optional Facility Designs.....	K-19
<b>FIGURES</b>		
K-1	Example Kennel Facility Site Plan.	K-3
K-2	Exterior Fence Warning Sign.....	K-4
K-3	Obstacle Course.....	K-4
K-4	Exercise Area.....	K-5
K-5	Facility Walkway.....	K-5
K-6	Kennel Master Office.....	K-8
K-7	Trainer's Working Area.....	K-8
K-8	Handlers Area.....	K-8
K-9	Exam Room.....	K-9
K-10	Isolation Kennel.....	K-10
K-11	Exam Table.....	K-10
K-12	Tack Room.....	K-11
K-13	Food Storage Room.....	K-11
K-14	Multi-Purpose Room.....	K-12
K-15	Latrine/Shower/Locker.....	K-12
K-16	Waterproof Fixture.....	K-14
K-17	Drain #1.....	K-15
K-18	Drain #2.....	K-15
K-19	Kennel.....	K-16
K-20	Kennel Door Design.....	K-16
K-21	MWD House.....	K-17
K-22	Food Prep Area.....	K-18
K-23	Storage/Mech Rooms.....	K-18
<b>TABS</b>		
K1	Obstacle Course.....	K1-1
K2	Example Kennel Facility Plans.....	K2-1



**NOTE**

The information in this appendix was sourced primarily from the unofficial publication "Design Guide for Military Working Dog Facilities" prepared by the 341 TRS, JBASA-Lackland on 5 Aug 2003. Changes have been made to streamline formatting and to update some terminology. The DoD MWD PM has released a new dynamic software tool that helps in the planning of kennel design. The 2014 release is available in the WDMS library.

1. Purpose. This design guide is intended to provide the basic criteria to evaluate, plan, program and design quality Military Working Dog (MWD) facilities. It endeavors to cover the ideal facility requirements and design considerations to provide a successful, quality, cost effective facility to the end user. This guide is intended for all personnel involved from the development through the execution of the project. This guide provides the design basis for a ten indoor/outdoor kennel run facility that includes a staff of one kennel master, two trainers and ten handlers. Areas should be adjusted (larger/smaller) based on the number of personnel and MWDs.

2. Introduction. MWD facilities have long been under the misconception that they "just" board dogs like the stray animal facilities. In reality facilities not only house the MWDs, but include many other functions as well. For instance, all phases of MWD training for patrol and detection take place on the grounds and include storage requirements for equipment connected to training, mobility, contingencies and VIP protection. Veterinary treatment areas are being collocated with MWD facilities. Documentation for handlers and dogs are staged there. Facilities are used as classrooms for teaching drug and explosive training aid safety, canine first aid and non-handler agitator duties. In addition training areas with obstacle courses are used for MWD demonstrations during base tours. In short MWD facilities are more than "just" kennels.

3. Site Planning. In general, MWD facilities should not be located in urbanized, busy areas of the base. Noise from surrounding areas not only affect MWD rest, but the noise from MWDs create a distraction to people working in the area. If unavoidable, incorporate visual and noise barriers such as berms/screen walls to mitigate the distractions. Avoid sites near runways, taxiways, engine test cells, small arms ranges or other areas where the time weighted overall sound pressure level for any 24 hour period exceeds 75 adjusted decibels. Avoid low lying areas that could lead to infestations of mosquitoes,

ticks, rodents and other external parasites. Do not collocate with or site near stray animal facilities.

Ideally all MWD facilities should be located on the same site to avoid excessive travel time and transportation requirements between areas. Figure K-1 is an example of how an MWD facility site works, how areas relate to each other and what is required for each area. It is not intended to serve as a rigid model for duplication.

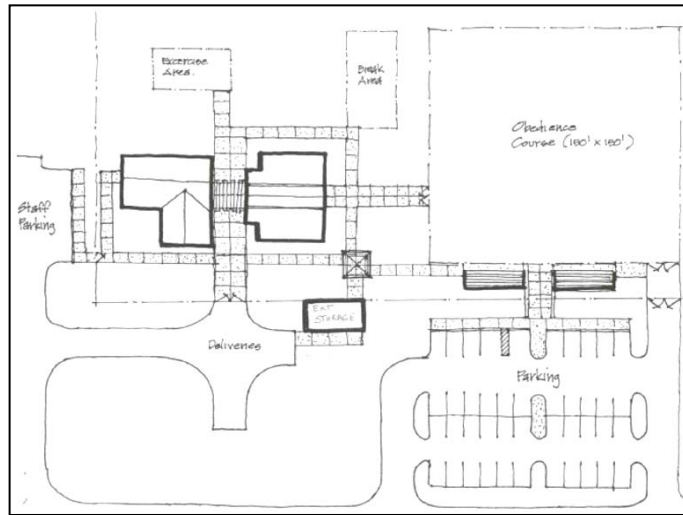

Figure K-1.--Example of Kennel Facility Site Plan

4. Exterior Elements. An MWD complex consists of kennels, support building, obstacle course, exercise area, MWD break area, exterior storage and parking/drives/walks. Often as a result of location, utilities services are limited at the site. Provide as a minimum water (potable, backflow prevention), sanitary sewer, electrical, telephone, network and communication service to the site. Other systems, such as storm, natural gas and steam, should be incorporated in accordance with local procedures.

a. Area Security

(1) Fencing. Fencing plays a major role at MWD sites for obvious reasons. The entire complex should be enclosed with a minimum heavy duty eight-foot high woven/welded wire mesh fence with three strands of straight wire (no barbed) mounted at an inward angle at the top to prevent an MWD from climbing or jumping out.

(2) Gates. A ten-foot (minimum) wide vehicle gate that can be locked (padlock or cypher lock) is to be installed to allow for food deliveries to the facility and other access requirements. An entry gate for personnel that is visible from the KM office is also required. Personnel gate should have a cypher lock and a notification buzzer that sounds in the KM office, obstacle course and the kennel. The buzzer in the

kennel should have the capability to be turned on when personnel are in the area and turned off to allow MWD rest when personnel are absent. All gates should be self-closing/latching. Other perimeter fence types that meet the installation's policy may be used as long as it meets the requirements as a secondary measure to keep MWDs from leaving the compound.



(3) Lighting. Security lighting for the area should be in accordance with local policy.

(4) Signs. Warning signs should be posted on the perimeter fence per regulation [see paragraph 9108 in this Order]. See example in figure K-2.

Figure K-2.--  
Exterior Fence  
Warning Sign

b. Obstacle Course. The training/obstacle course (see figure K-3) plays an important role in maintaining the MWD agility and stamina, as well as, reinforcing obedience and confidence training.



Obstacles are described in Tab K1.

The course should be grassed and free of objects (e.g., trees, large rocks, holes, burrs) that may be harmful to MWDs and handlers. The site should be graded for drainage, but minimally sloped to provide a level field for training. The area should be enclosed with an eight-foot woven/welded wire mesh fence with top guard. Gates should be self-closing/latching and a minimum five feet wide to allow for lawn maintenance equipment.

Figure K-3.-  
Obstacle Course  
(150 ft x 150 ft)

The area should be well lighted with shadows eliminated. Poles should be located on the exterior of the fence. Switching should be manual. Weatherproof outlets should be provided at each light to provide power at the site. Speaker units connected to the chosen PA system should also be provided. Water should be provided to the site with a minimum number of hose bibbs installed to provide water for MWDs and lawn watering. An irrigation system for long term lawn maintenance is desirable.

c. Exercise Area. The exercise area (see figure K-4) is a space where the MWD can be released without the handler being present. The exercise area should not be a shared area with the obstacle course, as it would conflict with training objectives. The exercise area should be visually separated from the obstacle course to prevent MWD distraction during training. The requirement (site work, fencing, etc.) for the area is the same as the obstacle course with the exception of the obstacles.



Figure K-4.--  
Exercise Area  
(20 ft x 40 ft)

d. MWD Break Area. An MWD break area should be located near the kennels. A break area allows the handler to release the MWD immediately after exiting the kennels or before entering the kennels. The area should be enclosed with an eight-foot woven/welded wire fence. Gates should be self-closing/latching and a minimum five feet wide to allow for lawn maintenance equipment. Unlike other grassed areas, a sandy area for cleaning ease is encouraged to be included. A hose bibb is required for maintaining the area.

e. Exterior Storage. An enclosed 400 square feet exterior storage building is required to store, for example lawn maintenance equipment, portable kennels used for transportation, and obstacles. Interior/exterior lighting, power and a hose bibb should be included with the storage building.

f. Drives. Pave access drives to accommodate parking, exterior storage, food deliveries, and transportation of MWDs.

g. Parking. Staff parking should be a paved parking lot to support all anticipated section personnel POVs, organic vehicles, visitors, and handicap [per code] parking space.

h. Walks. Provide paved walks to all areas. Careful consideration of creating one way MWD traffic system is required in the design process. Avoid



Figure K-5.--Facility Walkway

situations which allow MWDs to meet and lead to confrontations. See example in figure K-5.

i. Dumpsters. Locate a trash dumpster outside of the perimeter fence for the complex. Screen dumpster and provide low maintenance landscaping for the complex in accordance with local policy.

## 5. Facility Design Considerations

a. General. The general floor plans shown in Tab K2 are examples of how an MWD facility works, how areas relate to each other and what is required for each space. This guide will provide a starting point in the design process with the identification of requirements and spaces or serve as a rigid model for duplication. The overall complex should reflect the regional and local architectural style and character. This guide should then serve as a supplement to the Installation Design Guide and not as a replacement. It is highly recommended that a plan be established for the entire complex that integrates a common architectural theme throughout. Attention to detail that focuses on architectural compatibility and considers such things as unique facility elements, color, landscaping, signs and site components provide the finishing and unifying touches.

b. Key Item Checklist. The following listing represents a checklist of key considerations that should be evaluated early in the planning process for a permanent kennel facility:

- (1) Individual MWD stalls (dog runs).
- (2) Interior dog run (36 square feet (min) per MWD).
- (3) Exterior dog run (48 square feet (min) per MWD) with a connecting guillotine-type door to the interior dog run.
- (4) Full height access door into run area constructed in such a manner to secure the dog house opening.
- (5) Sealed concrete floor for health reasons and ease of cleaning.
- (6) Kennel floor drains connected to a sewer system.

24 FEB 2020

(7) Kennel walls constructed with woven mesh wire fencing (with enclosed ends to prevent exposed sharp edges).

(8) Each kennel separated with an isolation barrier to prevent MWDs from agitating each other.

(9) Each kennel has a top barrier to prevent MWDs from climbing or jumping out.

(10) A dog house is included in each interior dog run.

(11) A heating capability to maintain the dog house above 35°F during cold weather.

(12) Sufficient open shelter to the kennel so that the MWD is protected from direct sunlight, without reducing the horizontal airflow when the temperature exceeds 85°F.

(13) Consult VCO for recommended kennel temperatures for special theater conditions.

(14) Heating, ventilation, exhaust, general purpose lighting, convenience receptacles in all spaces.

(15) Phone/fax/local area network connections to support each area.

(16) Hot and cold water to all latrines, sinks and showers.

(17) Military Handbook 1008 [see reference listing in paragraph 11] contains all fire protection and life safety feature requirements.

6. Interior Working Areas. An MWD facility consists of the following interior working areas:

a. Administration. See the facility interior layout in Tab K2 for the administration area that provides work space for one kennel master, two trainers and ten handlers. The ultimate goal of this area is to provide professional, well-organized spaces that create a sense of pride in the work place. Since MWD's are likely to visit the area at some point, finishes should be of durable material, require minimal maintenance, and be easily repaired or replaced in case of damage. For example flooring should be hard surface such as vinyl composition tile (VCT) with a cove base.

(1) Kennel Master. The KM office (see figure K-6) serves as the nerve center for the complex. The KM maintains kennels, ensures MWDs are properly cared for, and handlers are knowledgeable of responsibilities. Ideally, the office should be located at the front of the administrative area with exterior windows that view the entry gate to the complex. It should include a lockable closet for storage of supplies. Furnishings should include desk, chair, visitor seating (two), four drawer file cabinet, and bookcase. Equipment should include computer, printer, fax/copier and public address system or central intercom console.

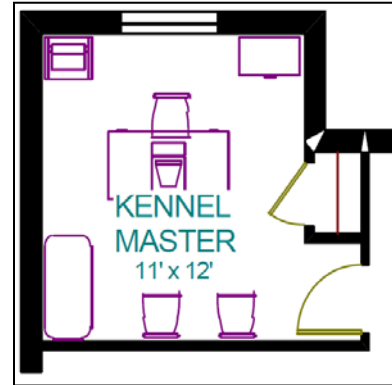

Figure K-6.--  
Kennel Master Office  
(132 sf)

(2) Trainers. Trainers conduct patrol and explosive/narcotic detection training including training on the obstacle course. The trainer office (see figure K-7) will provide workspace for two people. Lockable closets are required to store training aides for each trainer. Furnishings should include desk, chair, four drawer file cabinet for each trainer, and a common bookcase. Equipment should include computer, printer, copier and one 4x8-foot dry erase board.



Figure K-7.--  
Trainers Area  
(240 sf)

(3) Handlers. Handlers work daily with the MWDs. The area (see figure K-8) for the ten handlers is an open area for general office functions. It includes three common workstations for handlers to update records, complete daily reports and space for documentation storage. Furnishings include three workstations, file cabinets (one four drawer vertical per workstation/systems equivalent) and distribution counter. Equipment should include computers and printer.

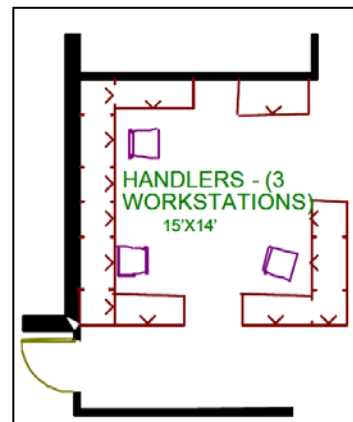

Figure K-8.--  
Handler Area  
(210 sf)

b. Special Use. See the facility interior layout in Tab K2 for the special use area that provides work space for the veterinarian and the unique storage requirements for the facility. The ultimate goal of this area is to provide a professional, well organized space that creates a sense of pride in the work place.

Special use areas are the transition spaces between the administration area and the kennels. While their function is important in the day-to-day operations of the MWD facility, they are not normally occupied on a daily basis. As such, these areas provide a secondary function of serving as a noise buffer between the kennels and the administrative areas.

(1) Veterinary Treatment Room. A veterinary treatment room is used to perform routine physical examinations of MWDs every six months, provide an area for emergency first aid treatment as a result of sickness or accidents, quarantine sick MWDs and serve as a recovery area after dental care.

In order to maintain sanitary conditions, treatment rooms require a higher degree of clean ability/durability than the rest of the support area. Basic finish requirements are seamless floors with an integral base, washable walls, painted gypsum board ceilings, cabinets faced with plastic laminate and solid surface countertops. Interior partitions should provide a STC rating of 50-55. Floor drains should be centered in the room to aid in cleaning and located under the isolation kennel. Wall and base cabinets with drawers should be installed to include stainless steel dual wash basins with hot/cold water. One section of wall cabinets should be lockable, so that prescription medicines for MWDs may be stored in the room. In addition to the normal electrical outlets required by code, a 220 volt outlet is required to support other portable equipment that may be used.

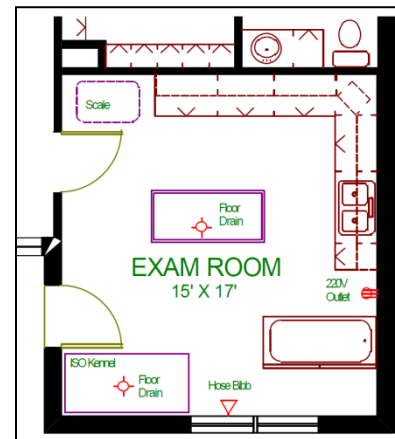

Figure K-9.--  
Exam Room



Equipment for the room would include the following:

(a) MWD Isolation Kennel. Entire structure should be made of uniform, non-glare Type 304 stainless steel (see figure K-10). The frame, cross members and vertical spokes should be welded together at every intersection. Latches and hinges should be made of 12-gauge stainless steel. The floor of the pen should be a raised, removable grate. The floor grate should be heavy gauge stainless steel, plastic-coated section installed 1 ¾-inches off the floor. Dedicated floor drain will be required for this kennel.



Figure K-10.--  
Isolation Kennel

(b) Standard Table Tub. Tub should be designed of Type 304 stainless steel with a minimum depth of 15-inches. The tub should slope to the drain end. The design should include a removable, bathing rack made of plastic coated-stainless steel that fits into the bottom of tub to give the MWD better footing during treatments. Faucets should include a flexible, stainless steel hose that will extend the length of the tub and spray hard to reach areas.

(c) Exam Room Light. Recommend ceiling mounted with arm extension and swivel capacity of 360°.

(d) Walk On Platform Scale. Type 304 stainless steel platform with wall or post mounted LED display. The scale should be able to perform calibration and weigh MWDs to the nearest 0.1 of a pound or kilogram.

(e) Stationary Exam Table. Type 304 stainless steel die-formed from one piece of 20-gauge steel. The top should have raised edges to prevent fluid runoff and permanently attached to a heavy base (see figure K-11). There should be a minimum of 35-inches work height from floor to top of table. Heavy base should have adjustable leveling-screws.



Figure K-11.--Exam Table

(2) Tack Room. The tack room is for storage of MWD equipment, such as body suits and portable kennels for transportation (see figure K-12). The tack room should be located near the entrance to the kennel area and not the main building entrance. Requirements include twelve linear feet of 36-inch deep shelves, a 24-inch hanging space with hooks and six linear feet of 12-inch deep shelves.

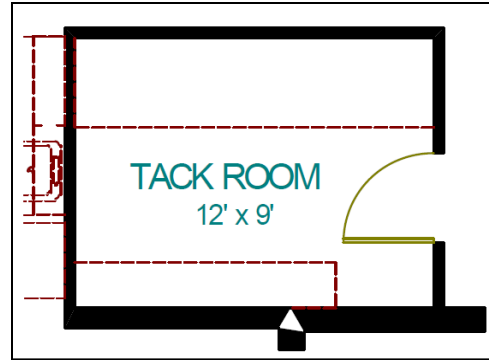

Figure K-12.--Tack Room  
(108 sf)

(3) Food Storage. The food storage room (see figure K-13) is for bulk storage of normally a 30 day supply of food for the dogs. Room should be adjacent to the kennel area with an exterior entry. Entry should be a pair of 36-inch doors to allow for palletized food delivery and storage. Doors require weather stripping and thresholds to aid in insect and rodent control. Temperature and humidity control equivalent to the office area are required in this room to control food spoilage. A minimum separation of two inches from the walls to the stored food is required to allow for air circulation. Shelving should be installed to meet local delivery operations.

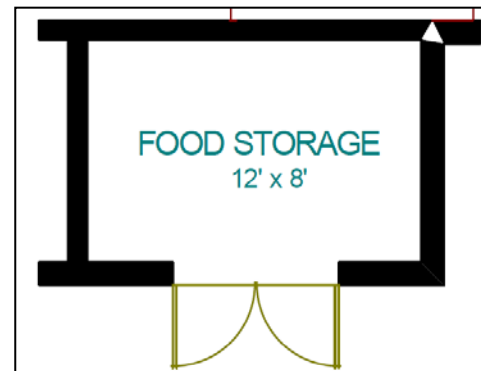

Figure K-13.--  
Food Storage Room  
(96 sf)

c. Support. See the facility interior layout in Tab K2 for the support area that provides space for the common use areas of the building. An area such as, the multipurpose room, latrines, communication and mechanical rooms, form the core of the support areas. The ultimate goal of this area is to provide a professional, well organized space that creates a sense of pride in the work place.

Support areas should be centrally located and easily accessible for building occupants or maintenance personnel in the case of the mechanical room.

(1) Multi-Purpose Room. The multi-purpose room (see figure K-14) serves as a combination conference room, classroom and break room. While food preparation requirements are light, a countertop, base and wall cabinets for storage are required. Lighting should have a variable-level control for use as a conference room/classroom. Furnishings include either a conference table for 15 (or 3 five-person tables), chairs, bulletin board, and one 4x8-foot dry erase screen. Equipment includes video projection system (ceiling mounted, projector screen, sink, microwave oven, and refrigerator.

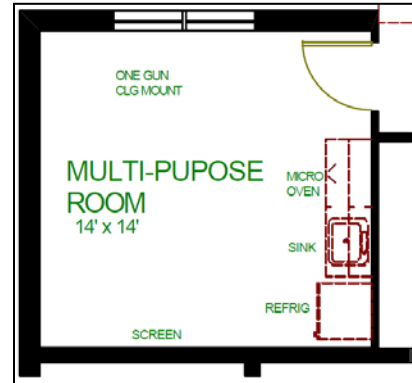

Figure K-14.--  
Multi-Purpose Room  
(196 sf)

(2) Latrine/Shower/Lockers. **Separate Male/Female facilities are recommended.** The latrine/shower/locker (see figure K-15) is subdivided into three rooms. One room is a handicapped accessible latrine with a water closet and lavatory for general use. The locker room includes ten full height metal lockers and bench for MWD handler use. The shower room includes a shower, bench, water closet, and lavatory. Don't neglect to include other accessories, such as, mirrors, soap dispensers, paper towel dispensers, disposal units, grab bars, and hooks.

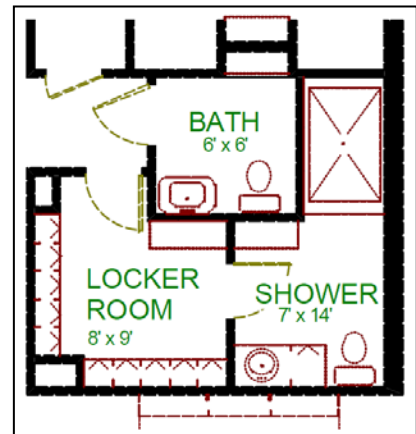

Figure K-15.--  
Latrine/Shower/Locker  
Room  
(206 sf)

(3) Mechanical/Electrical/Communication. In the simplest of terms HVAC is a process to add or remove heat in a facility. It also introduces fresh air to maintain indoor air quality to eliminate the "sick building syndrome". Design HVAC systems to optimize energy use and meet the design criteria for the area you are located. Include the hot water heater in the mechanical room and size to meet the demands of the latrine/lockers/shower, multipurpose room and veterinary treatment room. Allow for location of electrical panels in this area as well. Although a recommended size is shown on the plans, the room should be sized to support the equipment required for the location.

While the number of instruments/computers is not large, the communications closet is vital to the success of the

24 FEB 2020

organization. Provide a minimum of one prewired telephone/LAN outlet per desk/workstation, plus one in each common area and in the kennel food preparation area. Include telephone/LAN outlets for fax machines and printers. Conceal conduit in walls.

**See Chapter 9 [table 9-3] for MWD section administration equipment requirements.**

7. Kennel Area. The kennel area provides the day-to-day living environment for the MWDs by giving each one a place for eating, resting and privacy. Kennel areas should be built to accommodate large breed dogs and should be designed as a modular structure to allow for future expansion of runs. There are three types of kennel areas [see Tab K2 for example floor plans for each type]:

- Indoor Kennels
- Outdoor Kennels
- Combination Indoor/Outdoor Kennels

The combination indoor/outdoor kennel is the preferred standard. There are several factors that must be taken into consideration when selecting the kennel type. Clearly cost is always a consideration in selecting a kennel type, but climate also plays a big role in the selection. In cold weather climates the benefit to cost ratio will drive the selection to an indoor kennel while the opposite is true for hot weather climates. The more temperate the climate the more suited the indoor/outdoor kennel is for use. Each type of kennel includes the same space requirements.

Areas within the kennel include kennel runs with dog houses, food preparation, storage and a mechanical room. It should also be noted, for example, that what applies to the indoor portion of a combination indoor/outdoor kennel also applies to an indoor kennel and vice versa.

The kennel area should be separated from the administrative building by a minimum of 20 feet. This not only provides separation between different functions, it aids in the control of noise from one facility to another. As a result of the constant interaction between the administrative and kennel area, a covered walkway is required to connect the two areas and provide protection from the elements. Care should be taken in the layout of the kennel area in relationship to the administrative building in order to maintain a one way system in the movement of situations where MWDs will meet face-to-face and

prevent confrontations. Consider the installation of mirrors at corners, intersections and blind spots to alert handlers of potential wrong way traffic. All entries/exits from the kennel area are required to be self-closing and self-latching. Doors exiting the kennel runs should open inward to aid in preventing MWD escape.

Proper ventilation is important in the kennel area to prevent the spread of diseases and control odors. It is recommended that the ventilation standard should be ten to fifteen room air changes per hour. In no instance should it be less than eight room air changes per hour.

Kennel temperature should range from 45 degrees Fahrenheit to 85 degrees Fahrenheit with humidity in the range of 40% to 70%. Note that MWDs work more effectively and are more alert when the kennel temperature is close to the temperature of their working environment. Strive to maintain a kennel temperature that is within ten to fifteen degrees of the exterior temperature.

Potable water is required in the kennel area. Hot and cold water lines will be installed at ceiling level down the length of the five-foot wide center corridor connecting to hose reels at each end of the corridor. A high pressure washer is required to assist in sanitizing and cleaning kennel runs.

Since the kennel is basically a wet environment, all receptacles should be provided with ground fault circuit interrupters and all-weather covers. Receptacles mounted at 48 inches above the finish floor are required at each end of the central corridor. Each kennel run should have a waterproof light fixture that is individually switched at the corridor entrances (see figure K-16). Other areas require general purpose lighting in accordance with industry standards.



Figure K-16.--  
Waterproof Fixture

All drain lines in the kennel should be a minimum of six inches [8-inch is preferred] in diameter and should be designed to sustain flow velocities that will maintain self-cleansing action (see figure K-17). Due to the nature of the waste, cleanouts should be numerous and easily accessible. Floor drains should be included in the central corridor to aid cleaning of kennels.

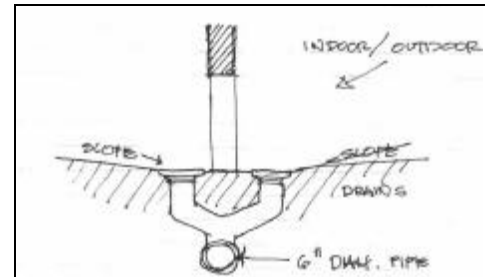

Figure K-17.--Drain #1

a. Indoor/Outdoor Kennel. A combination indoor/outdoor kennel simply implies that there is an interior run and an exterior run linked with each MWD living area. The interior run and the exterior run will be connected by a guillotine-type door. Other door types may be used, but the idea is to permit isolation of the MWD during cleaning operations. Ideally, operation of the door would be from the central corridor and from the outside of the exterior run. At six feet above the finish floor provide translucent wall panels in the wall separating the runs to provide natural light inside the kennel.

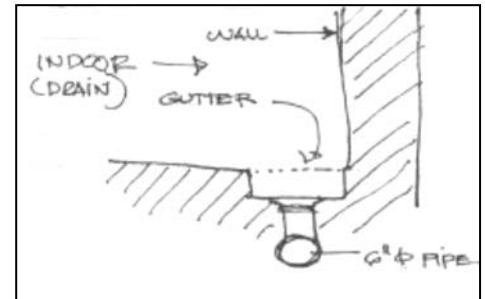

Figure K-18.--Drain #2

The roof should extend entirely over the exterior runs and include gutters/downspouts to prevent excessive water in the runs. Exterior framing should be enclosed with a soffit to prevent birds from roosting. Exterior hose bibbs (freeze protection where required) with both hot and cold water are required at each corner of the building. These are necessary for cleaning of exterior runs.

Floor drains should be located in the corner of each run adjacent to the common wall separating exterior and interior runs. Drains should tie to a common waste line (see figure K-17). Drain covers should be flush with the floor. Kennel floors should slope (at least 1/4-inch per foot) toward the drains to allow for quick water drainage and drying.

b. Indoor or Outdoor Kennel. The plan for the indoor and the outdoor kennel area is the same for either style. The obvious difference is the wall that encloses the kennel area. For an indoor kennel the exterior walls along the runs should have windows beginning at six feet above the finish floor to allow for natural light. Windows should be operable and hinged

at the sill to tilt inward to prevent escape of MWDs. For outdoor kennels the exterior wall is simply an eight-foot woven/welded wire mesh fence. The plan shown allows for additional storage by including eight feet of covered space at the end of the kennel runs. This unfinished space can also be converted to kennel runs in the future for a low initial cost. First cost can be reduced by revising plan to include only the 3-foot walkway all around the kennel runs.

Hose bibbs with hot and cold water are required at each corner of the building. These are required to clean the gutter and drain system for the kennel.

A gutter and drainage system will be provided at the back of the kennel run for either type of kennel for sluicing waste waters from cleaning operations (see figure K-18). Kennel run floors should slope to the gutter and the gutter should slope to the drain. Gutters should be of sufficient to allow for easy cleaning. A minimum of three feet should be allowed between the end of the kennel and the wall or fence.

c. Kennel Run. The size of the kennel run for each dog has been increased to 8x10 feet (see figure K-19). This increase from past guidance resulted from the numerous documented injuries to MWDs particularly in the tail area. Runs should be arranged such that openings are staggered in order to avoid MWDs facing each other across the corridor.

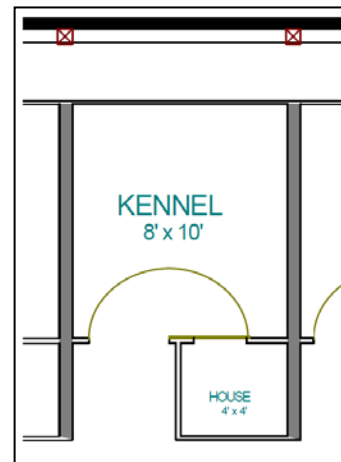

Figure K-19.-- Kennel

Full height partitions are required between runs for all kennel types. The first six feet above the floor should be sealed concrete. For interior runs steel clad acoustical panels should be considered from the top of the concrete partition to the ceiling. Steel clad acoustical ceiling panels should also be considered above the kennels. Heavy gauge woven/welded wire mesh fence is used for exterior runs, but is also an option for interior runs. However, because of the noise generated in the

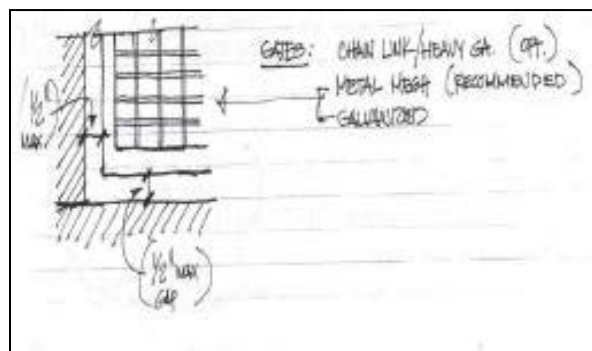

Figure K-20.--Kennel Door

enclosed area of an interior run, it is important that noise reducing materials be introduced to prevent stress to the MWD and hearing loss to personnel. As a minimum, end walls should be full height woven/welded wire mesh fencing. Care should be taken to prevent select a wire assembly design that does not have sharp edges from bolts, hinges, tie wires, etc. to not be on the interior of the runs where the MWD may be cut or harmed. Self-latching entry gates should swing 180 degrees and be able to cover the opening of the MWD house (see figure K-20). This allows the MWD to be penned in the house during cleaning operations of the run. A stainless steel water bucket is required for each run including a holder that will prevent the MWD from overturning the bucket. A better alternative is to provide a "lick" watering system.

Flooring should be concrete and slope toward floor drains and/or gutters to provide rapid run-off of water and drying. Since runs are subject to frequent wash downs to clean and prevent disease, a 3/16-inch epoxy terrazzo finish will provide a long term finish for the flooring. Other alternatives include an epoxy (100% solids) coating to sealing concrete at the low price end.

In general all materials in areas accessible by MWDs should be resistant to damage by scratching, biting and chewing. Materials should be durable and easy to sanitize. Avoid using material such as angle iron that will rust over a period of time and generate sharp edges that will pose a danger to MWDs.

MWD houses are 4x4x4 feet [minimum size] sealed concrete boxes with a metal top (see figure K-21). Fiberglass tops do not hold up over time. Tops should hinge toward the end wall in order to be raised to clean the house or treat an MWD. Once lifted, a holding device should be available to keep the top open. Wall opening dimensions are shown. Slots are required along the sides of the opening to allow a plate (metal, Plexiglas, etc.) to close the opening and prevent MWD entry while the house is being cleaned. The MWD house opening should be a minimum of 8-inch and a maximum of 12-inch above the run floor. The MWD house floor should have positive drainage toward the wall opening.

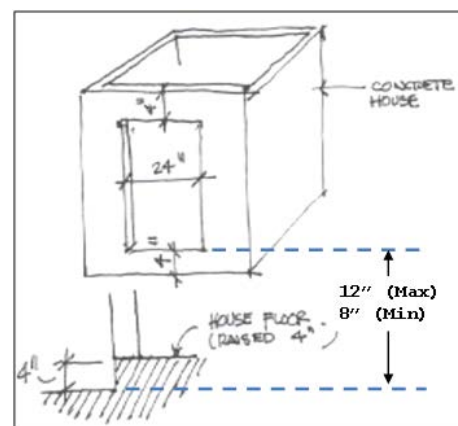

Figure K-21.--MWD House



d. Food Preparation. The food preparation area (see figure K-22) is where feedings are prepared and feeding pans/bowls are stored/cleaned. Food preparation for MWDs dictates a large countertop with a three compartment, deep, stainless steel sink. Upper wall cabinets are required for general storage. Under counter refrigerator, dishwasher and space to store food for daily usage are necessary for operation. A two-foot space at the end of the counter should accommodate storage/drying rack for pans/bowls. Lighting and receptacles should be installed per code and a floor drain installed. A telephone, bulletin board, feeding chart, and large garbage can should also be provided. Optional equipment would include a garbage disposal unit and a stackable washer/dryer.



Figure K-22.--  
Food Prep Area  
(112 sf)

e. Storage/Mechanical. Additional storage for the kennel area is provided (see figure K-23). A commercial quality ice machine is required to aid in cooling down MWDs. Include a floor drain for the area. If a veterinary treatment room is not included, the digital scale should be located in this area. Design mechanical systems to optimize energy use and meet the design criteria for the area you are located. Include the hot water heater in the mechanical room and size to meet the demands of the kennel. Allow for location of electrical panels in this area as well. Although a recommended size is shown on the plans, the room should be sized to support the equipment required for the location.

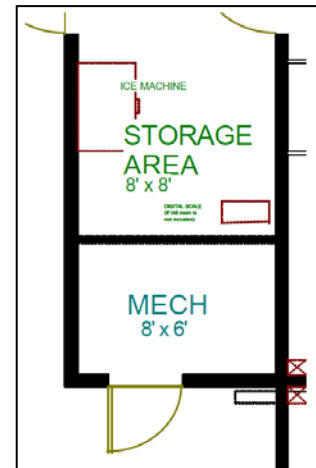

Figure K-23.--  
Storage/Mech  
Rooms

8. Renovations Considerations. Design renovation projects to incorporate as many of these guidelines as logical and practical into the MWD facility. In most cases the cost of the renovation should not exceed 70% of the cost for a new MWD facility. Serious consideration for new facilities or a reduction in the scope of the renovation should be given when renovation costs near the 70% mark. Don't neglect the impact to cost that environmental hazards (e.g., asbestos and lead based paint) will have on the project as well.

9. Optional Facility Designs. The following facility designs should be considered when funding and level of activity justify:

a. Spectator Facilities. Often the obstacle course is used to showcase the MWD Program during base tours so a covered viewing area for these events would be beneficial. Ideally aluminum bleachers on a concrete pad that sits 60 people would cover the requirement. Amenities would include drinking fountains, public address system, walks and bus parking.

b. VCO Treatment Area. In remote locations it may be advantageous to include in the veterinary treatment area an operating room and a x-ray room. The operating room would be 144 square feet and include wall and base cabinets (lockable), sinks and counters. Close coordination with the veterinarian office on all requirements including equipment would be a mandatory action at the beginning of the project.

c. Training Areas. If space allows, additional training structures can be added to the project. Examples would include out of commission vehicles for searches and simple building structures with rooms simulating different facilities that would be expected to be searched in the area.

d. MWD Cleaning Feature. In the kennel area, particularly if the veterinary treatment room is not included in the design, a dip tank or tub area for MWD bathing and cooling can be included in the project.

e. Drug Training Aid Storage. In many cases it is more advantageous to store drugs (narcotics) used as training aids at the MWD facility. The drug training aids should be stored in a GSA approved safe/container. Ideally the safe/container should be located in a storage room dedicated for this purpose, but the closet in the kennel master office, the trainer's office or space within the tack room could also serve as a storage area. Access to the storage room should be limited to as few people as possible. The room used to store drug training aids should be protected with an Intrusion Detection System (IDS) or be staffed by an armed guard 24 hours a day. Where 24 hours a day staffing is not possible, the following additional measures are required:

(1) Limit the number of entry points providing access to the storage room to the minimum possible.

24 FEB 2020

(2) Entry doors should be solid metal or wood doors or covered with nine to twelve-gauge security screening or 16-gauge sheet metal, fastened with smooth head bolts and nuts, pinned in place.

(3) Hinges should be mounted to the inside of the door with non-removable pins. Doors must be secured with a high security lock when not in use.

(4) All window providing access to the storage room must be protected by nine to twelve-gauge security screening or 3/8-inch or larger diameter steel bars spaced no more than six inches apart. The frames holding the screen or bars must be fastened to the window frame with smooth head bolts.

(5) Vents, crawl spaces and ceilings surrounding the storage room must not allow access to the storage room. Any opening larger than 96 square inches must be covered with nine to twelve-gauge security screen or steel mesh. The screens or mesh must either be welded to the frame of the opening or secured with smooth head bolts pinned in place.

(6) Walls, floors and ceilings of the storage room must provide a degree of protection equivalent or better than the reinforced doors and protected window.

(7) Coordinate additional requirements with local Security Forces.

**TAB K1**

Obstacle Course

**Table of Contents**

<u>IDENTIFICATION</u>	<u>TITLE</u>	<u>PAGE</u>
<b>SECTION</b>		
I	Requirement.....	K1-1
II	Construction.....	K1-1
III	Course Layout.....	K1-2
IV	A-Frame.....	K1-3
V	Barrels.....	K1-4
VI	Dog-Walk.....	K1-5
VII	Hurdles.....	K1-6
VIII	Stairs/Steps.....	K1-7
IX	Tunnel.....	K1-8
X	Window Hurdle.....	K1-9

**SECTION I - REQUIREMENT**

As required in Appendixes B and D, the following obstacles, as described in this tab, are required for MWD basic skills qualification:

- A-Frame
- Barrels (3)
- Dog-Walk
- Hurdles (3)
- Stairs/Steps
- Tunnel
- Window Hurdle

**SECTION II - CONSTRUCTION**

Obstacles should not have sharp edges or other features that could cause injury to MWDs. Materials include concrete, wood and weather resistant polyvinylchloride. Keep obstacles in good repair and select material based on life cycle cost. Wood obstacles require either two coats of resin or two coats enamel paint or one coat of marine varnish. Refer to DA Pamphlet 190-12 for more information on dimensions and size. If space permits, advanced obstacles such as a teeter-totter, tunnel on chains, rope bridges, for example, can be included to enhance training.

**SECTION III - COURSE LAYOUT**

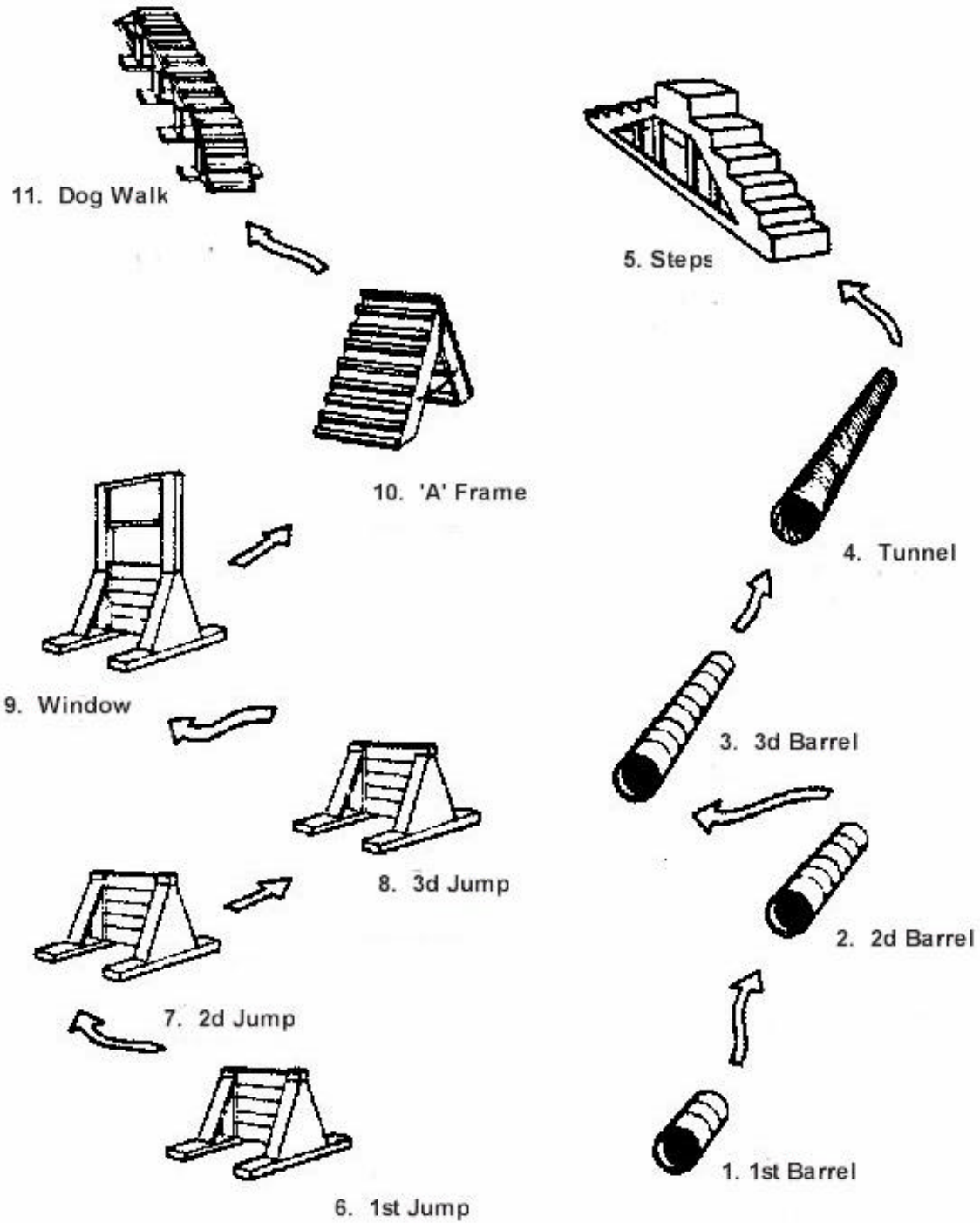

Each obstacle is 15 to 20 feet from previous obstacle and course runs in sequence.

**SECTION IV - A-FRAME**

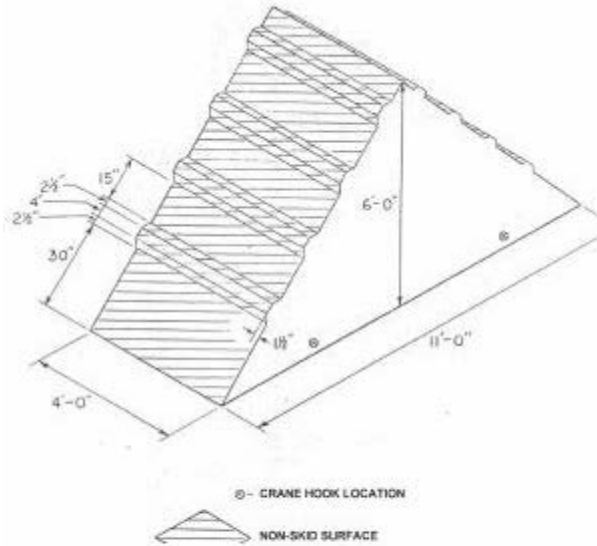

**CONCRETE "A" FRAME**

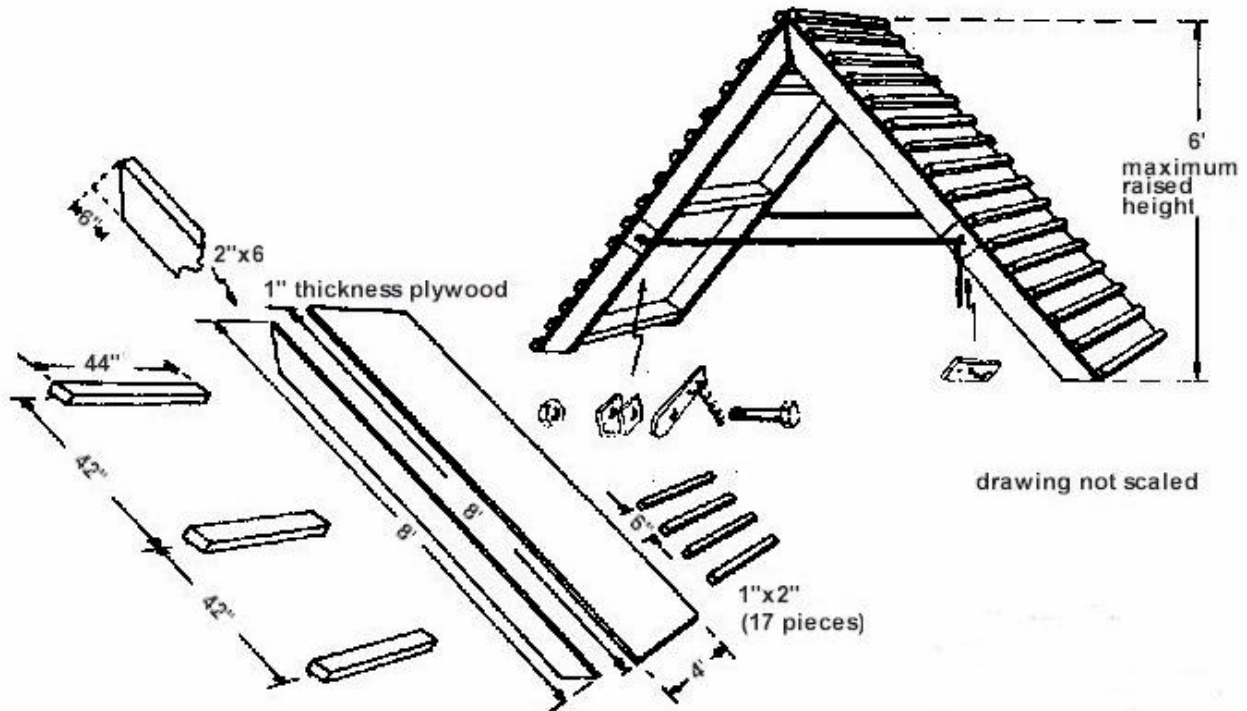

**WOOD "A" FRAME**

Length - 10 feet (8 feet on each side)  
 Width - 4 feet  
 Maximum raised height - 8 feet  
 Adjustable from horizontal position to the maximum allowable of 6 feet

**SECTION V - BARRELS**

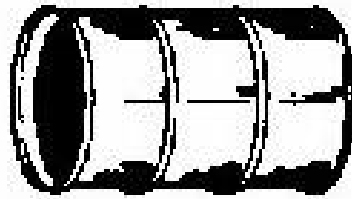

**Barrel No. 1**

**Length = 35 inches  
Opening = 23 inches**



**Barrel No. 2**

**Length = 70 inches  
Opening = 23 inches**

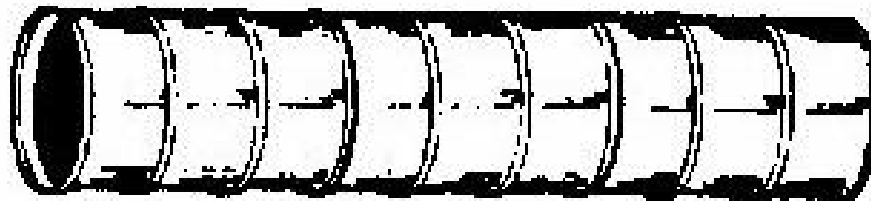

**Barrel No. 3**

**Length = 105 inches  
Opening = 23 inches**

**SECTION VI - DOG-WALK**

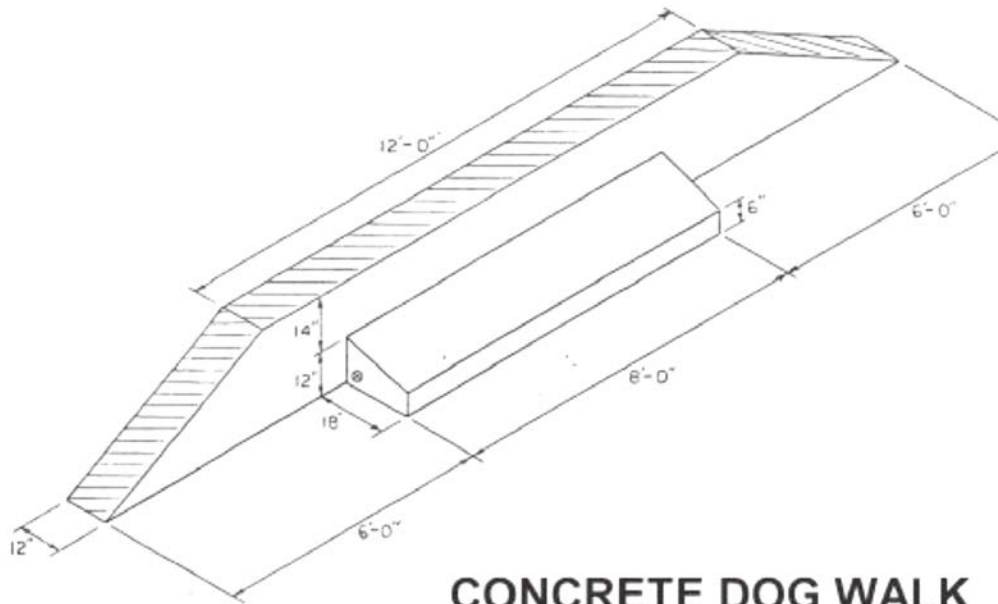

**CONCRETE DOG WALK**

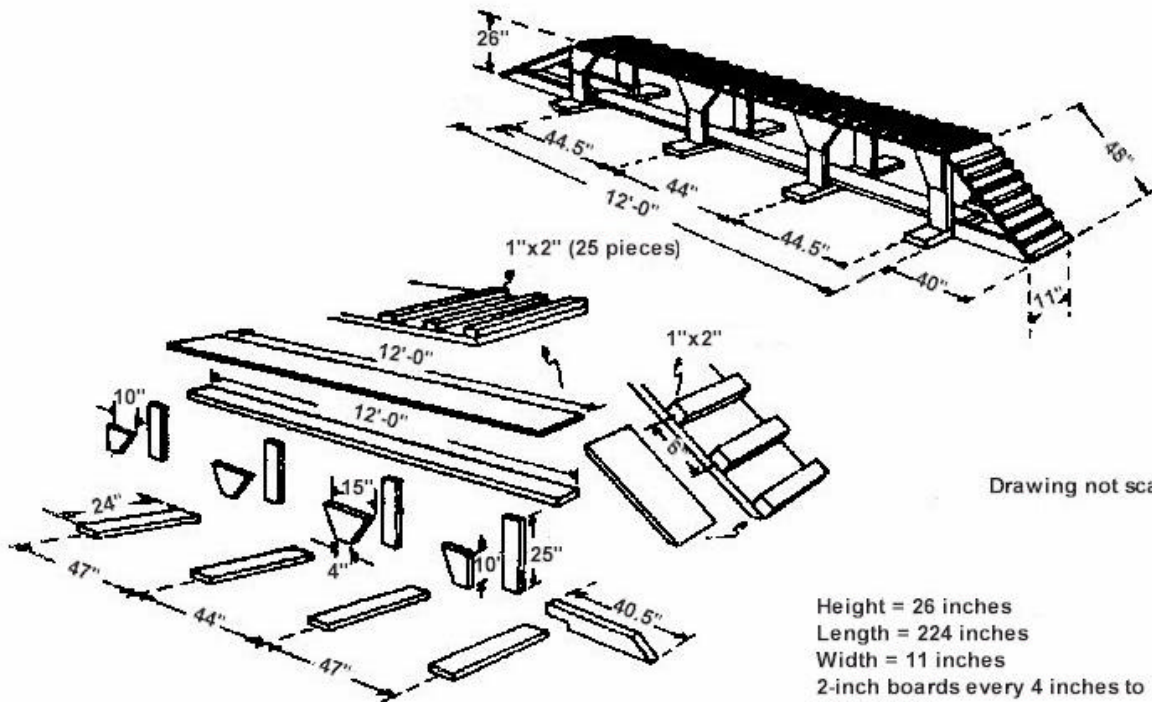

Drawing not scaled

Height = 26 inches  
Length = 224 inches  
Width = 11 inches  
2-inch boards every 4 inches to insure safe footing  
Ramp on each end of walk, 11 inches wide, 40 inches long (To be included in total 224-inch overall measurement)

**WOOD DOGWALK**



**SECTION VII - HURDLES**

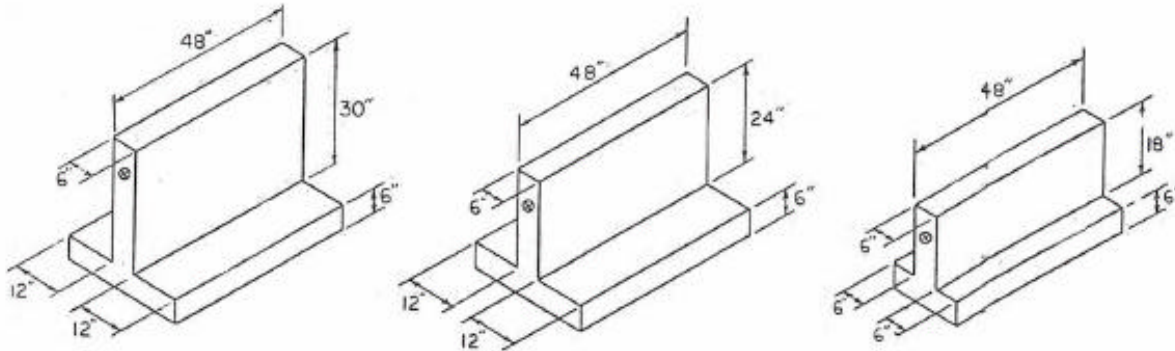

**CONCRETE HURDLES**

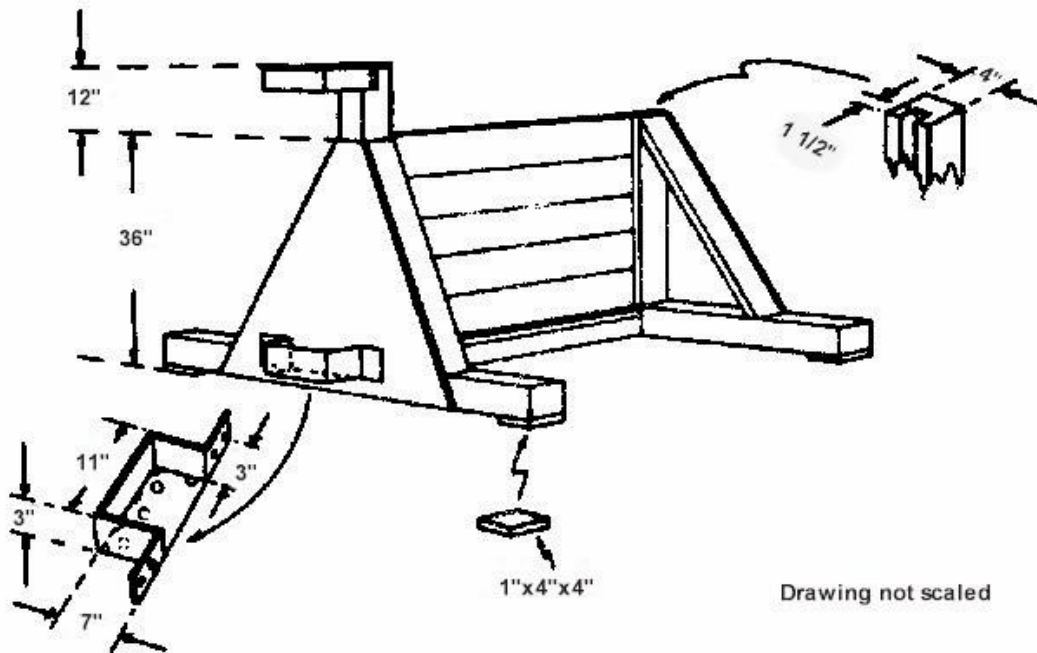

Height of maximum raised level for dog to negotiate = 36 inches  
Number of removable boards = 6  
Length of 6 boards, each = 51 inches  
Height of 6 boards each = 6 inches  
Thickness of each board = 1 inch

**WOOD JUMPS 1, 2, and 3**

**SECTION VIII - STAIRS/STEPS**

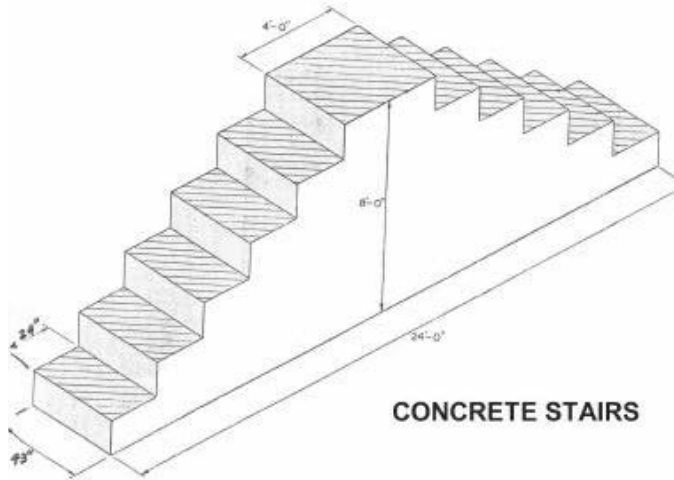

**CONCRETE STAIRS**

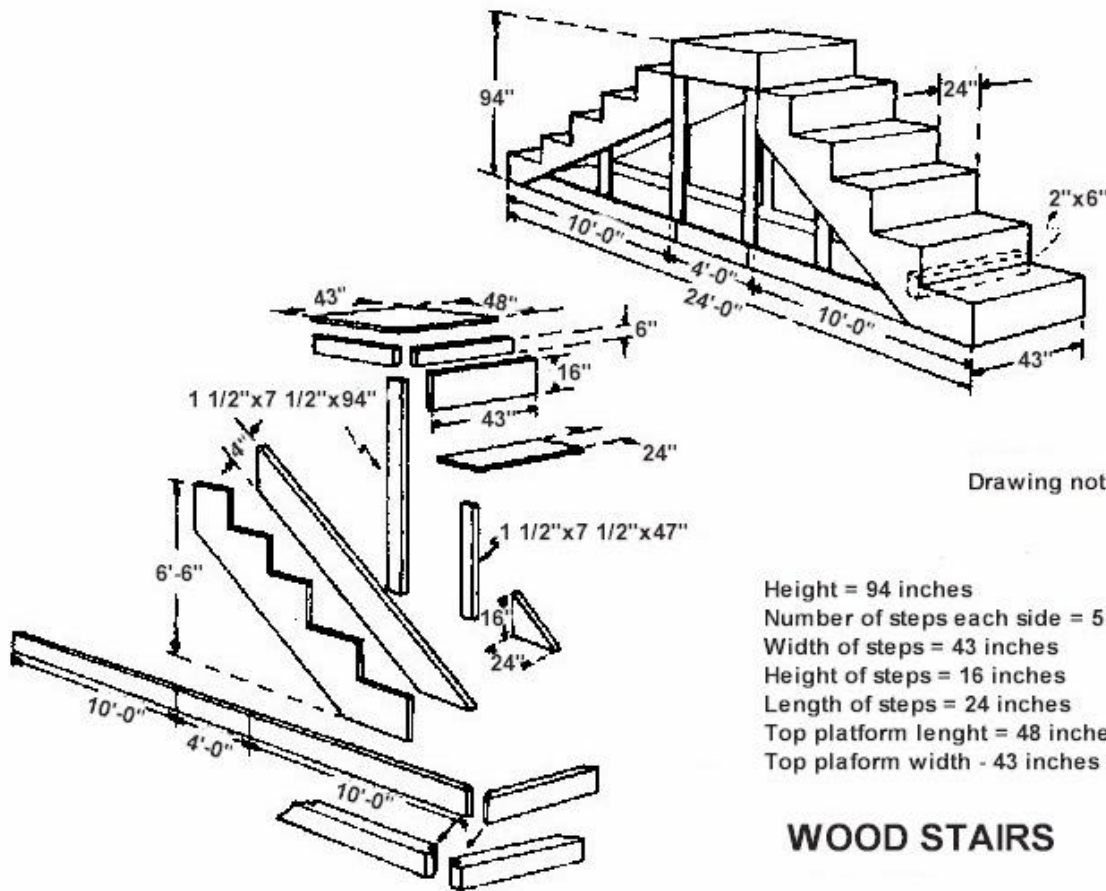

Drawing not scaled

- Height = 94 inches
- Number of steps each side = 5
- Width of steps = 43 inches
- Height of steps = 16 inches
- Length of steps = 24 inches
- Top platform length = 48 inches
- Top platform width = 43 inches

**WOOD STAIRS**

**SECTION IX - TUNNEL**

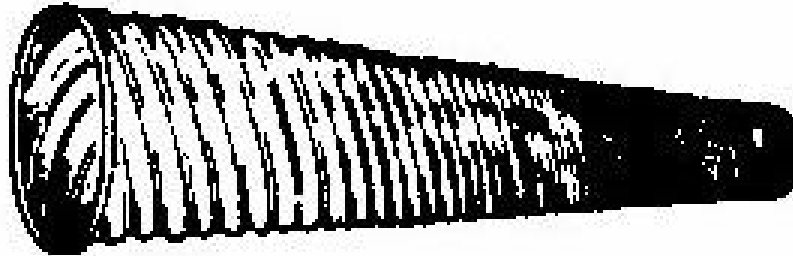

**Tunnel**

**Length = 146 inches  
Opening = 19 inches**

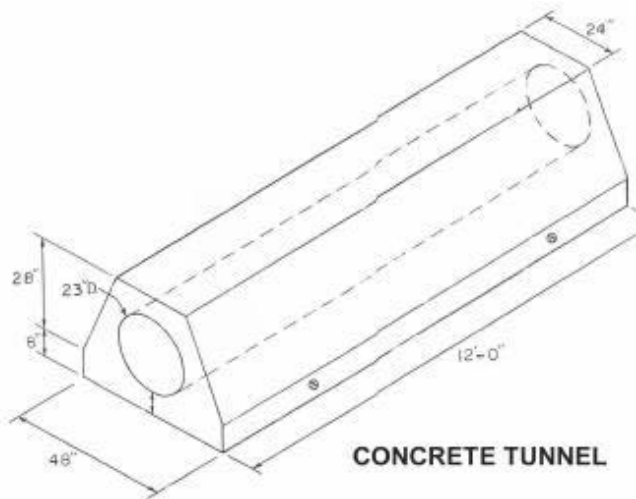

**SECTION X – WINDOW HURDLE**

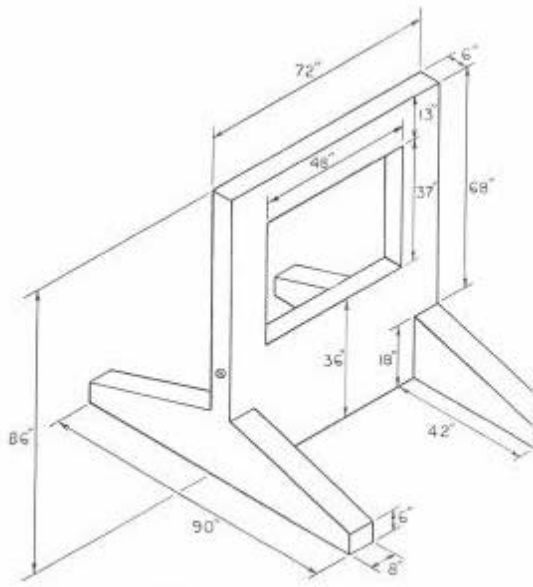

**CONCRETE WINDOW**

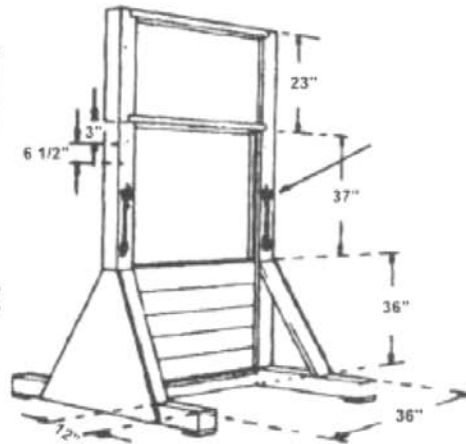
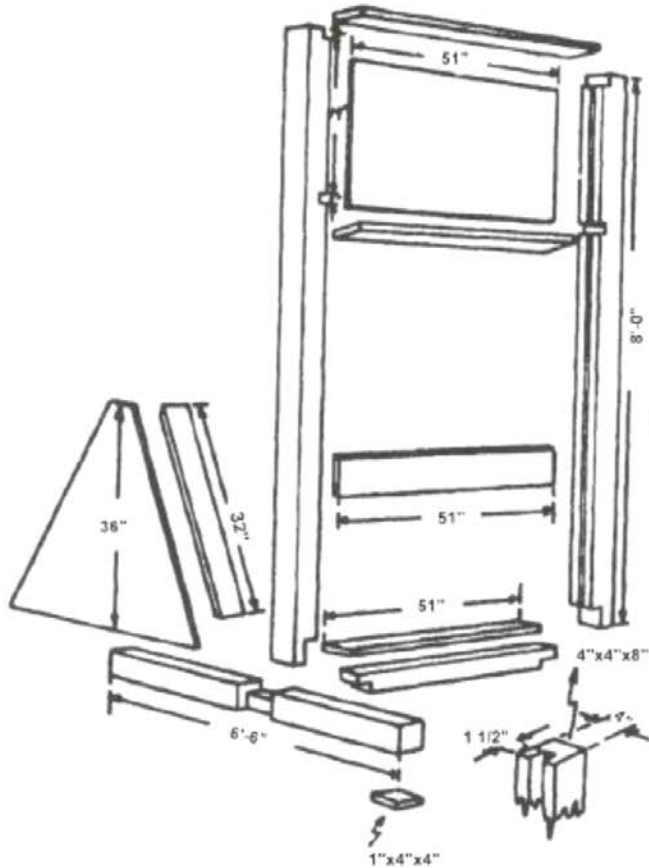

Height = 8 feet  
Maximum height for dog to negotiate = 36 inches  
Number of removable boards = 7  
Width of window opening = 48 inches  
Length of removable boards = 51 inches  
Thickness of removable boards = 1 inch

**WOOD WINDOW**

TAB K2

Example Kennel Facility Plans

Table of Contents

<u>IDENTIFICATION</u>	<u>TITLE</u>	<u>PAGE</u>
<b>Figures</b>		
K2-1	Interior Working Areas.....	K2-1
K2-2	Combination Indoor / Outdoor Kennel....	K2-2
K2-3	Indoor Or Outdoor Kennel.....	K2-3



Figure K2-1.--Interior Working Areas

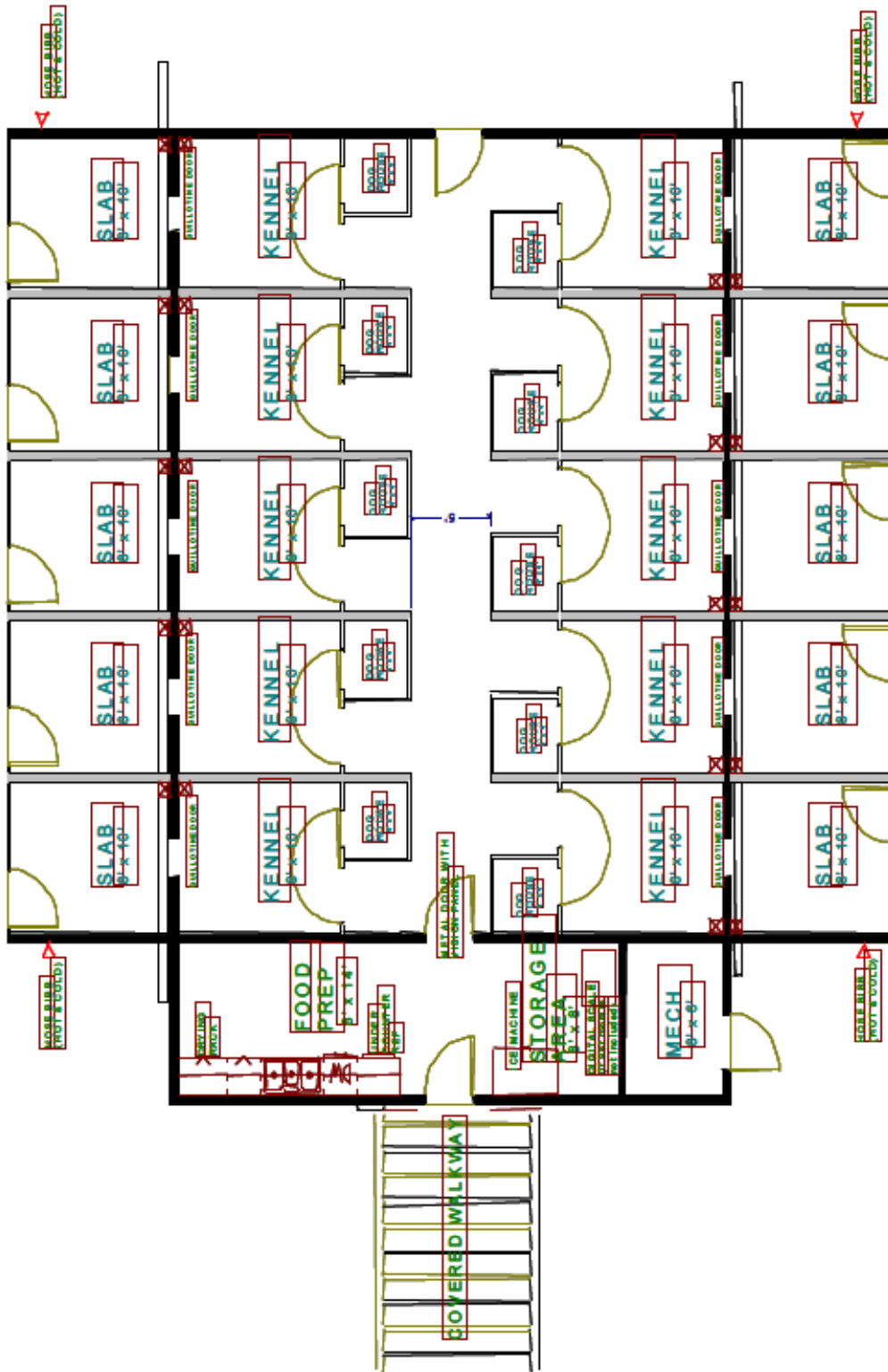

Figure K2-2.--Combination Indoor / Outdoor Kennel

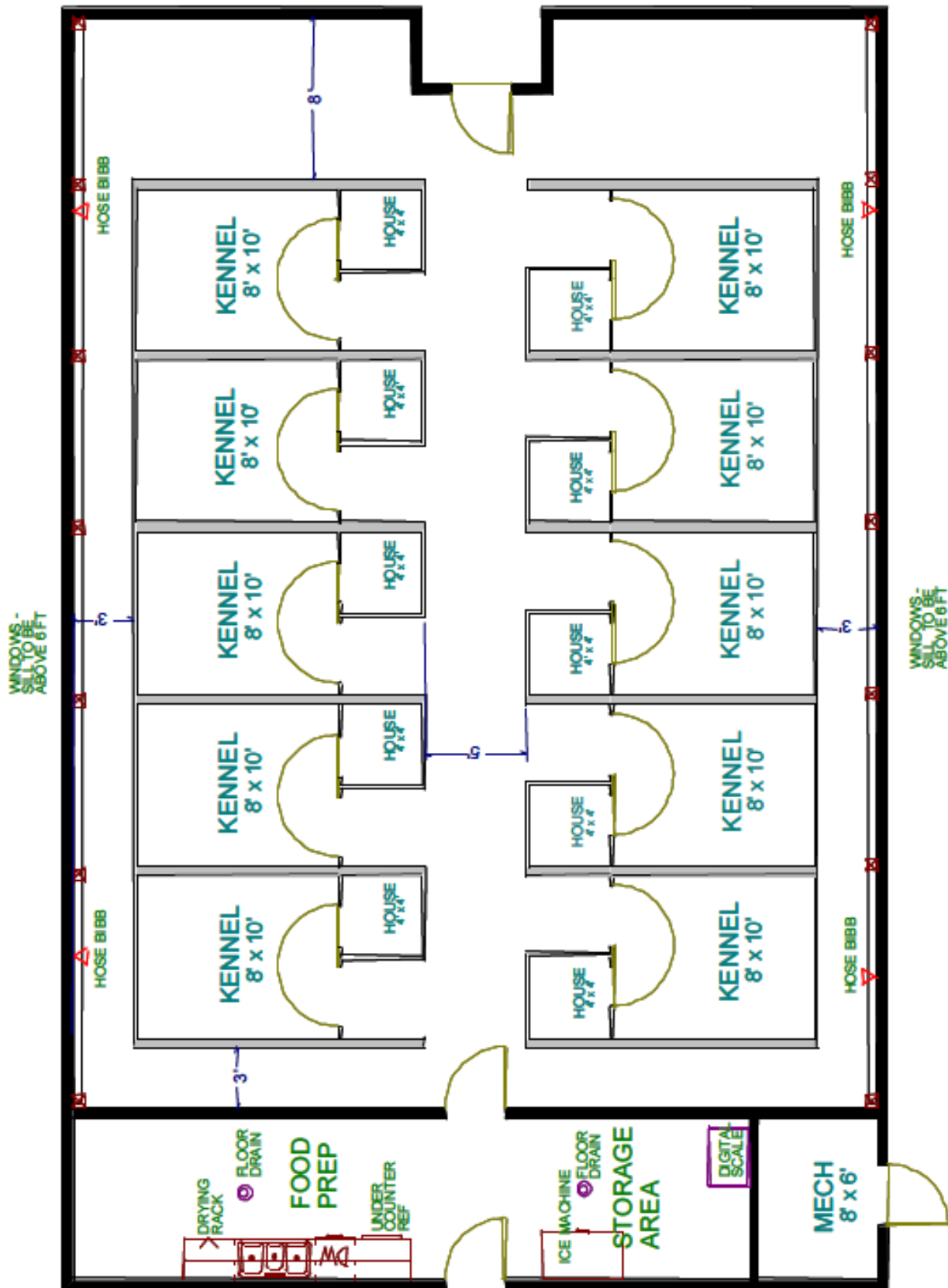

Figure K2-3.--Indoor Or Outdoor Kennel

**APPENDIX L**

Canine Drug Scent Kit (CDSK)

**Table of Contents**

<u>IDENTIFICATION</u>	<u>TITLE</u>	<u>PAGE</u>
<b>PARAGRAPH</b>		
1	Purpose.....	L-1
2	Introduction.....	L-1
3	CDSK Allowance.....	L-2
4	CDSK Configuration.....	L-2
<b>FIGURES</b>		
L-1	Example Kennel Facility Site Plan	L-4
<b>TABLES</b>		
L-1	USMC Canine Drug Scent Kit Allowance.....	L-2
L-2	USMC Canine Drug Scent Kit Configuration.....	L-3

1. Purpose. To provide information concerning the authorized allowance and configuration of the CDSK utilized by the Marine Corps.

2. Introduction. Chapter 11 identifies the requirement for drug training aids along providing the policy and procedures associated with obtaining and maintaining the CDSK. The term "CDSK" represents all the required drug training aids in a configuration approved by the MWD PM. The number of CDSKs varies by the size of the MWD section. Although termed as a "kit", the CDSK does not have an NSN identifier nor distributed as a contained end item of all training aids, but instead, is shipped to the MWD section as individual components. It is the receiving command's responsibility to store the components in a specified secure safe when not in use for MWD training. With this individual configuration, unserviceable components can be returned and replaced without impacting the control integrity or identification of the whole kit.



3. CDSK Allowance. Table L-1 provides a listing of Marine Corps commands authorized to receive and maintain the CDSK.

<b>Table L-1.--USMC CDSK Allowance</b>		
<b>Organization</b>	<b>Location</b>	<b>Allowance</b>
I MEF, LE Bn, MWD Plt.	MCB, Camp Pendleton, CA	1
II MEF, LE Bn, MWD Plt.	MCB, Camp Lejeune, NC	1
III MEF, LE Bn, MWD Plt.	Camp Butler, Okinawa, Japan	1
PMO, MWD Section	MAGTFTC, 29 Palms, CA	1
PMO, MWD Section	MCAS, Beaufort, SC	1
PMO, MWD Section	MCAS, Cherry Point, NC	1
PMO, MWD Section	MCAS, Iwakuni, Japan	1
PMO, MWD Section	MCAS, Miramar, CA	1
PMO, MWD Section	MCAS, Yuma, AZ	1
PMO, MWD Section	MCB, Camp Butler, Okinawa	1
PMO, MWD Section	MCB, Camp Lejeune, NC	1
PMO, MWD Section	MCB, Camp Pendleton, CA	1
PMO, MWD Section	MCB, Hawaii, HI	1
PMO, MWD Section	MCB, Quantico, VA	1
PMPD, MWD Section	MCLB, Albany, GA	1
PMPD, MWD Section	MCLB, Barstow, CA	1
PMO, MWD Section	MCRD, San Diego, CA	1
School of Infantry (SOI) West, Advanced Infantry Training Bn, USMC MWD Team Deployment Course	YPG, Yuma, AZ	1
<b>TOTAL</b>		<b>18</b>

4. CDSK Configuration. Table L-2 provides the authorized CDSK configuration by the substance, weight and quantity. Figure L-1 provides details about the typical drug aid.

Table L-2.--USMC CDSK Configuration					
Schedule	Code	Controlled Substance	Drug Weight (Grams)	Quantity	Total Weight (Grams)
		Blank Bag		1	0
		Blank Tins		2	0
			<b>Total</b>	<b>3</b>	<b>0</b>
1	7360	Marijuana	3	2	6
			5	2	10
			10	2	20
			20	4	80
			<b>Total</b>	<b>10</b>	<b>116</b>
1	7405	MDMA	1	1	1
			2	1	2
			3	1	3
			<b>Total</b>	<b>3</b>	<b>6</b>
1	9200	Heroin	1	2	2
			2	2	4
			3	1	3
			5	1	5
			<b>Total</b>	<b>6</b>	<b>14</b>
2	9041	Cocaine	1	2	2
			2	2	4
			3	2	6
			5	1	5
			<b>Total</b>	<b>7</b>	<b>17</b>
2N	1105	Methamphetamine	2	2	4
			3	2	6
			5	2	10
			<b>Total</b>	<b>6</b>	<b>20</b>
<b>Grand Total</b>				<b>35</b>	<b>173</b>



**Typical AFMES Shipping Package**

**Sealed Shipping Aid**

**Package:** AFMES ships the drug training aid in a sealed package to minimize odor contamination. The substance type and quantity is marked on the outside. Each package must be opened and contents confirmed by the custodian on receipt.

If opened by cutting the end, the package can be reused as a protective sleeve in the ammo can.

**NOTE:** MDMA requires the use of desiccant packages in storage to minimize evaporation of substance (included with shipment).

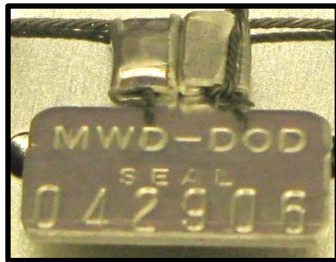

**Disc Seals with Wires:** Each aid has a seal that is imprinted with the serial number and "MWD-DOD". The seals are used to secure the substance within the tin container/cotton cloth bag and provide identification and accountability.

Metal ID tag may be added to bag w/"MJ-size"



Training Aid Canister Color-Coding Legend		
White	○	Cocaine
Green	●	Blank
Red	●	Heroin
Yellow	●	MDMA
Blue	●	Methamphetamine



**Metal Containers:**

The container is a 3 oz. plain can, having holes for ventilation of substance odor.

**Cotton Cloth Bags:**  
The Marijuana aids are double bagged in 8 cm x 10 cm cotton cloth bags with a draw string.

**Do not write on or etch aids.**

Figure L-1.--Typical Drug Training Aid

**APPENDIX M**

Canine Explosive Authorization Package (CEAP)

**Table of Contents**

<u>IDENTIFICATION</u>	<u>TITLE</u>	<u>PAGE</u>
<b>PARAGRAPH</b>		
1	Purpose.....	M-1
2	Introduction.....	M-1
3	CEAP Navy and Marine Corps AINs.....	M-2
4	Explosive Training Aid Authorization.....	M-2
5	CEAP Configuration.....	M-2
6	Maintaining CLEAN/DIRTY Aids.....	M-5
7	Transportation Container.....	M-5
8	Inspection.....	M-6
9	CEAP Electrostatic Discharge (ESD) Hazard	M-6
10	Net Explosive Weight (NEW).....	M-7
<b>FIGURES</b>		
M-1	Canine Explosive Authorization Package (CEAP) - Example.....	M-2
M-2	Example CEAP Storage Box.....	M-5
M-3	Example CEAP Transportation Box.....	M-6
<b>TABLES</b>		
M-1	MWD Section CEAP.....	M-3
M-2	CEAP Configuration and Weights.....	M-4
M-3	CEAP Component Characteristics and Inspection Guide.....	M-8
<b>TABS</b>		
M1	NEW Computation Worksheet.....	M1-1

1. Purpose. To provide information concerning the authorized allowance, configuration and inspection of the Marine Corps explosive training aids within the Canine Explosive Authorization Package (CEAP).

2. Introduction. Chapter 12 identifies the requirement for explosive training aids along with providing policy and procedures associated with obtaining and maintaining the CEAP. The term "CEAP" represents all the required explosive training aids in a configuration approved by the MWD PM. The CEAP varies by the size of the MWD section, PMO or MEF. The CEAP does not have an NSN identifier since it is assembled and maintained by the supporting Ammunition Supply Point (ASP) per the appropriate Ammunition Information Notice(s) (AIN) listed in the next paragraph.

3. CEAP Navy and Marine Corps AINs

016-2013 Canine Explosive Scent Kit (DODIC MN01)  
Disposition And Requirement Of The Replacement  
Military Working Dog (MWD) Canine Explosive  
Authorization Package (CEAP) (1375-  
MN01,MY77,M670,M023,M030,M031,M456, M585,DWDR;  
1376-MY57)

017-2013 Electrostatic Discharge (ESD) Hazard and  
Canine Explosive Authorization Package (CEAP)  
(1375-M670, M023, M030, M456, M585, DWDR;  
1376-MY57)

4. Explosive Training Aid Authorization. Table M-1 provides a listing of Marine Corps commands authorized to receive the CEAP.

5. CEAP Configuration. The CEAP, as illustrated in figure M-1, is composed of different samples of common explosives, defined in table M-2, used to train MWDs to detect explosives. The samples are packaged in individual portable munitions containers, by component type, as provided by the ASP. The CEAP component characteristics are provided in table M-3.

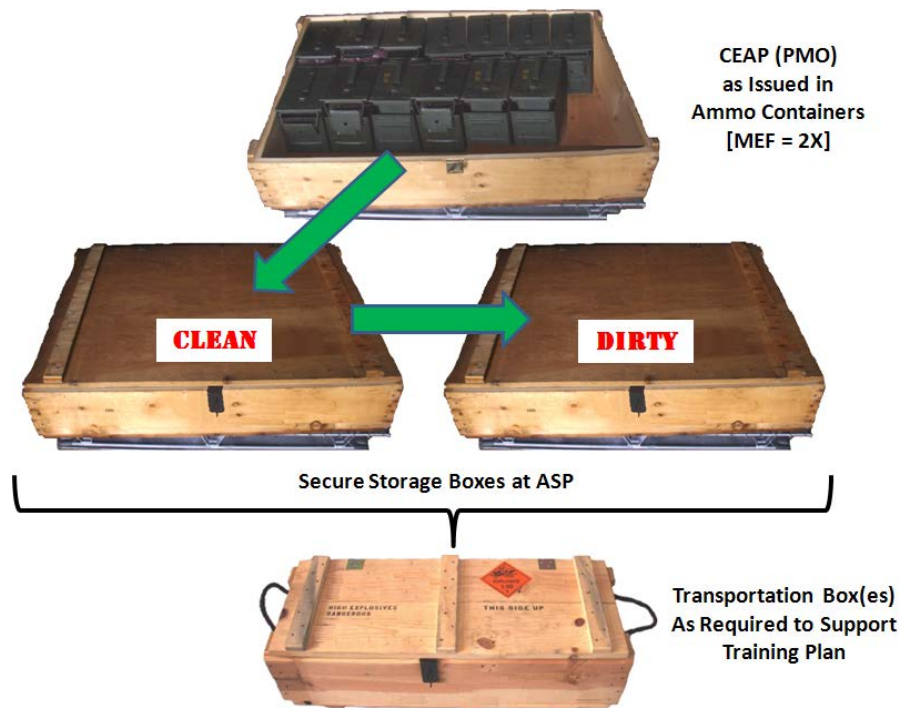

Figure M-1.--Canine Explosive Authorization Package (CEAP)  
- Example

<b>Table M-1.--MWD Section CEAP</b>		
<b>MSC</b>	<b>UIC</b>	<b>UNIT WITH MWD SECTION</b>
<b>MEF Authorization - Table M-2 (1) (2)</b>		
MARFORPAC	M20370	1ST LE Bn, I MEF
MARFORLANT	M20251	2ND LE Bn, II MEF
MARFORPAC	M20120	3RD LE Bn, III MEF
<b>PMO Authorization - Table M-2 (1) (2)</b>		
MCICOM	M02001	MCAS Cherry Point, NC
MCICOM	M02032	MCAS Beaufort, SC
MCICOM	M38441	MCLB Albany, GA
MCICOM	M93064	MCB Lejeune, NC
MCICOM	M00070	MCB Hawaii, HI
MCICOM	M02501	MCAS Iwakuni, Japan
MCICOM	M20270	MCB Butler, Okinawa, Japan <b>(3)</b>
MCICOM	M33120	SEC BN MCB CPEN, CA
MCICOM	M35010	H&S BN MAGTF TRNG COM, 29 Palms, CA
MCICOM	M62974	MCAS Yuma, AZ
MCICOM	M67865	MCAS Miramar, CA
MCICOM	M20970	MSOSG, NC
MCICOM	M00260	MCAF MCCDC, Quantico (HMX-1), VA
MCICOM	M34000	MCRD SD, CA
MCICOM	M93012	SEC BN MCCDC, MCB Quantico, VA
MCICOM	M38010	MCLB Barstow, CA <b>(3)</b>
TECOM	M33250	SOI-West, Advanced Infantry Training Bn, YPG, AZ
<b>Notes:</b>		
<p>(1) TAMIS authorization is identified by the total explosive component requirement for the CEAP defined for each MWD section in table M-2.</p> <p>(2) MWD sections will maintain CLEAN and DIRTY explosive training aids.</p> <p>(3) Due to command storage restrictions, locations may not be able to receive a full CEAP, in which case, the KM will have to request a CEAP (-) with a selection of all required explosive components, but in reduced quantities.</p>		

24 FEB 2020

<b>TABLE M-2.--CEAP Configuration and Net Explosive Weights (NEW)</b>									
<b>SYM</b>	<b>EXPLOSIVE COMPONENT</b>	<b>DODIC</b>	<b>HAZARD CLASS</b>	<b>AID SIZE</b>	<b>CEAP AIDS PER COMMAND</b>		<b>AID NEW</b>	<b>TOTAL NEW</b>	
					<b>PMO</b>	<b>MEF</b>		<b>PMO</b>	<b>MEF</b>
<b>C4</b>	C-4	M023	1.1D	1-1/4 Lbs Block	10	20	1.25	12.50	25.00
<b>DC</b>	Detonating Cord, PETN	M456	1.1D	10 Ft Length	6	12	0.07	0.42	0.84
<b>EM</b>	Emulsion, Dyno AP	DWDR	1.1D	1/2 Lbs Stick	18	36	2.00	36.00	72.00
<b>ND</b>	Nitroglycerin Dynamite	M587	1.1D	1/2 Lbs Stick	18	36	0.50	9.00	18.00
<b>SP</b>	Smokeless Powder	MY57	1.4C	1 Lbs Can	6	12	1.00	6.00	12.00
<b>TF</b>	Time Fuse, Blasting	M670	1.4S	10 Ft Length	6	12	0.02	0.12	0.24
<b>TNT</b>	TNT, Trinitrotoluene	M030	1.1D	1/4 Lbs Block	40	80	0.25	10.00	20.00
<b>DODIC - Department of Defense Identification Code</b>									
<b>NOTE:</b> The National Stock Number (NSN) may vary depending on the inventory available at the time of issue.					<b>104</b>	<b>208</b>		<b>74.04</b>	<b>148.08</b>

6. Maintaining CLEAN/DIRTY Aids. The CEAP components will be issued in CLEAN condition [Munitions Condition Code A]. As explosive training aids are utilized, those that have been cross contaminated with other aids, soiled, and possibly been in direct human contact; will be identified as DIRTY aids and maintained separately from the original CLEAN aids. Overtime, the DIRTY aid collection can become the majority of the CEAP as long as there are sufficient CLEAN aids available for validation and certification purposes. DIRTY aids are not to be stored in the same containers with CLEAN aids. Figure M-2 illustrates how CEAP components are separated and labeled in storage.

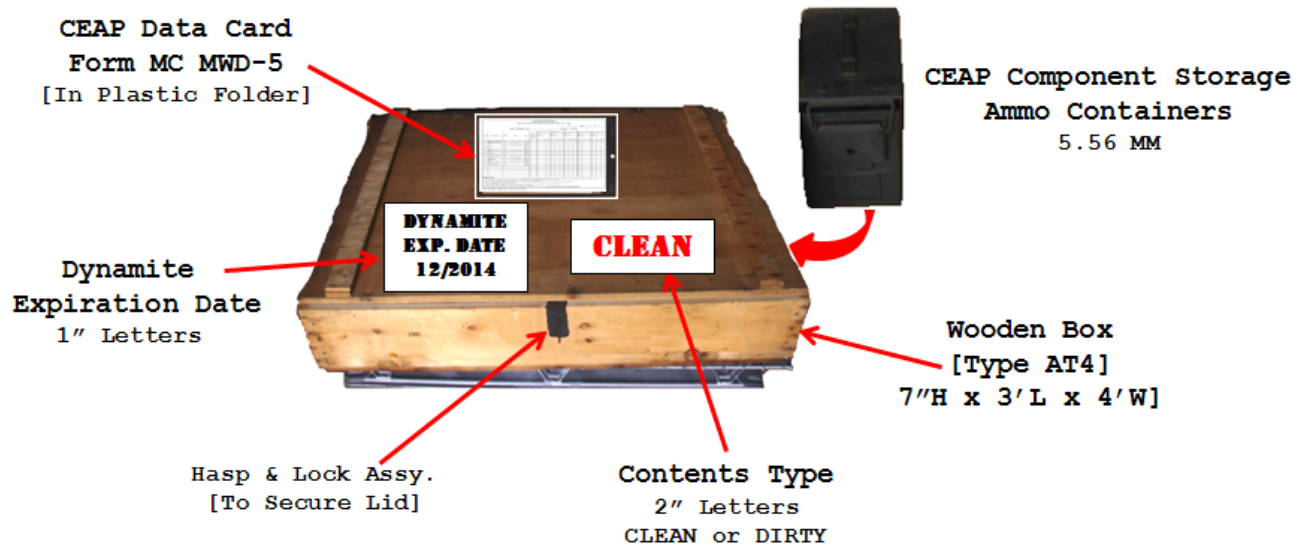

Figure M-2.--Example CEAP Storage Box

7. Transport Container. The KM will arrange for the construction of boxes suitable for transporting CEAP components per 49 CFR [for shipments over public and installation roadways]. Old serviceable MN01 scent kit boxes can be utilized. Figure M-3 illustrates an example transportation box. The following general guidance applies:

a. Construction. Each transport box should be constructed of durable wood suitable to carry at least 80 pounds. of contents. Handles should be attached to each end for ease of carrying by two people.

b. Markings. The markings for all inner and outer containers will be applied per MIL-STD-129 and 49 CFR. Content type shown in figure M-3 can either be stenciled directly to the box or applied on a card that is attached on the lid. Each internal container will be identified with the name of the explosive component being carried. In the case of a recycled



**box, remove/blank out any markings that do not apply to the CEAP.**

c. Hasp Assembly. The lid shall be secured with a hasp that mechanically secures the lid from opening while in transit.

d. Supplies. Each box shall contain sufficient supplies (nitrile gloves, anti-static bags, etc.) to support the training.

e. References. A copy of this appendix should be carried in a plastic envelope attached to the lid interior for quick reference to inspection guidelines and NEW computation.

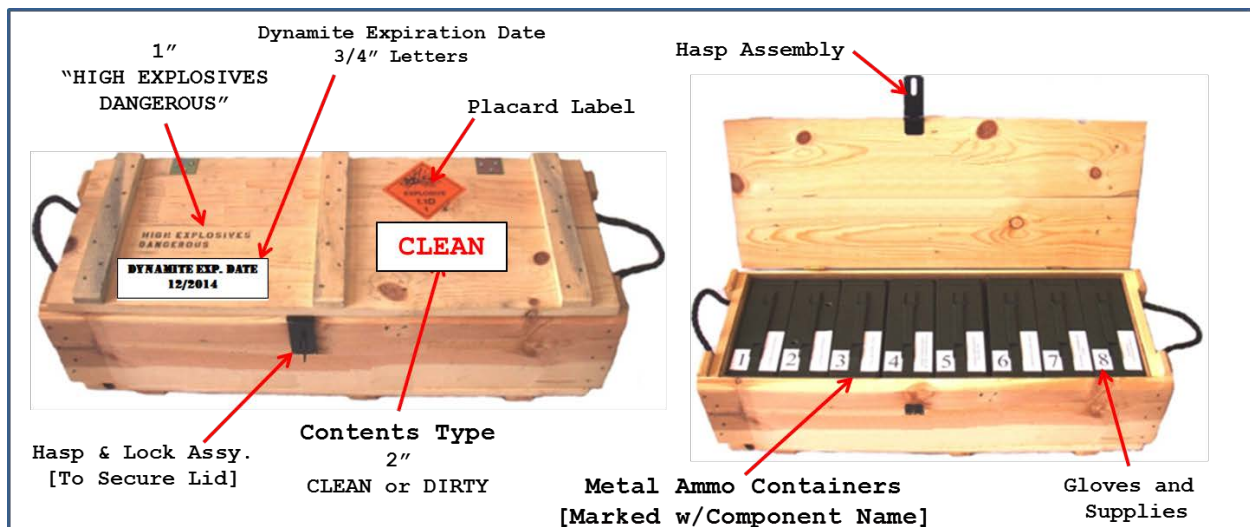

Figure M-3.--Example CEAP Transportation Box

8. Inspection. Since the CEAP is issued annually and the explosive components are stable, the risk of a critical defect is minimal, but it is imperative that each authorized user be diligent in visually inspecting each training aid before and after use. Table M-3 provides an inspection guideline for each CEAP component to include corrective action for common defects encountered other than destruction by the MWD. Any questions or concerns about an explosive aid condition shall be directed to an ASP technician for corrective action.



9. CEAP Electrostatic Discharge (ESD) Hazard. KMs shall ensure all personnel take the MWD Personnel Explosive Detection Safety Training annually to cover the ESD requirement from AIN 017-2013 (see table 12-1).



24 FEB 2020

10. Net Explosive Weight (NEW). NEW is a computed measure of relative effectiveness of a given compound. The NEW value of each CEAP component aid is listed in table M-2 along with the total value for the SE and MEF authorizations. NEW is an important factor when evaluating safe transportation loads, storage, and training event planning [see paragraph 12303]. TAB M1 provides a worksheet for computing the total NEW for training aid selection, which must be in compliance with the restrictions specified in table 12-2.

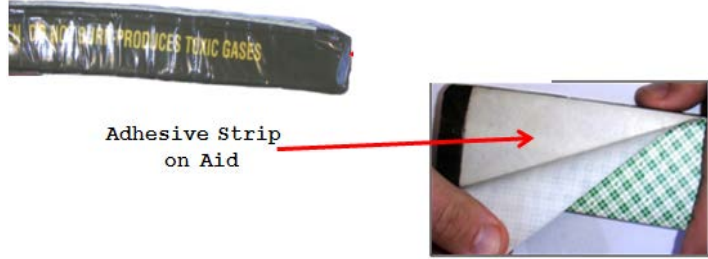
**CAUTION**

- ✓ Avoid touching any exposed explosives with bare hands.
- ✓ Any body part that is exposed to raw explosives should be washed as soon as possible.
- ✓ CEAP components will not be cut or altered from the issued size. MOS 5812s do not modify explosives. Correct CEAP lengths must be requested in TAMIS and modified as required by explosive technicians.
- ✓ The use of duct tape on aids should be restricted to avoid MWD detection issues.

<b>Table M-3.--CEAP Component Characteristics and Inspection Guide</b>		
<b>C-4</b>		
<b>C-4</b>	<b>M023</b>	 <p style="text-align: center;">Adhesive Strip on Aid</p>
<b>Characteristics</b>		
<ol style="list-style-type: none"> <li>1. The Composition C4 is a rectangle-shaped block weighing roughly 1-1/4 pounds.</li> <li>2. It is enclosed in an olive-drab plastic bag and sealed with a metal clip.</li> <li>3. There is a two-inch strip of pressure sensitive tape with a paper cover liner protecting the adhesive.</li> <li>4. Composition C-4 is more powerful than TNT.</li> </ol>		
<b>Defect</b>		<b>Corrective Action</b>
Damage to plastic bag that exposes C4		Contact ASP for aid replacement.
Less than full charge (cut charge)		
Pressure sensitive tape missing, damaged, liner removed		
<b>DETONATING CORD, PETN</b>		
<b>DC</b>	<b>M456</b>	
<b>Characteristics</b>		
<ol style="list-style-type: none"> <li>1. The Detonating Cord consists of a core of high explosives (PETN) wrapped in a reinforced and waterproof olive drab plastic coating that is used to prime and detonate single or multiple explosive charges simultaneously.</li> <li>2. Detonating cord alone functions as an explosive charge.</li> <li>3. The outer sheath may be plastic/textile in solid/striped color and is manufactured under brand names such as "Primacord," "Detacord," "Detonating Fuse," "Cordeau Detonate," or "Cord Tex".</li> </ol>		
<b>Defect</b>		<b>Corrective Action</b>
Kinks and sharp bends of detonating cord		Lay out cords as straight as possible without stretching taut and remove kinks.
Splits, cracks, punctures, perforations		Contact ASP for aid replacement.
Exposed explosives ends		Contact ASP for repair.

<b>Table M-3.--CEAP Component Characteristics and Inspection Guide</b>		
<b>EMULSION, Dyno AP</b>		
<b>EM</b>	<b>DWDR</b>	
<p><b>CAUTION</b></p> <p>Always use latex gloves when handling leaky or wet Emulsion since the leaky substance is a health hazard.</p>		
<p><b>Characteristics</b></p> <ol style="list-style-type: none"> <li>1. Emulsion is a toxic liquid substance in plastic/foil wrapper.</li> <li>2. The plastic wrapper is easily punctured, especially when bent.</li> <li>3. The ends of the wrapper are tied with metal bands.</li> <li>4. These bands will cause small cracks and holes when handled rough.</li> <li>5. Emulsion components should be inspected while still in the anti-static bag.</li> <li>6. If there is any liquid in the bag, then there is a leak in one or more of the aids.</li> <li>7. Leaky Emulsion is the most common damaged training aid.</li> </ol>		
<b>Defect</b>		<b>Corrective Action</b>
Exudes explosive		Contact ASP for aid replacement.
<b>NITROGLYCERIN DYNAMITE</b>		
<b>ND</b>	<b>M587</b>	
<p><b>WARNING</b></p> <ol style="list-style-type: none"> <li>1. Dynamite sticks exuding <u>clear</u> or <u>brownish liquid droplets</u> are sensitive to shock and therefore dangerous to transport, and should be protected from high temperatures and severe drops and jolts.</li> <li>2. Avoid crushing, dropping, or rough handling.</li> </ol>		
<p><b>CAUTION</b></p> <p>It may produce severe headaches after a short period of contact. Although aspirin and other pain relievers have little effect on such headaches, some relief may be obtained by drinking black coffee.</p>		
<p><b>IMPORTANT</b></p> <p>Dynamite sticks <u>have to be rotated every 30 days</u>. See marking and rotation instructions below.</p>		

<b>Table M-3.--CEAP Component Characteristics and Inspection Guide</b>	
<b>Characteristics</b>	
<ol style="list-style-type: none"> <li>1. Unimax Dynamite has 26 to 28% of a 60-40 blend of nitroglycerin to EGDN (ethylene glycol dinitrate) with the balance being ammonium nitrate and sodium nitrate. EGDN is as volatile as nitro, but makes it useable in cold temperature.</li> <li>2. The finished product is pliable (various degrees of softness, depending on the temperature) and appears to be oily.</li> <li>3. Dynamite tends to be soft/mushy and feel oily. This is a normal condition. Unless the presence of exudates is noted, the dynamite should be considered serviceable.</li> <li>4. Exposure of this component to high temperatures can cause the stick to sweat or exude liquid droplets on the outer wrapping.</li> <li>5. Dynamite exudes both nitroglycerin and/or EGDN in the form of a liquid.</li> <li>6. The brownish liquid drops are nitroglycerin, which can form crystal-like powder on the outer wrapper.</li> <li>7. White crystals may form on the exterior of the wrapper. These crystals may be nitrate salts and are not evidence of exudation.</li> </ol>	
<b>Defect</b>	<b>Corrective Action</b>
Dynamite exudes a clear/brownish liquid that may crystallize or a residue that appears to be a white powder or a dust	Have ASP ammo tech inspect and turn-in if required.
Wet/damp, caked with mud or dirt	Clean and wipe dry.
<b>Dynamite marking, rotation and recording instructions:</b>	
<ol style="list-style-type: none"> <li>1. Mark all dynamite sticks with letters as shown below.</li> <li>2. Set one letter upward at the beginning of the month and turn the opposite letter upward at the beginning of the next month. Continue this process.</li> <li>3. When sticks are returned from training use, set the same letter upward that was recorded at the beginning of the month.</li> <li>4. Record rotation in the Explosive Daily Issue/Return Log [see Chapter 12 for sample log entry].</li> </ol>	

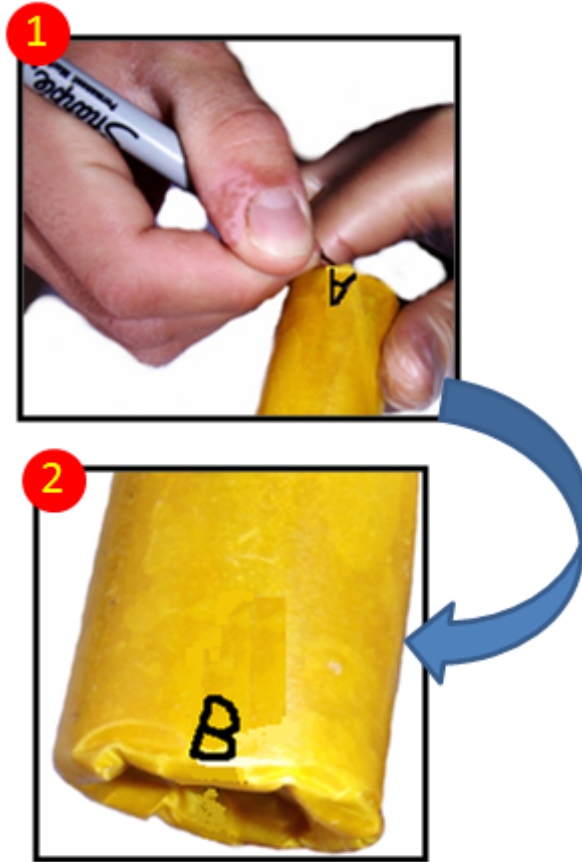

**Table M-3.--CEAP Component Characteristics and Inspection Guide**



**Applying rotation letters to dynamite training aid:**

Using fine point felt tip or ball point pen with black ink.

1. On one end of the stick, write a 1/4" letter "A".
2. Rotate the stick 180° and write a 1/4" letter "B".

<b>Table M-3.--CEAP Component Characteristics and Inspection Guide</b>		
<b>SMOKELESS POWDER</b>		
<b>SP</b>	<b>MY57</b>	
<b>Characteristics</b>		
<ol style="list-style-type: none"> <li>1. The Smokeless Powder is essentially a mixture of chemicals designed to burn under controlled conditions at the proper rate to propel a projectile from a gun.</li> <li>2. Unconfined, smokeless powder burns at a rate that increases with both temperature/pressure.</li> <li>3. For this reason, it is frequently used in fabricating pipe bombs.</li> </ol>		
<b>Defect</b>		<b>Corrective Action</b>
Damage to containers that exposes powder		Contact ASP for aid replacement.
Excessive rust/corrosion		
<b>TIME FUSE, BLASTING</b>		
<b>TF</b>	<b>M670</b>	
<b>Characteristics</b>		
<ol style="list-style-type: none"> <li>1. The Time Blasting Fuse consists of a black powder core encased in a dark green fiber wrapping that is covered with a waterproof plastic cover.</li> <li>2. It is marked with a single yellow band at 1-foot or 18-inch intervals and double yellow bands at 5-foot or 90-inch intervals.</li> <li>3. These markings are used to estimate the approximate lengths of fuse required for tactical situations.</li> <li>4. Time fuse is very sensitive to electro-static discharge and can be ignited by an ordinary match.</li> <li>5. Special care should be taken to ensure time fuse does not come in contact with water/moisture.</li> <li>6. Tape exposed ends of time fuse to prevent explosive from moisture contamination and from leaking out using authorized ordnance/duct tape.</li> </ol>		
<b>Defect</b>		<b>Corrective Action</b>
Yellow marks missing		Contact ASP for aid replacement.
Splits, cracks, punctures, perforations		
Exposed explosive		Contact ASP for repair.
Kinks and sharp bends of time blasting fuse		Unwound and lay out time blasting fuse straight without stretching taut to remove kinks.
Unwound or loose cord		Ensure the blasting fuse is wound properly as the cord tends to form a spiral when unwound.

<b>Table M-3.--CEAP Component Characteristics and Inspection Guide</b>		
<b>TNT, TRINITROTOLUENE</b>		
<b>TNT</b>	<b>M030</b>	
<p><b>CAUTION</b></p> <p>TNT can be absorbed through the skin, causing headaches, anemia, and skin irritation.</p>		
<p><b>Characteristics</b></p> <ol style="list-style-type: none"> <li>1. The TNT is enclosed in an olive drab water-resistant fiberboard container having metal end closures.</li> <li>2. One end is provided with a cap well to receive a blasting cap.</li> <li>3. The cap well is threaded to receive a priming adapter or the standard coupling base on a firing device.</li> <li>4. TNT charges have a high detonating velocity, and can be used underwater.</li> </ol>		
<b>Defect</b>		<b>Corrective Action</b>
TNT exudes (dark brown oily liquid)		Contact ASP for aid replacement.
Split, cracked, punctured, or perforated charges		



**TAB M1**

<b>NET EXPLOSIVE WEIGHT (NEW) COMPUTATION WORKSHEET CANINE EXPLOSIVE AUTHORIZATION PACKAGE (CEAP)</b>							
<b>SYM</b>	<b>EXPLOSIVE COMPONENT</b>	<b>DODIC</b>	<b>HAZARD CLASS</b>	<b>AID SIZE</b>	<b>AID NEW (A)</b>	<b>AID QTY (B)</b>	<b>TOTAL NEW (A x B)</b>
<b>C4</b>	C-4	M023	1.1 D	1-1/4 Lbs	1.25		
<b>DC</b>	Detonating Cord, PETN	M456	1.1 D	10 Ft Length	0.07		
<b>EM</b>	Emulsion	DWDR	1.1 D	1/2 Lbs Stick	2.0		
<b>ND</b>	Nitroglycerin Dynamite	M587	1.1 D	1/2 Lbs Stick	0.5		
<b>SP</b>	Smokeless Powder	MY57	1.4C	1 Lbs Can	1.0		
<b>TF</b>	Time Fuse, Blasting	M670	1.4S	10 Ft Length	0.02		
<b>TNT</b>	TNT, Trinitrotoluene	M030	1.1 D	1/4 Lbs Block	0.25		
<b>DODIC</b> - Department of Defense Identification Code			<b>TOTALS</b>				
<b>NOTE:</b> The National Stock Number (NSN) may vary depending on the inventory available at the time of issue.							

**APPENDIX N**

Canine Non-Explosive Training Aids

**Table of Contents**

<u>IDENTIFICATION</u>	<u>TITLE</u>	<u>PAGE</u>
<b>PARAGRAPHS</b>		
1	Purpose.....	N-1
2	Introduction.....	N-1
3	Receiving/Receipt of Non- Explosive Training Aids.....	N-2
4	Procurement.....	N-2
5	Configuration.....	N-2
6	Markings.....	N-3
7	Rotation Cycle.....	N-3
8	Storage.....	N-4
9	Disposition.....	N-5
<b>FIGURES</b>		
N-1	Nitrate Markings.....	N-6
N-2	Chlorate Markings.....	N-6
<b>TABLES</b>		
N-1	Non-Explosive Training Aid Configuration.....	N-3
N-2	Non-Explosive Training Aid Rotation Cycle.....	N-3
N-3	Non-Explosive Compound On-Hand Quantity.....	N-4

1. Purpose. To provide information about the configuration and procedures associated with the canine non-explosive training aids utilized by the Marine Corps.

2. Introduction. Chapter 12 of this Order identifies the requirement for non-explosive training aids along with providing policy and procedures associated with obtaining and maintaining the following oxidizing agents:

- Ammonium Nitrate
- Potassium Chlorate
- Sodium Chlorate

There is no uniquely identified kit for these training aids since the component oxidizers are locally available as commercial compounds that only require limited hazardous material controls. Both Clean/Dirty non-explosive training aids

are used in conjunction with the associated explosive training aids. Each oxidizer has a total recommended usable scent life of six months for MWD training purposes.

3. Receiving/Receipt of Non-Explosive Training Aids. The KM will file copies of open order documents, order delay MFRs (if applicable), and shipment/receiving documents for all non-explosive aids in the #5 Section folder of the Explosive Training Aid Accountability Folder (see figure 12-6). The annual turn-in of odor will be based off of the receiving date of the non-explosive compounds. If an aid is on-order but delivery is delayed, on-hand odor can be used until the new aid is received, as long as the manufacturer's expiration date has not passed. If the new aid is still on-order after the on-hand odor's expiration date, on-hand odor can be used for training purposes only, not for validation/certification events.

4. Procurement. Each MWD section with explosive detection MWDs is required to procure the required non-explosive compounds in a manageable volume and construct the quantity and size of individual training aids in accordance with the recommendation provided in this appendix. Chlorates/Nitrates are available through GSA chemical suppliers [listing of sources is available in the WDMS Library].

a. Chlorates. Chlorates are normally provided in amber colored glass bottles [minimum amount of 500 grams is recommended for storage purposes]. Chlorates should be laboratory grade with a high level of purity.

b. Ammonium nitrate. Normally, shipped in bags or plastic containers [minimum amount of 50 pounds is recommended].

5. Configuration. Table N-1 provides a recommended non-explosive training aid configuration and the minimum quantity that the MWD section shall maintain. Additional training aids can be assembled at the KM's discretion.

<b>Table N-1.--Non-Explosive Training Aid Configuration</b>			
<b>Oxidizer</b>	<b>SIZE</b>	<b>Minimum Aids Per MWD Section (2)</b>	
		<b>PMO</b>	<b>MEF</b>
Ammonium Nitrate	1 - 25 lbs.(1)	2	4
Potassium Chlorate	500 grams	2	4
Sodium Chlorate	500 grams	2	4
<b>NOTES:</b>			
(1) One or multiple aids can be constructed from the specified total amount.			
(2) Total aids clean and dirty.			

6. Markings. See figures N-1 and N-2 for markings to be utilized on storage containers and training aids.

**NOTE**

Each vendor container shall be marked with the delivery date. All chemicals shall be disposed of 12 months after the delivery date, regardless of the stated manufacturer's expiration date.

7. Rotation Cycle. Due to oxidizer rapid loss of odor from exposure to air or moisture, non-explosive training aids shall be replaced on the rotation schedule per table N-2.

<b>Table N-2.--Non-Explosive Training Aid Rotation Cycle</b>	
<b>Item</b>	<b>Rotation</b>
<b>Clean Aid</b>	0-90 Days [becomes Dirty Aid]
<b>Dirty Aid</b>	91-180 [becomes Aged Aid]*
<b>Aged Aid &gt;180 days</b>	<b>Disposal</b> - Annually [max] of all used aged chemical
<b>Unused Chemical - On hand &gt;12 months of delivery</b>	<b>Disposal</b> - Annually [max] with any used aged aids**
* <b>NOTE:</b> For the <u>initial</u> aid construction, it will be necessary to designate a new CLEAN aid as DIRTY to start the rotation cycle.	
** <b>NOTE:</b> Refer to paragraph 3 for exceptions when oxidizers may not be disposed of within one year of receipt.	

24 FEB 2020

8. Storage. The following requirements apply to storing non-explosive training aids:

a. On-Hand Quantity. Table N-3 provides the maximum quantity of non-explosive compound that should be maintained by an MWD section at any point in time.

<b>Table N-3.--Non-Explosive Compound On-Hand Quantity</b>		
<b>Non-Explosive Compound</b>	<b>Maximum On-Hand Quantity Per MWD Section (1)(2)</b>	
	<b>PMO</b>	<b>MEF</b>
Ammonium Nitrate	200 lbs	400 lbs
Potassium Chlorate	4000 grams	8000 grams
Sodium Chlorate	4000 grams	8000 grams
<b>NOTES:</b>		
<b>(1) Total of all on-hand chemical [aids, new, aged]</b>		
<b>(2) Equivalent of one year [max] usage.</b>		

b. Hazmat Locker. Storage of all non-explosive training aids [includes bulk chemicals, current training aids and aged aids] must be stored in an outdoor lockable storage container that is maintained per local HAZMAT procedures and the manufacturer's published Material Safety Data Sheet (MSDS) for each oxidizer. Contact the local hazardous material control officer for guidance since local codes may vary as it relates to locker location, ventilation and sprinkler system.

c. At a minimum, the following procedures will apply non-explosive training aids:

(1) Store in a locked, cool, dry, and ventilated hazmat locker (see paragraph 8b above).

(2) DO NOT store with explosive training aids.

(3) Store potassium chlorate training aids in a separate container than those used for the sodium chlorate [example-separate M19A1 ammo cans within the hazmat locker].

(4) It is preferred that AN be stored in a separate locker, but as an expedient, it can be stored in the same locker with chlorates in a separate sealed container [e.g., 5-gallon plastic buckets with snap lids] than those used for the other aids.

24 FEB 2020

(5) Protect against physical damage and moisture.

(6) Isolate from any source of heat or ignition.

(7) Avoid storage on wood floors.

(8) Separate from incompatible components such as combustibles, organic or other materials subject to rapid oxidation.

(9) A current copy of the MSDS for each oxidizer should be maintained within the hazmat locker for ready reference.

(10) Oxidizer storage containers may be hazardous when empty since they retain product residues (dust, solids). Observe all warnings and precautions listed for the product.

9. Disposition. Chlorates shall be handled as hazardous waste and should be sent to an approved waste facility on the disposal schedule of table N-2. MWD sections shall coordinate disposition with the installation and/or command environmental compliance and hazardous materials control agencies.

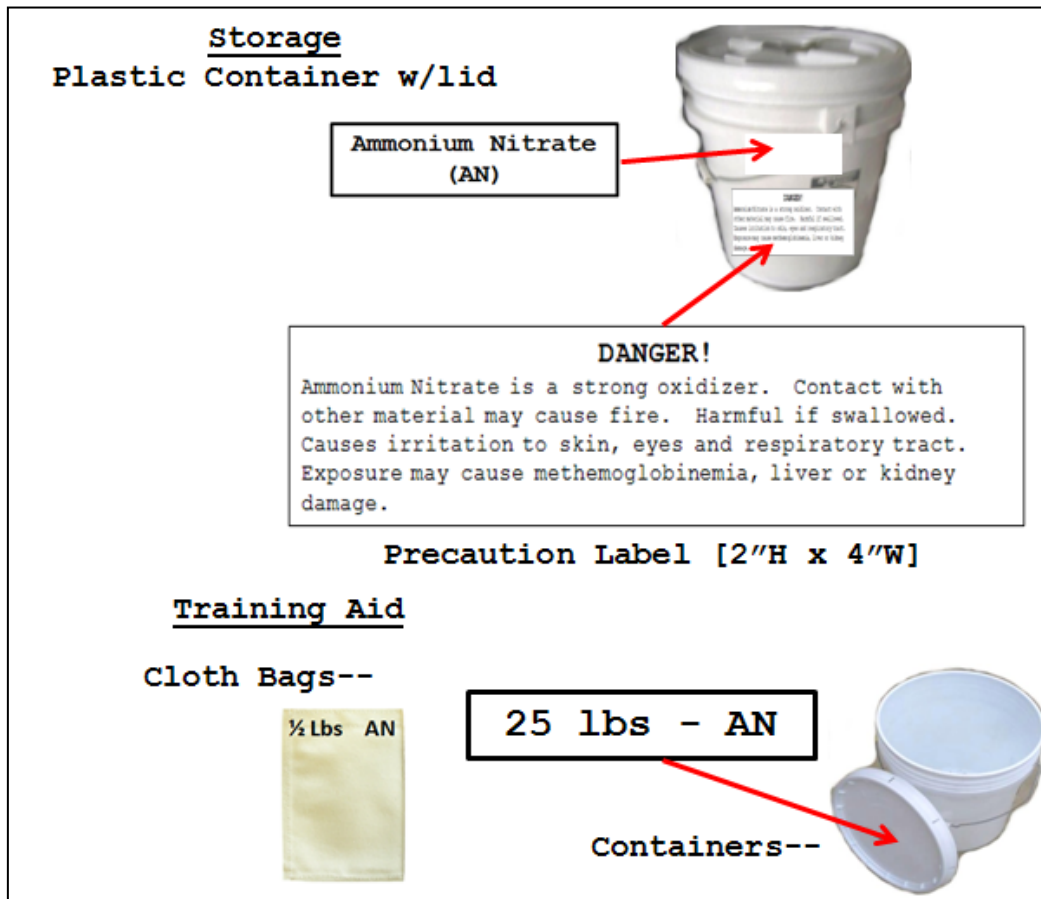

Figure N-1.--Nitrate Markings



Figure N-2.--Chlorate Markings

**APPENDIX O**

On-The-Job Training Guide

**Table of Contents**

<u>IDENTIFICATION</u>	<u>TITLE</u>	<u>PAGE</u>
<b>PARAGRAPHS</b>		
1	Purpose.....	O-1
2	Introduction.....	O-1
3	Scope.....	O-2
4	Planning OJT Handler Requirement.....	O-2
5	Candidate Screening Process..	O-3
6	Requesting Handler Course....	O-5
7	OJT Activities.....	O-5
8	Recording OJT Activity in WDMS.....	O-5
<b>FIGURES</b>		
O-1	Screening and Selection Phases.....	O-4
O-2	Attributes in Screening and Selection.....	O-4
<b>TABLES</b>		
O-1	Typical OJT Handler Timeline.	O-2
<b>TABS</b>		
O1	OJT Training Worksheet.....	O1-1

1. Purpose. This appendix provides a guide for the kennel master to establish an on-the-job training (OJT) program for the purpose of selecting and mentoring qualified candidates to obtain the military occupational specialty (MOS) 5812 [Military Police (MP) Handler] or 0083 [Civilian Police Handler].

2. Introduction. Chapter 3 (section 3106) provides the policy and procedures associated with the Marine Corps requirements for each MWD section to conduct an OJT program with the objective of filling MWD handler billets. Only volunteers from the MP community and recommended by their kennel master are selected to attend. Civilian police handlers are recruited in accordance with local human resources procedures, but the OJT process could be applicable for a GS civilian police officer desiring to transfer in to the MWD section.



24 FEB 2020

3. Scope. This guide is applicable for all MWD sections with either military and/or civilian police handler billets at their bases and LE Bns.

4. Planning OJT Handler Requirement. Planning the number of OJT handlers required at any one time is a factor of the number of the foreseeable and unexpected attrition of qualified handlers within the MWD section. Also, changes in the manpower authorization level will impact the requirement for the recruitment of OJT personnel, both military and civilian. Table O-1 provides an estimated timeline for a typical OJT process from candidate search to receipt of qualified handler on board. Due to the amount of time required to process a prospective handler, the kennel master must maintain accurate manpower projections based on the forecasted end-of-service dates, transfers, retirements, and terminations [possibly handler performance issues]. Candidates for the OJT program should have at least 18 months left on station at the beginning of the selection process.

<b>Table O-1.--Typical OJT Handler Timeline</b>		
<b>Activity</b>	<b>Est. Days</b>	<b>Remarks if Applicable</b>
<b>Solicitation for Candidates</b>	15	Working within the command, MPs are requested to submit a request to be considered for the OJT handler program.
<b>Selection Board</b>	15	The time required will depend on the schedule conflicts of the personnel required to sit on the board.
<b>Request for Handler Class</b>	10	
<b>Wait for Class Start</b>	60	School availability is dependent on - <ul style="list-style-type: none"> <li>• How many seats have been allocated to the Marine Corps.</li> <li>• Other service approval for Marine Corps to fill vacant seat.</li> </ul>
<b>OJT at MWD Section</b>		<ol style="list-style-type: none"> <li>1. Normally a minimum of 30 days is spent with the MWD section depending on the command ability to release the person.</li> <li>2. Suggest starting this period as early as possible to identify any change in the candidate's desire to become a handler.</li> </ol>
<b>Handler Course</b>	80	Both military and civilian police attend the same handler course [see table 3-2 for details] conducted at JBSA-Lackland, TX.
<b>Total Process Time</b>	180	Almost <u>six month</u> process.

**NOTE**

Military candidates for the Specialized Search Dog and Combat Tracker Dog handler courses are selected from handlers who hold the MOS 5812 and have completed the Basic Handler Course.

5. Candidate Screening Process. An important insight into the MWD handler screening process is presented in the 2015 study, "Military Working Dog Screening and Selection," sponsored by two USMC organizations: the MWD Program and the Technical Support Working Group (TSWG)\*. The study provides recommended tools to include instructions and forms that support the phases illustrated in figure O-1. This approach exposes candidates to several selection phases, or "hurdles," each of which must be cleared before an applicant progresses to the next step. The objective of the process is to accurately evaluate those most important pre-training candidate attributes identified in figure O-2.

**\* The study is available in the WDMS library and is a required hardcopy reference per Appendix F.**

a. SE PMO or LE Bn should select OJT handlers by a competitive board comprised primarily of MWD handlers with the KM acting as the senior member of the board and the other members appointed by the command.

b. As the board chairman, the KM will submit a report to the PM, PC, or LE Bn commanding officer with the recommended candidate(s) for the OJT program.

c. It is imperative that the KM review and fully understand the reference study identified above. Questions should be directed to the MWD PM.

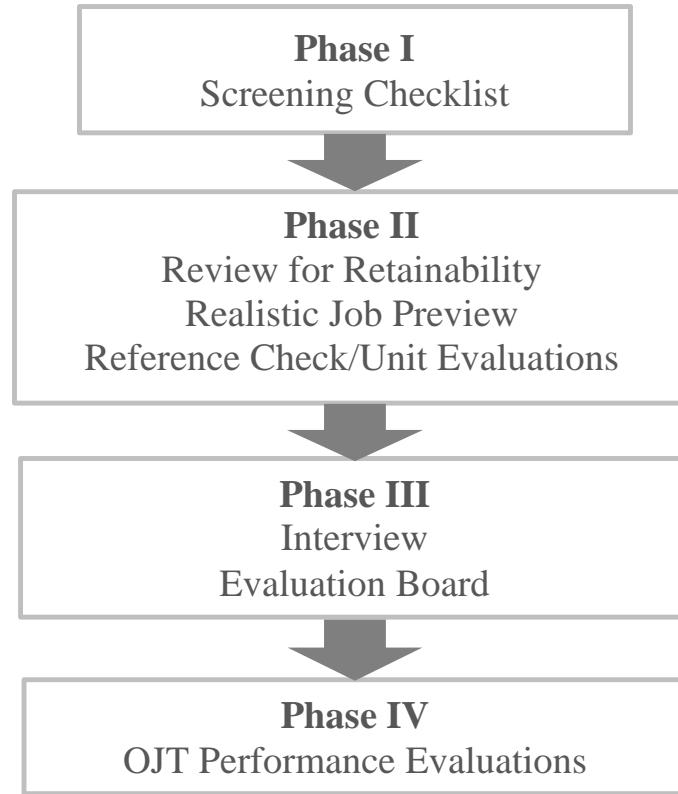

Figure O-1.—Screening and Selection Phases

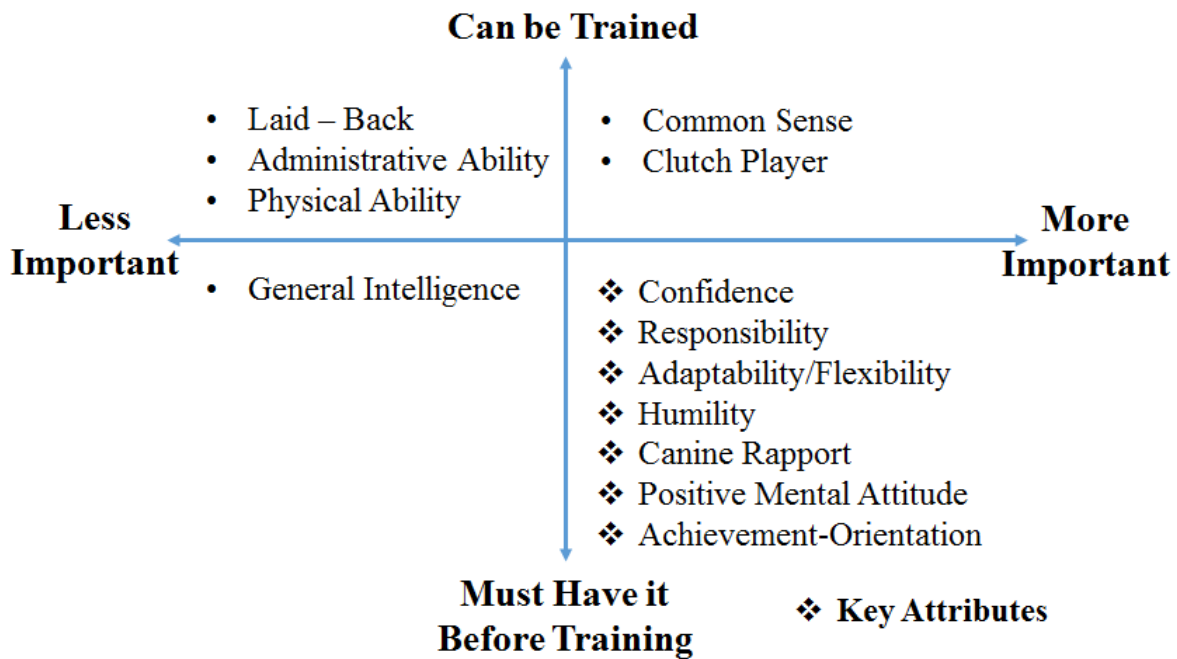

Figure O-2.—Attributes in Screening and Selection

24 FEB 2020

6. Requesting Handler Course. Once the command approves the OJT handler selection, the kennel master will request a handler course seat from HQMC Security Division. Requests for an OJT class seat should include candidate's full name, rank, DoD ID number (also called EDIPI and can be found on back of their CAC), and desired start date and submitted to the MWD PM [see Appendix C].

7. OJT Activities

**IMPORTANT**

OJT candidates are not authorized to handle an MWD in the course of performing MWD duties in an operational situation.

The selected OJT candidate should be assigned to the MWD section for the purposes of familiarization with basic MWD care and an introduction to the requirements of being an MWD handler. During this OJT time, the kennel master and trainer will observe the candidate with MWDs with the objective of observing potential character deficiencies that might result in a future issue in performing handler duties. The kennel master should ensure that the topics in the handler training worksheet of TAB O-1 are addressed, when possible, in advance of the candidate leaving for MWD handler course.

8. Recording OJT Activity in WDMS. Chapter 8 (paragraph 8104.2.e) describes how an individual on OJT can gain access to WDMS to record training activities with an MWD. The recording process can be a beneficial component of the OJT experience.

**TAB 01**

On-The-Job Training Worksheet

<b>On-The-Job Training Worksheet</b>			
<b>OJT Name (Last, First)</b>		<b>Rank</b>	<b>Start Date</b>
<b>Topic</b>	<b>Recommended Action</b> • (D)Discussion • (Demo)Demonstration	<b>Provided By/Date</b>	<b>Reference</b>
<b>KENNEL FACILITIES AND EQUIPMENT</b>			
Facility SOPs	D		
Non-MWDs in Kennel	D		Chapter 10
Facility Inspection for Harmful Materials	D/DEMO		Chapter 10
Safety procedures for:			Chapter 10
Horseplay	D		
MWD Loose	D		
Dog Fight	D		
Dog Bite	D		
Facilities / Equipment Upkeep	D		Chapter 9
Emergency Procedures / Evacuation Plan	D		Chapter 10
<b>MWD HEALTH CARE AND FEEDING</b>			
Parasites	D		Ref (y)
Grooming, bathing, and Health Check	D/DEMO		Chapter 10
Medication Administration	D		Ref (y)
First Aid / Emergency Medical Procedures	D		Ref (y)
Feeding Procedures	D/DEMO		Chapter 10
Special Diet	D		Chapter 10
Sanitizing Kennel	D/DEMO		Chapter 10

24 FEB 2020

<b>On-The-Job Training Worksheet</b>			
<b>OJT Name (Last, First)</b>		<b>Rank</b>	<b>Start Date</b>
<b>Topic</b>	<b>Recommended Action</b> • (D)Discussion • (Demo)Demonstration	<b>Provided By/Date</b>	<b>Reference</b>
Stool Report	D/DEMO		Appendix E
<b>BASIC SKILLS (All)</b>			
Basic Commands	D		Appendix D
Obstacle Course	D/DEMO		Appendix L
MWD Basic Senses	D		Chapter 4
Gunfire (Handler, Decoy)	D/DEMO		Appendix D
Conducting Demonstration	D		Appendix J
<b>PATROL MWD (PDDD/PEDD)</b>			
Duties And Responsibilities	D		Chapter 6
Decoy/Handler Safety	D/DEMO		Appendix D
Controlled Aggression Events	D/DEMO		Appendix D
Building Search	D/DEMO		Appendix D
Scouting	D/DEMO		Appendix D
Spotter Responsibilities	D		
Decoy w/MWD On-Leash	D/DEMO		Appendix D
Decoy w/MWD Off-Leash	D/DEMO		Appendix D
<b>DRUG MWD (DDD/PDDD)</b>			
Duties And Responsibilities	D		Chapter 6
Search Techniques/Pattern	D		Appendix D
Commands	D/DEMO		Appendix D

<b>On-The-Job Training Worksheet</b>			
<b>OJT Name (Last, First)</b>		<b>Rank</b>	<b>Start Date</b>
<b>Topic</b>	<b>Recommended Action</b> • (D)Discussion • (Demo)Demonstration	<b>Provided By/Date</b>	<b>Reference</b>
Training Aid Security / Safety / Procedures	D		Chapter 11
Site Preparation	D/DEMO		Appendix D
Training Aid Placement	D/DEMO		Appendix M
Detection Event Worksheet	D/DEMO		Appendix E
<b>EXPLOSIVE MWD (EDD/PEDD/SSD)</b>			
Duties And Responsibilities	D		Chapter 6
Search Techniques/Pattern	D		Appendix D
Commands	D/DEMO		Appendix D
Training Aid Security / Safety / Procedures	D		Chapter 12
Site Preparation	D		Chapter 6
Training Aids Placement	D/DEMO		Chapter 12
Electrical Storm Plan	D		Chapter 12
CEAP Inspection	D/DEMO		Appendix N
Detection Event Worksheet	D/DEMO		Appendix E
<b>TRACKER MWD (CTD)</b>			
Duties And Responsibilities	D		Chapter 6
Tracking Techniques/Patterns	D		Appendix D
Commands	D/DEMO		Appendix D
Decoy Responsibilities	D/DEMO		Appendix D

<b>On-The-Job Training Worksheet</b>			
<b>OJT Name (Last, First)</b>		<b>Rank</b>	<b>Start Date</b>
<b>Topic</b>	<b>Recommended Action</b> • (D)Discussion • (Demo)Demonstration	<b>Provided By/Date</b>	<b>Reference</b>
Tracking Event Worksheet	D/DEMO		Appendix E
<b>MWD TEAM TVC PROCESS</b>			
Training	D		Chapter 5
Validation	D		Chapter 5
Certification	D		Chapter 5
<b>ADMINISTRATION</b>			
WDMS Access	D		Chapter 8
MWD Activity Recording	D/DEMO		Chapter 8
Monthly Activity Report	D/DEMO		Appendix E
MWD Team Readiness	D		Chapter 5
MWD Section Operating Status	D		Chapter 8
MP Activity Reports	D/DEMO		
<b>SPECIAL HANDLER REQUIREMENTS</b>			
Legal Responsibilities	D		Chapter 6
Medical (Spleen / Shots)	D		Chapter 3
Government Motor Vehicle Operator's License W/Explosive Driver	D		Chapter 3
Passport	D		Chapter 3
Clothing Allowance	D		Chapter 3
Government Credit Card Responsibilities	D		Chapter 3
<b>ADDITIONAL TOPICS</b>			



<b>On-The-Job Training Worksheet</b>			
<b>OJT Name (Last, First)</b>		<b>Rank</b>	<b>Start Date</b>
<b>Topic</b>	<b>Recommended Action</b> <ul style="list-style-type: none"><li>• (D)Discussion</li><li>• (Demo)Demonstration</li></ul>	<b>Provided By/Date</b>	<b>Reference</b>
<b>NOTES</b>			

**APPENDIX P**

Military Working Dog (MWD) Trailer Maintenance Guide

**Table of Contents**





<u>IDENTIFICATION</u>	<u>TITLE</u>	<u>PAGE</u>
<b>PARAGRAPH</b>		
1	Purpose.....	P-1
2	Introduction.....	P-1
3	Scope.....	P-1
4	Trailer Inspection.....	P-1
<b>TABLES</b>		
P-1	MWD Transport Trailer Types	P-2
<b>TABS</b>		
P1	MWD Transport Trailer Inspection Sheet.....	P1-1

1. Purpose. This appendix provides a guide for the kennel master to ensure maintenance is properly conducted on the Military Working Dog (MWD) transport trailers.

2. Introduction. Each MWD section currently has commercial MWD transport trailers. These assets play an important role in the transport of MWDs to on-base locations for training and during the conduct of MP support operations. Also, during the time of natural disaster or a kennel facility fire, the use of trailers is critical in moving all MWDs out of the area of danger. Each trailer must be maintained in operational condition if it is to be reliable in the performance of safely transporting MWDs. The kennel master is responsible to ensure the operator maintenance is conducted on schedule and repairs conducted in accordance with this guide.

3. Scope. This guide is generally applicable to all MWD transport trailers currently in Marine Corps inventory as shown in table P-1.

4. Trailer Inspection. Use Tab-P1 to conduct regular inspections of the MWD transport trailer. Corrective maintenance should be completed as soon as possible after the discrepancy is identified or when the regularly required maintenance service work is required.

<b>Table P-1.--MWD Transport Trailer Types</b>		
<b>Type</b>	<b>Example Image</b>	<b>Manufacturer Info</b>
<b>6 Stalls</b>		<ul style="list-style-type: none"> <li>• Trakker Trailer</li> <li>• Out of business since 2007 (see note)</li> </ul>
<b>8 Stalls</b>		<ul style="list-style-type: none"> <li>• Trakker Trailer</li> <li>• Out of business since 2007 (see note)</li> </ul>
<b>8 Stalls</b>		<ul style="list-style-type: none"> <li>• Jones Trailer 201 U.S. 183 Woodson, TX 76491</li> <li>• (940) 345-6759</li> </ul>
<b>MWD Kennel Truck - 6 Stall</b>		<ul style="list-style-type: none"> <li>• Troy Industries Redford, MI</li> <li>• (313) 592-2386</li> </ul>
<p><b>NOTE:</b> Recommend contacting a local trailer/RV service repair center for servicing the Trakker trailers since some bases have been successful taking this approach when the base Motor Pool cannot service the trailer.</p>		

TAB P1

Military Working Dog (MWD) Transport Trailer Inspection Sheet

NAME OF EQUIPMENT: **MWD Trailer** No. Stalls:  Serial No.:

Organization:

INSPECTION TASK (2)	Cycle (1)	MONTH [ 20__ __ ]												REMARKS
		J	F	M	A	M	J	J	A	S	O	N	D	

**Trailer Exterior & Kennel Stalls**

Inspect with particular attention to <b>damaged areas and sharp edges</b> that may injure the MWD	<b>M</b>													
Inspect/repair/replace loose rivets/molding on exterior of trailer	<b>M</b>													
Inspect/repair loose panels inside dog stalls	<b>M</b>													
Inspect/repair/replace loose door latches and door hinges	<b>M</b>													
Inspect/repair/replace vents, vent rings and vent trim.	<b>M</b>													
Inspect/repair/replace lights	<b>M</b>													
Inspect/repair/replace exhaust fans	<b>M</b>													
Inspect/repair/replace wiring to include trailer break-away kits	<b>M</b>													
Inspect/repair/replace exhaust system	<b>M</b>													

**Air Conditioning**

Perform amp test on AC unit	<b>A</b>													
Clean evaporator and condenser on AC Units	<b>M</b>													
Perform load test at partial load and full load	<b>A</b>													
Inspect/add Freon as necessary	<b>A</b>													
Inspect/clean/replace filters and remount inside ceiling assembly	<b>M</b>													
Inspect/Replace any other AC parts	<b>A</b>													

24 FEB 2020

NAME OF EQUIPMENT: <b>MWD Trailer</b> No. Stalls: <input type="text"/>		Serial No.: <input type="text"/>												
Organization: <input type="text"/>														
INSPECTION TASK (2)	Cycle (1)	MONTH [ 20__ __ ]												REMARKS
		J	F	M	A	M	J	J	A	S	O	N	D	
<b>Generator</b>														
Perform general maintenance on generator per service manual	<b>A</b>													
<b>April-May</b> General Service														
• Install complete maintenance kits (3)	<b>A</b>													
• Test voltage	<b>A</b>													
• Reset cycles on generator	<b>A</b>													
• Check hour meter to ensure unit is working	<b>A</b>													
<b>Battery and Charging</b>														
Test voltage plugs on trailer to ensure units are working properly and not overheating GFI sockets	<b>M</b>													
Test battery and load test	<b>M</b>													
Test battery charger if trailer is equipped with one	<b>M</b>													
<b>Wheel Bearings</b>														
Repack bearings	<b>A</b>													
<p>(1) Cycle key: <b>A</b> = Annual, <b>M</b> = Monthly</p> <p>(2) Use only Original Equipment Manufacturer Parts. Kits and service manuals can be ordered through So-Tex Engine and Generator Company 210-661-8193 or your local auto supply company.</p> <p>(3) <b>Generac Generator Maintenance Kit</b>. Model #s 0020102 and 0047060 [Kit includes: Spark plug, oil filter and air filter]</p>														

**APPENDIX Q**

Clothing Guide For Non-Operational Missions

**Table of Contents**

<u>IDENTIFICATION</u>	<u>TITLE</u>	<u>PAGE</u>
<b>PARAGRAPH</b>		
1	Purpose.....	Q-1
2	Introduction.....	Q-1
3	Civilian Attire.....	Q-1
4	Clothing Selection.....	Q-1
<b>FIGURES</b>		
Q-1	Example Male / Female Handler Civilian Attire.....	Q-2
<b>TABLES</b>		
Q-1	Civilian Clothing Checklist	Q-2

1. Purpose. This appendix provides a guide for the type of clothing that Marine Corps MWD handlers will have to obtain for employment on non-operational missions.

2. Introduction. Chapter 6 provides the policy and procedures associated with MWD handlers, both military and civilian, being assigned to support non-operational missions. It has been directed only civilian attire is appropriate for this type of support unless otherwise directed in the tasking message. As defined in Chapter 3 (section 3200), selected military MWD handlers are authorized to obtain a one-time special clothing allowance to cover the cost of purchasing civilian clothing needed for non-operational commitments.

3. Civilian Attire. Figure Q-1 provides examples of the proper civilian attire for non-operational missions. The tasking message will specify which attire is appropriate for the working environment. Handlers should not wear civilian clothing with any military or organizational insignia on these missions.

4. Clothing Selection. Table Q-1 lists those types of civilian clothing that a handler should have in serviceable condition.

**IMPORTANT**

Table Q-1 represents requirement for male handlers. Female handlers shall need the equivalent style - **SLACKS ONLY** [NO SKIRTS].

Table Q-1.--Civilian Clothing Checklist (Minimum Requirement)	
Quantity	Item
2	Dark business suit <u>or</u> Blazer jacket w/trouser sets
2	Shirt, White
2	Tie, Conservative
1	Shoes, Dress, Dark
2	Shirt, Polo, Dark
2	Trousers, Casual, Khaki (Plain or Cargo)

**MALE**



**Suit**



**Blazer**



**w/Cargo  
Trousers**



**w/Plain  
Trousers**

**Polo Shirt**

**FEMALE**



**w/  
Plain Slacks**

Figure Q-1: Example Male/Female Handler Civilian Attire