

# **Imagery Intelligence**

---



**US Marine Corps**

---

DISTRIBUTION STATEMENT A: Approved for public release; distribution is unlimited.

**PCN 144 000243 00**

CD&I (C 116)

2 May 2016

ERRATUM

to

MCWP 2-21

IMAGERY INTELLIGENCE

1. Change all instances of MCWP 2-21, *Imagery Intelligence*, to MCRP 2-10B.5, *Imagery Intelligence*.
2. Change PCN 143 000088 00 to PCN 144 000243 00
3. File this transmittal sheet in the front of this publication.

PCN 144 000243 80

DEPARTMENT OF THE NAVY  
HEADQUARTERS UNITED STATES MARINE CORPS  
WASHINGTON, D.C. 20350-3000

29 February 2016

FOREWORD

Marine Corps Doctrinal Publication 2, *Intelligence*, and Marine Corps Warfighting Publication (MCWP) 2-1, *Intelligence Operations*, describe the doctrine and higher order tactics, techniques, and procedures employed in intelligence operations. Marine Corps Warfighting Publication 2-21, *Imagery Intelligence*, complements these publications by detailing the specific doctrine and tactics, techniques, and procedures for producing and collecting imagery intelligence (IMINT) in support of Marine Corps operational requirements.

The primary target audience of this publication is intelligence personnel responsible for the planning and execution of IMINT operations. Personnel who provide support to intelligence requirements through imagery operations, or personnel who utilize imagery intelligence, will also benefit from studying this publication.

Marine Corps Warfighting Publication 2-21 describes all aspects of IMINT, including basic doctrine, command and control relationships, communications and information systems, planning and execution, equipment, security, and training. It provides the fundamental information Marines need to understand, plan, and execute IMINT operations in support of the operating forces.

This publication supersedes MCWP 2-21, *Imagery Intelligence*, dated 6 September 2002, (formerly MCWP 2-15.4, modified to current short title by erratum dated 13 July 2004).

Reviewed and approved this date.

BY DIRECTION OF THE COMMANDANT OF THE MARINE CORPS



ROBERT S. WALSH  
Lieutenant General, U.S. Marine Corps  
Deputy Commandant for Combat Development and Integration

Publication Control Number: 143 000088 00

DISTRIBUTION STATEMENT A: Approved for public release; distribution is unlimited.

## Table of Contents

---

### Chapter 1. Fundamentals

Introduction to Geospatial Intelligence .....	1-1
Elements of Geospatial Intelligence.....	1-1
Components of Geospatial Intelligence .....	1-2
Marine Corps Geospatial Intelligence Enterprise.....	1-3
Mission.....	1-3
Purpose.....	1-3
Method .....	1-3
Imagery Versus Imagery Intelligence.....	1-3
Objectives of Imagery Intelligence.....	1-4
Capabilities and Limitations of Imagery Intelligence .....	1-4
Capabilities.....	1-4
Limitations .....	1-4
Responsibilities and Products .....	1-4
Marine Corps Imagery Intelligence Responsibilities.....	1-5
Types of Imagery Intelligence Products .....	1-6
Role and Functions .....	1-6
Tactical Imagery Intelligence Principles .....	1-7
Focus on Tactical Intelligence .....	1-7
Centralized Management .....	1-7
G-2/S-2 Facilitation.....	1-7
Tailored and Timely Intelligence .....	1-7
Intelligence and Imagery Intelligence Cycles.....	1-8
General .....	1-8
Tasking, Collection, Processing, Exploitation, and Dissemination Process .....	1-8
Imagery-Derived Products .....	1-10
G-2/S-2 Role in the Intelligence Cycle .....	1-11
Levels of Imagery Intelligence .....	1-12
National Imagery Intelligence.....	1-13
Tactical Imagery Intelligence .....	1-13
Theater Imagery Intelligence .....	1-15

---

### Chapter 2. Organizations and Responsibilities

Marine Expeditionary Force Key Personnel Responsibilities .....	2-1
Role of the Commander .....	2-1
Marine Expeditionary Force Command Element: G-2 Section and the Intelligence Battalion.....	2-2
Marine Expeditionary Force Command Element: Other Staff Sections.....	2-9
Intelligence Officers at Marine Expeditionary Force Major Subordinate Commands .....	2-10

National Imagery Organizations.....	2-10
Office of the Director of National Intelligence.....	2-10
National Geospatial-Intelligence Agency.....	2-11
National Intelligence Support Team.....	2-12
National Reconnaissance Office.....	2-15
Defense Intelligence Agency.....	2-15
Marine Corps Supporting Establishment Imagery Intelligence Organizations.....	2-15
Headquarters, United States Marine Corps.....	2-15
Deputy Commandant for Combat Development and Integration.....	2-16
Marine Corps Systems Command.....	2-16
Marine Corps Intelligence Activity.....	2-17
National Geospatial-Intelligence Agency Support Teams.....	2-17

---

### Chapter 3. MAGTF Imagery Intelligence Units and Organizations

Imagery Intelligence Platoon Intelligence Battalion.....	3-1
Mission and Tasks.....	3-1
Organization.....	3-1
Command and Control.....	3-2
Concept of Employment.....	3-3
Miscellaneous.....	3-3
Tactical Analysis and Combat Tracking Exploitation Team, Intelligence Battalion.....	3-5
Mission and Tasks.....	3-5
Organization.....	3-6
Command and Control.....	3-6
Concept of Employment.....	3-6
Miscellaneous.....	3-7
Marine Unmanned Aerial Vehicle Squadron.....	3-8
Mission and Tasks.....	3-8
Organization.....	3-8
Command and Control.....	3-8
Concept of Employment.....	3-9
Miscellaneous.....	3-9
Marine Fighter/Attack (All-Weather) Squadron.....	3-10
Mission and Tasks.....	3-10
Organization.....	3-10
Command and Control.....	3-11
Concept of Employment.....	3-11
Miscellaneous.....	3-11
Ground Reconnaissance.....	3-12
Mission.....	3-12
Organization.....	3-12
Command and Control.....	3-13
Concept of Employment.....	3-13

---

## Chapter 4. Imagery Intelligence Systems, C2 Nodes, CIS, and Other Systems

Basic Imagery Intelligence Communications and Information Systems Requirements .....	4-1
Managing Subordinate Imagery Intelligence Units .....	4-1
Receiving Data and Information From Organic/External Imagery Intelligence Organizations .....	4-1
Providing Intelligence to Supported Commanders .....	4-1
Providing Imagery Intelligence Products and Reports to National Intelligence Centers, Theater, Joint Task Force, MAGTF, and Other Components .....	4-1
Imagery Intelligence and Related Command and Control Nodes .....	4-2
Combatant Commander Joint Intelligence Operation Center .....	4-2
Joint Task Force J-2 and the Joint Intelligence Support Element .....	4-2
Marine Expeditionary Force Command Element .....	4-3
Imagery Intelligence Information Systems and Supporting Communications .....	4-7
Imagery Direction and Collection Management .....	4-7
Geospatial Intelligence Information Management Services .....	4-9
Imagery Collection .....	4-9
Imagery Tasking, Processing, Exploitation, and Dissemination Capabilities .....	4-16
Imagery Communications and Information Systems Architecture .....	4-17
Geospatial Intelligence Communications and Information Systems Planning Considerations .....	4-17

---

## Chapter 5. Planning

Support to the Planning Process .....	5-1
Planning for Imagery Intelligence .....	5-1
Types of Imagery .....	5-9
Aerial Imagery Collection Missions .....	5-12
Processing, Exploitation, and Dissemination of Imagery and Imagery Intelligence .....	5-14

---

## Chapter 6. Training

Imagery Training .....	6-1
Requirements .....	6-1
Training Objectives .....	6-1
Planning and Employment Training .....	6-2
MAGTF Training .....	6-2
Training Courses .....	6-3
Basic-Level: Tactical Imagery Analysis Course .....	6-3
Intermediate- and Advanced-Level Training .....	6-4
Follow-On Training Subject Areas .....	6-5

---

## Appendices

A	Imaging Sensors .....	A-1
B	Imagery and Supporting Intelligence Reports .....	B-1
C	Imagery Intelligence Support to Intelligence Studies.....	C-1
D	National Imagery Interpretability Rating Scale.....	D-1
E	Video National Imagery Interpretability Rating Scale .....	E-1
F	Imagery Intelligence Report Formats .....	F-1
G	Example of a Marine Unmanned Aerial Vehicle Squadron Equipment and Performance Characteristics .....	G-1
H	Request Formats for Aerial Imagery Collection Missions .....	H-1
I	Target Folders.....	I-1
J	National Imagery Transmission Format Compression.....	J-1
K	Imagery Intelligence Appendix Format.....	K-1
L	Unmanned Aircraft System Formats .....	L-1
M	Aerial Imagery Plan Format .....	M-1

## Glossary

## References and Related Publications

## To Our Reader

---

# CHAPTER 1

## FUNDAMENTALS

---

### INTRODUCTION TO GEOSPATIAL INTELLIGENCE

Geospatial intelligence (GEOINT) was originally formed by integrating imagery, imagery intelligence (IMINT), and geospatial information. The meteorological and oceanographic (METOC) capability was added to the discipline in 2006. Advances in technology, along with the development of geospatial data standards, have created an environment in which the elements of GEOINT can be combined with one another as well as with other information sources. This fusion of resources has provided the means for conducting complex analysis and creating new specialized products.

#### **Elements of Geospatial Intelligence**

Geospatial intelligence is composed of four elements: imagery, IMINT, geospatial information, and METOC information.

**Imagery.** Imagery is a likeness or presentation of any natural or manmade feature or related object or activity and the positional data acquired at the same time the likeness or representation was acquired, including products produced by space-based national intelligence reconnaissance systems and likenesses or presentations produced by satellites, airborne platforms, unmanned aircraft systems (UASs), or other similar means.

**Imagery Intelligence.** Imagery intelligence is derived from the exploitation of collected images—by visual photography, infrared sensors, lasers, electro-optics, and radar sensors such as synthetic aperture radar (SAR)—wherein the images are reproduced optically or electronically on film, electronic display devices, or other media.

**Geospatial Information.** Geospatial information identifies the geographic location and characteristics of natural or constructed features and boundaries on the Earth. Geospatial information includes statistical data and information derived from remote sensing, mapping, and surveying technologies as well as mapping, charting, geodetic data and related products.

**Meteorological and Oceanographic.** Collectors of METOC information assess and characterize the current and future conditions, phenomena, and associated effects influencing the operational area's physical environment and integrate these time-sensitive essential elements of information (EEIs) into the continuous Marine Corps Planning Process (MCP) to mitigate adverse conditions/exploit conditions of opportunity.



## Components of Geospatial Intelligence

The components of GEOINT are the GEOINT discipline, GEOINT data, and GEOINT products and services.

***The Geospatial Intelligence Discipline.*** Geospatial intelligence encompasses all of the activities related to the planning, collection, processing, analysis, exploitation, and dissemination of spatial information in order to gain intelligence about the national security or operational environment, depict this knowledge visually, and fuse the acquired knowledge with other information through analysis and visualization processes.

***Geospatial Intelligence Data.*** Geospatial data refers to any data used to create GEOINT products. This data can be derived from either a single source or from multiple classified or unclassified sources. Analysts within the GEOINT discipline also incorporate data from other intelligence disciplines, such as human intelligence (HUMINT) or signals intelligence (SIGINT), to create fused all-source intelligence products.

***Geospatial Intelligence Products and Services.*** Geospatial intelligence products range from standard geospatial data-derived products to specialized products that incorporate data from multiple sensors.

*Standard Products.* These data-derived products (i.e., maps, charts, imagery and digital information to support visualization activities such as a common operational picture [COP]) may be used alone or with multiple layers of data (e.g., vegetation, culture, languages, and weather) and intelligence information. Standard products are derived primarily from electro-optical (EO) sensors and existing geospatial data.

*Specialized Products.* Each specialized product is tailored for a particular purpose. The products may be developed using advanced technology to integrate multiple types of geospatial data as well as data from other intelligence sources; they may even incorporate the fourth dimension—time. These features enable analysts to create more comprehensive GEOINT products (e.g., two-color multiview, change detection, multi/hyper-spectral, line-of-sight products; environmental intelligence products; and fly-through studies).

*Geospatial Intelligence Services.* Geospatial intelligence services include all of the tools that enable users to access and manipulate data, such as the following:

- Geodetic surveys.
- Software development.
- Products and services tailored to support weapon systems.
- Calculation of precise locations for targeting of precision munitions.
- Training.
- On-site technical support.

---

## MARINE CORPS GEOSPATIAL INTELLIGENCE ENTERPRISE

The Marine Corps GEOINT Enterprise is the geospatial component of the Marine Corps Intelligence, Surveillance, and Reconnaissance-Enterprise (MCISR-E) providing geospatial information and services (GI&S) to meet Marine Corps requirements.

### **Mission**

The Marine Corps GEOINT Enterprise provides timely, relevant, and accurate GEOINT for planning, decisionmaking, and action in support of Marine Corps, joint, and combined operations.

### **Purpose**

The Marine Corps GEOINT Enterprise integrates GEOINT systems, sensors, processes, and organizations into the distributed common ground/surface system-Marine Corps (DCGS-MC) and the larger MCISR-E architecture in order to provide a horizontally and vertically integrated GEOINT Enterprise that is capable of supporting all Marine Corps operational objectives.

### **Method**

The Marine Corps adheres to established data standards to facilitate data sharing across the enterprise. This compliance enables end users to manipulate existing data for their particular mission requirements rather than recollecting data from previously serviced targets.

---

## IMAGERY VERSUS IMAGERY INTELLIGENCE

Imagery and IMINT are not the same thing. Imagery is a likeness or representation containing embedded positional data; it has not yet been analyzed or evaluated against other intelligence. Imagery intelligence, on the other hand, is the function performed by the G-2/S-2 that involves imagery analysis and integration with other intelligence-related activities to produce all-source intelligence products. Imagery interpretation personnel conduct planning and perform tasking, collection, processing, exploitation, and dissemination (TCPED) of intelligence to the commander. Properly trained personnel, adequate time, and sophisticated equipment are needed to produce and provide IMINT. Raw imagery may be disseminated to tactical commanders in support of operations; however, caution must be exercised to ensure those commanders are aware of the potential for misleading information when intelligence is based on a single, unevaluated source. Imagery intelligence aids commanders and planners in the following two ways:

- It provides situational awareness of the natural, manmade, and cultural terrain in support of the intelligence preparation of the battlespace (IPB).
- It is a source for confirming the analysis produced by other intelligence disciplines.

---

## OBJECTIVES OF IMAGERY INTELLIGENCE

The objectives of imagery intelligence are to increase the situational awareness of the commander and provide counterintelligence and force protection support. Imagery intelligence supports the commander's decisionmaking process by reducing uncertainty about the situation and the surrounding environment. It supports the identification of hostile intelligence collection operations, aids with the identification of Marine air-ground task force (MAGTF) vulnerabilities that could be exploited by the enemy, and assists with the evaluation of friendly security measures to counter these vulnerabilities.

---

## CAPABILITIES AND LIMITATIONS OF IMAGERY INTELLIGENCE

Imagery intelligence has discipline-specific capabilities and limitations.

### Capabilities

Imagery intelligence provides detailed and precise information regarding the location and the physical characteristics of the threat and the environment in which it is operating. It is the primary source of information concerning key terrain features, installations, and infrastructure used to build detailed intelligence studies, reports, and target materials. Order of battle (OOB) analysis, enemy course of action (COA) assessments, target intelligence development, and battle damage assessment (BDA) are intelligence functions that rely heavily upon IMINT.

### Limitations

The two types of limitations for imagery intelligence are general limitations and sensor limitations.

**General Limitations.** The general limitations to IMINT are tied to the availability of resources, such as collection platforms, exploitation systems, high capacity communications, skilled personnel, and the time available to complete the TCPED cycle. The intelligence shortfalls associated with these general limitations are compounded by weather effects; enemy air defense capabilities; and enemy camouflage, concealment, and deception (CCD) activities.

**Sensor Limitations.** See appendix A for information on sensor limitations. It describes the basic capabilities and limitations of EO, radar, and infrared imagery sensors.

---

## RESPONSIBILITIES AND PRODUCTS

The Marine Corps relies on a combination of national, theater, and organic IMINT sources to support both intelligence planning and intelligence operations. The employment of organic MAGTF intelligence collection assets within the assigned area of operations (AO) is not feasible until just prior to the introduction of forces due to the nature of expeditionary operations.

Consequently, national and/or theater intelligence assets should be exploited for IMINT support prior to entering the AO.

The MAGTF leverages external support during the planning and deployment phases of any operation. Even when employed, the MAGTF will continue to require national and theater support in specific areas to add depth and breadth to the reconnaissance effort and cover gaps in organic collection capabilities.

### **Marine Corps Imagery Intelligence Responsibilities**

Imagery intelligence responsibilities differ depending on the type and echelon of the unit.

**MAGTF G-2/S-2.** The MAGTF assistant chief of staff (AC/S) for intelligence (G-2/S-2) has staff responsibility for intelligence, surveillance, and reconnaissance (ISR)—including support of IMINT operations. In conjunction with the AC/S for operations (G-3/S-3), the G-2/S-2 develops the intelligence operations plan (appendix 16 to annex B), the supporting IMINT plan (appendix 7 to annex B), and the reconnaissance and surveillance plan (appendix 14 to annex B), which allocate resources and assign specific imagery reconnaissance and supporting missions to the MAGTF and supporting elements. Factors affecting the development of intelligence and supporting IMINT plans are as follows:

- Priority intelligence requirements (PIRs).
- Commander's critical information requirements (CCIRs).
- Communications connectivity and information systems.
- Time available.
- Available information and intelligence from other sources.
- Redundancy.
- Assets available.
- Enemy situation.
- Enemy counterreconnaissance capabilities.

The MAGTF G-2/S-2 develops specific intelligence, reconnaissance, and imagery-related tasks based on the commander's intent, anticipated enemy activity, the MAGTF concept of operations (CONOPS), and the overall intelligence operations plan. Individual units are assigned reconnaissance tasks per the intelligence plan. The intelligence support coordinator (ISC), under the staff cognizance of the MAGTF G-2/S-2, establishes an intelligence operations center (IOC).

**The Intelligence Operations Center.** The IOC is established by the MAGTF G-2/S-2 to perform intelligence requirements management; staff cognizance of ongoing organic and supporting collection operations; and intelligence production, analysis, and dissemination. Key elements of the IOC follow:

- *Support cell.* The support cell is the primary element for conducting Marine expeditionary force (MEF)-wide intelligence requirements management, METOC support, collections and dissemination planning and direction, and intelligence staff cognizance of MEF organic and supporting intelligence and reconnaissance operations.

- *Surveillance and reconnaissance center.* The surveillance and reconnaissance center (SARC) is the primary element that supervises the execution of organic and supporting intelligence and reconnaissance plans.
- *Production and analysis cell.* The primary production and analysis (P&A) element of the MAGTF is the P&A cell. It processes and produces all-source intelligence products in response to requirements of the MAGTF. Additionally, it is the principal IMINT/GEOINT production element of the MEF.

**Imagery Intelligence Units in the MAGTF.** The MAGTF subordinate units conduct intelligence and reconnaissance planning and operations in support of their own efforts through a variety of means. Close coordination with the ISC and IOC is essential to ensure overall effective MAGTF intelligence operations and intelligence support to all commanders.

Imagery intelligence and imagery-related data and information are collected by a variety of assets, each with unique capabilities and limitations. The following MAGTF units and organizations are likely to be tasked with imagery-related collection missions and production support:

- Intelligence battalions.
- Marine aircraft wings (MAWs): Marine unmanned aerial vehicle squadrons (VMUs), Marine fighter/attack (all weather) squadrons (VMFA[AW]s).
- Force/division reconnaissance units.

### **Types of Imagery Intelligence Products**

Imagery intelligence products include reports, mosaics, overlays, annotated images, and fused intelligence products. For a detailed discussion of imagery and IMINT products, see chapter 5. Appendix B provides examples of imagery products, while appendix C provides details on developing these products.

---

## **ROLE AND FUNCTIONS**

Imagery intelligence provides MAGTF commanders operational and tactical intelligence support. Imagery and IMINT support the following intelligence functions:

- Support to the commander's estimate.
- Situation development.
- Indications and warning (I&W).
- Force protection.
- Targeting.
- Combat assessment.

---

## TACTICAL IMAGERY INTELLIGENCE PRINCIPLES

The principles of tactical imagery intelligence are a focus on tactical intelligence; centralized management; G-2/S-2 facilitation; and a tailored, timely intelligence support.

### Focus on Tactical Intelligence

National and theater imagery assets support operations by all echelons of the MAGTF. The MAGTF IMINT operations combine the generation of tactical intelligence and utilization of strategic/operational IMINT for tactical purposes. Consideration should always be given to TCPED of products in support of MAGTF operations.

While the management of IMINT collection and production is centralized in the MAGTF command element, the overall focus is to support the planning and executing of missions by every element involved in the operation. Critical products are disseminated to tactical commanders, who will be able to request additional IMINT support as required.

### Centralized Management

Centralized collection and production management is essential due to the scarcity of IMINT assets, the broad dispersion of supported units, the limitations of range and capability, and the need to focus IMINT resources on the commander's PIRs. This centralizing of effort will be accomplished in the MAGTF IOC under the direction of the intelligence battalion commander functioning as the ISC. The MAGTF commander may attach or place task-organized IMINT elements in direct support of MAGTF subordinate elements.

### G-2/S-2 Facilitation

The MAGTF intelligence officer enables effective use of IMINT and other intelligence and reconnaissance activities and products throughout the unit. The MAGTF intelligence officer has three key subordinate officers:

- Intelligence operations officer, who is responsible for managing the information flow between the battle staff and the commander, current and future operations sections, and force fires.
- Intelligence plans officer, who is responsible for supporting the future plans team.
- Intelligence battalion commander, who, as the AC/S G-2's ISC, has principal staff responsibility for both disseminating intelligence throughout the MAGTF and ensuring that intelligence is understood. He must also facilitate responses to any new CCIRs that may result.

### Tailored and Timely Intelligence

The guiding principle that underpins all intelligence dissemination activities is to disseminate time sensitive intelligence products to the right people at the right time.

## INTELLIGENCE AND IMAGERY INTELLIGENCE CYCLES

The intelligence and imagery intelligence cycle are processes that the Marine Corps uses to develop and utilize intelligence.

### General

Intelligence is the output of a process that converts data and information into knowledge that impacts military decisions. The process used to develop intelligence is called the intelligence cycle (see fig. 1-1).

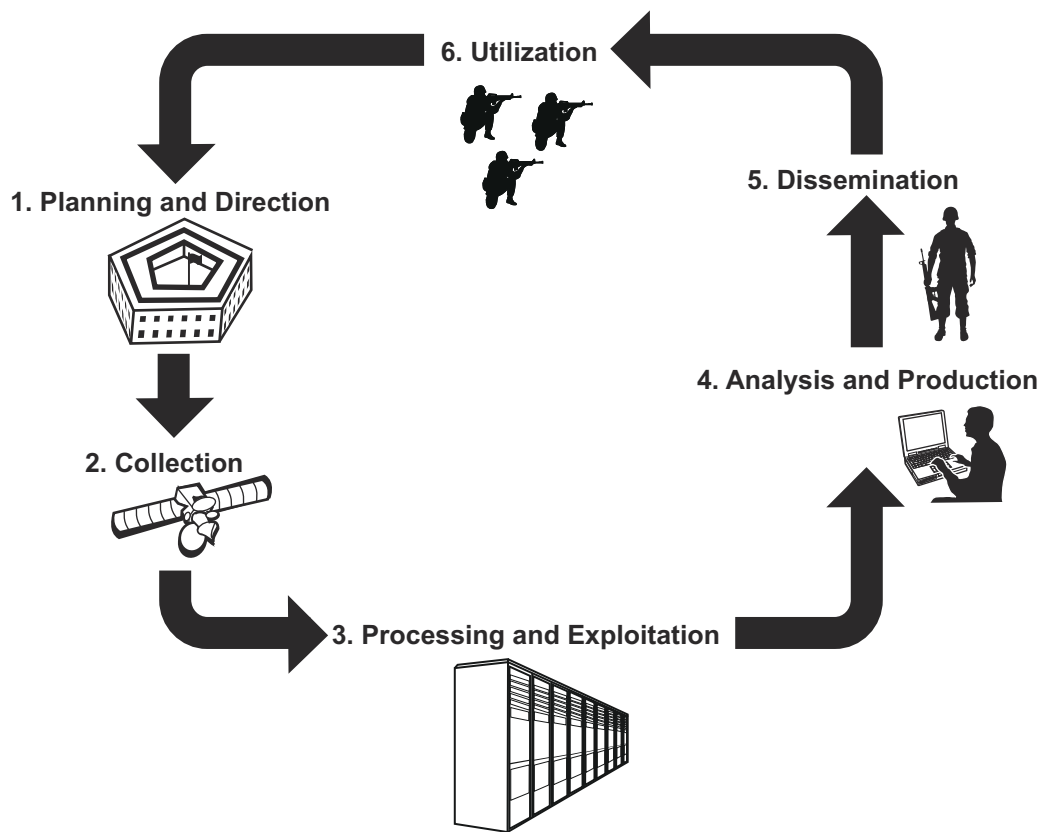

**Figure 1-1. United States Marine Corps Intelligence Cycle.**

The IMINT cycle mirrors the intelligence cycle. The steps in this cycle define a sequential, interdependent process for developing IMINT. Chapter 5 provides greater details on these cycles.

*Note:* The steps in the Marine Corps intelligence cycle differ from those that constitute the joint intelligence cycle, which de-emphasizes the utilization step of the cycle in favor of continuous evaluation and feedback.

### Tasking, Collection, Processing, Exploitation, and Dissemination Process

The TCPED process supports the flow of the intelligence cycle. It begins with the commander's request for information and ends with delivery of IMINT to the end-user. The success of the

TCPED process is tied to the decisionmaking cycle of that end-user (i.e., did the end-user get the IMINT needed to affect the commander's decision).

**Tasking.** Tasking is the process by which collection assets are assigned to collect against the commander's requirements. Additionally, it implies management of the entire TCPED process. Each user of imagery/GEOINT products will have distributed, seamless, and real-time access to existing databases located at each echelon of command. This access will show the user the coverage and types of information available. If no existing resources cover the requirement, then the user can request new imagery/imagery products (i.e., geospatial source information or a combination of products).

**Collection.** Collection managers (CMs) create, review, approve, and track imagery collection requirements. Imagery analysts determine whether or not imagery collection requirements have been satisfied and report user satisfaction to the CM.

**Processing.** Processing involves the conversion of collected data into information that is suitable for the production of intelligence. Processing is accomplished during collection and/or production. Some types of imagery data require minimal processing: they may be collected in a form that is already suitable for production. Other types of imagery data require extensive processing to incorporate amplifying data not available on the raw image products, which affects the timeliness and accuracy of the resulting information.

**Exploitation.** Exploitation is the extraction, analysis, and compilation of information from collected imagery to answer the CCIRs and EEIs as part of the IPB process. Exploitation occurs at all echelons of the MAGTF. Exploitation is the activity that converts information into intelligence.

The results of exploited and analyzed imagery and imagery data form the basis for IMINT reports and the derived products that are provided directly to tactical commanders, to the G-2/S-2 for inclusion into all-source intelligence products, and to other users. User needs are rarely satisfied by uninterpreted imagery; rather, IMINT exploitation planning and management should be coordinated with all-source intelligence production management and planning. The goal is effective and efficient use of limited resources while ensuring that IMINT production is focused on validated PIRs, intelligence requirements, and associated specified intelligence reporting criteria. This coordination includes:

- Determining the scope, content, and format for each product.
- Planning and scheduling the development of products.
- Assigning priorities among the various IMINT product requirements.
- Determining who needs what products and in what quantities.
- Allocating IMINT processing and exploitation resources.
- Coordinating production efforts with IMINT and all-source collection and dissemination activities.



Still frame imagery is exploited in the following three phases:

- First phase still frame imagery analysis is the rapid exploitation of newly acquired imagery and reporting of imagery-derived information (reconnaissance exploitation report [RECCEXREP]) within a specified time from receipt of imagery. This phase satisfies priority requirements of immediate need and/or identifies changes or activity of immediate significance. First phase still frame imagery analysis results in an initial photographic interpretation report (IPIR).
- Second phase still frame imagery analysis is the detailed exploitation of newly acquired imagery and the reporting of imagery-derived intelligence and information while meeting the production and timeliness requirements. Other intelligence discipline source material may support such imagery as appropriate. Second phase still frame imagery analysis yields a supplemental photographic interpretation report (SUPIR).
- Third phase still frame imagery analysis is the detailed analysis of all available imagery pertinent to a specific information requirement and the subsequent production and reporting resulting from this analysis within a specified time. This phase provides an organized detailed analysis of an imagery target or topic, using imagery as the primary data source but incorporating data from other sources as appropriate.

Likewise, motion imagery is exploited in the following three phases:

- First phase motion imagery analysis includes rapid, real-time callouts (i.e., size, activity, location, unit, time, and equipment [SALUTE] reports) of full motion video (FMV) via voice or chat.
- Second phase motion imagery analysis encompasses initial FMV annotated stills and video. Second phase motion imagery can supplement first phase motion imagery.
- Third phase motion imagery analysis includes in-depth analysis of FMV data, possibly fused with other sources, resulting in an intelligence product.

**Dissemination.** All echelons of the MAGTF generate information; therefore, the information must flow up and down the echelons of command. Dissemination is the process for providing the MAGTF and other users with products for all operations, including navigation, targeting, operational planning, mission rehearsal, and support to modeling and simulations. Imagery intelligence products are disseminated through all available delivery methods, including multisecurity level, Web-based, accessible storage devices that maintain imagery and IMINT relevant to the customer.

### **Imagery-Derived Products**

Imagery-derived products are secondary products that can be disclosed and released to coalition partners. They are useful for a variety of planning and decisionmaking activities. Several of the most commonly requested products include beach studies, helicopter landing zone (HLZ) studies, and raid studies.

**National Imagery Interpretability Rating Scale.** Still and motion imagery are also rated for quality of the imagery acquired from various types of imaging systems. The National Imagery Interpretability Rating Scale (NIIRS) is considered the standard for rating image quality by most imagery analysts and scientists. The NIIRS defines different levels of image quality/interpretability based on the types of tasks an analyst can perform with images of a given NIIRS

rating. The idea is that imagery analysts should be able to perform more demanding interpretation tasks as the quality of the imagery increases. Examples of these scales are in appendices D and E.

**Imagery Intelligence Text Products.** Imagery intelligence text products are selected to meet the specific needs of the commander. Appendix F provides the format and instructions for completing the RECCEXREP, the IPIR, and the SUPIR.

The RECCEXREP is used to report the results from the first rapid analysis of imagery, including the debriefing of the aircrew when possible. It addresses the targets requested in the original imagery collection mission tasking, normally with each target addressed separately. It is prepared by intelligence personnel, such as the imagery intelligence platoon (IIP), MAW, or Marine logistics group (MLG), based on input from the supporting collecting unit's intelligence section. The report is then disseminated in accordance with the dissemination plan. The specified time limit in which the RECCEXREP must be completed and disseminated must be in accordance with unit standing operating procedure (SOP).

The IPIR provides information regarding tasked imagery collection missions not previously reported (e.g., in the RECCEXREP); when extensive or detailed data from a systematic review of the imagery is required; or when the rapid response required by the RECCEXREP would be hindered by the format, size or quality of the imagery involved. It also is prepared by the IIP (with input from the supporting collecting unit's intelligence section) and disseminated in accordance with the dissemination plan. The timeline for completing this report will be in accordance with the unit SOP.

The SUPIR provides information not previously included in a RECCEXREP or IPIR. It reports on significant targets covered by the mission and other required supplemental data. It is prepared by intelligence personnel, such as the IIP, MAW, or MLG, based on input from the supporting collecting unit's intelligence section. The report is then disseminated in accordance with the dissemination plan. The specified time limit in which the SUPIR must be completed and disseminated will be in accordance with unit SOP.

**Size, Activity, Location, Unit, Time, and Equipment Report.** The standard SALUTE report is used to report any known or suspected enemy activity. It may also be used to report any characteristics of the AO that affect mission accomplishment. The SALUTE report may be used by a VMU, ground reconnaissance unit, aircrew, or other personnel to report key information obtained during ongoing imagery collection operations. This report will be disseminated in accordance with the dissemination plan: generally from the collector to the SARC or directly from the collector to other supported units.

### **G-2/S-2 Role in the Intelligence Cycle**

Figure 1-2, on page 1-12, depicts the G-2/S-2 role in the intelligence cycle and highlights the relationship of IMINT to MAGTF intelligence requirements and operations. Intelligence requirements can be complex and challenging; rarely will a single intelligence discipline, source, or sensor provide the complete answer to a request. Specific data must be processed and all of the seemingly unrelated, individual pieces of information must be evaluated, analyzed, and integrated into a usable, fused, all-source intelligence product that satisfies particular CCIRs. The planning process is discussed in greater detail in chapter 5.

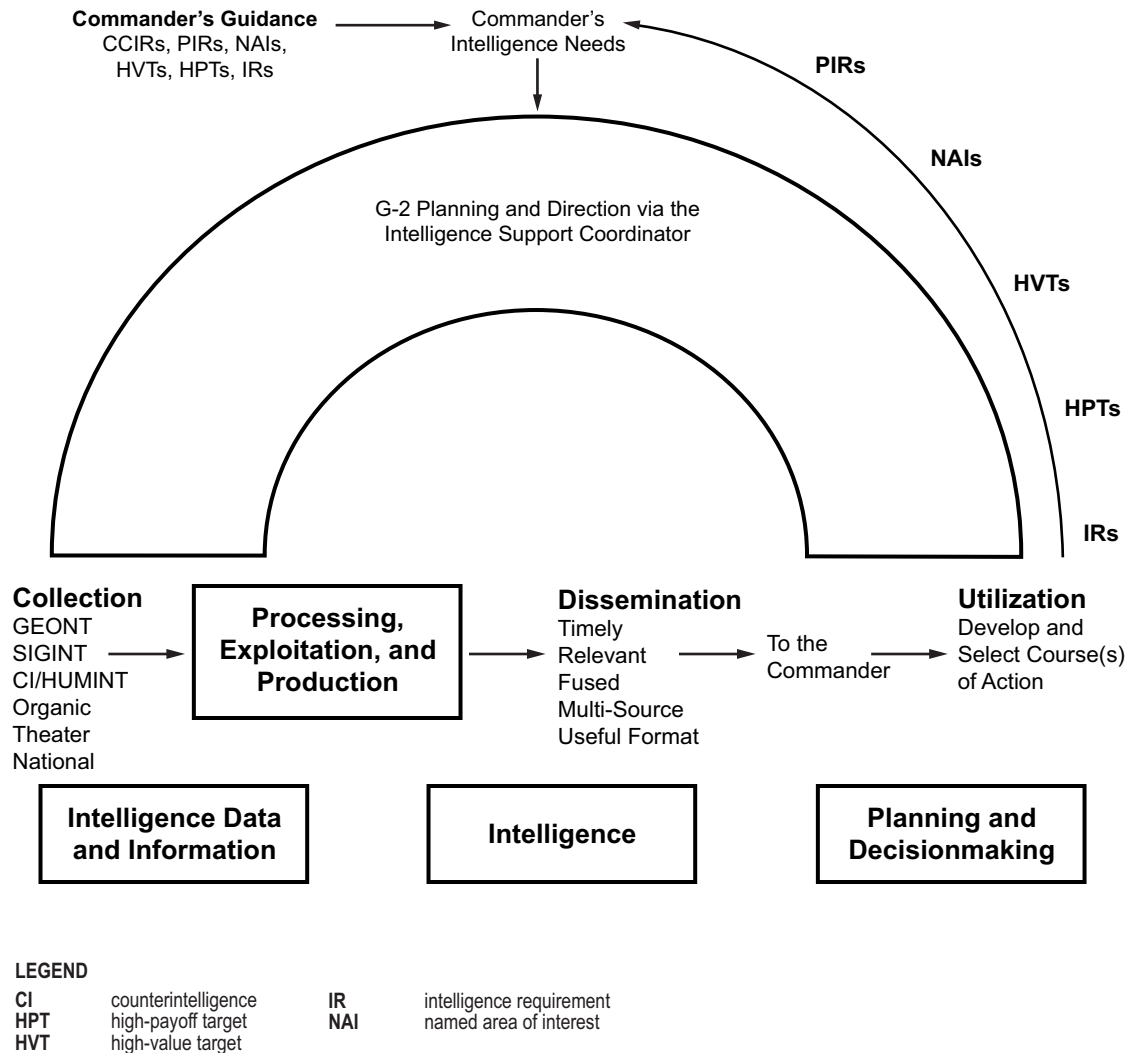

Figure 1-2. Intelligence Officer's Role in the Intelligence Cycle.

## LEVELS OF IMAGERY INTELLIGENCE

The MAGTF relies on tactical, theater, and national imagery to support planning and operations. A goal of imagery architecture development is to ensure that imagery products are available to support the MAGTF during all phases of every operation, regardless of geographic location (see fig. 1-3 on page 1-13). External imagery support assists the MAGTF during pre-deployment planning and imagery archive development. It also enables the MAGTF to view denied portions of the AO. As the MAGTF transits to the AO, imagery support is provided by a combination of national and theater assets. Once a MAGTF is within the AO, its organic assets will take on a greater role in providing imagery support.

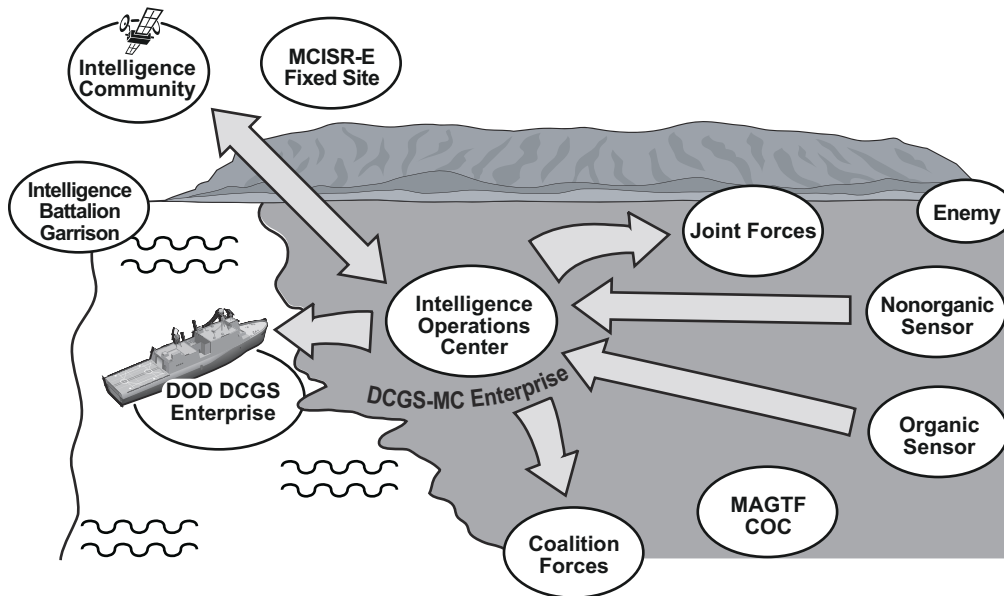

Figure 1-3. Imagery Architecture from IOC to COC.

### National Imagery Intelligence

The MAGTF CMs submit requirements for national IMINT support to the appropriate departmental requirements office (DRO) via the appropriate operational chain of command (see fig. 1-4 on page 1-14 and fig. 1-5 on page 1-15). The DRO used is determined by the operational situation and operating environment. As a general rule, all continental United States-based exercises, pre-deployment planning, and/or requirements mandated by the United States Code, Title 10, *Armed Forces*, are submitted via the chain of command to the United States Marine Corps DRO. Once a MAGTF is underway or deployed, requirements are submitted via the operational command for action by the Defense Intelligence Agency (DIA) DRO.

### Tactical Imagery Intelligence

Organic collectors of imagery and imagery-related information can support either routine or time-sensitive tactical intelligence. Because MAGTFs are task-organized, their organic capabilities and the degree of external support they require can vary.

Chapters 3 and 4 address Marine Corps imagery organizations and capabilities organic to MAGTFs. Examples of the types of external imagery support the MAGTF may require are discussed in the following subparagraphs.

**Pre-deployment.** The MAGTF may require the following pre-deployment support:

- MAGTF imagery storage devices loaded with current imagery.
- Pre-deployment packages (e.g., external hard drives, CD ROM[compact disc read-only memory]).

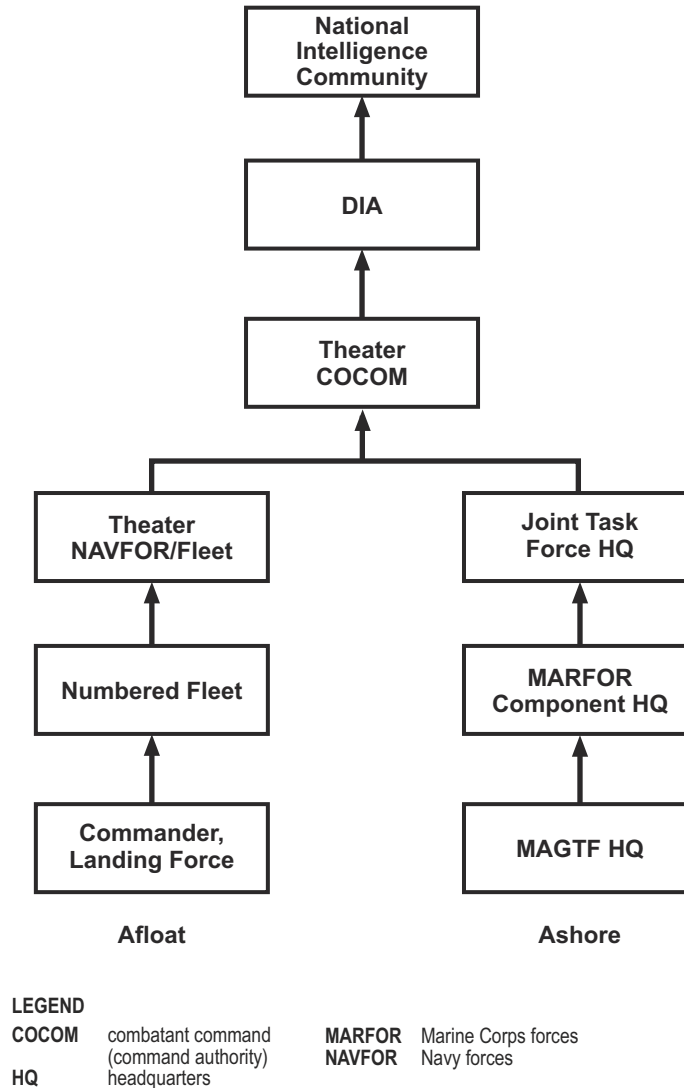
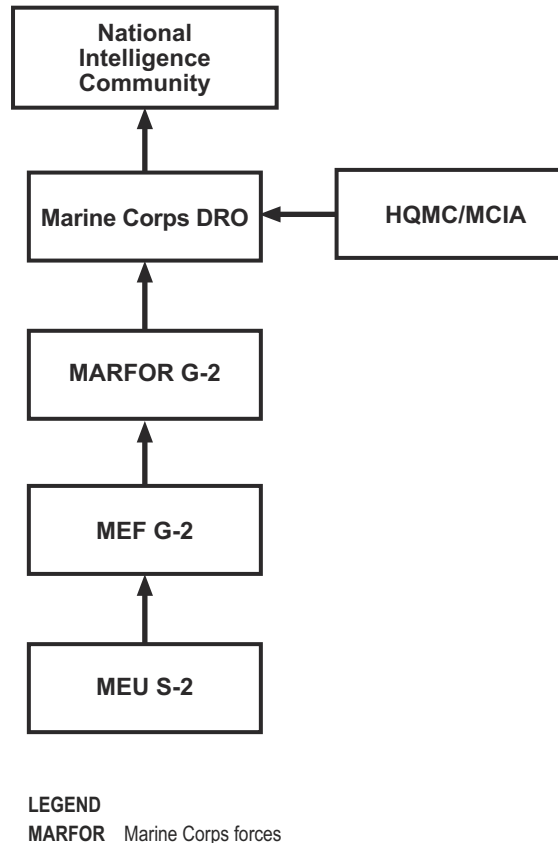

**Figure 1-4. External Imagery Support Request Chain.**

- Digital imagery database:
  - Area coverage baseline.
  - Baseline target/mission data.
  - Geospatial information.
  - Image maps.

***En route to Area of Operations.*** The MAGTF may require the following support en route to the AO:

- Reachback capability for updated imagery.
- Automatic/profiled update.
- Target-update images.
- Special area imagery.



**Figure 1-5. Internal Imagery Support Request Chain.**

**Area of Operations.** The MAGTF may require the following support at the AO:

- Reachback and pull capabilities.
- MAGTF operations plan support:
  - Landing zone (LZ) analysis.
  - Mission planning.
  - All-source visualization.
- Air tasking order (ATO) cycle support, including special area imagery.

### Theater Imagery Intelligence

Combatant commanders play a significant role in providing imagery support to MAGTFs due to the critical need for component interoperability during joint operations. Joint and theater IMINT is provided by the imagery assets organic to the combatant commander. Their joint intelligence operation centers (JIOCs) and joint analysis centers fulfill operational IMINT requirements of component, subordinate intelligence centers and joint task forces (JTFs).

# CHAPTER 2

## ORGANIZATIONS AND RESPONSIBILITIES

This chapter describes the roles and responsibilities of organizations and personnel conducting and supporting IMINT operations.

### **Marine Expeditionary Force Key Personnel Responsibilities**

Within the MEF, the key personnel who have specific responsibilities for imagery intelligence operation are the commander, the G-2 staff and intelligence battalion, other staff sections, and intelligence officers at MEF major subordinate commands.

### **Role of the Commander**

The responsibilities of the commander for imagery intelligence are command attention, intelligence requirements, resource allocation, and communications and information systems support.

**Command Attention.** Intelligence is an essential responsibility of command. The commander's involvement in the intelligence process includes focusing and supporting the intelligence effort, participating in the intelligence process, using intelligence, and providing personal evaluation of the intelligence effort.

**Intelligence Requirements.** The commander focuses intelligence in general and imagery collection in particular by communicating the commander's intent and planning guidance and the CCIRs, of which PIRs are a part. These later requirements drive all intelligence collection, production, and dissemination activities.

**Resource Allocation.** Imagery intelligence collection platforms are a high demand, low density asset. Some MAGTF imagery collection platforms have additional mission roles. Consequently, they may be tasked to perform command and control, targeting, electronic warfare (EW), or other intelligence collection missions in addition to imagery collection. Therefore, when it comes to IMINT operations, the commander's role in mission prioritization of organic imagery airborne collection and other IMINT assets is particularly important. A logical, detailed, and realistic concept of intelligence support, developed in accordance with the commander's intent and CONOPS, will facilitate the appropriate allocation of intelligence capabilities between the MAGTF's main and supporting efforts, as well as between intelligence support to current operations and the planning efforts for future operations.

**Communications and Information Systems Support.** The commander must assess the communication and information systems (CIS) requirements for intelligence against all competing MAGTF CIS's needs to ensure the required support is provided. Ultimately, the extent to which a MAGTF can request/receive JTF, theater, and national imagery support is a function of the connectivity and throughput of this CIS from the tactical level to theater and national levels.

**Marine Expeditionary Force Command Element: G-2 Section and the Intelligence Battalion**

Within the G-2 section and intelligence battalion, key personnel that have specific responsibilities for imagery intelligence operation are the AC/S G-2, G-2 operations officers, G-2 plans officer, intelligence battalion commander/intelligence support coordinator, collection management/dissemination officer, surveillance and reconnaissance center officer in charge (OIC), the production and analysis company commander, and the imagery intelligence platoon commander.

**Assistant Chief of Staff G-2.** The AC/S G-2 has staff responsibility for intelligence and intelligence operations—including IMINT (see fig. 2-1 on page 2-3 and fig. 2-2 on page 2-4). The commander relies on the intelligence officer to keep him informed about the weather and terrain, as well as the capabilities, status, and intentions of enemy forces. The MEF AC/S G-2 uses the intelligence operations plan to formulate and validate intelligence requirements; coordinate intelligence priorities; integrate collection, production, and dissemination activities; allocate resources; assign specific intelligence and reconnaissance missions to subordinate elements; and supervise all intelligence and reconnaissance efforts. The key all-source and IMINT responsibilities of the AC/S G-2 include—

- Developing and answering outstanding CCIRs, PIRs, and intelligence requirements by planning, directing, integrating, and supervising organic IMINT and multidiscipline intelligence operations conducted by the MEF and supporting organizations.
- Preparing appropriate IMINT and other intelligence and reconnaissance plans and orders for the MEF, and reviewing and coordinating the IMINT and all-source intelligence plans developed by other organizations.
- Submitting requests to higher headquarters for JTF, theater/national IMINT systems to support all-source and IMINT collection, production, and dissemination requirements.
- Ensuring IMINT/other intelligence information is processed, analyzed, incorporated (where appropriate in all-source intelligence products), and disseminated to appropriate MEF and external units.
- Evaluating JTF, theater, and national IMINT and all-source intelligence support and adjusting stated intelligence requirements when necessary.
- Identifying and correcting deficiencies in IMINT and other intelligence and reconnaissance personnel and equipment.
- Incorporating exercise IMINT into training exercises to improve individual, collective, and unit readiness within the MEF.
- Facilitating the use of IMINT and other intelligence to support the planning and execution of MEF operations.

**G-2 Operations Officer.** The G-2 operations officer works directly for the AC/S G-2 and provides support to the commander and the MEF command element for current and future operations. The all-source and IMINT responsibilities of the G-2 operations officer include—

- Coordinating and providing intelligence support (including key IMINT support) to the commanding general, the G-3 operations section, and the remaining MEF command element battle staff.
- Serving as the G-2 representative to the MEF command element crisis action team.



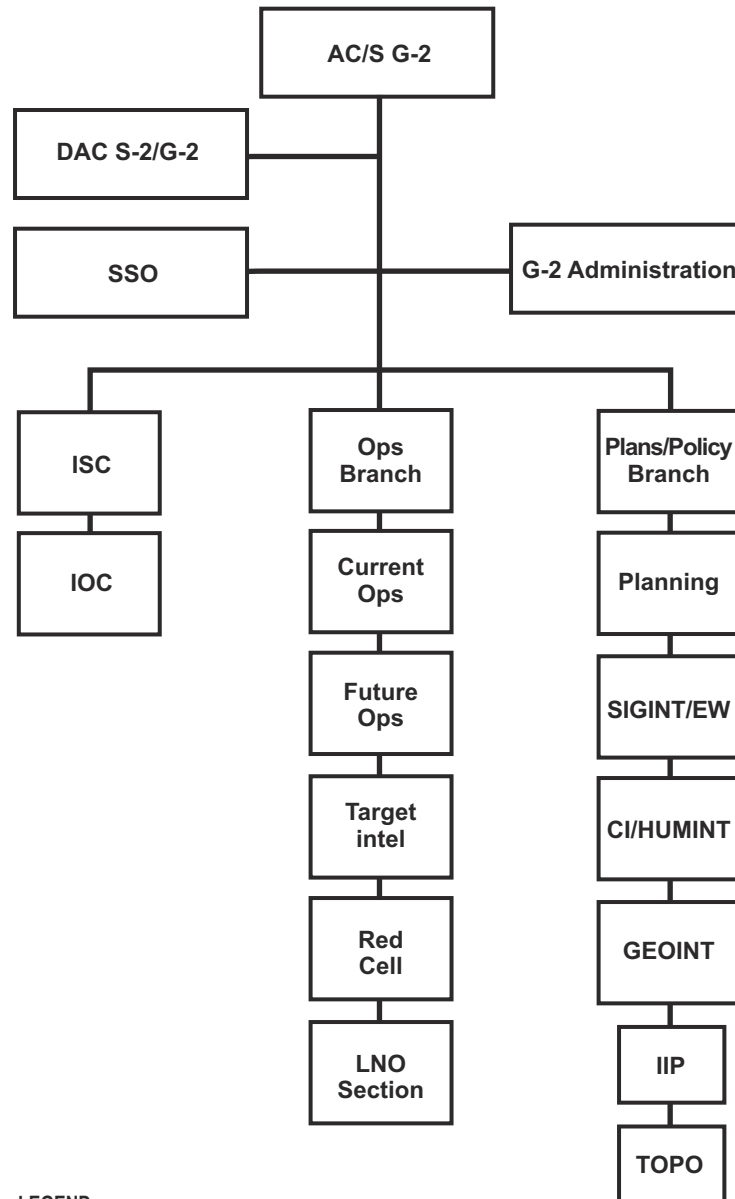

**LEGEND**

CI	counterintelligence	LNO	liaison officer
DAC	Defense Intelligence Agency (DIA)	Ops	operations
Intel	Counterintelligence intelligence	SSO	special security officer

**Figure 2-1. Marine Expeditionary Force G-2 Division Principal Staff Officers and Relationships.**

- Providing, coordinating, and supervising intelligence support to the MEF command element combat operations center (COC), future operations cell (FOC), and force fires.
- Planning, directing, and supervising the threat or red cell.
- Providing recommendations regarding CCIR, PIR, and intelligence requirement validation, prioritization, and tasking to both the AC/S G-2 and the ISC.
- Coordinating and supervising the transition of intelligence planning and operations from G-2 plans to G-2 future operations, and from G-2 future operations to G-2 current operations, in order to support the MEF’s single battle transition process.

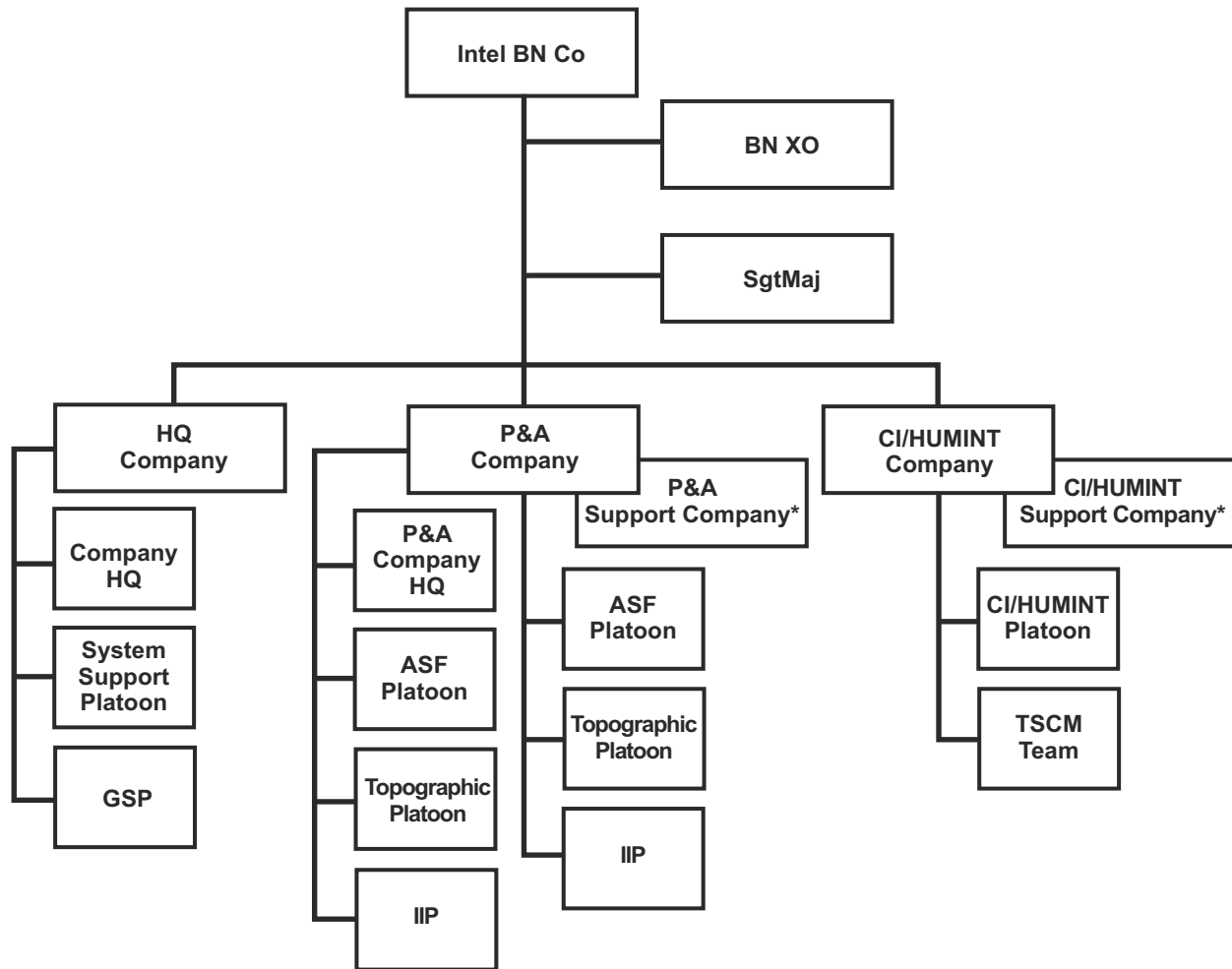

\*3d Intelligence Battalion does not have a P&A support company or a CI/HUMINT support company.

**LEGEND**

<b>ASF</b>	auxiliary security force	<b>HQ</b>	headquarters
<b>BN</b>	battalion	<b>SgtMaj</b>	sergeant major
<b>CI</b>	counterintelligence	<b>TSCM</b>	technical surveillance countermeasures
<b>Co</b>	commanding officer	<b>XO</b>	executive officer
<b>GSP</b>	ground sensor platoon		

**Figure 2-2. Intelligence Battalion.**

- Planning, directing, and supervising MEF liaison officers or teams to external commands (e.g., the JTF and joint functional components headquarters) and intelligence organizations.
- Coordinating with the operations officers and MEF major subordinate commands (MSC) G-2/S-2s to ensure unity of effort of all MEF intelligence operations.
- Providing intelligence input and other support to MEF warning and fragmentary orders and to all other operations-related reporting (e.g., periodic situation reports).
- Coordinating intelligence training for the MEF G-2 section and providing oversight for and implementation of the MEF G-2 intelligence training program.
- Accomplishing other intelligence support tasks as directed by the AC/S G-2.

**G-2 Plans Officer.** The G-2 plans officer works directly for the AC/S G-2 and provides intelligence support to the G-3 future plans cell. The key all-source and IMINT responsibilities of the G-2 plans officer include—

- Planning the MEF concept of intelligence operations for approval by the AC/S G-2, and its subsequent implementation by the ISC based upon the mission, threat, commander's intent, guidance, and CONOPS. This concept of intelligence operations includes a supporting IMINT CONOPS.
- Leading, coordinating, and providing intelligence support to the MEF G-5 future plans section.
- Planning and coordinating intelligence support requirements for the deployment of intelligence elements and resources into the AO.
- Providing recommendations regarding PIR and intelligence requirement validation, prioritization, and taskings to both the AC/S G-2 and the ISC.
- Coordinating with the ISC and G-2 to develop the Annex B (Intelligence), Annex H (METOC), and Annex M (GI&S), as well as their supporting appendices (e.g., Appendix 7, Imagery Intelligence), of MEF operation plans (OPLANs). And in addition, providing intelligence input to other annexes of MEF OPLANs.
- Keeping the G-2 section, other command element staff sections, intelligence liaison personnel, augmentees, and personnel apprised of MEF intelligence planning actions and requirements.
- Identifying requirements and providing recommendations to the G-2 operations officer regarding MEF intelligence liaison teams to external commands (e.g., the JTF or other component headquarters) and intelligence agencies.
- Coordinating and developing policies for MEF intelligence, counterintelligence, and reconnaissance operations.
- Planning, directing, and supervising the MEF G-2's GEOINT (i.e., imagery, METOC, and GI&S), counterintelligence/HUMINT, and SIGINT.
- Accomplishing other intelligence support tasks, as directed by the AC/S G-2.

**Intelligence Battalion Commander/Intelligence Support Coordinator.** The intelligence battalion commander is responsible for TCPED of intelligence and for providing counterintelligence support to the MEF, MEF MSCs, subordinate MAGTFs, and other commands, as directed. While in garrison, the intelligence battalion commander is responsible for organizing, training, and equipping detachments that will support either MAGTFs or other designated commands by executing integrated collection, intelligence analysis, production, and dissemination of intelligence products.

While operational, the intelligence battalion commander is dual-hatted, also serving as the ISC under the direct staff cognizance of the MEF AC/S G-2. As the ISC, the intelligence battalion commander is responsible to the MEF AC/S G-2 for the overall planning and execution of MEF

all-source intelligence operations. Specific all-source and key IMINT responsibilities of the ISC during actual operations include—

- Implementing the concept of intelligence operations developed by the G-2 plans officer and approved by the AC/S G-2.
- Establishing and supervising operation of the MEF IOC (see fig. 2-3), which includes the support cell, the SARC, and the P&A cell. The IOC will normally be collocated with the MEF command element’s main command post.
- Developing, consolidating, validating, and prioritizing recommended PIRs and intelligence requirements to support MAGTF planning and operations.
- Planning, developing, integrating, and coordinating MEF intelligence collection, production, and dissemination plans. Such plans include the effective organic and external integration and employment of MAGTF IMINT as well as staff cognizance of MEF GEOINT; counterintelligence; HUMINT; SIGINT; ground sensor platoon; ground reconnaissance; and tactical air reconnaissance intelligence collections, production, and dissemination operations.

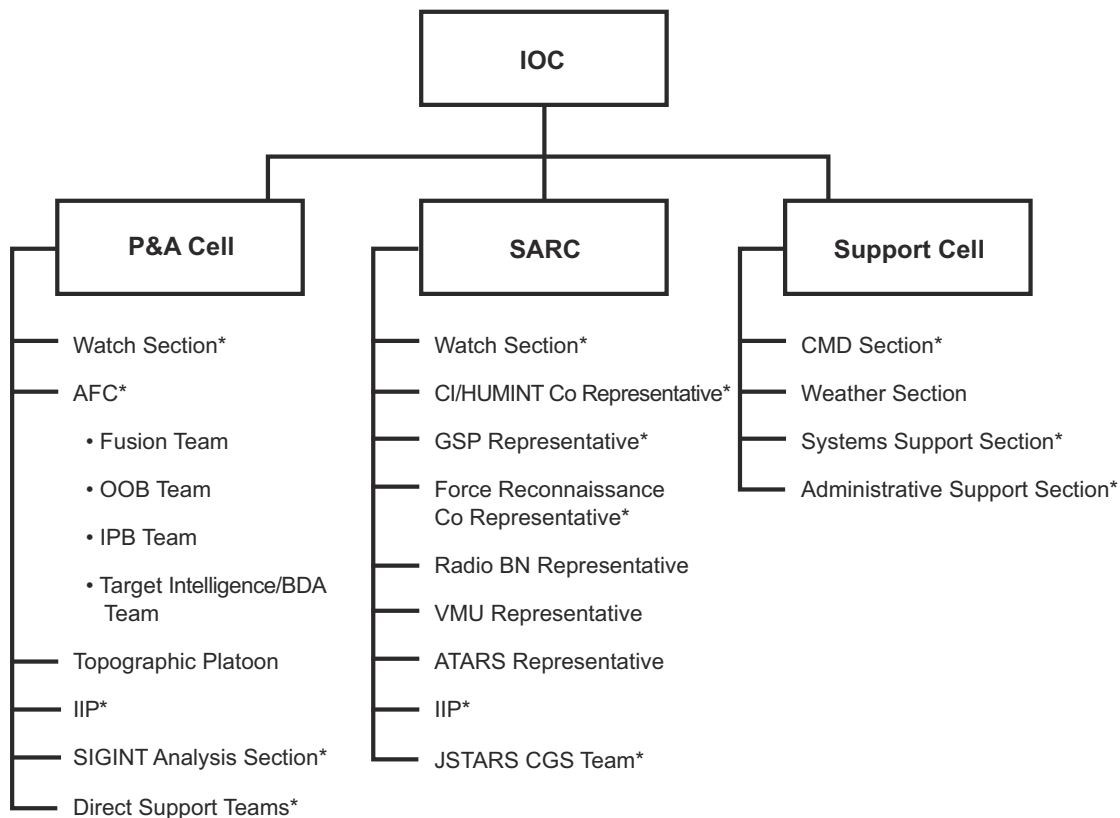

\*Personnel provided wholly or partially by intelligence BN.

**LEGEND**

<b>AFC</b>	all-source fusion center	<b>Co</b>	company
<b>BN</b>	battalion	<b>GSP</b>	ground sensor platoon
<b>CI</b>	counterintelligence		

**Figure 2-3. Intelligence Operations Center.**

- Developing, in conjunction with the G-2 operations officer and G-2 plans officer, Annex B (Intelligence), Annex H (METOC), and Annex M (GI&S), as well as their supporting appendices (e.g., Appendix 7, Imagery Intelligence), of MEF operation orders (OPORDs). And in addition, providing intelligence input to other annexes of MEF OPORDs.
- Planning, developing, integrating, and coordinating intelligence and counterintelligence support for the commander's estimate, situation development, I&W, force protection, targeting, and combat assessment.
- Managing and fusing the threat inputs from subordinate units, external commands, and intelligence agencies into the MEF COP/common tactical picture (CTP).
- Providing intelligence support to the G-2 sections at both the MEF and its MSCs.
- Preparing intelligence and counterintelligence estimates to support G-2 plans.
- Planning, developing, and coordinating intelligence CIS architecture, including its integration with and support of MEF IMINT and other intelligence and reconnaissance requirements.
- Coordinating and integrating MEF IMINT and all-source intelligence operations with other Service components, JTF, the joint intelligence support element (JISE), theater JIOC or joint analysis center, and national intelligence agencies, including all aspects of intelligence reachback support such as the Marine Corps Intelligence Activity (MCIA).
- Assisting with the evaluation and improvement of both MEF IMINT and all-source intelligence operations.
- Accomplishing other intelligence support tasks as directed by the AC/S G-2.

**Collection Management/Dissemination Officer.** The collection management/dissemination officer (CM/DO) is sourced from the S-3 section of the intelligence battalion. The CM/DO is a key subordinate to the intelligence battalion commander/ISC during operations. The CM/DO is responsible for formulating detailed intelligence collection requirements (ICRs) and intelligence dissemination requirements. He is also responsible for tasking and coordinating internal and external operations to satisfy these requirements.

The CM/DO receives PIRs, intelligence requirements, and direction from the ISC; he then plans and manages the employment of organic and supporting collection and dissemination resources (Appendix 16, Intelligence Operations Plan, to Annex B [Intelligence]). Additionally, the CM/DO is responsible for validating and forwarding MEF and MSC collection requests for theater and national IMINT to the appropriate agencies for action. The CM/DO is responsible for coordinating intelligence CIS requirements and maintaining awareness of available CIS connectivity both inside the MAGTF and with key external organizations. During operations, the CM/DO works within the support cell. The CM/DO (in coordination with the P&A company commander, the SARC OIC, G-2 operations officer, and the G-6) determines and coordinates the collection effort of PIRs/intelligence requirements. The CM/DO is responsible to the ISC for the following several important IMINT-related tasks:

- Recommending dissemination priorities, developing intelligence reporting criteria, and advising on and selecting dissemination means.
- Developing and coordinating IMINT and all-source intelligence collection plans; coordinating and integrating these plans with MEF, other component, JTF, theater, and national intelligence production operations.

- Developing and coordinating IMINT and all-source intelligence dissemination plans and supporting networked communications architectures and coordinating and integrating these requirements with MEF, other component, JTF, theater, and national intelligence CIS and dissemination operations.
- Monitoring the flow of imagery requirements throughout the MAGTF and ensuring imagery products are delivered in a timely manner.
- Evaluating the effectiveness of MEF and supporting IMINT collection and dissemination operations.

***Surveillance and Reconnaissance Center Officer in Charge.*** The SARC OIC supervises the execution of intelligence collection and reconnaissance operations conducted by organic, attached, and direct support assets. The SARC OIC is responsible to the ISC for accomplishing the following specific IMINT-related tasks:

- Coordinating, monitoring, and maintaining the status of all ongoing organic imagery collection operations, including the following:
  - Missions, tasked ICRs, and reporting criteria for collection missions.
  - Locations and times for all pertinent fire support control measures.
  - Primary and alternate CIS plans, which support both routine and time-sensitive requirements for IMINT collectors.
- Ensuring other MAGTF command and control (C2) nodes, such as the current operations center or force fires, are apprised of ongoing IMINT and other intelligence and reconnaissance operations.
- Receiving routine, time-sensitive IMINT-related reports from dispersed collection elements and cross-cueing among intelligence collectors.
- Disseminating IMINT reports according to standing PIR/intelligence requirements, intelligence reporting criteria, dissemination plans, and the current tactical situation.

***Production and Analysis Company Commander.*** The P&A company commander has primary responsibility for coordinating intelligence processing and production requirements directed by the MEF, including the following:

- Planning, directing, and managing operations of the all-source fusion platoon (AFP), IIP, METOC, topographic platoon, direct support teams, and other P&A elements, as directed.
- Coordinating and integrating P&A company operations, estimates, and products with the MEF G-2 sections.
- Planning, managing, and maintaining all-source and GEOINT data.
- Operating, maintaining, and integrating intelligence processing and production systems.
- Analyzing and fusing GEOINT with other intelligence to create tailored all-source intelligence products that satisfy all supported commanders' PIRs and intelligence requirements.

- Developing and maintaining current and future intelligence situational, threat, and environmental assessments and target intelligence based upon all-source analysis, interpretation, and integration.
- Managing and fusing the threat COP/CTP inputs from subordinate units, external commands, and intelligence agencies into the MEF command element's threat COP/CTP.

**Imagery Intelligence Platoon Commander.** The IIP commander is responsible for planning and providing the MEF, and other commands as directed, with imagery products to support operations. Tasks specific to the IIP commander include the following:

- Exploiting and analyzing all-source, multisensor imagery to derive intelligence pertaining to installations, dispositions, strengths, and activities of various conventional and nonconventional forces.
- Planning and tasking multisensor platforms (both organic platforms and platforms external to the MAGTF).
- Managing imagery data and exploitation.
- Providing imagery-derived products and reports to the MEF commander and other pertinent commanders.
- Conducting liaison activities with the Service intelligence center and pertinent external agencies to obtain imagery products that support MEF intelligence requirements.

#### **Marine Expeditionary Force Command Element: Other Staff Sections**

Other staff sections that have specific responsibilities for imagery intelligence are AC/S G-1, AC/S G-3, AC/S G-4, AC/S G-5, and AC/S G-6.

**Assistant Chief of Staff G-1—Personnel Section.** The AC/S G-1 provides personnel support to the IMINT effort, including coordinating augmentation by qualified personnel. Requests for IMINT personnel augmentation will be developed by the MEF AC/S G-2 and provided to the AC/S G-1 for either internal sourcing or forwarding to higher headquarters for global sourcing.

**Assistant Chief of Staff G-3—Operations Section.** The AC/S G-3 is responsible for planning, coordinating, and supervising the movement and employment of maneuver units and fires. Imagery intelligence provides valuable support for each of those tasks. Consequently, G-3 personnel must understand the capabilities of the various IMINT collection systems, exploitation capabilities and requirements, and the advantages and limitations of different types of imagery and IMINT products. Additionally, when planning current and future operations, the movement and employment of IMINT personnel and their supporting units must be coordinated between the AC/S G-2 and G-3. Since some imagery supporting units also provide nonintelligence capabilities, close coordination between the AC/S G-2 and G-3 is necessary for mission prioritization and deconfliction.

**Assistant Chief of Staff G-4—Logistics Section.** The AC/S G-4 is responsible for the logistic support of attached IMINT units. All policies, procedures, and other support requirements should be coordinated between the G-4 and the supported IMINT personnel as soon as possible. Special attention should be directed towards logistic requirements related to the unique (i.e., large/bulky) equipment organic to IMINT units.

**Assistant Chief of Staff G-5—Future Plans Section.** The AC/S G-5 is responsible for all long-range (i.e., future) planning and joint planning matters. Normally, an AC/S G-5 is found only at the MEF and Marine Forces levels; at lower echelons of the MEF, the AC/S G-3 is responsible for the future planning task. Assistant chief of staff G-5 personnel must understand the capabilities of the various IMINT collection systems, exploitation capabilities and requirements, and the advantages and limitations of different types of imagery and IMINT products.

**Assistant Chief of Staff G-6—Communications Systems Section.** The AC/S G-6 provides and protects interior and exterior CIS connectivity and operations for the MEF, which includes providing the communication pathways, network accesses, and frequencies for IMINT organizations organic, attached to, and/or supporting the command. Therefore, the AC/S G-6 requires significant systems knowledge across IMINT and all-source intelligence CIS.

### **Intelligence Officers at Marine Expeditionary Force Major Subordinate Commands**

The MSC intelligence officers must understand imagery and IMINT, as well as their capabilities and uses. Additionally, they must be able to integrate IMINT support with other command intelligence and reconnaissance operations. Close coordination among all unit intelligence officers can identify opportunities where small adjustments to IMINT requirements yield results that satisfy the collection/production tasks for more than one unit. Key IMINT-related tasks for MSC intelligence officers include—

- Planning and implementing a concept for intelligence support based on the mission, CONOPS, and commander's intent.
- Providing centralized direction for command intelligence operations, including IMINT elements attached to/placed in direct support of the unit.
- Consolidating, validating, and prioritizing unit intelligence requirements and IMINT needs.
- Submitting consolidated requests for external IMINT support to the MEF command element.
- Coordinating operational and CIS links in support of external IMINT collection and production elements and operations.
- Providing timely and accurate feedback from supported units regarding their level of satisfaction with the IMINT support provided.

---

## **NATIONAL IMAGERY ORGANIZATIONS**

The national imagery organizations are the Office of the Director of National Intelligence, National Geospatial-Intelligence Agency (NGA), national intelligence support team (NIST), the National Reconnaissance Office (NRO), and the DIA.

### **Office of the Director of National Intelligence**

Two elements of the Office of the Director of National Intelligence are the Director of National Intelligence (DNI) and the DNI organization.



***The Director of National Intelligence.*** The DNI serves as the head of the intelligence community (IC) and is the principal advisor to the President, the National Security Council, and the Homeland Security Council for intelligence matters related to national security. Additionally, the DNI both oversees and directs the implementation of the National Intelligence Program. The President appoints the DNI and the principal deputy director with the advice and consent of the Senate. The responsibilities of the Director of National Intelligence include—

- Leading the IC.
- Overseeing the coordination of foreign relationships between elements of the IC and the intelligence services of foreign governments.
- Establishing requirements and priorities for collection, analysis, production, and dissemination of national intelligence.
- Coordinating reform of security clearance and acquisition processes.
- Ensuring IC financial statements are auditable.
- Supporting legislative, legal, and administrative requirements.
- Ensuring compliance with statutory and Presidentially-mandated responsibilities.
- Transforming the IC into a unified, collaborative, and coordinated enterprise.

***Director of National Intelligence Organization.*** The DNI organization is composed of the DNI staff and IC mission and support activities. The DNI staff is responsible for developing IC policy and overseeing its implementation. It is also responsible for preparing the National Intelligence Program budget. The mission and support activities are responsible for providing IC-wide substantive intelligence, counterintelligence strategy and strategic analysis, research and development, and training and education. The Director of Intelligence (DIRINT) staff is responsible for synchronizing and integrating efforts across Office of the Director of National Intelligence.

### **National Geospatial-Intelligence Agency**

The NGA has specific authorities, produces various products, provides various services, manages the GEOINT workforce, and provides deployable support teams.

***National Geospatial-Intelligence Agency Authorities.*** By law, the NGA is a combat support agency (CSA) as well as a national intelligence organization. As functional manager of GEOINT, the NGA is directly subordinate to the Secretary of Defense and the Under Secretary of Defense for Intelligence. The NGA is the primary source for GEOINT analysis and products at the national level. In addition to the GEOINT support identified in Joint Publication (JP) 2-01, *Joint and National Intelligence Support to Military Operations*, the NGA supports national and homeland security, defense policy and force structure, and advanced weapons and systems development.

***National Geospatial-Intelligence Agency Products.*** The NGA disseminates data and standard products. It also makes them available in repositories where GEOINT-trained personnel throughout the IC, including military personnel in the field, can access the data to develop their own GEOINT analysis and nonstandard products.

**National Geospatial-Intelligence Agency Services.** The NGA works with commercial imagery and geospatial data vendors to procure diverse unclassified imagery and geospatial information to support its customers, collaborative efforts with allies and coalition partners, other IC agencies, Department of Defense (DOD) organizations, and other civil and government entities.

**National Geospatial-Intelligence Agency Workforce.** The NGA provides GEOINT strategic workforce planning and specific training for general and specialized tradecraft skills through the National Geospatial-Intelligence College.

**National Geospatial-Intelligence Agency Deployable Support.** The NGA deploys a National Geospatial-Intelligence Agency support team (NST) in direct support of the Services, other IC organizations, and the JIOC at each combatant command (CCMD).

**National Intelligence Support Team**

National intelligence support teams are task-organized, national-level, all-source intelligence teams—generally consisting of DIA, National Security Agency (NSA), Central Intelligence Agency (CIA), and NGA personnel and equipment. They provide deployed commanders (generally at the JTF headquarters level) with coordination with national intelligence agencies, analytical expertise, I&W, special assessments, targeting support, streamlined and rapid access to national intelligence databases and other products, and assistance facilitating request for intelligence (RFI) management (see fig. 2-4).

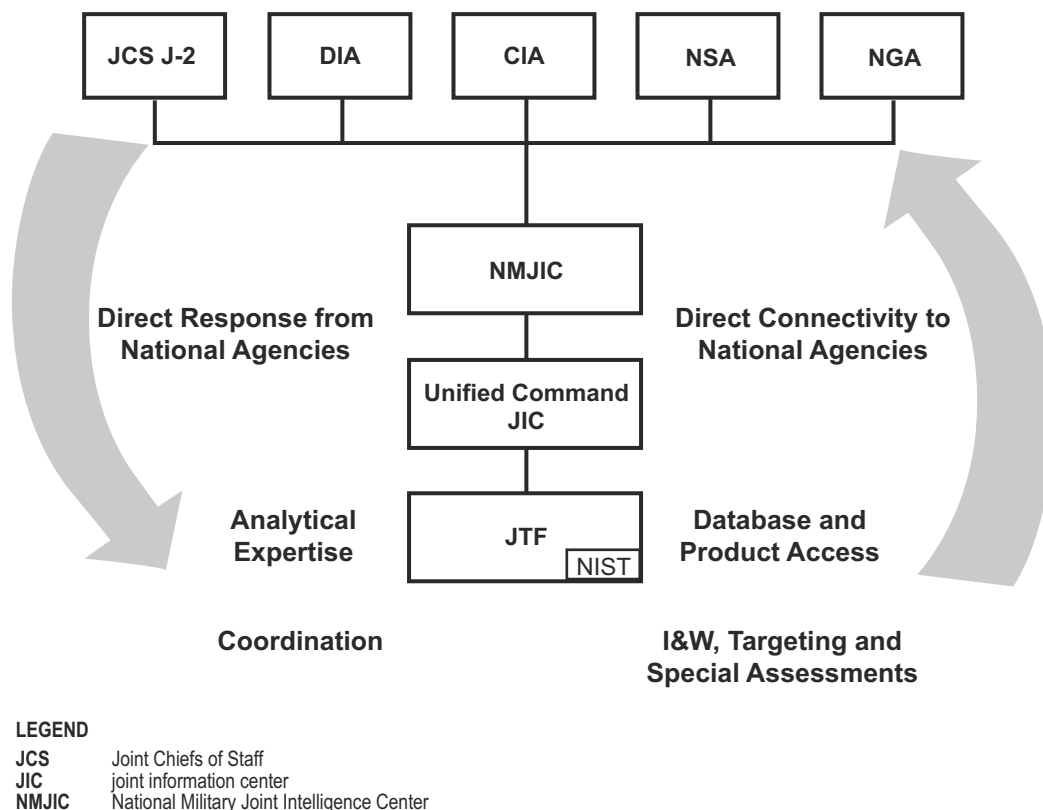
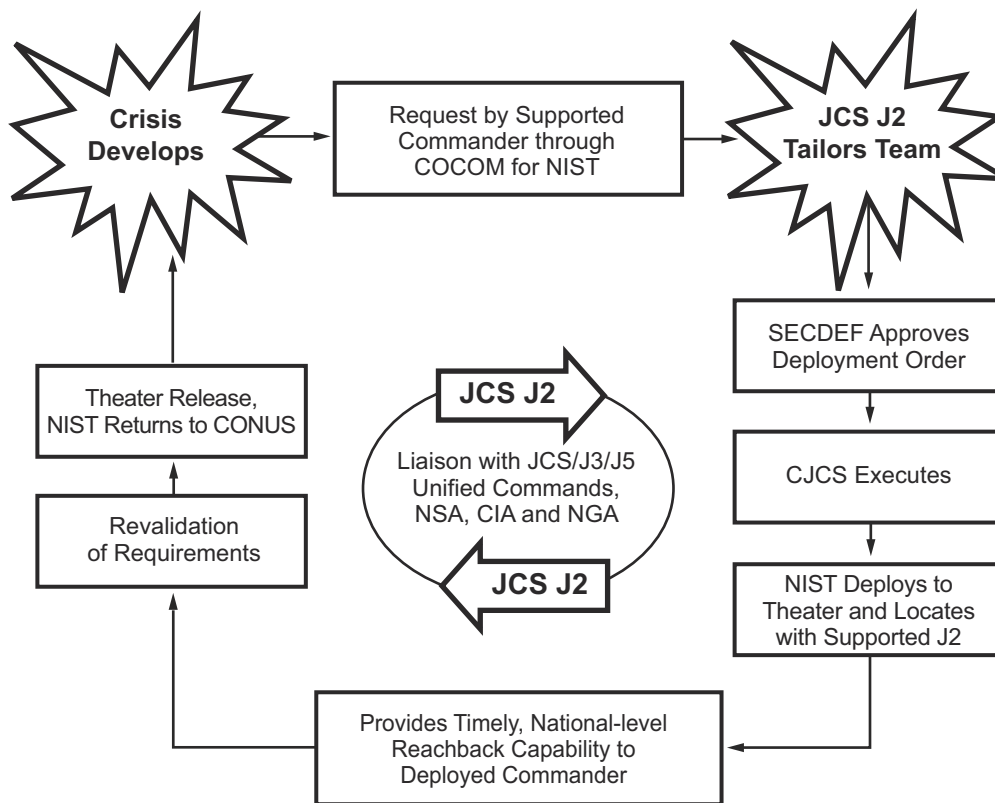

Figure 2-4. National Intelligence Support Team Capabilities.

**National Intelligence Support Teams Command and Control.** National intelligence support teams are managed by the DIA’s defense joint IOC. The DIA, through the joint staff J-2, controls each NIST for deployment and administrative purposes. See figure 2-5 for an overview of a NIST’s deployment cycle.

During operations, a NIST will typically be in direct support of the joint force commander (JFC). The NIST falls under the staff cognizance of the JTF J-2, performing intelligence support functions as tasked. The basic NIST CONOPS is to take the JTF J-2’s RFIs and collection and production requirements and discuss and deconflict these within the NIST to determine which element(s) should fulfill these requirements.

Each NIST element leader will maintain contact with their parent national intelligence organization and coordinate their actions with the NIST team chief. Intelligence generated by the NIST is available to the JTF J-2 JISE, the JFC, and other elements of the JTF with the usual caveats (i.e., restriction based on clearance and programs).



**LEGEND**  
 CJCS Chairman of the Joint Chiefs of Staff  
 CONUS continental United States  
 J-3 operations staff section  
 J-5 plans staff section  
 JCS Joint Chiefs of Staff

**Figure 2-5. National Intelligence Support Team Deployment Cycle.**

**National Intelligence Support Teams Composition and Capabilities.** The composition and capabilities of each deployed NIST are dictated by the mission, duration of the deployment, agencies represented, and capabilities required (see table 2-1). A NIST is not a self-contained element; it requires logistic and other support from the supported command (e.g., information systems technical support and an access-controlled secure area generally within the supported unit’s tactical sensitive compartmented information facility).

**Table 2-1. Notional Composition of a National Intelligence Support Team.**

CIA	CIA
2 analysts	2 analysts
2 communicators	2 communicators
Associated communications and information systems workstations	Associated communications and information systems workstations
NSA	NSA
5–12 personnel (analysts, technicians, and communicators)	1 imagery analyst
Associated communications and information systems workstations	1 geospatial analyst
	Associated communications and information systems workstations
Each NIST is task-organized to fulfill the supported commander’s intelligence requirements.	

A NIST’s organic capabilities generally encompass only intelligence and some unique CIS support. A NIST’s CIS capabilities are task-organized and a NIST may range from a single agency element’s voice connectivity to a fully-equipped NIST with JISE and Joint Worldwide Intelligence Communications System (JWICS) mobile integrated communications system video teleconferencing capabilities. For an example of the NIST’s deployed footprint with the JWICS Mobile Integrated Communications System, see figure 2-6. Current methods of operation rely on both agency and supported command-provided communications pathways to support the deployed NIST element.



**Figure 2-6. National Intelligence Support Team Joint Worldwide Intelligence Communications System Mobile Integrated Communications.**

**National Reconnaissance Office**

The NRO designs, builds, and operates the nation's reconnaissance satellites. These satellites comprise one of the primary collection sources for GEOINT data and provide significant imagery to support DOD requirements related to targeting and mapping. These data are used for I&W, monitoring of arms control agreements, and the planning and execution of military operations. Once GEOINT data is collected, processed, and stored, the NGA takes the lead with respect to analysis and access/distribution for both national and DOD customers.

**Defense Intelligence Agency**

The DIA is both a national and defense-level intelligence agency. It is also designated as a CSA. The DIA is subordinate to the Secretary of Defense and the Under Secretary of Defense for Intelligence. The DIA has various programs that it manages and has certain responsibilities and management roles within the IC.

***Defense Intelligence Agency Programs.*** The Director, DIA is the program manager of the General Defense Intelligence Program, which provides funding for the DIA and the intelligence organizations of each military department. The Director, DIA also manages a DIA program in the Military Intelligence Program, which includes select DIA programs and the intelligence resources of the eleven CCMDs. The Military Intelligence Program manages more than 500 military imagery analysts in support of the CCMDs.

***Defense Intelligence Agency Responsibilities.*** The Director, DIA is responsible for coordinating collection requirements between national-level organizations and theater users for national and airborne imagery.

***Defense Intelligence Agency Functional Management.*** The Director, DIA is the functional manager for the non-GEOINT-related components of measurement and signature intelligence (MASINT).

---

**MARINE CORPS SUPPORTING  
ESTABLISHMENT IMAGERY INTELLIGENCE ORGANIZATIONS**

The supporting establishment imagery intelligence organizations in the Marine Corps are Headquarters, Deputy Commandant for Capabilities Development and Integration; Systems Command; MCIA; and NSTs.

**Headquarters, United States Marine Corps**

Within Headquarters, United States Marine Corps (HQMC) there are two organizations that focus on imagery intelligence, Headquarters, Marine Corps-Imagery & Geospatial Intelligence Branch (HQMC-IPI) and HQMC, Department of Aviation.

***Imagery/Geospatial Plans and Policies Branch, Intelligence Department.*** The HQMC-IPI serves as the principal Marine Corps representative for the DIRINT within the national and joint GEOINT communities. The HQMC-IPI personnel are responsible for developing and coordinating Marine

Corps imagery and geospatial programs. Specific HQMC-IPI personnel responsibilities include the following:

#### External to the Marine Corps

- Representing the DIRINT in meetings with the national agencies and other Services regarding policies affecting the planning and direction, collection, processing and production, dissemination, and utilization of GEOINT.
- Coordinating and validating Marine Corps Service-level imagery special collections and standing requirements for submission to the NGA source directorate.
- Ensuring Marine Corps imagery and geospatial intelligence architectures are interoperable with primary and alternate national imagery dissemination paths.
- Conducting liaison with the NGA and the CIA Office of General Counsel regarding matters related to IMINT oversight and domestic coverage.
- Responding to the Freedom of Information Act Office for requests to the Marine Corps for imagery materials, products, and derivative textual information/analytical methodologies.

#### Internal to the Marine Corps

- Identifying and coordinating issues related to intra-Service imagery and geospatial intelligence to ensure that organic resources available to the Marine Corps are exploited fully.
- Establishing policy guidance for disseminating national-level imagery to the operating forces afloat or ashore.
- Coordinating with the Deputy Commandant for Combat Development and Integration, Capabilities Development Directorate, Marine Corps Systems Command (MARCORSYSCOM) and other HQMC staff elements on imagery and geospatial intelligence issues related to—
  - GEOINT requirements and capabilities.
  - Dissemination architectures.
  - The Marine Corps Concept Based Requirements System process for GEOINT.
- Sponsoring the annual Marine Corps GEOINT conference.

***Headquarters, Marine Corps, Department of Aviation.*** The Deputy Commandant for Aviation coordinates with Navy aviation elements to procure manned and unmanned tactical aviation platforms and sensors.

#### **Deputy Commandant for Combat Development and Integration**

The Deputy Commandant for Combat Development and Integration develops fully integrated warfighting capabilities—including doctrine, organization, training, materiel, leadership and education, personnel, and facilities—to enable the Marine Corps to field combat-ready forces.

#### **Marine Corps Systems Command**

Marine Corps Systems Command serves as the Commandant's principal agent for equipping the operating forces so they can accomplish their warfighting mission. Marine Corps Systems Command plans and manages research, development, and acquisition programs through equipment production and fielding for employment by MAGTF forces, including most equipment programs that support GEOINT.

**Marine Corps Intelligence Activity**

The MCIA is the Marine Corps' Service intelligence production center. In addition, the MCIA supports other Services and government organizations as appropriate. It provides the Marine Corps with intelligence for planning, training, operations, systems development, and exercises. The MCIA can be tasked to provide expeditionary warfare intelligence to support any national, theater, or operational command in the US Armed Forces. The MCIA's analysis and production supports not only the Marine Corps, but also national decisionmakers, theater commanders, and tactical warfighters.

**National Geospatial-Intelligence Agency Support Teams**

The NGA provides support teams to the Marine Corps with a specific mission, organization, and responsibilities.

***National Geospatial-Intelligence Agency Support Team Mission.*** The NST representatives train and work with the MEF, MSCs, and other intelligence personnel to integrate IMINT and GI&S and future National System for Geospatial Intelligence (NSG) capabilities into MEF operations. The NSTs also evaluate the use of IMINT and GI&S and NSG concepts and products supporting the MAGTF mission.

***National Geospatial-Intelligence Agency Support Team Organization.*** The NSTs are collocated with supported Marine Corp units and are an extension of both the NST-Marine Corps and the NGA staff officer. The NSTs provide direct access to the NGA geospatial libraries and support interoperability between the Marine Corps and the NGA. The NSTs execute all tasks in coordination with guidance provided by NST-Marine Corps, the NGA staff officer, and the MEF GEOINT chief.

***National Geospatial-Intelligence Agency Support Team Responsibilities.*** The responsibilities of the NST include the following:

- Serving as the focal point for NGA GEOINT activity within each MEF and assisting each MEF with identifying IMINT and GI&S requirements.
- Installing and maintaining NGA application software and new NGA prototype systems and products as they become available and familiarizing imagery personnel with the software applications.
- Training IIP and MEF intelligence personnel to use NGA data and applications for planning and integration into organizational systems.
- Developing, maintaining, and presenting demonstrations of current and projected GEOINT capabilities.
- Evaluating GEOINT software and data, reporting findings to NST-Marine Corps, the NGA staff officer, HQMC-IPI, MEFs, intelligence battalions, and topographic platoons.
- Coordinating actions affecting MAGTFs with NST-Marine Corps, the NGA staff officer, HQMC-IPI, MEFs, intelligence battalions, and IIPs.
- Providing technical support for NGA products used in MAGTF systems.
- Assisting with developing tactics, techniques, and procedures (TTP) to support the rapid generation of new data and/or intensification of existing data sets.

- Assisting with technical reviews of developmental data sets, products, systems, and associated documents to ensure standard NGA data are used and new GEOINT product requirements are promptly identified.
- Assisting the imagery analysts with the technical use of NGA and NSG products.
- Assisting with the integration of the NGA's NSG concept into existing MAGTF architectures and migration plans.



---

# CHAPTER 3

## MAGTF IMAGERY

### INTELLIGENCE UNITS AND ORGANIZATIONS

This chapter describes the missions, tasks, organization, and CONOPS for Marine Corps units responsible for conducting tactical IMINT.

---

#### IMAGERY INTELLIGENCE PLATOON INTELLIGENCE BATTALION

The IIP is responsible for certain missions and tasks; it is organized to provide IMINT to supported units and has a specified command and control relationship and a concept of employment.

##### **Mission and Tasks**

The mission of the IIP is to provide IMINT support to MAGTFs and other commands, as directed. Specific IIP tasks include—

- Exploiting and analyzing all-source, multisensor imagery to derive intelligence pertaining to installations, troop dispositions, strengths, and activities of various conventional and nonconventional forces.
- Planning for and tasking multisensor platforms, including both those that are organic to and those that are external to the MAGTF.
- Conducting imagery exploitation and data management.
- Providing imagery derived products and reports to the MEF commander and other commanders.
- Conducting liaison with the Service-level intelligence center and external agencies for obtaining imagery products in support of MEF intelligence requirements.

##### **Organization**

An IIP is organic to each MEF and is subordinate to the P&A company of the intelligence battalion. Each IIP has a platoon headquarters, two tactical imagery analysis sections, and three imagery analysis teams (see fig. 3-1 on page 3-2).

In 2006, the 4th Imagery Interpretation Unit was incorporated into Company B, Intelligence Support Battalion of United States Marine Corps Forces Reserve (MARFORRES) and redesignated as an IIP. The 4th IIP is organized into one headquarters section, two tactical imagery analysis sections, and three imagery analysis teams. Reserve imagery analysts are also assigned to the AFP geospatial production detachment. During regular Reserve drills, the imagery analysts of

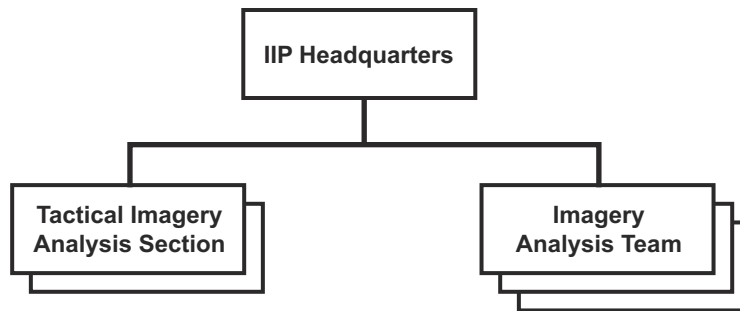

**Figure 3-1. Imagery Intelligence Platoon Structure.**

the IIP and geospatial intelligence directorate participate in federated imagery production in support of the MCIA. They also frequently perform active duty operational support to the operating forces and the national intelligence community. Reserve imagery analysts may also be mobilized as units, in teams, or as individual augments in support of operations and exercises.

### **Command and Control**

The intelligence battalion commander is in charge of command and control of the IIP, while the MEF staff has cognizance over their activities. The platoon also has other support relationships with various units.

**Intelligence Battalion Commander.** The IIP is a subordinate unit of the intelligence battalion and the intelligence battalion commander retains full command of its operations. When supporting smaller MAGTFs, the IIP (or its detachments) will operate under the command and control of either the intelligence detachment OIC or the supported unit's G-2/S-2.

**Marine Expeditionary Force Staff Cognizance.** The MEF commander exercises command and control over all intelligence battalion elements, including the IIP, via the MEF AC/S G-2 systems officer. The systems officer directs the integration of IIP operations with other MEF IMINT operations.

**Support Relationships.** The IIP operates in general support of the MEF. Under this command relationship, the MEF commander, in consultation with both the AC/S G-2 and the ISC, determines priorities for intelligence collections and production support, locations of IMINT support nodes, and the means for IMINT and all-source intelligence dissemination.

The IIP, or task-organized imagery analysis detachments, may be employed in direct support of, or attached to, a particular MSC or unit of the MEF, based upon mission, enemy, terrain and weather, troops and support available-time available (METT-T) considerations. In these cases the scope of the supported commander's C2 authority over assigned IIP elements will be specified to ensure effective support to operations while allowing the MEF commander to maintain effective command and control of broader intelligence and IMINT operations. Direct support or attachment relationships may consist of dedicated imagery exploitation support, placement of IIP assets with the supported unit, or simply establishing an IMINT node at the supported unit to provide direct dissemination of imagery and IMINT to the intelligence section or COC. In the latter of these relationships, an IIP liaison element should be provided to the supported unit. Generally,

continuing relationships between IMINT elements and supported units should be established whenever possible.

### **Concept of Employment**

An IIP supports each MEF. Task-organized imagery analysis detachments may be attached to MAGTF command elements, either independently or as part of a larger intelligence battalion detachment, when supporting a Marine expeditionary brigade, Marine expeditionary unit (MEU), or other special purpose MAGTF, as the mission requires.

The Reserve IIP conducts peacetime training and production activities in garrison at Buckley Air National Guard Base, Aurora, Colorado. The IIP and geospatial intelligence directorate of the AFP participate in federated imagery production in support of MARFORRES units, the MCIA, or the CCMDs during regularly scheduled reserve drill periods. The Reserve IIP also provides services and task-organized detachments of intelligence personnel to augment active component elements, joint commands, and national agencies in peacetime, times of crisis, contingency, or war.

The Marine imagery analysis specialists' primary imagery exploitation system is the tactical exploitation group (TEG) (see fig. 3-2 on page 3-4). The modular and scalable TEG employs commercial off-the-shelf, government off-the-shelf, and nondevelopmental item computer hardware and software to enable rapid upgrades and maintain commonality and interoperability with other Marine Corps and joint intelligence and imagery systems. The TEG provides the MAGTF commander with an organic capability to produce IMINT products in support of all operations. The TEG provides the capability to data-link imagery from theater and tactical assets as well as resourcing repositories via classified networks to support tailored imagery analysis. The TEG also disseminates imagery products and imagery exploitation reports to the MAGTF commander and subordinate commanders in support of tactical operations, strike planning, detection and location of targets of opportunity, and combat damage assessment for restrike planning and intelligence assessment. Anticipated upgrades will enable the processing of imagery from additional manned and unmanned platforms, improve video capture and exploitation capabilities, enhance net-centric functionality, and increase modularity. The TEG has two echelon-tailored configurations: virtual imagery processing-Marine Corps (VIP-MC) and tactical exploitation group-remote workstation (TEG-RWS).

The VIP-MC is the IMINT ground station for the MEF. Each IIP in the operating force has one VIP-MC; there is no VIP-MC dedicated to MARFORRES. The TEG-RWS is the deployable IMINT workstation for deploying units of the MEF. Imagery analysts of intelligence support battalion, MARFORRES maintain a limited deployable TEG-RWS capability.

### **Miscellaneous**

Other miscellaneous items relating to IIP's operations are communications and information systems and the maintenance concept for their equipment.

**Communications and Information Systems.** The IIP requires a significant amount of communication resources to support internal and detachment C2 requirements. Additionally, the IIP needs access to various classified networks to conduct its operations.

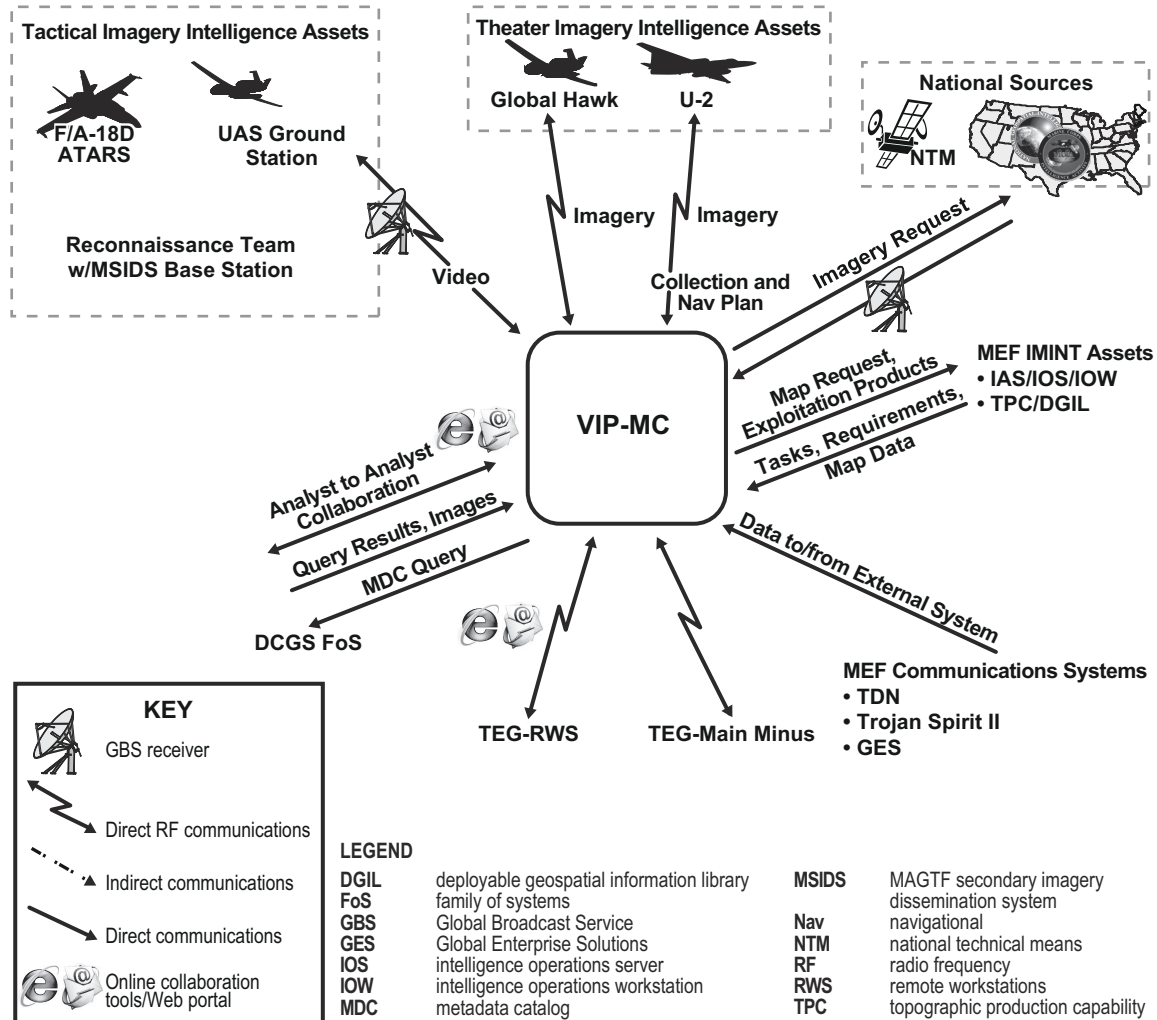

Figure 3-2. Virtual Imagery Processing-Marine Corps.

**Maintenance Concept.** The chosen product support strategy is to use contractor logistics support (CLS) supply chain management and field support representatives (FSRs) and to use the lead systems integrator (LSI) to track warranties, establish maintenance contracts, and provide software support solutions as well as to perform technology refreshes.

The TEG family of systems (FoS) is supported by the two-level maintenance concept (field and depot) per Marine Corps Order (MCO) 4790.25, *Ground Equipment Maintenance Program*. Tactical exploitation group FoS field level maintenance is performed using standard Marine Corps operating procedures and organic personnel. The Marine-performed maintenance is supported by program manager office-shared FSRs that are currently supporting the fielded TEG-RWS via a LSI contract. Equipment requiring depot level maintenance is evacuated to CLS personnel. Depot level software maintenance is performed by the LSIs. Depot level hardware maintenance is performed by the original equipment manufacturer.

With respect to unit-level maintenance, each intelligence battalion is responsible for organizational-level preventive maintenance on the TEG FoS and all associated organic Marine Corps equipment based on the unit’s table of organization.

The MARCORSYSCOM TEG program office is responsible for the budgeting and funding of the CLS contract for the entire life cycle of the TEG FoS. The TEG FoS is supported by the two-level maintenance concept (field and depot) per MCO 4790.25, *Ground Equipment Maintenance Program*.

Regarding transportation, the intelligence battalion has limited organic rolling stock to support IIP operations. External transportation support from the Marine expeditionary force headquarters groups, the MLG/supported unit is needed to move all parts of the IIP simultaneously.

---

## **TACTICAL ANALYSIS AND COMBAT TRACKING EXPLOITATION TEAM, INTELLIGENCE BATTALION**

The tactical analysis and combat tracking exploitation (TACTEX) team is responsible for certain missions and tasks. It is organized to provide the moving target indicator (MTI) capability to supported units, has a specified C2 relationship, and has its own concept of employment. The duties of the TACTEX team may be performed by an imagery analysis specialist (military occupational specialty [MOS] 0241) or by an intelligence analyst (MOS 0231). An MTI is a graphical representation of moving objects on the Earth's surface. These objects are detected by radar through Doppler shift. The radar detects moving vehicles, surface vessels, rotating antennas, slow-moving aircraft, and smaller targets (such as personnel).

### **Mission and Tasks**

The TACTEX team provides the MEF with near real time (NRT) and forensic access in order to receive, process, exploit, and analyze multiple levels of MTI, fixed target indicator (FTI), SAR imagery, high range resolution data, UAS video data, and SIGINT/communications intelligence data via the integrated broadcast service from any MTI collection platforms. Specific TACTEX tasks, performed by MOS(s) 0241 and 0231 include—

- Receiving, processing, manipulating, storing, and displaying NRT MTI, FTI, and SAR data from MTI sensors simultaneously.
- Disseminating MTI data and textual analysis to the MEF AC/S G-2, other elements of the MEF, and other forces, as directed.
- Assisting with the planning and directing of MTI collection operations in support of the MEF.
- Retrieval of historical MTI data from local databases or mission archive services to conduct forensics analysis. An MTI forensics analysis involves analyzing MTI data within specified parameters (time, location, size, speed) that is correlated with other intelligence data to add context and meaning, and produce actionable intelligence.
- Providing the capability to communicate, via voice and/or digital link, with a variety of the MTI platforms, including but not limited to the E-8 Joint Surveillance Target Attack Radar System (JSTARS), the P3 Orion Littoral Surveillance Radar System (LSRS), the Sentinel's Airborne Standoff Radar, the Sea King Mk7 Airborne Surveillance and Control helicopter, and the vehicle dismount and exploitation radar (VADER) platform.

## Organization

A TACTEX team is organic to each MEF and is currently located at the corresponding intelligence battalion. Cell structures within the battalions vary. For example, the 1st Intelligence Battalion maintains its cell under collections and the 2d Intelligence Battalion maintains its cell under the IIP. Regardless of the cell structures, however, teams will be moved to the battlefield surveillance company when they are formed, in accordance with the MCISR-E roadmap.

Each MEF has one JSTARS antenna suite (JAS) (comprised of a transit cased surveillance control data link [SCDL] ground data terminal [GDT] and SATCOM suite) and tactical exploitation group–remote workstations (TEG-RWS) variant integrated with the VANTAGE™ Ascent Software (VAS) and MOVINT Client (MC) exploitation software. Together the JAS and TEG-RWS, form the Moving Target Indicator Operation Suite (MTI OS). The MTI OS will be used to source all MAGTF MTI analysis requirements.

## Command and Control

The TACTEX team operates in general support of the MEF. The intelligence battalion commander, as the ISC, retains full control of TACTEX team activities. The MEF commander exercises command and control over intelligence battalion elements via the MAGTF intelligence officer, including the TACTEX MTI OS, which is a scalable, expeditionary/rapid-deployment capability.

## Concept of Employment

The majority of MTI platforms are national assets that support either a JTF joint force land component commander or a ground component commander under the overall direction of the JFC.

Once the TACTEX team receives data at the MTI OS from the MTI collection platform, the MTI analyst develops a report and/or MTI product that can be disseminated throughout the MEF according to the intelligence reporting criteria directed by the MAGTF intelligence officer. Under routine conditions, these data are disseminated to the P&A cell for follow-on analysis and fusion with other intelligence data to produce all-source intelligence products.

The METT-T factors may require that E-8C data be provided to other elements of the MEF and subject data be disseminated to subordinate units via the MEF tactical data network (TDN). The MTI/FTI/SAR image, with its associated data, will be viewed by recipients (potentially down to and including the regimental/group level) using common Marine Corps hardware and software suites.

**Equipment.** The TACTEX team's equipment is discussed in the following subparagraphs.

*Moving Target Indicator Operation Suite (MTI OS).* The MTI OS consists of the JAS and any TEG-RWS variant. The JAS contains a transit cased SCDL GDT, SCDL Masthead and supplementary gear, and the SATCOM Suite, comprised of a PSC-5D SATCOM radio, ancillary gear and antennas. The JAS provides a direct data link to the JSTARS E-8C for receipt of near-real-time (NRT) MTI data, fixed target indicators (FTI) and SAR imagery.

When connected to the SIPRNET, the MTI OS can access MTI from other MTI collection platform ground stations and online MTI databases such as mission archive services and

real-time dissemination and online transmission services. The mission archive services is a Web-accessible environment that provides a data enterprise to store, retrieve, and share archived MTI data and related information. Real-time dissemination and online transmission services' primary function is to provide dissemination of current MTI data.

Each TEG-RWS variant has the VAS and MC exploitation software. The VAS has a JSTARS interface, where the MTI operator can configure the SCDL and SATCOM suite hardware, and submit radar service requests and exchange free text messages. The MC is used to exploit the MTI and fuse the MTI data with other intelligence products.

*Intelligence, Surveillance, and Reconnaissance Forensic Analysis System.* The ISR Forensic Analysis Systems are Windows-based operating systems capable of providing NRT support to the MTI effort by means of SECRET Internet Protocol Router Network (SIPRNET)-data streaming. These systems are also optimal for providing detailed forensic analysis of historical data. Though not limited strictly to these functions, forensic analysis missions generally focus on studies of the following types: line of communications (LOC), traffic pattern analysis, counter-improvised explosive device backtrackings, high-value individual and high-value target, pattern of life, border crossing, littoral and maritime, cache site, traffic density, and density plot and analysis. Intelligence, surveillance, and reconnaissance forensic analysis systems are not organic program of record assets to a TACTEX team and, as a result, must be maintained as additional/supplemental CIS resources provided internally by the MEF communication battalions.

### **Miscellaneous**

Miscellaneous issues that affect TACTEX units are communications and information systems, maintenance, and transportation issues.

***Communications and Information Systems.*** The MTI OS has no organic communication resources, but when communications and information systems (CIS) resources are made available the MTI operator can support internal command and control, operations, and intelligence requirements, as well as external communications with MTI platforms and ground stations. Typically, the MTI OS will require access to the SIPRNET and pertinent local area networks (LANs) and wide-area networks (WANs). The TACTEX team members can operate all organic CIS equipment; however, all CIS resources must be provided by the MEF communications battalion.

***Maintenance.*** As part of the TEG FoS, the MTI OS is supported by the two-level maintenance concept (field and depot) per MCO 4790.25, *Ground Equipment Maintenance Program*. The TEG FoS field level maintenance is performed using standard Marine Corps operating procedures and organic personnel. The Marine-performed maintenance is supported by program manager office-shared FSRs that are currently supporting the fielded TEG-RWS via an LSI contract. Equipment requiring depot level maintenance is evacuated to CLS personnel. Depot level software maintenance is performed by the LSIs. Depot level hardware maintenance is performed by the original equipment manufacturer.

***Transportation.*** The TACTEX team has sufficient resources to displace all MTI OS equipment. Additional support will be needed from the MEF headquarters group or the MLG to displace common ground station and joint Services workstation personnel simultaneously.

---

## MARINE UNMANNED AERIAL VEHICLE SQUADRON

The VMU is responsible for certain missions and tasks. It is organized to support the MEF, has a specified command and control relationship, and a concept of employment.

### Mission and Tasks

The mission of the VMU is to operate and maintain UASs that support the MEF/other supported units. Specific VMU tasks include the following:

- Conducting aerial reconnaissance (including imagery collection and reporting), surveillance (including airborne surveillance of designated target areas, MEF or other areas of interest, and other areas, as directed), and target acquisition.
- Conducting airborne surveillance for search and rescue and tactical recovery of aircraft and personnel.
- Conducting reconnaissance of helicopter approach and retirement lanes in supporting vertical assaults.
- Providing real-time target information to the direct air support center (DASC) and fire support coordination center(s) (FSCCs) to facilitate adjusting fire missions and close air support.
- Providing real-time intelligence reporting to the SARC to support MEF intelligence requirements and to facilitate all-source intelligence operations.
- Providing information to assist adjusting indirect-fire weapons and to support and facilitate direct air support and air interdiction operations.
- Providing remote receive capability and liaison to designated units.
- Collecting information to support BDA and combat assessment.
- Supporting rear area security.

### Organization

The VMU has an external and an internal organization.

**External Organization.** The VMU is organic to the MAW and is structured to operate as a subordinate unit of one of the Marine air control groups (MACGs).

**Internal Organization.** Each of the three active component VMUs can be organized into 12 self-contained detachments: three RQ-7B SHADOW UAS suites and nine RQ-21A BLACKJACK UAS suites. Each detachment can operate and maintain one UAS suite. The RQ-7B SHADOW UAS suite is comprised of four air vehicles, two ground control stations, one launcher, and associated recovery gear. The RQ-21A BLACKJACK UAS suite is comprised of five air vehicles, two ground control stations, one launcher, and one recover device.

### Command and Control

The VMU is under the command of the MAW commanding general or the aviation combat element (ACE) MAGTF commander (when deployed in support of MAGTFs smaller than a MEF). The supported commander exercises command and control via the ACE G-3/S-3 and the Marine air command and control system (MACCS) (see Marine Corps Warfighting



Publication [MCWP] 3-25, *Control of Aircraft and Missiles*). Air operations (e.g., flight tasking, airspace deconfliction) are planned, coordinated, and controlled by the ACE G-3/S-3 via the Marine tactical air command center (TACC). However, intelligence missions are tasked per the intelligence and reconnaissance mission requirements designated by the MEF or supported unit commander; this action requires close coordination between the intelligence battalion IOC and the MAW Marine TACC.

Normally, a VMU operates in general support of a MEF. The MEF commander, through the AC/S G-2, determines VMU intelligence priorities and information and intelligence dissemination flow when the VMU is operating in the general support role. The AC/S G-2 will exercise staff cognizance of VMU intelligence operations via the ISC.

Marine unmanned aerial vehicle squadron missions may be flown in direct support of particular MEF units or MSCs (e.g., the Marine division or its main effort). In these cases, the scope of the supported commander's C2 authority over VMU missions should be specified to ensure effective support to the operations while allowing the MAGTF commander to maintain effective command and control of broader intelligence and IMINT operations. Direct support missions may require that dedicated command and control, planning, and exploitation be provided to the supported unit via a VMU detachment.

### **Concept of Employment**

A VMU can support any size MAGTF; however, normal employment would be as an integral unit of the MAGTF's ACE. The VMU can also conduct limited independent operations.

The VMU's intelligence section consists of 2 officers, 10 intelligence specialists (MOS 0231), and 38 imagery analysis specialists (MOS 0241). The intelligence section is responsible for planning collections, collecting IMINT, producing and disseminating imagery reports, imagery products, and all-source intelligence analysis.

The VMU can conduct limited imagery exploitation/analysis. Generally, UAS imagery is screened by VMU imagery analysts for information of immediate tactical value per the intelligence collection and reporting criteria stipulated by the ISC or the supported unit's intelligence officer. In most cases, the information and imagery products are sent directly to the supported unit. Imagery is also disseminated by VMU to the IIP for further detailed imagery analysis and all-source intelligence production. The MAGTF intelligence officer is responsible for subsequent IMINT dissemination, including secondary imagery dissemination.

### **Miscellaneous**

The miscellaneous issues that affect the VMU are communications and information systems, maintenance, and equipment.

**Communications and Information Systems.** Each VMU has sufficient CIS resources, which include those associated with the MACCS, to support internal and squadron command and control, operations, and intelligence requirements. The VMU normally needs access to Nonsecure Internet Protocol Router Network (NIPRNET), SIPRNET, and pertinent LANs and WANs.

**Maintenance.** Each VMU can perform organizational maintenance on its aviation equipment. The squadron can also perform first echelon maintenance on assigned ground equipment, including motor transport, engineering, and communications equipment. The MLG or supporting combat logistics battalion performs third and fourth echelon maintenance on ground equipment.

**Equipment.** See appendix G for VMU equipment and performance characteristics.

---

## MARINE FIGHTER/ATTACK (ALL-WEATHER) SQUADRON

### Mission and Tasks

The mission of the VMFA(AW) is to attack and destroy surface targets, day or night, under adverse weather conditions; conduct multisensor imagery reconnaissance; provide supporting arms coordination; and intercept and destroy enemy aircraft under all weather conditions. Specific VMFA(AW) tasks include the following:

- Conducting airborne surveillance for search and rescue and the tactical recovery of aircraft and personnel.
- Conducting day and night close air support under all weather conditions.
- Conducting day and night deep air support under adverse weather conditions (e.g., armed reconnaissance, radar search and attack, air interdiction, and strikes against enemy installations) using all weapons that are compatible with the aircraft.
- Conducting multisensor imagery reconnaissance (e.g., pre-strike and post-strike target damage assessment and visual reconnaissance).
- Conducting day and night supporting arms coordination (e.g., forward air control, tactical air coordination, and artillery/naval gunfire spotting).
- Intercepting and destroying enemy aircraft in conjunction with ground and airborne fighter direction.
- Conducting battlespace and target illumination.
- Conducting armed escorts of friendly aircraft.
- Conducting the suppression of enemy air defense operations.

### Organization

There are five F/A-18D VMFA(AW)s in the operating forces. Each squadron has 12 aircraft; only three to four aircraft are configured with the advanced tactical airborne reconnaissance system (ATARS) at any one time. The VMFA(AW) normally functions as a unit: it is structured to operate as a subordinate unit of a Marine aircraft group in support of the MAGTF. Key squadron intelligence personnel include the S-2, two all-source intelligence analysts, and four imagery analysts.

### **Command and Control**

Each VMFA(AW) falls under the command of its parent group commander. Overall, depending on the configuration of the MAGTF, operational control rests with the MAW or ACE commander. The commander exercises command and control via the ACE G-3/S-3 and the MACCS (see MCWP 3-25 for more information). Air operations (e.g., flight tasking, airspace deconfliction) are planned, coordinated, and controlled by the G-3/S-3 via the Marine TACC. However, intelligence missions are conducted according to the mission requirements designated by the MAGTF or supported unit commander and require close coordination among the intelligence battalion IOC, the Marine TACC, and supported commanders.

Marine fighter/attack (all weather) squadrons typically operate in support of the MAGTF as assigned in the ATO. However, their VMFA(AW) missions may be in direct support of a particular unit of the MAGTF (i.e., ground component, the ACE, or logistics combat element [LCE]) based on METT-T considerations. The ATO will identify these missions, pertinent command and control, and intelligence operations direction.

### **Concept of Employment**

The VMFA(AW)'s concept of employment should be considered in terms of operations and intelligence. When viewed in operational terms, the VMFA(AW) is normally employed as a unit of an ACE in support of MAGTF operations. With respect to intelligence, the VMFA(AW), when equipped with ATARS and tasked to conduct imagery collection missions, coordinates operations closely with the IOC, the MAW AC/S G-2, the IIP, and others as appropriate.

The processing of ATARS imagery is completed on the VMFA(AW), utilizing the TEG-RWS. Each VMFA(AW) is equipped with a TEG-RWS and has the capability to exploit and produce imagery as well as IMINT products and reports in support of requirements. The ATARS imagery is screened by VMFA(AW) imagery analysts for information of immediate tactical value according to intelligence collection and reporting criteria. Exploited imagery from the VMFA(AW) may be hosted on a designated imagery server. Each VMFA(AW) can conduct limited imagery exploitation or analysis. Each VMFA(AW) is interoperable with the VIP-MC, providing NRT downlinking of selected images; the remaining imagery data will be processed with the TEG-RWS. It may also be disseminated to the IIP for additional imagery exploitation support. Figure 3-3, on page 3-12, provides an overview of VMFA(AW) ATARS imagery processing flow.

### **Miscellaneous**

Each VMFA(AW) has sufficient CIS resources to support internal and squadron command and control, operations, and intelligence requirements. The VMFA(AW) needs access to various networks to conduct its operations, including NIPRNET and SIPRNET as well as other pertinent LANs and WANs.

The VMFA(AW) can conduct first echelon maintenance on all assigned equipment. It can also perform organizational maintenance on assigned aircraft and support equipment. Maintenance requirements that exceed these capabilities are provided by other ACEs and LCEs.

Each VMFA(AW) can fulfill its own particular administrative requirements.

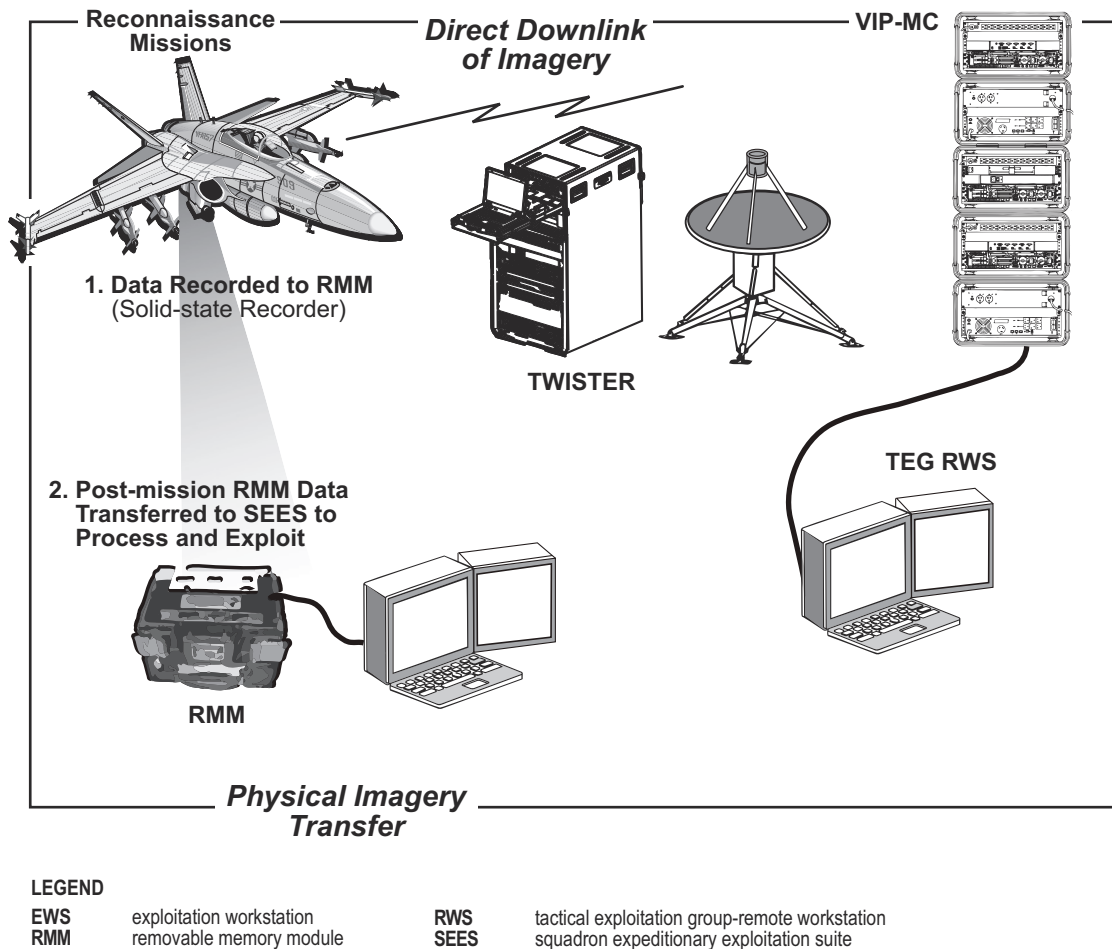

**Figure 3-3. An F/A-18 Advanced Tactical Airborne Reconnaissance System Tactical Reconnaissance Imagery Processing Flow.**

## GROUND RECONNAISSANCE

### Mission

The force reconnaissance company and the division reconnaissance battalion provide amphibious, deep ground, and ground reconnaissance; surveillance; battlespace shaping; and limited-scale raids in support of the Marine division, its subordinate elements, the MEF, other MAGTFs, or a joint force. The IMINT capability fielded to these units is the MAGTF secondary imagery dissemination system (SIDS).

### Organization

There are three Active Component and one Reserve Component reconnaissance battalions. A standard reconnaissance platoon within a battalion consists of a headquarters section and three six-man reconnaissance teams.

### **Command and Control**

The force reconnaissance company and the division reconnaissance battalion are under the operational control of the supported unit's commander. For intelligence and reconnaissance missions, the commander exercises command and control over ground reconnaissance via the unit's intelligence officer. At the MEF level, the AC/S G-2 exercises this staff cognizance via the ISC. This structure allows for the centralized direction and effective integration of ground reconnaissance operations with the broader all-source intelligence CONOPS.

Ground reconnaissance units normally operate in a general support relationship to supported units. Depending upon tactical considerations, ground reconnaissance units may be employed in direct support of, or attached to, particular subordinate units (e.g., force reconnaissance teams attached to advance force elements for an expeditionary operation; division reconnaissance battalion's platoons; or teams attached to, or in direct support of, the division's main effort). To ensure effective support to the operations while allowing the MEF or division commander to maintain effective command and control of broader intelligence and reconnaissance operations, the scope of the supported commander's C2 authority over designated ground reconnaissance teams is usually specified.

### **Concept of Employment**

The force reconnaissance company normally operates under the staff cognizance of the MAGTF G-2/S-2 for reconnaissance and surveillance missions and under the staff cognizance of the MAGTF G-3/S-3 for offensive missions. The basic operating unit is the team; however, platoons or task-organized elements may be employed to accomplish certain tasks.

Force reconnaissance operations should have a defined scope and duration, with planned exfiltration. Teams are usually inserted into the supported commander's area of interest (AOI) (usually the deep area), often well beyond the supporting arms and reserve elements of the enemy's committed forces, in order to collect and report information in response to the commander's PIRs.

When required by the situation, the company or detachments may be placed in direct support of, or attached to, smaller MAGTFs or to MEF elements other than the command element. Normally, a force reconnaissance detachment is attached to a MEU.

Because force reconnaissance company units routinely operate beyond the range of the MAGTF's supporting arms, the company must maintain the capability to clandestinely insert and extract units over extended distances. Such means include foot movement, surface or subsurface swimming, vehicles, rotary- or fixed-wing aircraft, small boats, landing craft, and commercial assets. All teams are capable of using closed-circuit underwater breathing apparatuses, open-circuit SCUBAs [self-contained underwater breathing apparatuses], and submarine lock-outs. Also, all teams are capable of static-line and military free-fall parachuting.

Deployed teams use standard techniques of small-unit scouting and individual movement. Unless the mission requires otherwise, force reconnaissance teams will avoid contact with the enemy or indigenous people. Teams either observe from vantage points or physically reconnoiter the AOIs. As directed, teams report by radio and/or during post mission debriefings. When conducting offensive operations, force reconnaissance company elements employ the previously described

techniques to reach their objective sites. Conducting actions at the objective area, they employ close-quarter battle, standard tactical assault, or sniper techniques to neutralize or destroy enemy targets and/or to recover designated personnel or materiel.

Teams assigned to initial terminal guidance missions reconnoiter the landing area and provide last-minute visual or electronic terminal guidance to flight, wave, or stick leaders. Initial terminal guidance missions terminate with the arrival of the helicopter support team, US Navy beach party, landing craft air cushion LZ control teams, US Army Pathfinder teams, or US Air Force combat control teams, which then assume traffic-control functions.

---

# CHAPTER 4

## IMAGERY INTELLIGENCE SYSTEMS, C2 NODES, CIS, AND OTHER SYSTEMS

This chapter addresses the major MAGTF IMINT C2 and CIS nodes from a systems perspective and describes the impacts of processing, exploitation, and dissemination on these nodes.

---

### BASIC IMAGERY INTELLIGENCE COMMUNICATIONS AND INFORMATION SYSTEMS REQUIREMENTS

#### **Managing Subordinate Imagery Intelligence Units**

Intelligence officers and IMINT element OICs must maintain positive command and control of subordinate units and integrate their operations with broader MAGTF and external intelligence and operational command and control. Traditionally, single-channel radio and recorded message traffic has been used to support command and control of MAGTF IMINT elements. In semi-static situations, secure e-mail or telephone may be the method of choice for communicating; whereas, in highly fluid or mobile scenarios, cellular telephones, SATCOM, and radio may be used.

#### **Receiving Data and Information From Organic/External Imagery Intelligence Organizations**

Communication and information systems architecture must provide connectivity between organic and supporting IMINT elements, IMINT production and analysis centers, and supported MAGTF operations and intelligence centers. Requirements include the ability to transmit images and related data files and IMINT reports digitally via fiber optics, wire/radio in both voice and data formats that are readily usable by imagery and all-source intelligence analysts.

#### **Providing Intelligence to Supported Commanders**

Imagery intelligence CIS requirements are influenced by the supported commanders' intent, CONOPS and intelligence, command relationships, and standing PIRs and intelligence requirements. Communication and information systems architecture must be capable of integrating IMINT element command and control and supporting CIS operations with the primary CIS channels used by the supported commanders.

#### **Providing Imagery Intelligence Products and Reports to National Intelligence Centers, Theater, Joint Task Force, MAGTF, and Other Components**

Imagery intelligence products are provided to designated organizations via the MAGTF's organic secured/nonsecured communications networks.

---

## IMAGERY INTELLIGENCE AND RELATED COMMAND AND CONTROL NODES

The national nodes for imagery intelligence, NST, and NRO were discussed in chapter 2.

Within a theater, there are different levels of nodes, such as the combatant commander JIOC, the JTF J-2, and the JISE.

### **Combatant Commander Joint Intelligence Operation Center**

The combatant commander, JIOC is responsible for fulfilling the intelligence requirements of both the combatant commander and his subordinate commanders. By providing finished intelligence products supporting theater mission planning and execution, the JIOCs are the primary sources from which subordinate JTFs receive intelligence support for their AOI.

**Collection.** Combatant commander J-2s retain full collection management authority over all ICRs against targets within their area of responsibility. This authority may be delegated to a subordinate JFC. Validated collection requirements that cannot be satisfied by organic means, including imagery collection, are submitted to the CCMD JIOC.

**Processing and Exploitation.** Each JIOC processes and exploits imagery in its particular theater. Downlinked imagery data signals may be transmitted to workstations for immediate exploitation/archiving.

**Production.** Combatant command and Service Intelligence Center production responsibilities are clearly delineated within the Department of Defense Intelligence Production Program (DODIPP). The DODIPP is structured to capitalize on the analytical and production resources of the entire DOD intelligence production community. The community on-line intelligence system for end-users and managers automates DODIPP procedures for stating and tracking theater intelligence requirements and other intelligence production requirements. Results from imagery exploitation and the annotated images may be incorporated into all-source intelligence products, standalone IMINT products, or into various GEOINT databases.

**Dissemination.** Dissemination of digital products is done via the DCGS-MC and the primary dissemination medium for intelligence is SIPRNET. Along with e-mail distribution, the JIOC utilizes Web sites and portals as hubs to collaborate and post finished intelligence products.

### **Joint Task Force J-2 and the Joint Intelligence Support Element**

The JTF J-2 organizational structure and capabilities are driven by the mission. Intelligence CIS, based on functionality, enables the JTF to query theater and national IMINT servers and databases for current intelligence.

The JISE is the principal intelligence C2 node within the JTF J-2 and is the focus for JTF intelligence operations, providing the JFC and component commander with situational awareness and other intelligence support regarding adversary air, ground, maritime, and space capabilities and activities. A NIST, supporting the JTF headquarters, integrates its operations within the JISE. Key JISE functions and capabilities include collection management support, OOB analysis,



identification of threat critical capabilities (i.e., critical requirements), critical vulnerabilities, and intelligence support to targeting and force protection.

All IMINT collection, production, and dissemination activities are conducted within the JISE. Once IMINT products and support have been provided to the JTF and its components, updates are delivered by the JISE using multiple dissemination techniques.

**Collection.** The JTF J-2 collection manager plans, coordinates, and employs direct imagery collection operations to support the JTF. The MAGTF interfaces with the collection assets, as is depicted in figure 3-2, on page 3-4. Communication support planning provides connectivity from these major nodes into the TEG and MAGTF TDN.

**Production.** Imagery intelligence production requirements are managed by the JISE per the JFC's PIRs and validated intelligence requirements.

**Dissemination.** Once basic and current intelligence and imagery have been provided to a deploying JTF and its components, updates will be accomplished using multiple dissemination techniques. Intelligence CIS, based on the applicable networks, provides the JTF with the ability to query theater and national IMINT servers and databases for current intelligence.

**Amphibious Task Forces.** While afloat, landing forces use the amphibious task force (ATF) imagery architecture to access/transfer GEOINT data. Once ashore, the landing force communications responsibilities transfer to its organic G-6/S-6 for communications.

**Intelligence Center.** During amphibious operations, the intelligence sections of the ATF and the landing force normally integrate their operations. The principal intelligence C2 node afloat is the intelligence center located aboard the ATF flagship. The intelligence center has installed CIS systems that support the intelligence operations of the ATF and landing force while reducing duplicative functions and producing more comprehensive and timely intelligence for the naval task force. Standard CIS connectivity is available.

### **Marine Expeditionary Force Command Element**

**Combat Intelligence Center.** The combat intelligence center (CIC) is the principal MAGTF intelligence C2 node providing the facilities and infrastructure for the centralized direction of the MEF's comprehensive intelligence, counterintelligence, and reconnaissance operations. The CIC is the primary IOC established within the MEF main command post. It encompasses the primary functions of the MEF intelligence section and intelligence battalion. The CIC includes the subordinate elements listed in table 4-1 on page 4-4.

**Table 4-1. Marine Expeditionary Force Command Element Combat Intelligence Center.**

<b>Element</b>	<b>Responsibilities</b>
<b>G-2 Plans</b>	Serves as the G-2 section's main element for coordinating and providing intelligence support to the MEF command element future plans team and leadership of the G-2 sections GEOINT, SIGINT, and METOC sections.
<b>G-2 Operations</b>	Serves as the G-2 section's main element for coordinating and providing intelligence support to the MEF commanding general, battle staff, and current operations center elements; target intelligence support to the force fires and future operations; G-2 section intelligence requirements management activities; red cell support; and MEF intelligence liaison with external commands and organizations.
<b>IOC</b>	Serves as the principal MEF intelligence operations and C2 center established by the intelligence battalion; performs intelligence requirements management, staff cognizance of ongoing organic and supporting collection operations, intelligence production and analysis, and intelligence dissemination.
<b>Support Cell</b>	Serves as the primary element for conducting MEF-wide intelligence requirements management, weather support, collections and dissemination planning and direction, and intelligence staff cognizance of MEF organic and supporting intelligence and reconnaissance operations.
<b>P&amp;A Cell</b>	Serves as the primary production and analysis element of the MEF; processes and produces all-source intelligence products in response to requirements of the MEF; serves as the principal GEOINT production element of the MEF.
<b>SARC</b>	Serves as the primary element for the supervision of MEF collection operations; directs, coordinates, and monitors intelligence collection operations conducted by organic, attached, and direct support collection assets.
<b>Counterintelligence/HUMINT Company</b>	Serves as the primary element for conducting counterintelligence/HUMINT planning and direction, C2, and coordination of MEF counterintelligence/HUMINT operations with external counterintelligence/HUMINT organizations.
<b>Operations Control and Analysis Center</b>	Serves as the main node for the command and control of radio battalion SIGINT operations and the overall coordination of MEF SIGINT operations; processes, analyzes, produces, and disseminates SIGINT-derived information; and directs the ground based electronic warfare activities of the radio battalion.
<b>Reconnaissance Operations Center</b>	Serves as the main node for the command and control of a force reconnaissance company's operations and the overall coordination of MEF ground reconnaissance operations; processes, analyzes, produces, and disseminates ground reconnaissance-derived information in support of MEF intelligence requirements.

**Intelligence Operations Center.** The IOC is the other key MEF command element intelligence node. The subordinate elements within the IOC and their typical composition are the support cell, the SARC, and the P&A cell (see fig. 4-1 on page 4-5).

**Overall Marine Expeditionary Force Intelligence C2 Relationships.** The MEF G-2 section and intelligence battalion's overall C2 relationships, along with the resulting all-source intelligence support flow throughout the MEF are depicted in figure 4-2, on page 4-6.

**Combat Intelligence Center/Intelligence Operations Center Operations and Imagery Intelligence.** Imagery intelligence is an integral component of many CIC/IOC operations. Key activities include collection, production, and dissemination.

**Collection.** The CMD section, intelligence battalion, provides the core for MEF CIC collection operations. During operations, the CMD section is located within the IOC support cell.

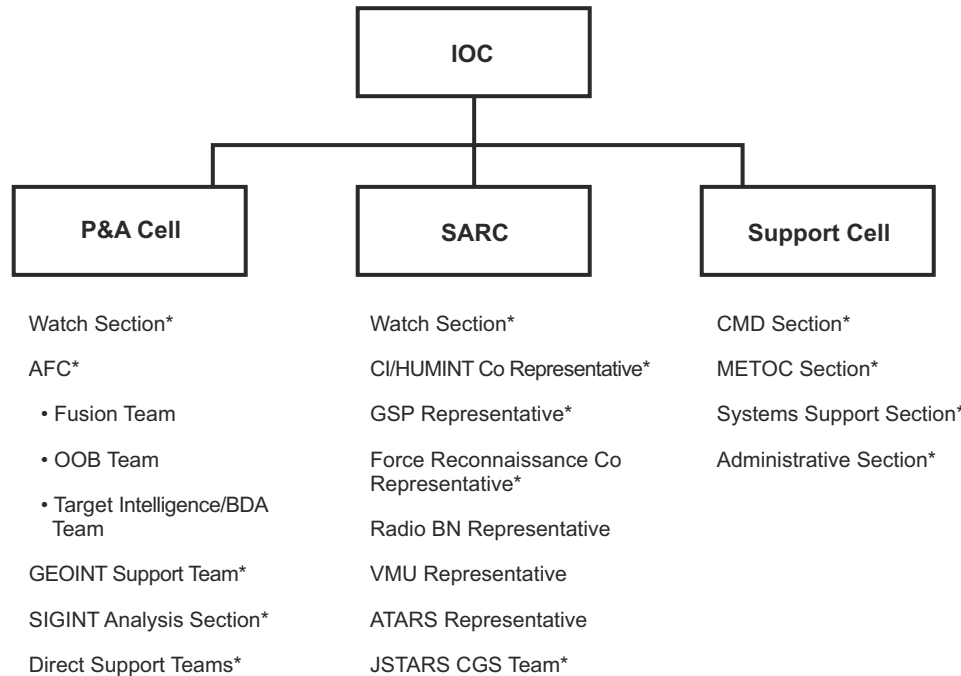

\*Personnel provided wholly or partially by intelligence BN.

**LEGEND**

<b>AFC</b>	all-source fusion center	<b>Co</b>	company
<b>BN</b>	battalion	<b>GSP</b>	ground sensor platoon
<b>CI</b>	counterintelligence		

**Figure 4-1. Intelligence Operations Center Elements and Composition.**

Intelligence specialists from all disciplines are organic to this section. Key CIS resources required include an Intelligence Analysis System (IAS), with community on-line intelligence system for end-users and managers and other specialized applications, and access to the full range of communications (e.g., JWICS, SIPRNET, NIPRNET). The SARC provides the other component of collection operations. The SARC should have representation from most organic and supporting intelligence and reconnaissance units. Imagery intelligence representation should include a VMU element with supporting CIS resources that will monitor ongoing UAS operations and report time-sensitive intelligence.

*Production.* The P&A cell, intelligence battalion, provides the core for MEF intelligence production operations. Intelligence specialists from all intelligence disciplines are organic to the P&A cell. Key CIS resources required included IAS and the joint deployable intelligence support system, with access to the full range of communications (e.g., JWICS, SIPRNET, NIPRNET). Generally, the IIP and intelligence battalion will be integrated with P&A cell operations to support both IMINT and all-source production operations.

*Dissemination.* The CMD section, intelligence battalion, provides the core command and control for MEF intelligence dissemination operations. Key CIS resources include IAS and the joint deployable intelligence support system, with access to the full range of communications (e.g., JWICS, SIPRNET, NIPRNET) for external dissemination and IAS via the TDN and other MEF

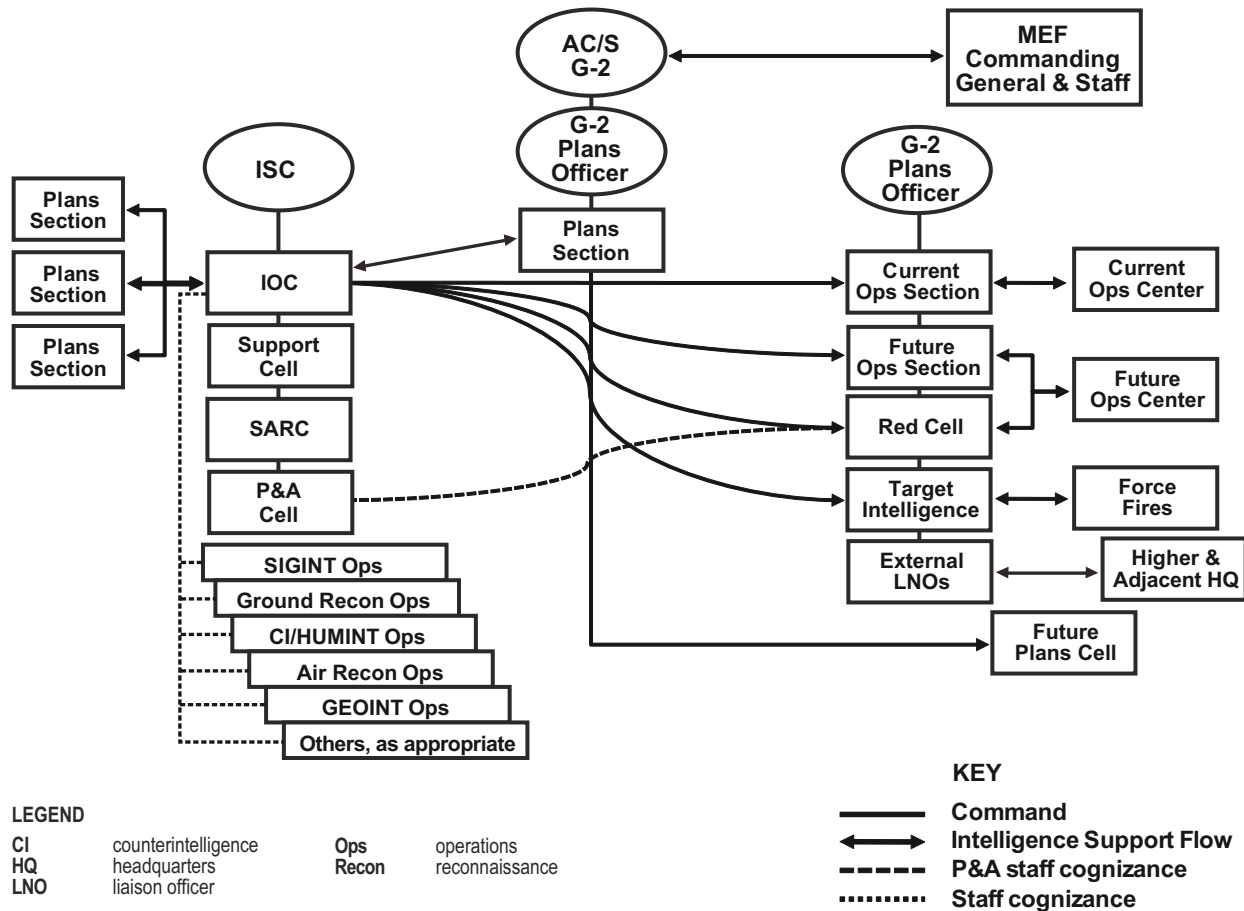

**Figure 4-2. Marine Expeditionary Force C2 Relationships and Intelligence Support Flow.**

communications resources for internal dissemination. The MEF command element should exploit all of the external capabilities to satisfy its intelligence requirements, with heavy reliance on the MCIA for national imagery support and the JIOC/joint analysis center for theater and national support.

National imagery and related products are received over dedicated terrestrial links that terminate at the MCIA’s direct feed imagery product library; standard communications connectivity from the deployed MEF to the MCIA via the Defense Information Systems Network are normally provided by satellite communications. Currently, these links are super-high frequency (X-Band) military SATCOM using ground mobile forces terminals. In the future, more C-Band and Ku-Band commercial SATCOM, using mobile Tri-Band SATCOM terminals, will be employed. The limited capacity of these links to Defense Information Systems Network are a significant chokepoint for deployed MAGTFs. Efficient use of these links is critical to maintaining high traffic throughput.

In addition to the MAGTF TDN and other common-user communications capabilities, several imagery units have specialized capabilities to support IMINT dissemination. The VMU’s remote receiving station, attached to MEF MSCs (i.e., the MEF main effort), provides direct, time-sensitive UAS support. Within the MEF, the IAS is the principal information system resource that supports secondary imagery and other IMINT product dissemination. The IAS should be available at all command echelons down to the maneuver battalion/squadron levels. Communications

connectivity between the MEF command element and its MSC headquarters are predominantly provided by SATCOM, supplemented where practical with terrestrial line-of-sight and tropospheric scatter (known as troposcatter) multichannel radio systems. Connectivity to the regiment/group level is principally via the TDN and various multichannel radio resources.

Finally, communications connectivity below the regiment/group command echelon depends on single-channel radio primarily designed for voice traffic, with limited range and limited data capacities. Although these units possess tactical data systems, their ability to exchange data is currently limited due to reduced bandwidth connectivity with the MAGTF TDN.

---

## IMAGERY INTELLIGENCE INFORMATION SYSTEMS AND SUPPORTING COMMUNICATIONS

### Imagery Direction and Collection Management

The GEOINT community uses a variety of systems to support and direct MAGTF IMINT operations. The DCGS-MC integrates surveillance and reconnaissance processing and exploitation capabilities into a single, integrated net-centric capability (see fig. 4-3, on page 4-8). Increment 1 of the DCGS-MC will integrate the TEG FoS and the topographic production capability into a common hardware/software baseline for GEOINT support.

The DCGS MC is interoperable with other distributed common ground/surface systems (DCGSs) including DCGS-Army, DCGS-Air Force, DCGS-Navy, DCGS-Special Operations Forces, and DCGS-intelligence community. The use of distributed common ground/surface system integration backbone (DIB) standards allows DCGS-MC interoperability with all other agencies that comply with those standards. These agencies include the NGA, NSA, NRO, DIA, and some allied and coalition forces, as well as the national intelligence architecture. The DCGS MC supports multidiscipline joint, national, multinational (coalition/allied) force commanders, JTF commanders, and below with critical multisource, multi-intelligence data and products to support JTF-level campaign planning and execution.

While embarked aboard amphibious shipping, MAGTF units use the DCGS MC in conjunction with DCGS-Navy assets for all ISR requirements. Once it is transitioned ashore, DCGS MC enterprise provides support to the naval forces through DCGS interoperability. The DCGS MC connects intelligence analysts to multidiscipline national, joint/multinational organic collection assets, data sources, and analytic assessments. It is the backbone of the MAGTF's ability to produce targeting information, correlate surveillance data and other intelligence, and rapidly disseminate information to MAGTF commanders in order to achieve decision superiority.

The DCGS-MC data feeds the COP. The DCGS-MC provides local data discovery and exposes designated MAGTF intelligence data, reports, and products to the DOD DCGS enterprise. The DCGS-MC can integrate sensor data from the broad range of current and planned Marine Corps tactical ISR and nontraditional ISR assets. It accommodates receipt of these data via MAGTF command and control, LANs, the Global Information Grid, and directly from intermediate systems, such as UASs via direct data link, ground control stations, or the removable memory media for ATARS imagery. The DCGS-MC has three nodes: fixed, garrison, and expeditionary.

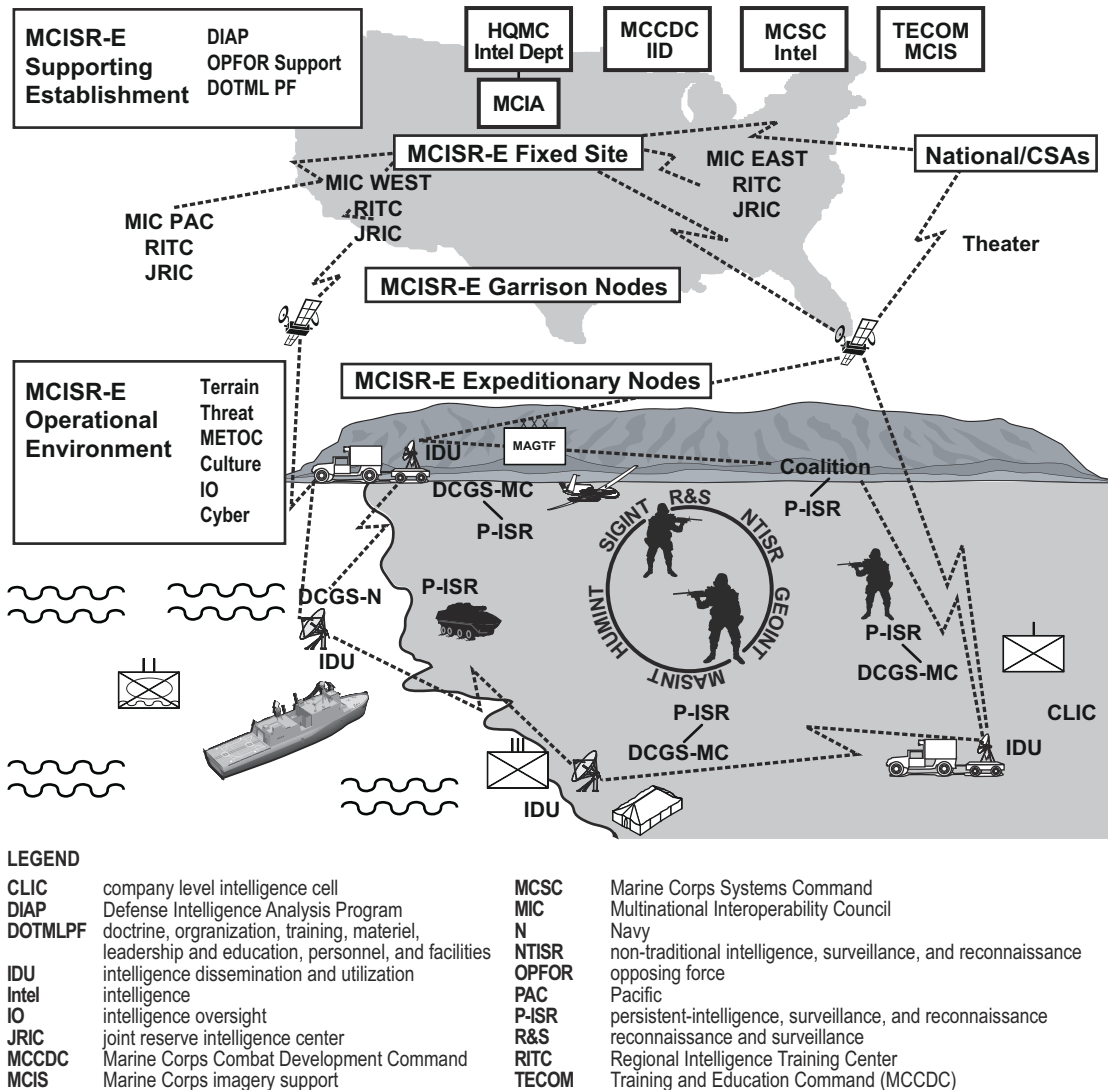

**Figure 4-3. The Marine Corps Intelligence, Surveillance, and Reconnaissance Enterprise.**

The MCISR-E fixed site node is hosted at the MCIA and supports information searching, archiving, and collaboration. The MCISR-E fixed site provides data repository services and metadata tagging services that enable a requester to access specific information, data, products, or services. The MCISR-E fixed site is the DCGS-MC exposure site for Marine Corps intelligence data and the Marine Corps metadata registry and catalog. Additionally, when bandwidth restrictions or the characteristics of combat prevent DIB exposure by a deployed MAGTF, the fixed site will serve as an entry point to MAGTF-produced information for national-level intelligence agencies and other external organizations, data, and products.

Garrison nodes, located at each MEF, provide the DCGS-MC with DIB-enabled functional capabilities (i.e., GEOINT, all-source analysis, SIGINT, MTI). They mirror the basic capabilities of expeditionary nodes and, where required, include increased capability (e.g., additional data storage). Garrison nodes can be deployed if necessary. Garrison nodes provide the MEF with the capacity to duplicate capabilities of deployed MAGTFs while serving broader remain behind MEF elements. Garrison nodes are also located at each MEF intelligence center, regional

intelligence training center, and joint reserve intelligence center. These centers provide reachback support to deployed forces, expose data to the larger DCGS enterprise, and provide a baseline intelligence capability for federated production with MCISR-E guidelines.

The expeditionary nodes are linked to the garrison and fixed site nodes. Expeditionary node equipment and capabilities can be scaled to support any size MAGTF. The primary role of the expeditionary nodes is to provide processing, exploitation, analysis, and production capabilities to deployed MAGTFs. When deployed with a MAGTF, expeditionary node capabilities will include the ability to maintain local, tactical intelligence data storage and expose MAGTF intelligence data within the MAGTF, as well as to multidiscipline joint, national, multinational partners. Due to frequent bandwidth restricted operations (i.e., aboard ship or during remote operations), the MAGTF commander retains control of the amount of information exposed directly to the larger DOD DCGS enterprise, MCISR-E garrison nodes, and the fixed site node.

### **Geospatial Intelligence Information Management Services**

Geospatial intelligence information management services provide the MAGTF and other users with a comprehensive national and commercial imagery collection management capability. As the primary tool for imagery collection needs, geospatial intelligence information management services—

- Allow MEF collection managers to generate national and commercial imagery requests, search and order simple to complex GEOINT products, visualize data, and provide mission awareness.
- Enable collection managers to compute, display, and monitor enterprise metrics.
- Task and transmit to collection, exploitation, production, and dissemination organizations the geospatial intelligence needs, formally known as nominations, which, upon validation and prioritization, are automatically transferred to the appropriate review authority.

### **Imagery Collection**

The Marine Corps relies on both organic and external collection assets for its imagery (see fig. 4-4 on page 4-10).

***F/A-18D and Advanced Tactical Airborne Reconnaissance System.*** The ATARS suites are organic to the F/A-18D squadrons (see fig. 3-3 on page 3-12). These ATARS-equipped F/A-18D aircraft provide the MAGTF with an organic manned aerial imagery reconnaissance capability in support of IMINT operations. The ATARS suites are capable of infrared, EO, and radar imagery collection, and provide high-resolution day and night imagery support in all weather conditions through both overflight and long-range standoff.

The F/A-18D's long-range standoff capability is made possible by the upgraded, all-weather SAR system. Imagery is recorded and data-linked via the ATARS sensor suite. The tactical interoperable ground data link II common data link provides a limited NRT capability for disseminating data from selected critical targets—downlinked to the IIP's TEG—with subsequent removable memory media download for the exploitation of the complete track at the squadron. Figure 4-5, on page 4-11, depicts the F/A-18D systems architecture.

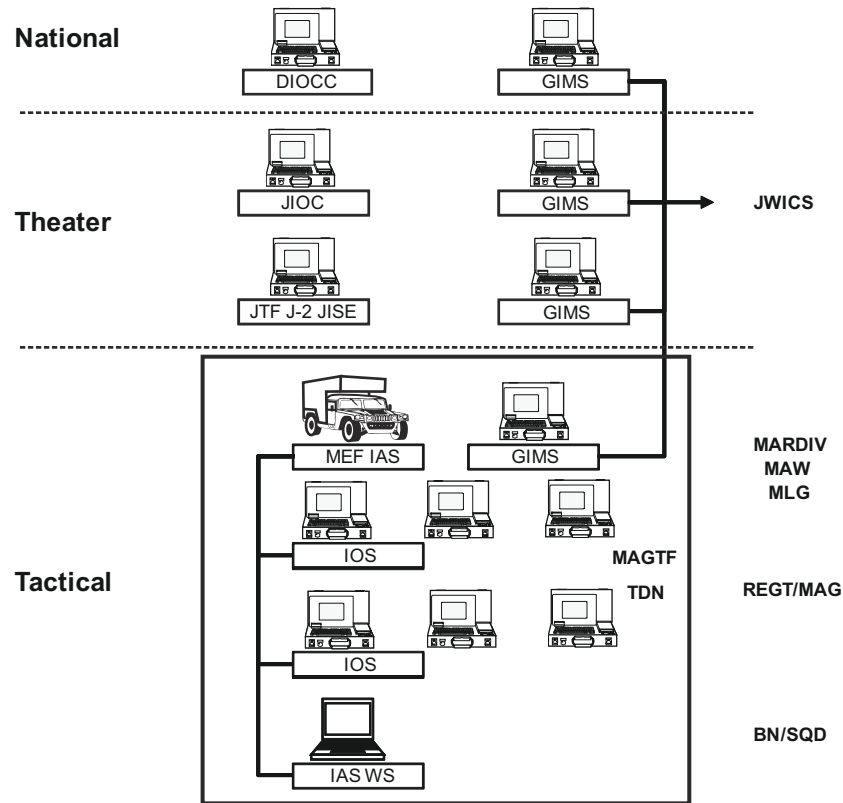

LEGEND			
BN	battalion	MAG	Marine aircraft group
DIOCC	Defense Intelligence Operations Coordination Center (DIA)	MARDIV	Marine division
GIMS	Geospatial Information Management System	REGT	regiment
IOS	intelligence operations server	SQD	squad
		WS	workstation

**Figure 4-4. MAGTF Imagery Operations.**

**Unmanned Aircraft Systems.** Full motion video feeds have been by far the most effective use of UAS. This live TV coverage of enemy actions or friendly events has contributed more to the commander’s situational awareness than any other system in the commander’s inventory. See appendix G for additional information regarding UAS equipment and performance characteristics. The following subparagraphs discuss UAS CIS resources.

**Remote Video Terminals.** Supported units can use/access FMV with a remote video terminal (RVT). The RVT is often the most practical means by which tactical users (e.g., platoon and company commanders, forward air controllers, and air officers) receive video and telemetry information.

The RVT is a ruggedized laptop computer with antenna and software that enable data processing and direct viewing of sensor imagery and telemetry information. Typically, the RVT has limited range (approximately 15 km from the UAS). Some RVTs have much larger directional antennas that can receive video from beyond 45 km. The RQ-7 Shadow is equipped with four one-system remote video transceivers. The one-system remote video transceivers can be used by supported units, such as a regimental COC, to receive video and telemetry from an RQ-7B and certain other types UASs from greater distances.



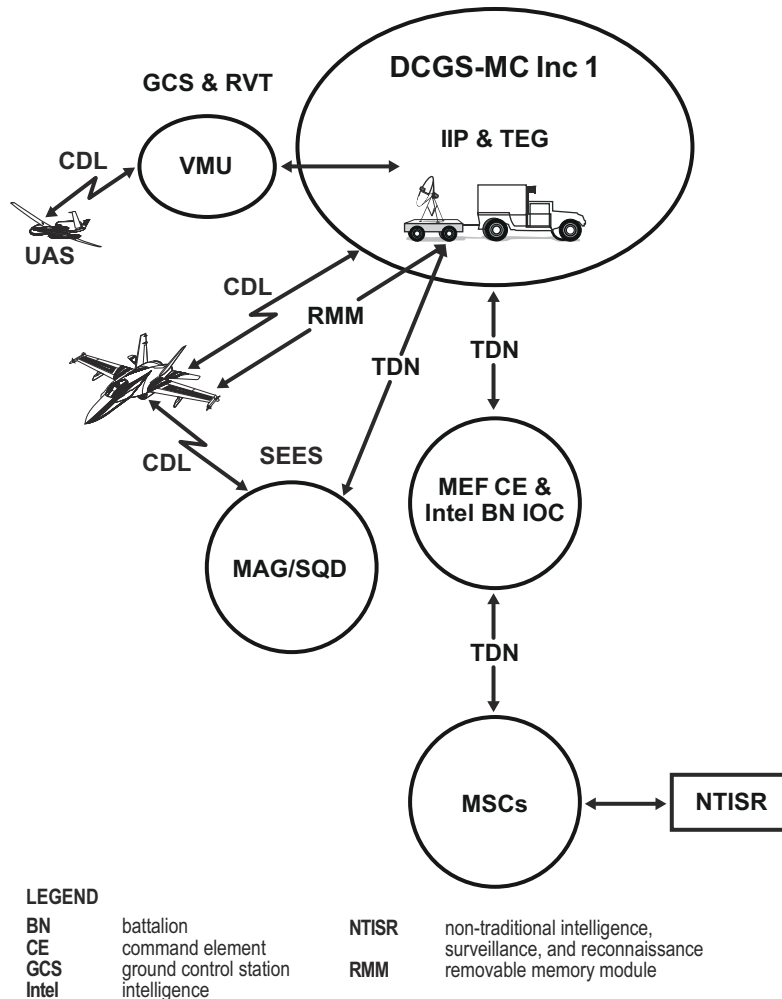

**Figure 4-5. The F/A 18D Systems Architecture.**

The primary RVT for the Marine Corps is the VideoScout system being fielded to tactical air control parties and battalion air officers. VideoScout can view video on analog or digital L, S, C, and Ku frequency bands.

*Video and Data Distribution Networks.* Video and data distribution networks provide a multilayer distribution capability that ensures multiple paths for UAS imagery and reduces latency for high priority users.

Supported units in the field can receive video and telemetry directly from the UAS using organic VideoScout or Remote Operations Video Enhanced Receiver III systems. Other units or headquarters equipped with a VideoScout and within range of the UAS can also receive the same video imagery.

For situations where a remote unit or agency desires video and telemetry data, communications architecture that can facilitate the transmission of large volumes of FMV/telemetry data need to be developed by the MAGTF G-6.

Marine UASs provide an interoperable data stream that is compliant with NATO STANAG [standardization agreements]. The data stream interfaces or plugs in to systems devised by the MAGTF G-6. The plug-in would be applied to a system integral to the unit operations center/COC. The unit operations center/COC would then provide the interface for the DCGS-MC. Consequently, all MAGTF units connected to the DCGS-MC should have access to the video/telemetry data provided by the UAS; however, the data should be at an increased level of imagery latency.

*Moving Target Indicator Operation Suite.* The MTI OS is organic to the MEF intelligence battalion. It provides the MAGTF command element with both communications connectivity with the Air Force’s JSTARS E-8C and the capability to display, process, and disseminate acquired information. Figure 4-6 depicts the MAGTF JSTARS systems architecture and CONOPS. The following are capabilities of the MTI OS:

- The MTI OS receives and processes MTI, FTI, and SAR data from the JSTARS E-8C aircraft.
- The MTI OS receives UAS video data via the SIPRNET.
- The MTI OS receives processed SIGINT from the Integrated Broadcast Service.
- The MTI OS receives secondary imagery from theater and national sources.

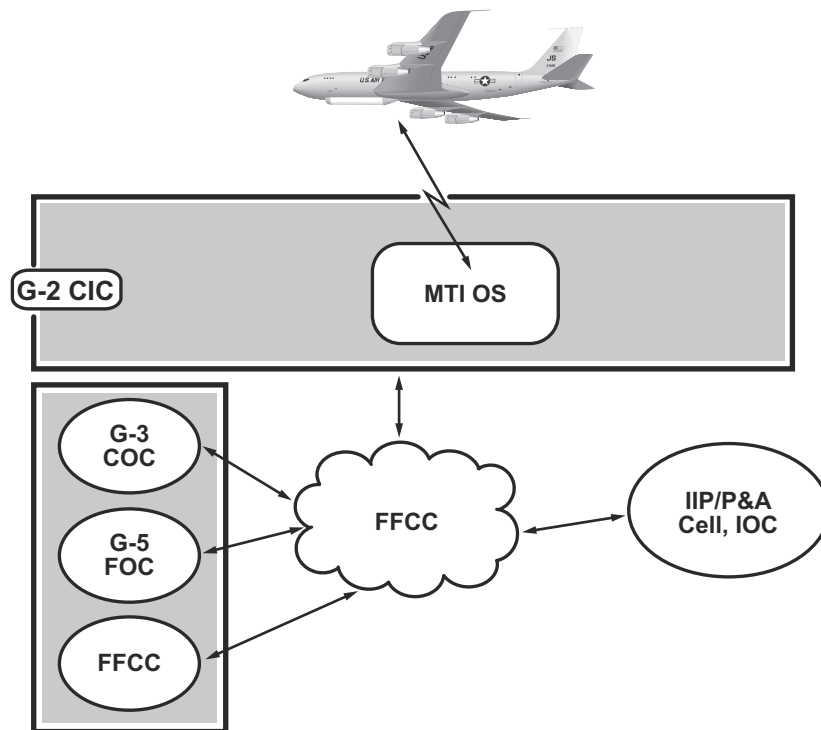

LEGEND  
 FFCC force fires coordination center  
 JSWS joint services workstation

**Figure 4-6. Joint Surveillance Target Attack Radar System Common Ground Station Systems Architecture.**

- The encrypted, highly jam-resistant SCDL provides the digital communications connectivity between the E-8C JSTARS airborne element and the MAGTF command element G-2 section's MTI OS, enabling the transmission of MTI, SAR, and FTI data acquired by JSTARS to support MAGTF target acquisition, situation development, battlespace management, and targeting functions.
- The MTI OS features an open-system architecture that enables rapid insertion of the latest government and commercial off-the-shelf technology.

*Collection Capabilities.* The E-8C carries a phased-array radar antenna in a 26-foot canoe-shaped radome under the forward part of the fuselage. With a range in excess of 155 miles, this radar covers an estimated 386,100 square miles in a single 8-hour sortie. It is capable of providing targeting and battle management data to all MTI operators, both in the aircraft and on ground. These operators prepare intelligence reports and/or help coordinate aircraft, missiles, or artillery fire support.

*Wide-Area Airborne Surveillance Sensor and Moving Target Indicator.* The wide-area airborne surveillance sensor and the MTI are the primary operating modes for the radar. They detect, locate, and identify slow-moving targets. By focusing on smaller terrain areas, the radar image can be enhanced for increased resolution display. High resolution enables analysts to identify moving targets.

*Synthetic Aperture Radar/Fixed Target Indicator.* The SAR and FTI produce a photo-like image or map of a selected geographic region. A SAR data map contains precise locations of critical nonmoving targets, such as bridges, harbors, airports, buildings, or stopped vehicles. The FTI display is available while operating in the SAR mode to identify and locate fixed targets within the SAR area. The SAR and FTI capability, used in conjunction with MTI and MTI history display, allow for post-attack assessments made by onboard or ground operators following a weapon attack on hostile targets.

*Ground Moving Target Indicator Forensics Tool.* The MTI OS has a ground MTI forensics tool, which enables it to exploit MTI imagery analysis from points of interest or to compare movement over time. Such comparison enables the development of tracks and the conduct of meaningful historical intelligence analysis. The ground MTI forensics tool gives the MTI OS workstation operators and ground MTI analysis cells the ability to exploit historical MTI imagery from multiple sources.

*MAGTF Man-Packed Secondary Imagery Dissemination System.* The MAGTF SIDS (see fig. 4-7 on page 4-14) contains multiple configurations consisting of base stations, outstations, and video exploitation workstations depending on each unit's configuration and mission requirements (e.g., MEU structure requires six outstations, three base stations, and one video exploitation workstation). The mission of MAGTF SIDS is to enable the MAGTF to capture, manipulate, annotate, and transmit imagery products in NRT both internally with subordinate commands that are widely separated throughout the AO and externally with higher and adjacent commands (see fig. 4-8 on page 4-15). The MAGTF SIDS is employed according to the doctrine TTP prescribed in doctrinal publications associated with Marine Corps operations. The MAGTF SIDS may be employed in many different scenarios worldwide in which a MAGTF is expected to operate including shipboard, garrison, or tactical environments. The MAGTF SIDS is capable of supporting all phases of operational maneuver from the sea, sustained operations ashore, and other expeditionary operations.

### Imagery Collection Data Flow

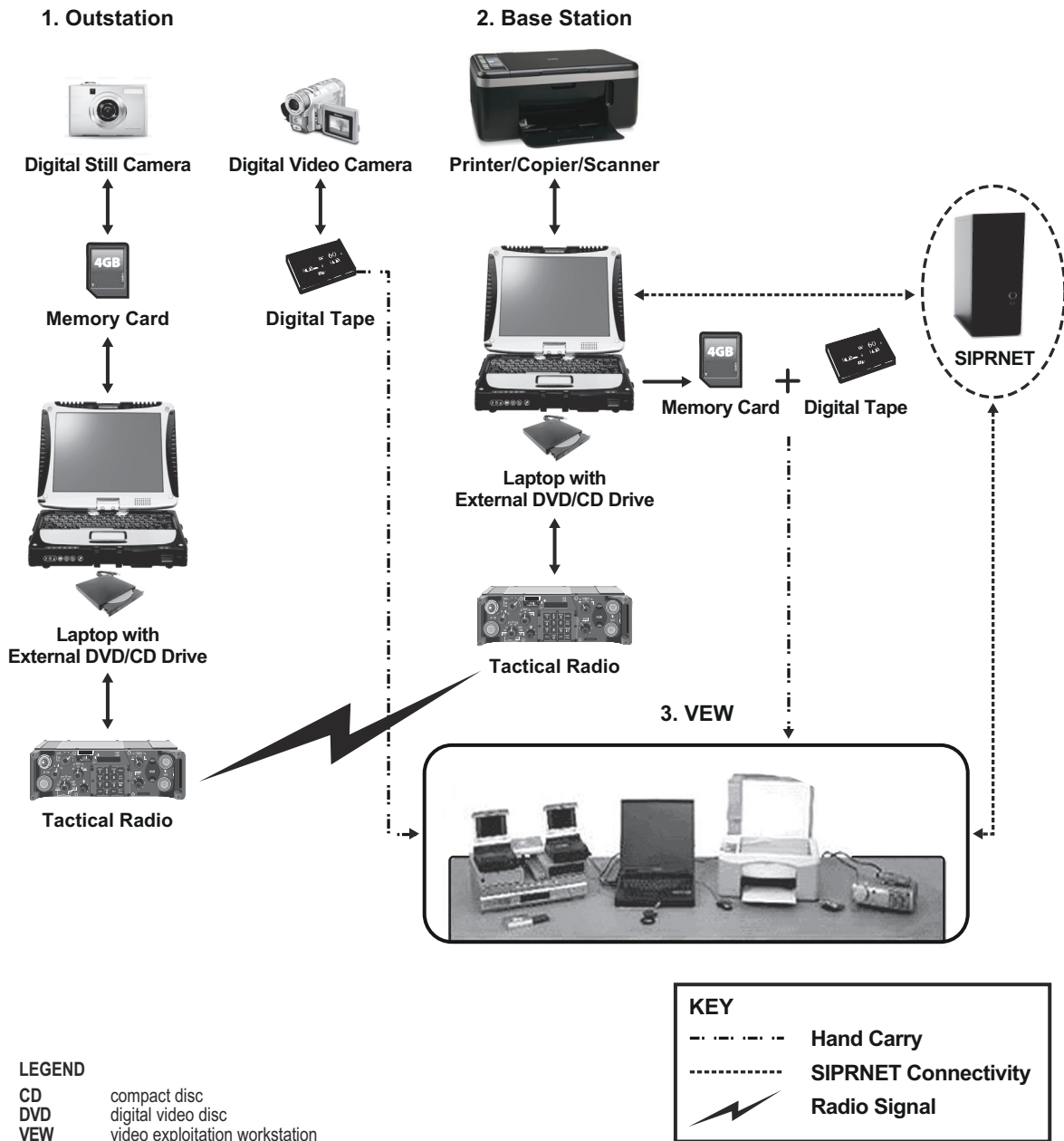

**Figure 4-7. MAGTF Secondary Imagery Dissemination System Diagram.**

*MAGTF Secondary Imagery Dissemination System Base Station.* The MAGTF SIDS base station suite is the receiver terminal for the MAGTF SIDS outstation. The MAGTF SIDS base station also provides dissemination and connectivity between the MAGTF and external sources (e.g., theater, national, other Services) via SIPRNET or other organic electronic communications channels that are external to and separate from MAGTF SIDS.

*MAGTF Secondary Imagery Dissemination System Outstation.* The MAGTF SIDS outstation suite is used to collect and transmit tactical imagery to the MAGTF SIDS base station. The MAGTF SIDS

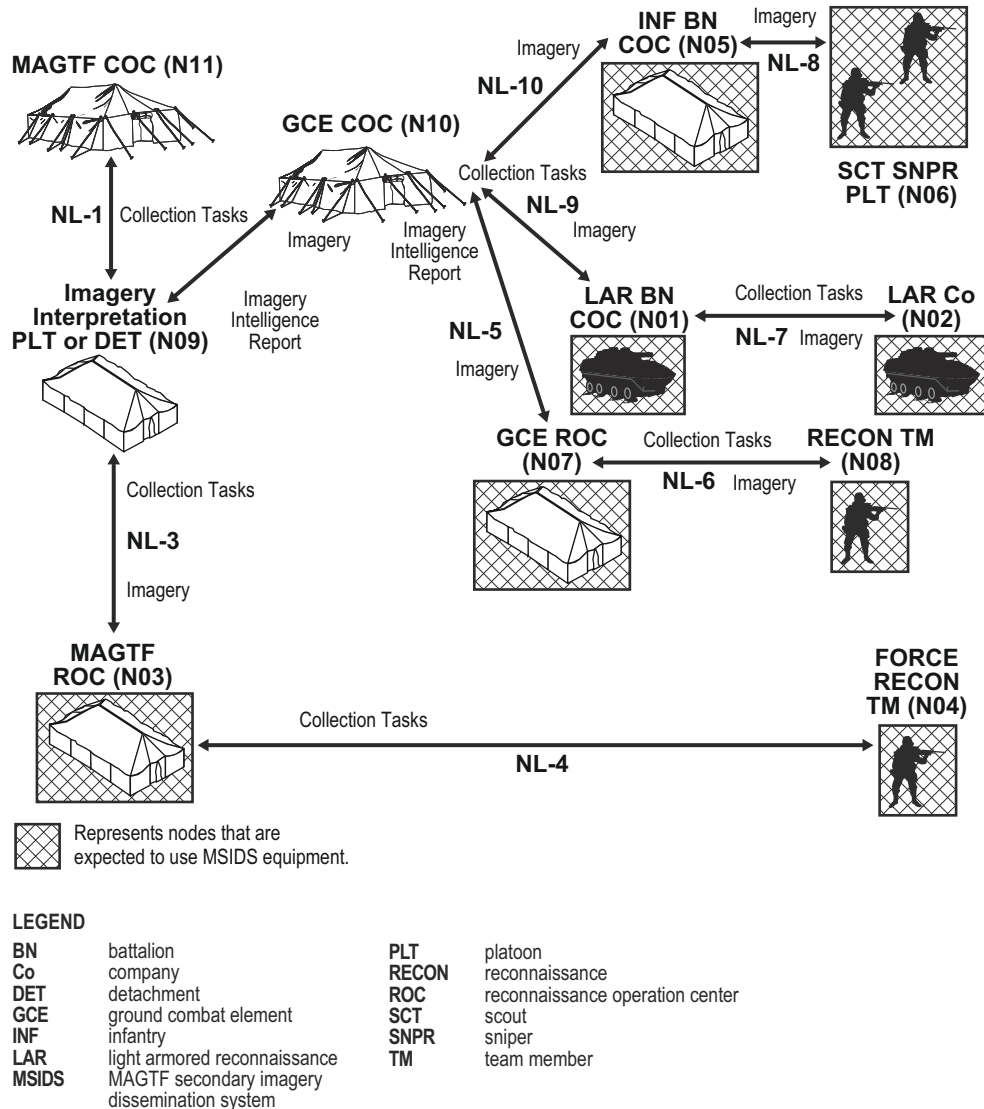

**Figure 4-8. MAGTF Secondary Imagery Dissemination System Network Architecture.**

outstation also provides dissemination and connectivity between reconnaissance teams and the reconnaissance operation center or command operations center via organic electronic communication channels that are external to and separate from MAGTF SIDS.

*MAGTF Secondary Imagery Dissemination System Video Exploitation Workstations.* The MAGTF SIDS video exploitation workstation enables scanning, editing, copying, printing, manipulation, cataloging, and presenting of still and video images from various sources, including captured media. It enables users to select and sort through large amounts of data gathered from either the operating forces or supporting aircraft. Imagery can be imported into the MAGTF SIDS video exploitation workstation in an analog format, such as Hi8, mini-digital video or DV, VHS [video home system] tape. It could also be imported in a digital format through DVD [digital video disc]/CD [compact disc], scanner, directly from a digital camera, with digital camera cards via a multiscard reader, or through SIPRNET.

**Imagery Tasking, Processing, Exploitation, and Dissemination Capabilities**

The Marine Corps possesses organic imagery tasking, processing, exploitation, and dissemination capability. Access to national, joint, theater, and Service processing and production capabilities will therefore be important elements of the Marine Corps imagery architecture (see fig. 4-9). The following subparagraphs provide descriptions of key IMINT processing, exploitation, and production information systems.

**Imagery Reachback Site—Marine Corps Intelligence Activity.** The MCIA provides 24-hour dissemination of national and commercial imagery to MAGTFs and other Marine Corps units (including the supporting establishment). Dissemination of imagery is accomplished via the Global Broadcast System or SIPRNET. The MCIA’s intelligence, imagery, database systems, and requirements include direct feed imagery product library and imagery exploitation support system. The MCIA—

- Receives, stores, and exploits digital NRT imagery from national, commercial, and theater imagery collection platforms.
- Allows general message-level imagery access to Marine Corps elements and a select group of remote clients for imagery analysis.

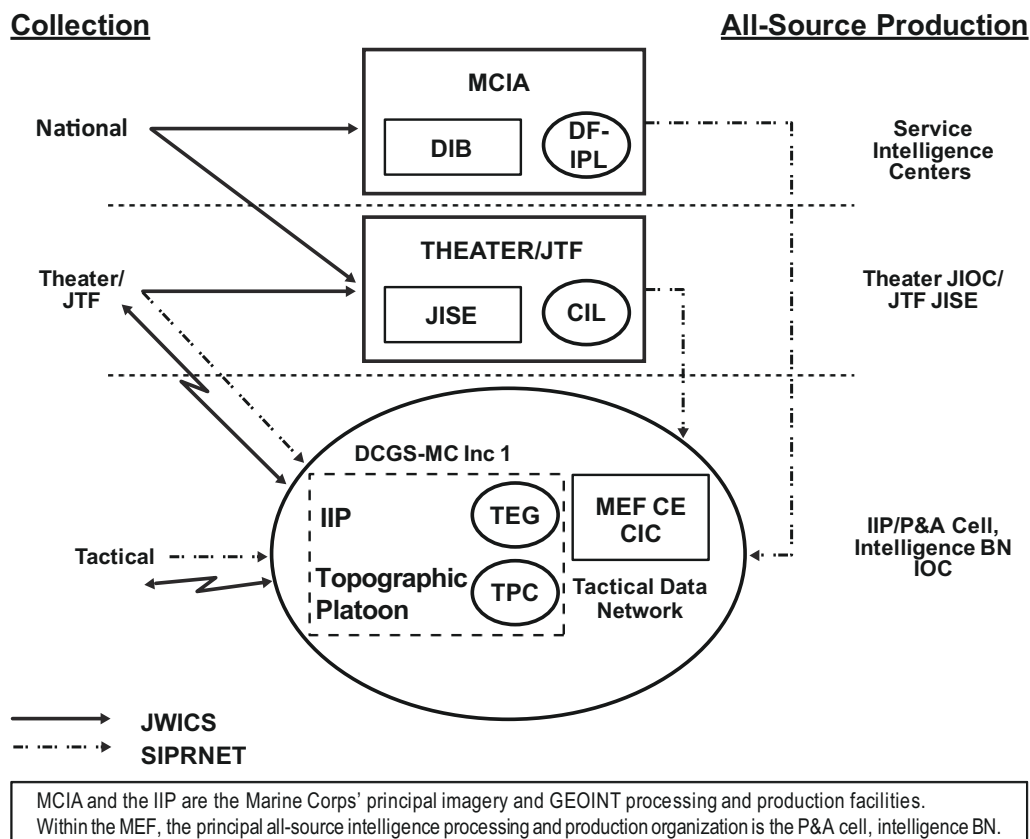

**LEGEND**

BN	battalion	DF-IPL	Direct Feed Imagery Product Library
CE	command element	TPC	topographic production capability
CIL	command information libraries		

**Figure 4-9. Marine Corps Imagery Architecture.**

- Provides customers with a search tool for querying its holdings.
- Maintains a current set of national imagery on pre-selected locations relevant to expeditionary operations. These images are updated continually.

**Tactical Exploitation Group.** The TEG family of systems provides the Marine Corps with a highly mobile tactical imagery ground station capability to analyze aerial imagery from national, theater, and tactical reconnaissance assets and develop imagery products/reports for dissemination in support of both MAGTF and joint operations.

The primary goal of the TEG FoS is to provide responsive imagery exploitation support to the Marine air-ground task force (MAGTF) for tactical operations, strike planning, detection, location of targets of opportunity, and battle damage assessment (BDA) for re-strike planning and intelligence assessment. The Tactical Exploitation Group (TEG) System is the primary tactical imagery exploitation system in the Marine Corps and is one of the capabilities comprising the Distributed Common Ground/Surface System-Marine Corps (DCGS-MC) Geospatial Intelligence (GEOINT). This equipment will be used by the 0241's in garrison, field, shipboard operations, and training exercises. The TEG FoS is comprised of modular and scalable configurations and employs Commercial Off-the-Shelf, Government-Off-the-Shelf, and Non-Developmental Item computer hardware and software to enable rapid upgrade and to maintain commonality with Marine Intelligence and Joint Imagery Systems. The TEG FoS is comprised of the VIP-MC and TEG-RWS (see fig. 3-2 on page 3-4).

### **Imagery Communications and Information Systems Architecture**

Figure 4-10, on page 4-18, and figure 4-11, on page 4-19, depict the internal IMINT CIS architecture for a MEF and the broader IMINT CIS architecture through the theater and national levels.

### **Geospatial Intelligence Communications and Information Systems Planning Considerations**

The MAGTF CIS requirements and planning considerations for GEOINT operations include the following:

- Ensuring the MAGTF command element and subordinate elements are included in the distribution of IMINT-related address indicator groups to receive pertinent tactical, theater, and national intelligence and GEOINT products.
- Determining, establishing, and coordinating communication requirements and operational procedures in support of GEOINT operations.
- Coordinating IMINT CIS activation and restoration priorities and supporting procedures.
- Identifying and procuring community security materiel system requirements for unique IMINT communications.
- Determining and coordinating intelligence network information systems requirements in support of IMINT operations, such as hardware, software, internet protocol addresses, accreditation, or authority to operate/connect.
- Integrating MAGTF IMINT element CIS operations with those of other MAGTF, pertinent JTF, and other components intelligence and reconnaissance units, such as mutual support and cueing.

- Integrating CIS of IMINT elements employed in general support with collocated ground combat element, ACE, LCE, and other MAGTF elements.
- Coordinating MAGTF GEOINT databases administration and operations.
- Coordinating GEOINT CIS and TCPED operations and procedures with other Services, as well as allied and coalition forces.

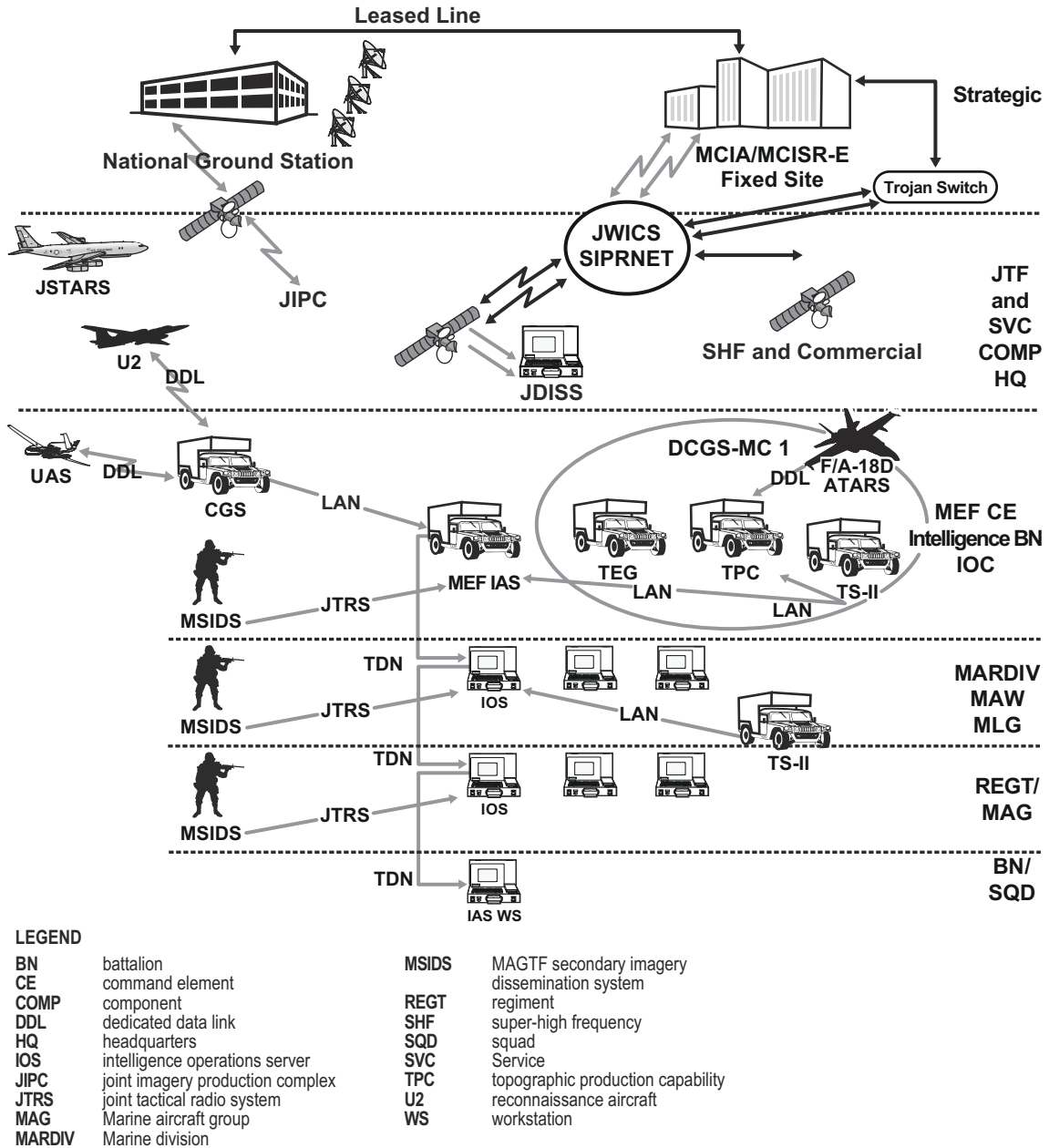
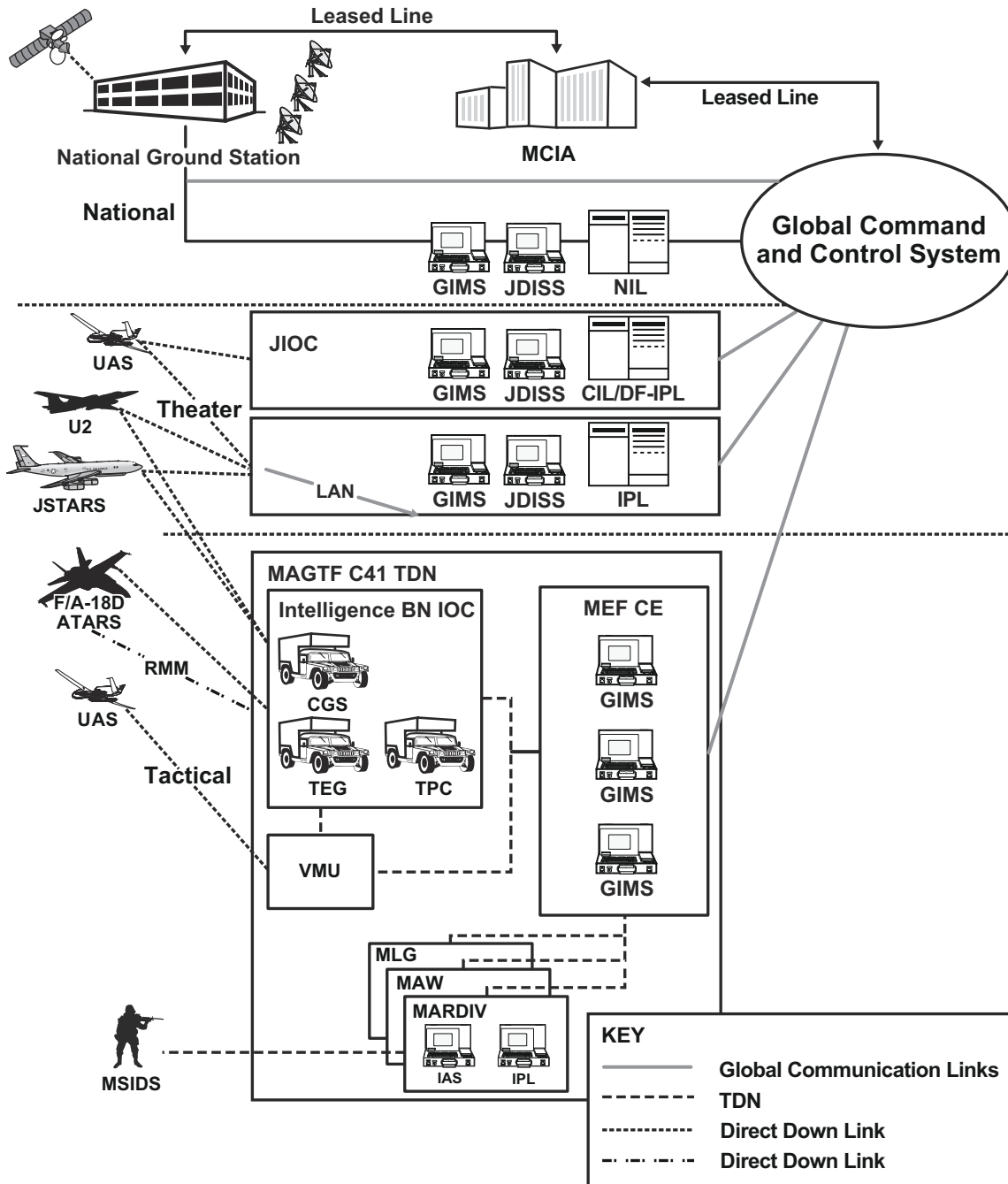

Figure 4-10. Internal Communication and Information Systems Imagery Intelligence Architecture.





LEGEND

BN battalion  
 CE command element  
 CIL Command Information Library  
 CM collection management  
 DF-IPL Direct Feed Imagery Product Library  
 FoS family of systems  
 GIMS Geospatial Information Management System

MARDIV Marine division  
 MDC metadata catalog  
 MSIDS MAGTF secondary imagery dissemination system  
 Nav navigational  
 NIL National Information Library  
 RMM removable memory module  
 TPC topographic production capability

Figure 4-11. Broader Communications and Information Systems Imagery Intelligence Architecture.

# CHAPTER 5

## PLANNING

The following functions are key to planning:

- Developing a plan that directs and coordinates action.
- Fostering shared situational awareness.
- Generating common expectations about how actions will evolve and affect the desired outcome.
- Supporting the exercise of initiative.
- Shaping the thought processes of planners.

---

### SUPPORT TO THE PLANNING PROCESS

When providing support to the planning process the following should be considered: planning for imagery intelligence; types of imagery; aerial imagery collection missions; and processing, exploitation, and dissemination of imagery and imagery intelligence.

#### **Planning for Imagery Intelligence**

Planning for IMINT includes implementing the IMINT planning process, integrating imagery intelligence planning with the intelligence cycle, fulfilling imagery intelligence planning considerations, and understanding planning responsibilities.

***Imagery Intelligence Planning Process.*** There are eight steps in the IMINT planning process.

*Planning.* The first step is to determine the exact needs—including key collection, production, and dissemination requirements—so that priorities are accurately determined, resources are not overwhelmed, and timely support is provided.

*Requesting.* The most important part of any request is to clearly articulate the IMINT intelligence requirement. Each intelligence request should include the mission and how the intelligence product being sought will fulfill the stated need.

*Validating.* Intelligence and imagery should be reviewed to determine whether or not the intelligence requirement can be answered immediately. If not, the intelligence requirement should be checked against previously validated intelligence requirements and ongoing/planned intelligence operations to avoid unnecessary duplication. Finally, the intelligence requirement should be checked against the capabilities of the intelligence assets supporting the unit. If the intelligence

requirement is validated using these criteria, then a priority will be assigned to the intelligence requirement and associated intelligence collection, production, and/or dissemination requirements (e.g., ICRs, intelligence production requirements, and intelligence dissemination requirements) will be developed and prioritized.

*Planning and Tasking.* The collection manager determines the tasking by which the intelligence requirement will be satisfied—either organic or external intelligence operations will be tasked to satisfy the intelligence requirement. If collection is required, the CM/DO determines the best intelligence asset to perform the mission. Concurrently, the CM/DO develops plans and tasks to ensure projected dissemination requirements can be fulfilled, while the geospatial support team develops necessary production plans and tasking. The requirements can be fulfilled using either organic or external assets: when organic intelligence resources are used, appropriate orders shall be issued; when external support is required, the intelligence requirement shall be submitted to either higher headquarters or supporting organizations.

*Collecting.* The validated ICRs and intelligence production requirements are used to ensure the most effective type of imagery is collected to satisfy the overall intelligence requirements. The capabilities and limitations of each imagery collection element, the time the collection must occur, and the weather influence is the nature of collection operations.

*Exploiting.* Requirements for IMINT exploitation are defined in terms of three phases. Each phase represents a greater degree of analysis and a longer period of time available to accomplish the exploitation and associated production.

The first phase includes the rapid exploitation of newly acquired imagery, and reporting of imagery-derived intelligence and intelligence information within a specified period of time from the receipt of imagery. Phase one satisfies priority requirements related to immediate needs and/or identifies changes or activity of immediate significance.

Like phase one, the second phase includes the detailed exploitation of newly acquired imagery; however, the reporting of imagery-derived intelligence and intelligence information is weighed by analytic requirements and timeliness of need. Phase two provides for an organized and comprehensive account of the intelligence or intelligence information extracted from newly acquired imagery and is supported by other intelligence source materials, as appropriate.

The third phase includes the in-depth analysis of available imagery pertinent to an intelligence requirement and the reporting of results within a specified time. In response to intelligence requirements, phase three provides the most comprehensive analysis of a target or topic using imagery as the primary data source but, when appropriate, incorporates data and intelligence from other sources. The last steps of this phase are disseminating and utilizing.

*Disseminating.* Imagery intelligence products are disseminated either as hardcopy or softcopy products. Hardcopy products are disseminated via couriers or the available mail system. Softcopy products may also be distributed as hardcopy products or electronically via the MAGTF communications network. The requestor and the supporting G-2/S-2s, with assistance from units' G-6/S-6, must ensure that the requested product can be transmitted over the available supporting CIS.

*Use.* As it is with the intelligence process, the last step of the IMINT planning and execution process, effective utilization, is the most important. Commanders and other imagery/IMINT users should notify the G-2/S-2 regularly regarding both the quality of the products and how well particular products answered their CCIRs and intelligence requirements. Additionally, new intelligence requirements that result from new imagery/IMINT should be identified and action should be initiated to plan future operations effectively. Finally, providing the G-2/S-2 and IMINT elements with feedback will help to identify problems and allow improvements to be developed and implemented quickly.

***Integrating Imagery Intelligence Planning with the Intelligence Cycle.*** The intelligence cycle is a procedural framework used for developing mission-focused intelligence support for the range of military operations. The intelligence cycle should be applied in a manner that develops the required intelligence in the most effective way. The application of the intelligence cycle will vary during mission planning and execution. Application of the intelligence cycle is driven by intelligence requirements. In theory, a unique iteration of the intelligence cycle is carried out for each individual intelligence requirement. However, in practice intelligence requirements are grouped together and satisfied through a single, intelligence development process that addresses all intelligence requirements, including IMINT requirements, concurrently.

During planning, the application of the intelligence cycle supports mission analysis, COA development, and COA wargaming by providing basic intelligence, including IMINT, in the form of intelligence estimates, supporting studies, and IPB analyses that describe the battlespace and threat. (See app. C for detailed information regarding imagery and IMINT support to IPB and other all-source intelligence products.)

During COA comparison and analysis, orders development, and transition, the intelligence cycle is applied to satisfy emerging intelligence requirements and update the intelligence estimate and IPB products—all of which may be supported by IMINT.

During execution, the intelligence cycle is applied to implement the intelligence collection, production, and dissemination plan; refine IPB analysis, and generate mission-specific multidiscipline intelligence operations and intelligence products—all of which are integrated with the CONOPS.

During execution, intelligence requirements are satisfied individually. New intelligence requirements are generated in response to specific operational needs. Each intelligence requirement is unique and must be satisfied in a timely manner to facilitate rapid decisionmaking and the generation or maintenance of tempo (see fig. 5-1 on page 5-4).

***Imagery Intelligence Planning Considerations.*** The IMINT plan should reflect proven planning principles. Considerations for IMINT planning are discussed in the following subparagraphs.

***Fulfill the Stated Requirements.*** The IMINT plan should fulfill the stated requirements. It should ensure imagery data is collected, processed, and reported to satisfy the intelligence requirements set forth in the commander's guidance and collection plan. Particular attention must be paid to the timeliness and formats of the data provided.

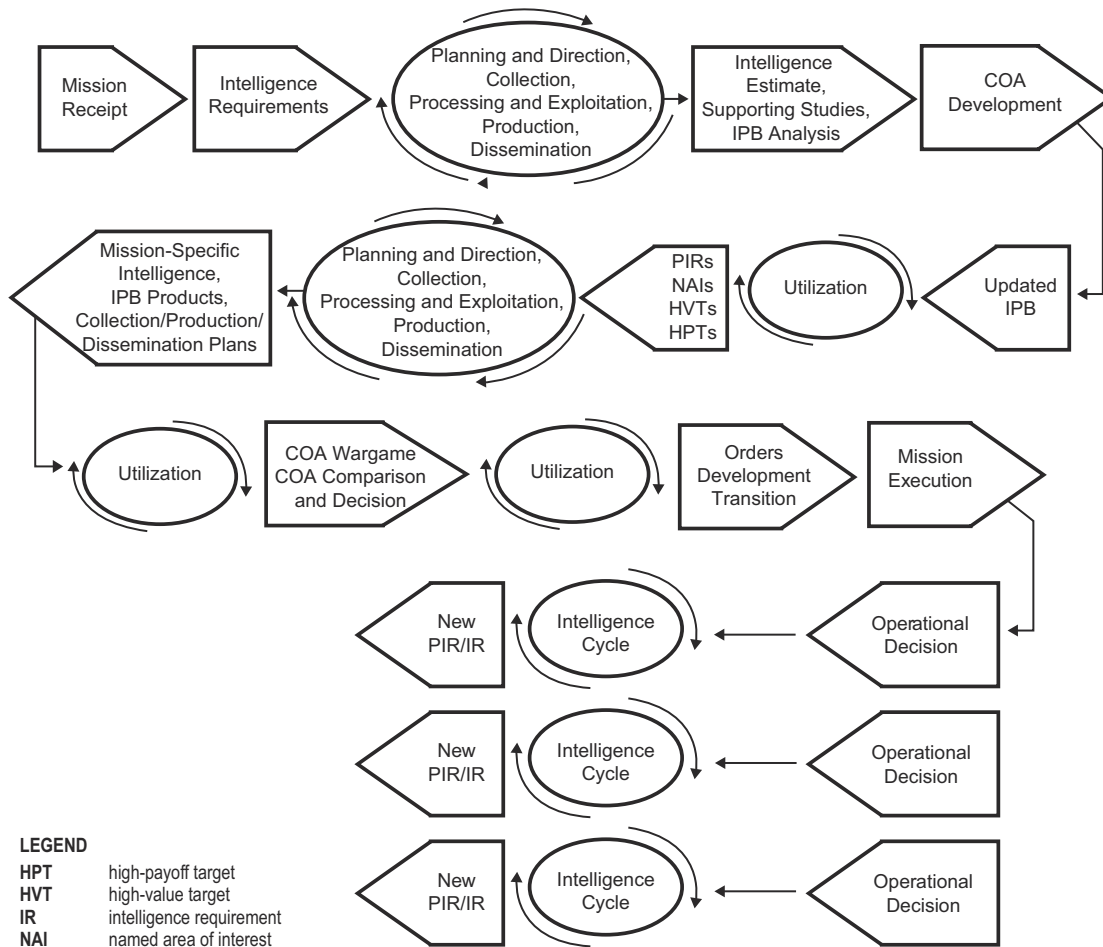

**Figure 5-1. Application of the Intelligence Cycle.**

*Integrate with Other Intelligence Plans.* The IMINT plan should be integrated with other intelligence plans. Effective IMINT planning and execution require close coordination, liaison, and integration with all-source intelligence elements. Frequently, IMINT collection management is driven by cross-cueing from SIGINT, HUMINT, and other sources of intelligence. Also, fusion of IMINT with other intelligence ultimately drives the conduct of future IMINT operations and the development of IMINT products.

*Integrate with Other Operations.* The IMINT plan must take into account the location and activities of the supported units. Planned missions must be scheduled where and when they can best collect sensor data. Additionally, C2 and CIS arrangements must be coordinated in order to ensure imagery data and IMINT are reported to the supported units. Because enemy activity may be anticipated at certain phases of military operations, IMINT operations and analytical personnel must have a situational awareness of both intelligence estimates and ongoing operations to focus their efforts at a particular time and area. Finally, the requirement for timeliness in processing and reporting may vary depending upon the stage of the operation; personnel must be aware of current timeliness requirements as well as the availability of CIS resources with all supported commands.

*Integrate into the Overall Collection Plan.* The IMINT plan should be integrated with other intelligence and reconnaissance operations to ensure the required data can still be acquired even when a planned

imagery mission is canceled or critical equipment malfunctions. The ability to provide this redundancy depends upon the number of imagery missions available, capability of other intelligence resources to acquire the information needed, and the availability of production resources.

*Make Use of All Imagery Intelligence Resources.* The IMINT plan should make use of all IMINT resources. While some imagery collection resources may be held in reserve, most units and systems can fulfill multiple missions and should be employed. Close coordination and integration of operations and intelligence activities will aid with identifying and prioritizing these multipurpose missions. Imagery intelligence production resources should not be held in reserve.

*Support the Concept of Operations.* The IMINT plan should support the CONOPS. Imagery intelligence efforts must support and adapt to the MAGTF commander's intent, concepts of intelligence and operations, and the supporting scheme of maneuver. Key questions to be answered regarding supporting the CONOPS include—

- What are the MAGTF AO and the AOI?
- What are the MAGTF CONOPS, task organization, and main and supporting efforts?
- What are the standing PIRs and intelligence requirements? Which have been tasked to supporting IMINT units? What specific information most interests the commander (e.g., enemy ground operations, enemy air operations, target BDA, friendly force protection, or enemy future intentions)?
- What is the concept of MAGTF fires support? How will MAGTF target development and target intelligence be conducted? What are the specific imagery needs in support of these tasks?
- What are the IMINT and intelligence CONOPS of other JTF, component, and/or theater resources? What are the task-organization and command/support relationships for all MAGTF intelligence and reconnaissance units?
- How can external assets be incorporated to support MAGTF operations?

*Take Into Account the Physical Environment.* The IMINT plan should take into account the physical environment, including terrain and weather. Terrain factors have a significant impact on IMINT operations, such as the ability of IMINT sensors to see through vegetation and IMINT's requirements for line of sight (LOS) communications. To be effective, all IMINT collection systems require LOS to the target area. Accordingly, IMINT planners must assess the effects of mountains, defilade, vegetation, and other potential terrain obstacles on all planned IMINT operation.

*Consider Weather as a Key Limiting Factor.* Bad weather degrades the identification and location of targets and can limit the type of imagery collection capabilities that may be employed. In addition, low ceilings and poor visibility decrease both visual reconnaissance effectiveness and the resolution of photographic systems. Weather factors to consider include the following:

- *Precipitation.* Visible moisture degrades optical and visual reconnaissance systems. Most UASs are not all-weather aircraft. Consequently, rain, ice, and snow can severely damage or even destroy a UAS.
- *Wind.* UASs are significantly more affected by wind than manned aircraft.

- *Clouds, Haze, and Smoke*. In addition to affecting the aircrew's ability to conduct visual reconnaissance, cloudy, hazy, and smoky conditions also affect EO and infrared systems on both manned aircraft and UASs.
- *Daylight, Sun Angles, and Shadows*. The angle of the sun affects visual, EO, and forward-looking infrared (FLIR) observations differently. The quality of FLIR imaging decreases as the sun rises and reaches a point where a target can be seen visually. At this point the target cannot be detected by a FLIR. Prior to sunset and just after sunrise, long shadows are cast by large terrain features and can obscure objects in their path. The ideal time to take photographs or observe a target is mid-morning or mid-afternoon. During these periods, shadows are cast long enough to add definition and dimension to a target.

*Consider the Threat.* Threats can be general or aviation related. For a general threat, a detailed threat analysis must be conducted to determine which imagery sensors and platforms can be employed effectively against a given enemy target, and then how to employ the limited resources available to the MAGTF to obtain the required IMINT. The enemy can, in turn, impede imagery operations by employing CCD activities as well as focusing their air defense capabilities.

Enemy air defenses have a direct effect on aerial imagery collection missions. Since aircraft must stay beyond threat air defense ranges, significant anti-aircraft artillery (AAA) and surface-to-air missile (SAM) threats may degrade visual reconnaissance. Imagery intelligence planners must assess threat air defense and air-to-air threats when evaluating risk and determining routes. Finally, threat EW capabilities must be identified and assessed in order to determine their effects on UAS and manned imagery platforms radio uplinks and imagery downlinks.

*Consider the Type of Collection.* The IMINT plan shall consider the various types of imagery collection capabilities. A variety of organic imagery collection capabilities are available to a MAGTF (see fig. 5-2 on page 5-7). The following planning considerations are critical to effective direction and employment of these resources. Imagery collection resources readily locate and identify large threat forces, moving vehicles, weapon systems, structures and other topographic features that contrast with their surroundings. Conversely, small, stationary/well-camouflaged enemy forces blending into their surroundings can be difficult to locate and identify. Generally, it is better to employ imagery collection resources against point targets rather than in a wide area search mode. Effective integration with other intelligence operations can cue imagery collectors to key targets, reducing the search area, thereby reducing the time required to produce actionable intelligence.

*Area Reconnaissance.* Area reconnaissance is the systematic and complete coverage of an area using visual/imaging means. Area reconnaissance is normally used to locate/identify specific targets for further collection and analysis. It is also used to support terrain analysis. Area reconnaissance imagery can be collected two different ways: first, by imaging back and forth across a predetermined area so that flight lines and individual images overlap—this process provides complete coverage of all objects within the area at the expense of increased sensor utilization time; second, by adjusting focal lengths/altitudes to allow a lesser number of images to cover the target area. This process reduces time on target (TOT) as well as the processing, exploitation, and dissemination time at the expense of reduced resolution. Types of area reconnaissance imagery missions include broad area coverage/surveillance and directed search area missions.

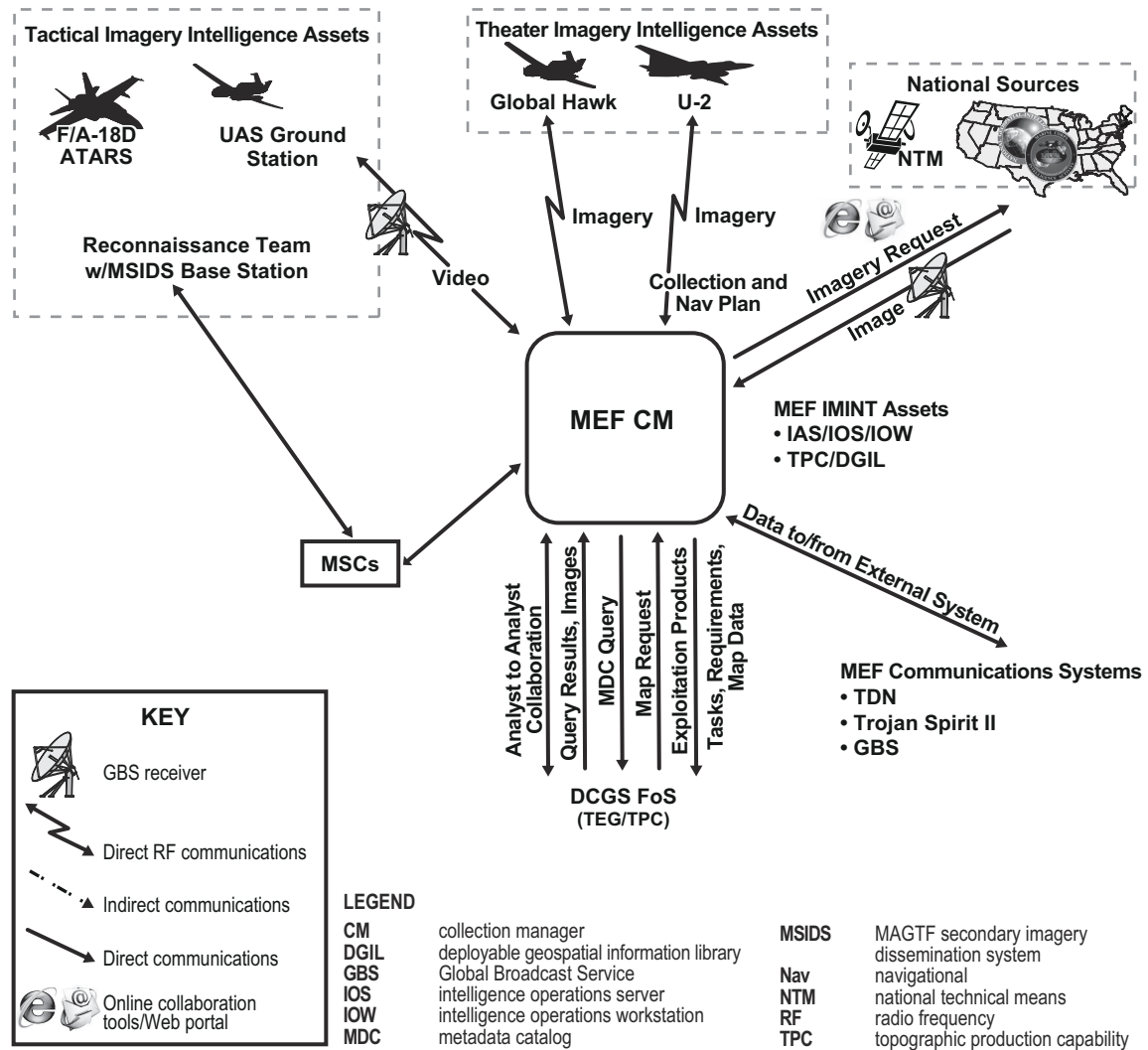

**Figure 5-2. Marine Expeditionary Force Imagery Collection Capabilities.**

Broad area coverage/broad area surveillance are area reconnaissance imagery collection tactics that provide an overview of an entire area. They should not be the primary collection tactics utilized to collect against known point targets. (During area collection operations, the flight tracks/routes are planned and the image exposures adjusted so that each successive image will overlap the previous one.) During the early phases of an operation broad area coverage and broad area surveillance may be conducted for two intelligence purposes: first, providing a basis for the procurement of larger scale imagery of selected areas for subsequent detailed analysis; second, serving as a comparative baseline for determining the nature and extent of changes identified on subsequent missions.

Directed search area missions provide focus and detail, and are useful for OOB confirmation counts.

Point Targets. Point targets are normally tasked to provide the highest possible resolution of a specific target that allows for detailed analysis. Point targets can vary in size and include command posts, bridges, airfields, and SAM sites.



Line of Communications. Line of communications collections involve imaging along specific transportation routes, such as roads, railroads, or waterways. This type of reconnaissance is normally conducted to determine enemy movement or potential usability of a route; it can also support mapping or terrain analysis requirements. This methodology is good for maneuverability studies, but generally requires significant time for effective exploitation. Line of communications missions should be conducted ahead of time as a contingency baseline.

**Planning Responsibilities.** Imagery intelligence planning is a continuous function that requires close interaction between the G-2/S-2 and IMINT unit planners. Key objectives include the following:

- Identifying IMINT requirements.
- Preparing IMINT operations plans.
- Planning and establishing the IMINT support system.
- Issuing orders/tasking to IMINT units.
- Supervising and coordinating IMINT operations.

*Assistant Chief of Staff G-2/S-2.* Primary staff responsibility for the planning of IMINT operations lies with the AC/S G-2/S-2. Specific responsibilities of the AC/S G-2/S-2 include the following:

- Preparation of integrated, multidiscipline intelligence and reconnaissance operations and supporting IMINT plans, orders, annexes, and appendices.
- Coordination with the G-3/S-3 to ensure the planned IMINT plan supports both the CONOPS and scheme of maneuver.
- Coordination with the G-6/S-6 officer for CIS support to the IMINT elements, including circuits, network access, frequency assignment, equipment, and call signs.
- Liaison with IMINT agencies and units external to the MAGTF. Identifying, preparing (including all required equipment), and locating IMINT or all-source intelligence liaison elements to support MAGTF IMINT operations is a critical early planning action. The IMINT liaison teams will be small in number due to the limited availability of imagery personnel.
- Coordination with the G-4/S-4 to ensure adequate logistic support of IMINT elements.

*Intelligence Battalion Commander/Detachment Officer in Charge.* The intelligence battalion commander/detachment OIC is responsible to the AC/S G-2/S-2 (or in some cases the MAGTF intelligence operations officer) for the planning, direction, and execution of MAGTF IMINT operations. Specific duties of the battalion commander/detachment OIC include the following:

- Advising the G-2/S-2 on IMINT employment and its integration with other Services, JTF, theater, and national IMINT operations.
- Preparing MAGTF IMINT plans and orders in conjunction with other intelligence section staff officers and key intelligence battalion subordinates.
- Planning, supervising, and assisting IMINT collection requirements and tasking for MAGTF operations, in conjunction with the CM/DO.

- Coordinating the movement, operation, and reporting of IMINT units in coordination with the SARC OIC and the G-3/S-3.
- Coordinating MAGTF IOC analyst exchanges with IMINT analysts and the integration of GEOINT products with all-source intelligence production in conjunction with the MAGTF IOC OIC. The battalion commander/detachment OIC must take into account the strenuous mental and physical demands on imagery analysts during sustained operations, particularly when planning watch schedules for imagery analysts performing detailed imagery exploitation tasks.
- Planning for the timely reporting of IMINT to both MAGTF and external elements and the rapid handling of time sensitive information in coordination with the CM/DO.
- Planning and coordinating IMINT communications paths and information systems management and operations in conjunction with the G-6/S-6.

### **Types of Imagery**

The types of imagery are electro-optical, infrared, radar, multispectral, hyperspectral, and commercial. Certain policies apply to imagery of the United States.

**Electro-Optical Imagery.** Electro-optical imagery employs digital imaging techniques to extend and complement other imagery. Electro-optical imagery is readily exploitable by automated processors and analytical aids. It uses the visual spectrum, so anything that impacts this spectrum, such as dust, smoke, haze, clouds, rain, fog, light level, or angle of illumination, will affect the quality of the imagery.

**Infrared Imagery.** Infrared imagery systems can operate day or night under favorable weather conditions. They are less effective during day/night transition periods or when backgrounds and targets have negligible differences in temperature.

Infrared imagery is the remote sensing of the radiant temperature associated with a target. The system is used to measure the temperature differences between terrain features and surrounding objects on the ground, producing a near-optical-quality infrared image (see fig. 5-3 on page 5-11).

Unique infrared imagery capabilities include imaging the shadow on a heat-absorbing surface or the thermal scar of a heat-generating object.

**Radar Imagery.** Radar imagery can be collected day or night and under all weather conditions. Generally, it is limited only by the capability of the platforms conducting the collection mission. Radar imagery is best utilized in conjunction with other imagery sensors. Unlike EO imagery, it presents a nonliteral image of the battlespace, requiring special skills and time to analyze properly. See figure 5-4, on page 5-10, for an example of SAR imagery.

**Radar Reflection.** Radio-frequency energy is transmitted to and reflects from the reflecting object. A small portion of the energy is reflected and returns to the radar set. This returned energy is called an echo, just as it is in sound terminology. Variations in the pattern and tone of the echo are recorded and displayed as radar images.

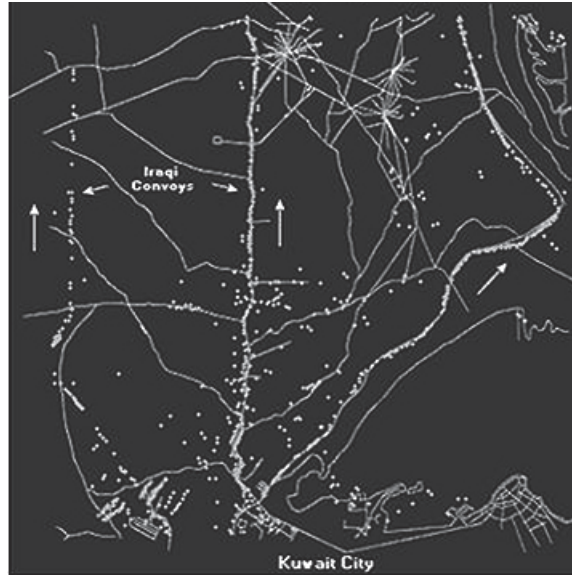

**Figure 5-3. Infrared Imagery.**



**Figure 5-4. Synthetic Aperture Radar Imagery Example.**

*Doppler Shift.* The geometry and surface composition of targets and their surroundings can greatly affect the intensity of the radar pulse return. To detect moving targets, radars employ the principle of Doppler shift. Doppler shift is the result of a moving object causing a subtle change in the frequency of the reflected pulse energy. This change is detected by comparing the original pulse energy frequency to the frequency of the reflected energy. See figure 5-5, on page 5-11, for an example of an MTI image.



**Figure 5-5. Joint Surveillance Target Attack Radar System Moving Target Indicator Imagery.**

**Multispectral Imagery.** Multispectral imagery records multiple views in several spectral bands or frequencies simultaneously. The key to interpreting these images lies in the identification of the spectral signatures of the various surfaces and targets. Whether it is generated by itself or reflected, every surface or target gives off a unique pattern of radiation. The shape of the pattern depends on the reflective qualities of the material, its heat, whether it is a solid or liquid, the smoothness of the surface, and several other factors.

**Hyperspectral Imagery.** Hyperspectral imagery sensors use hundreds of very narrow wavelength bands to *see* reflected energy from objects on the ground. This energy appears in the form of “spectral fingerprints” across the light spectrum. Once these fingerprints are detected, special algorithms—repetitive, problem-solving mathematical calculations—are used to assess them so that various natural and manmade substances can be differentiated from one another. Signature libraries may also be used to identify specific materials, such as rooftops, parking lots, grass, or mud, by comparing a library’s pre-existing reference catalogs with freshly taken hyperspectral images of the battlefield from space. Image processing equipment then portrays the various types of terrain and objects upon it in different colors forming a “color cube,” each based on the wavelength of the reflected energy captured by the image. These colors are subsequently “translated” into maps that correspond to certain types of material or objects to detect or identify military targets, such as a tank or a mobile missile launcher.

**Commercial Imagery.** The commercial imagery industry has launched and will continue to launch new high-resolution panchromatic, multispectral imagery, and other imagery systems. These systems will provide an increased capability to supplement and complement our national imagery technical collection. The HQMC Imagery and Geospatial Intelligence Branch works closely with NGA on commercial imagery issues. Marine Corps policies and procedures for requesting, tracking, obtaining, and purchasing commercial imagery are under development. These policies and procedures are promulgated from NGA’s Commercial Imagery Management Office, which publishes commercial imagery plans that improve DOD and intelligence community access to commercial imagery.

**Domestic Imagery Collection.** Domestic imagery collection includes satellite and aerial imagery of any part of the United States and its territories or possessions, including the 12 nautical miles seaward of these land areas. Before domestic imagery collection in the aforementioned geographic areas may be conducted, an approved proper use statement is required. Central to this process is a thorough review of planned missions to ensure that the constitutional rights of US citizens are protected according to current laws and executive orders restricting intelligence activities directed against US citizens within the United States. Approved proper use statements must be retained in the permanent files of the requesting unit and higher headquarters up through the combatant command headquarters. For additional information on domestic imagery collection, see NGA Imagery Policy Series [IPS] [section 9, part B], Domestic Imagery [IPS-001/98-S9A]. Request channels for domestic imagery collection are Marine Corps-specific requirements (proper use statements are submitted via the service chain of command to the MCIA/DRO) and joint operations requirements (proper use statements are submitted via the operational chain of command to the combatant commander for adjudication or follow-on action, as appropriate).

### **Aerial Imagery Collection Missions**

Aerial imagery collectors provide the flexibility to respond rapidly to changing battlespace conditions. Unmanned aircraft systems provide both the added advantage of operating in areas of heavy enemy air defenses and the needed intelligence without the risk of exposure of manned aircraft. Intelligence imagery collection planners establish detailed preplanned imagery collection routes, areas, and point targets encompassing the AOI using the results of IPB, the MAGTF's CONOPS, and scheme of maneuver.

Aerial imagery collection missions require detailed operational planning, particularly with respect to their integration with other ACE operations. Since all aerial imagery collection platforms are multipurpose, close coordination between MAGTF command element imagery planners and ACE operational planners is necessary to identify, reconcile, prioritize, and integrate competing requirements for resources. Additionally, all aerial imagery missions must be included on the ATO and coordinated with other air operations and, where pertinent, supporting arms. This coordination is particularly critical with regard to UAS operations. Unmanned aircraft systems enter the airspace control system via the appropriate airspace control agency, normally the DASC. Unmanned aircraft system controllers maintain communications with the appropriate ACE C2 agency, such as the DASC, during missions in order to receive routing, altitude, and other pertinent airspace control information.

The commander who directly tasks or controls an imagery collection mission will receive the most responsive support. The responsiveness of the mission to other commanders depends on the number of echelons through which the mission request and resulting intelligence must flow. Accordingly, when planning imagery collection operations, the advantages and disadvantages of dedicating missions to a single command (i.e., direct support) must be assessed against the MAGTF's total intelligence requirements and the current situation. Previously acquired imagery and IMINT products should always be reviewed to see if they can satisfy intelligence requirements without need of additional imagery collection missions.

Often, the intelligence acquired from an imagery collection mission (vice the actual image) will be all that is required to satisfy many intelligence requirements. Likewise, dissemination challenges

are generally simpler and faster when users' intelligence requirements can be satisfied without the images. Accordingly, to ensure optimum support, commanders must understand the pros and cons of various imagery-related intelligence requirements.

Usually, collected imagery will require additional processing and fusing with other intelligence to provide the necessary support. Depending on the situation, this may be a time-intensive task. Commanders should assess likely processing and production timelines and other requirements when developing IMINT plans.

Intelligence acquired from a number of imagery collectors may be disseminated directly to users with minimal additional intelligence processing and all-source intelligence analysis. Supporting dissemination plans must ensure identification of the type products likely disseminated as well as the technical requirements associated with these products. In the case of resources, such as the UAS or JSTARS, dissemination planning includes the establishment of dedicated communications links directly between the collector and the supported unit.

**Preplanned Missions.** Preplanned aerial imagery missions (e.g., UAS, ATARS) are requested using the joint tactical air reconnaissance/surveillance (JTAR/S) request format (see app. H, section I). Within the MAGTF, preplanned aerial imagery requests are routed through the intelligence chain and consolidated by the MAGTF command element's intelligence section for validation, prioritization, and follow-on planning and coordination.

**Immediate Missions.** Immediate requests for aerial imagery collection will be submitted via the operational chain of command to the DASC. However, this is rarely done because available resources are generally limited and operate in general support of MAGTF requirements. The joint tactical air strike request format (see app. H, section II) may be used to request immediate aerial imagery collection support. When approved, the mission may be executed in one of the following ways:

- An ongoing mission can be diverted by its controlling authority to conduct the immediate mission.
- An on-call/standby mission may be allocated.

**Air Planning and the Air Tasking Cycle.** The air tasking cycle is the key tool used by MAGTF planners to plot most air operations (i.e., pre-planned and immediate) to support mission accomplishment. By using and completing the air tasking cycle, planners can ensure that, with correct prioritization, aviation assets can be used most effectively, while maintaining command and control and CIS in support of the MAGTF.

*The Air Tasking Order.* The principal planning product of the air tasking cycle is the MAGTF ATO or air plan. The ATO is a document generated by the joint force air component commander or the ACE commander. It tasks and disseminates the specific missions and targets of projected air sorties, capabilities, and forces to JTF components, subordinate units, and C2 agencies. It normally provides both general and specific instructions, including call signs, targets, and controlling agencies. The airspace control order is included in the ATO. Special instructions that provide amplifying notes, important details, and changes are included in the ATO or issued

separately. The ATO, airspace control order, and special instructions provide operational and tactical direction at appropriate levels of detail. For further information on the air tasking order, see MCWP 3-25.

*Phases of the Air Tasking Order.* The six phases of the ATO cycle are command aviation guidance, target/air support mission development, allocation and allotment, tasking, force execution, and combat assessment (see fig. 5-6).

**Requesting Joint Task Force, Theater, and National Imagery Support.** Significant imagery and IMINT support is available to the MAGTF from external sources, ranging from dissemination of existing imagery and products through the integration of existing information into new products and execution of new imagery collection and IMINT production. Those MAGTF intelligence requirements that cannot be satisfied by organic resources will be submitted to the next higher command echelon for validation, prioritization and, if possible, satisfying the RFI or collection requirements through its organic resources, before forwarding it to the next higher command echelon. The specific intelligence requirement will determine how the requirement is identified and submitted. Techniques include the use of the standard RFI and the use of collection/production management systems and procedures. Figure 5-7, on page 5-15, identifies the two different tracks external imagery and IMINT requirements may take.

**Processing, Exploitation, and Dissemination of Imagery and Imagery Intelligence**

**Processing.** The processing of imagery and IMINT involves the conversion of collected data into information that is suitable for the production of intelligence.

**Exploitation.** The exploitation of imagery and IMINT is the activity that converts information into intelligence. It fuses new information and existing intelligence from all sources to provide

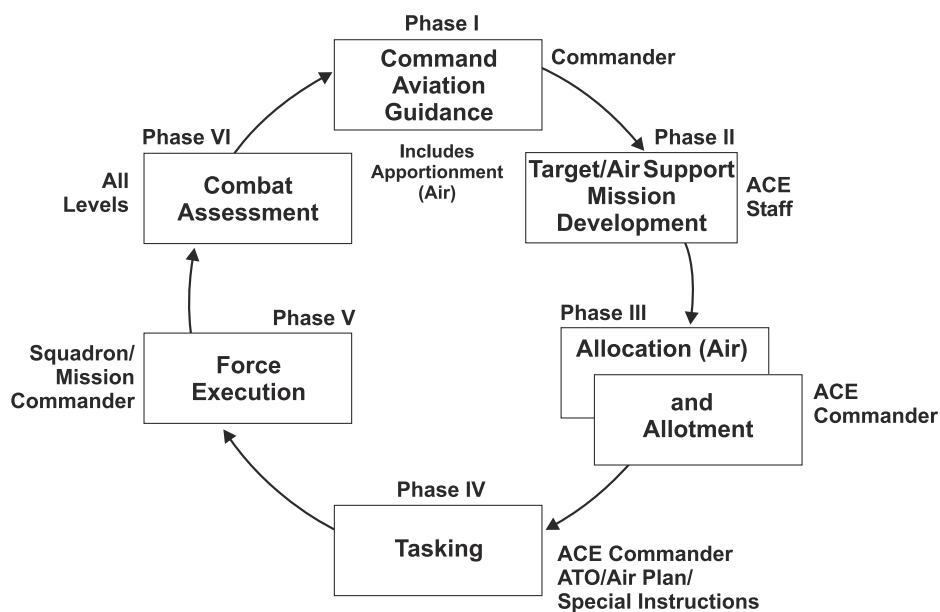
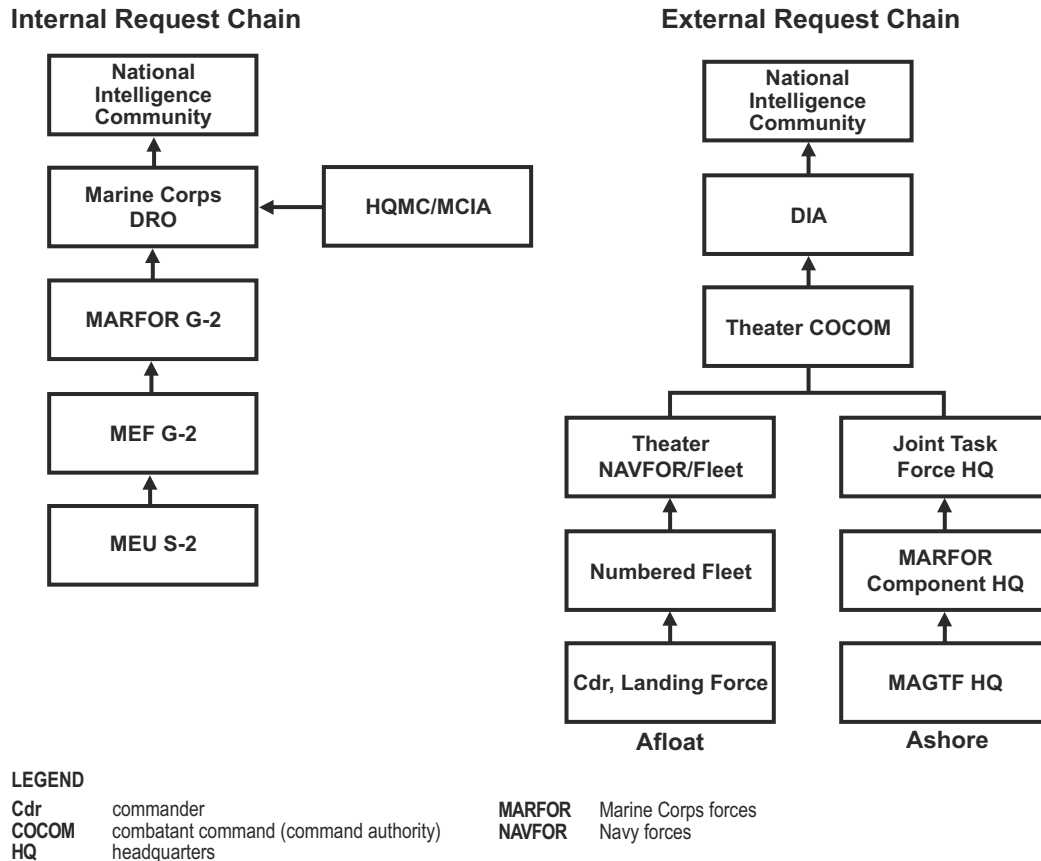

Figure 5-6. The Six-Phase Aviation Tasking Cycle.



**Figure 5-7. Requesting Imagery and Imagery Intelligence Support.**

meaningful knowledge that can be used for decisionmaking. Exploitation involves the evaluation, interpretation, integration, analysis, and synthesis of all information that is relevant to a particular intelligence requirement in order to answer the question(s) that have been asked.

*Imagery Derived Products.* Imagery derived products are secondary products that can be used to facilitate disclosure and release to coalition partners. They are useful for a variety of planning and decisionmaking activities. Several of the most commonly requested products include the following:

- Beach studies.
- HLZ studies.
- Raid studies.

*Imagery Intelligence Text Products.* Imagery intelligence text products are selected to meet the specific needs of the commander. Appendix F provides the format and instructions for completing the basic IMINT reports described in the following subparagraphs.

Reconnaissance Exploitation Report. The RECCEXREP is used to report the results from the first rapid analysis of imagery, including the debriefing of the aircrew when possible. It addresses the targets requested in the original imagery collection mission tasking, normally with each target addressed separately. It is prepared by intelligence personnel, such as IIP, MAW, or MLG, based on input



from the supporting collecting unit's intelligence section. The report is then disseminated according to the dissemination plan. The SOP designates the specified time limit in which the RECCEXREP must be completed and disseminated.

Initial Photo Interpretation Report. The IPIR provides information regarding tasked imagery collection missions not previously reported (e.g., in the RECCEXREP), when extensive or detailed data from a systematic review of the imagery is required, or when the rapid response required by the RECCEXREP would be hindered by the format, size, or quality of the imagery involved. It also is prepared by the IIP—with input from the supporting collecting unit's intelligence section—and disseminated in accordance with the dissemination plan. The timeline for completing this report is in accordance with the unit SOP.

Supplemental Photographic Interpretation Report. The SUPIR provides information not previously included in a RECCEXREP or IPIR. It reports on significant targets covered by the mission and other required supplemental data. It is prepared by intelligence personnel (e.g., IIP, MAW, MLG) based on input from the supporting collecting unit's intelligence section. The report is then disseminated in accordance with the dissemination plan. The SOP designates the specified time limit in which the SUPIR must be completed and disseminated.

SALUTE Report. The standard SALUTE format is used to report any known or suspected enemy activity. It may also be used to report any characteristics of the AO that affect mission accomplishment. The SALUTE report may be used by a VMU, ground reconnaissance unit, aircrew, or other personnel to report key information obtained during ongoing imagery collection operations. It will be disseminated in accordance with the dissemination plan, generally from the collector to the SARC or directly from the collector to other supported units.

*Imagery Intelligence Support to Other All-Source Intelligence Products.* Imagery alone will provide useful intelligence to commanders and planners (see app. C). However, intelligence requirements usually will be satisfied more effectively and in greater detail via the complementary combination of an image and supporting IMINT or all-source intelligence products. Review appendix H for an appreciation of the greater intelligence value of a complementary imagery/intelligence report product, vice simply an image product. Target analysis and target material production are examples of such support.

Target Analysis. Generally, the imagery analyst's first responsibility is the detection and accurate identification of areas and activities for situation development and support to targeting. Target detection begins with either general or specific search modes.

General search is undertaken in response to requests for broad area intelligence and usually involves the analytical examination of the entire image. Such searches should be kept to a minimum.

Specific search is undertaken in response to an intelligence requirement that requires point, strip, or route reconnaissance imagery. Its scope and objectives are more limited than general search. Target identification consists of the interpretation of visual cues or distinctive features of targets/objects detected during collection. The distinctive features are analyzed using the six Ss: size, shape, shadow, shade, surroundings, and signal strength. The depth and scope of the analysis is

highly dependent upon the purpose of the analysis and the time constraints of the associated intelligence requirement. Target identification may include the following:

- Determining the OOB and BDAs of threat units and systems at different echelons.
- Identifying both equipment and its intended use by the threat forces.
- Determining the purpose and composition of ports, harbors, waterways, airfields, roadways, railways, and installations.
- Detecting and identifying non-threat forces and equipment and sensitive targets (e.g., religious facilities).

Target Material Production. In accordance with Chairman of the Joint Chiefs of Staff Instruction (CJCSI) 3505.01B, *Target Coordinate Mensuration Certification and Program Accreditation*, a number of imagery analysis specialists at each MEF, the MCIA, and other locations must be certified under an NGA-accredited program to perform precise point mensuration in support of coordinates-seeking weapons and other precision-guided munitions. During fiscal year 2012, III MEF and the MCIA became the first organizations to be certified in precise point mensuration. During fiscal year 2015, II MEF became certified through the Air Force Precise Point Positioning Program (AFP4). I MEF will be certified during fiscal years 2016, with full program implementation planned for fiscal year 2016.

See appendix I for information on target folders and IMINT support to these activities.

***Dissemination and Reporting.*** Imagery intelligence dissemination planning and management involves establishing dissemination priorities, stipulating dissemination and reporting criteria, selecting dissemination means, and monitoring the flow of IMINT reporting. The goal of this process is to deliver IMINT products to the appropriate user in the proper format at the right time, while preventing the dissemination of irrelevant products and avoiding information overload. The following subparagraphs address the most common considerations for intelligence dissemination planners when developing IMINT dissemination plans.

*Identify Dissemination Requirements.* When identifying requirements, the four Ws—who, where, what, and when—are a good start for determining the broad scope of dissemination needs.

Who. Commander preferences, standing theater OPLAN/concept plans (CONPLANS), type mission analyses, unit SOPs, TTP, playbooks, and previous post-exercise analyses and lessons learned reports are all key sources for identifying organizations, units, and other elements to which the intelligence section must disseminate imagery and IMINT. Identifying and grouping by common imagery and IMINT product requirements by typical command relationship/task organization provides the operational perspective to begin dissemination planning. *Who* receives this imagery can either be internal or subordinate elements and units.

Internal MEF/MAGTF headquarters include a current operations center, future operations center, tactical command echelon (when deployed), force fires coordination center, rear area operations center (when established), civil-military operations center (when established). The subordinate elements and units include intelligence sections of the ground combat element, ACE, and LCE; other MAGTFs and independent task forces; organic/attached/direct support intelligence and

reconnaissance units over which the MEF retains operational control (via either the SARC, other G-2 sections, geospatial support team, and/or direct to the intelligence/reconnaissance units' command posts); and other C2 nodes and facilities, when required (e.g., DASC, enemy prisoners of war compound, rear area operations center, and/or airfield arrival control group).

Where. Generally, the answer to the *where* question will be the location of each identified *who*. However, command relationships, the specific operational phase, task organization, or other factors may identify additional answers to *where* requirements are to be disseminated.

What. With the above information in hand, dissemination planners seek answers to the *what* of each requirement. Here, planners strive to establish or anticipate what type intelligence support (e.g., finished intelligence, particular formats) each *who* typically requires to support his planning and decisionmaking needs. As with the *who* determinations, commander preferences, standing theater OPLAN/CONPLANS, type mission analyses, unit SOPs, TTP and playbooks, and previous post-exercise analyses and lessons learned reports will provide the dissemination SOP foundation and isolate the necessary information. Additionally, planners' research should encompass how differing intelligence resource task organizations affect such requirements and to how they historically have been combined to satisfy the *who* requirements. Cross-referencing the *who* and *what* answers with the following groupings completes this step:

- Typical standalone imagery and IMINT products and IMINT support to all-source intelligence products.
- Alarm intelligence support (e.g., I&W reports, time-sensitive target of opportunity reporting).
- Preferred level(s) of classified information that the *who* desires (further subdivided into what they require access to and what they can actually retain on hand).

When. The final dissemination planning information requirement is to determine to which organizations, units, and other elements (*who*) the intelligence section must disseminate imagery and IMINT or to define the stated *when*. The same sources used to research the previous *Ws* likewise are recommended for acquiring initial *when* answers and baseline planning criteria. However, this factor is arguably the most variable during tactical operations. Key planning considerations include the following:

- Nature of the requirement (e.g., is it a PIR or in support of another functional information requirement?).
- Rapidly assessing the feasibility of satisfying the decisionmaker's or planner's stated latest time intelligence is of value (LTIOV): Is intelligence already on-hand? Can organic assets acquire or produce needed intelligence? Will external support be needed?
- Communications and networks transmission requirements to support the desired format for the *who* (e.g., voice, text, digital, bulk delivery).
- Capabilities/current status of MAGTF CIS.

*Develop Dissemination Plan.* Once the four *Ws* have been completed, the answers can be translated into an IMINT dissemination plan. Imagery intelligence personnel must maintain close coordination with all G-2/S-2 officers, G-3/S-3 planners, and pertinent intelligence personnel at higher, adjacent, supporting, and subordinate organizations.

*Design and Coordinate Architecture.* The architecture should be designed schematically so that it depicts organizations, type intelligence systems, and CIS connectivity among the forces' (i.e., MAGTF, national, theater) intelligence collectors/producers and the supported decisionmakers/planners. Since planned architectures must incorporate sufficient flexibility to adjust quickly to changing tactical circumstances, it must depict both primary and alternate pipeline and alarm channels and the demand-pull and supply-push methodologies. The large data communications bandwidths associated with imagery dissemination require close planning and coordination between MAGTF intelligence and CIS planners. See appendix J for additional technical information on NITF compression that is useful when designing and coordinating CIS support to IMINT dissemination.

*Establish Imagery Intelligence Dissemination Procedures.* If intelligence dissemination is to be effective, comprehensive, MAGTF-wide integrated operations—CIS—intelligence procedures are mandatory. The answers to the four Ws will form the foundation on which the MEF's intelligence dissemination architecture and operations can be built.

*Allocate or Obtain Resources.* The G-2/S-2, in concert with the unit's CIS officer and G-3/S-3, should allocate available resources to accommodate dissemination of the requested IMINT. If resources do not exist to transmit the required information, a request for augmentation from higher headquarters or assistance from lateral units should be initiated immediately. It may be necessary to arrange for the delivery of intelligence directly from the producer to the requester if means are in place.

*Coordinate.* Once IMINT requirements have been identified and the initial plans developed, planners should develop and coordinate detailed dissemination plans.

*Monitor Execution.* Following the dissemination of imagery or IMINT products to the requester, it is important to evaluate the flow of information to determine whether or not the user is satisfied with the quantity and quality of intelligence and to ensure that preplanned filters are eliminating circular reporting. Frequent checks with the requestor can ensure intelligence utilization and preclude unanticipated demands on the G-2/S-2 staff.

***Imagery Intelligence Utilization.*** The specific utilization of IMINT is based upon the CONOPS and the imagery application being employed. Commanders, G-2/S-2s, and G-3/S-3s must evaluate IMINT products and reports continuously for timeliness, usefulness, overall quality, and responsiveness to stated PIRs and intelligence requirements. Additionally, evaluators should provide feedback to the MAGTF G-2/S-2 and IMINT planners to improve future IMINT operations.

***Imagery Intelligence Operations Appendix.*** Guidance for conducting IMINT operations comes from many sources. The DIA and the NGA issue policies, direction, guidance, and instructions regarding compliance with national IMINT standards, architectures, and request procedures. Deployed MAGTFs may also need to reference pertinent combatant, joint force, and fleet orders, guidance, and IMINT. Tactics, techniques, and procedures are necessary to identify unique operating concepts, methodologies, support procedures, and formats. Marine IMINT plans and orders are prepared by the G-2/S-2 (under the staff lead of the ISC and with the assistance of the other G-2 section and intelligence staff officers and commanders) and the commanding officers/OICs of the supporting IMINT units. The MAGTF IMINT plans and orders appear as appendix 7

of the intelligence annex of the MAGTF OPLAN or OPORD and will focus on internal MAGTF IMINT requirements, operations, and TTP.

Appendix 7 (Imagery Intelligence) to Annex B (Intelligence) to an OPLAN or OPORD will provide detailed planning and direction for conducting MAGTF IMINT operations. The ISC is responsible for its development. It should be prepared consistently with the format outlined in the Joint Operation Planning and Execution System, tailored as necessary to remain consistent with the situation and the particular needs of the MAGTF (see app. K for a sample IMINT operations appendix format). The IMINT operations appendix should include friendly IMINT forces to be used, and the following:

- Personnel augmentation requirements.
- IMINT units of adjacent or other theater forces and support expected.
- Joint force maritime component commander and naval task force/amphibious force IMINT elements that provide support to the landing force in amphibious operations.
- Pertinent IMINT capabilities and support from the JTF headquarters, combatant command's JIOC, and other component commanders/task forces within JTF operations.
- Planned arrangement and employment of external IMINT support, including special collection, production, dissemination, and CIS.
- Establishment of coordinating instructions for the planning and control of IMINT operations, including the technical support expected from higher headquarters.
- Tasking of MAGTF IMINT elements.
- IMINT production, priorities, and plans.
- IMINT dissemination priorities and plans, including CIS support to the MAGTF IMINT effort.
- Equipment/logistic requirements unique to IMINT.

**Imagery Intelligence Planning Considerations in Other Portions of Annex B.** The following are other portions of annex B (in addition to appendix 7) where IMINT is incorporated:

- Appendix 11 (Intelligence Estimate). The format for the intelligence estimate is found in appendix A of MCWP 2-3, *MAGTF Intelligence Production and Analysis*.
- Appendix 14 (Reconnaissance and Surveillance Plan):
  - Tab C (Unmanned Aircraft System Plan) (see app. L).
  - Tab D (Aerial Imagery Plan) (see app. M).
- Appendix 16 (Intelligence Operations Plan):
  - Tab A (Intelligence Collections Plan). The format for the intelligence collection plan is contained in appendix C of MCWP 2-2, *MAGTF Intelligence Collection*.
  - Tab B (Intelligence Production Plan). The format for this plan is found in MCWP 2-3.
  - Tab C (Intelligence Dissemination Plan). The format for this plan is found in MCWP 2-4, *Marine Air-Ground Task Force Intelligence Dissemination*.

- Tab D (Intelligence Communications). The format for this tab is found in MCWP 2-4.
- Tab E (Intelligence Reports). The format for this tab is found in MCWP 2-3.
- Appendix 17 (Support to Survival, Evasion, Resistance, and Escape—SERE).

# CHAPTER 6

## TRAINING

The HQMC-Imagery and Geospatial Intelligence Branch—through the Training and Education Command and Marine Corps Intelligence Schools Command—is responsible for implementing and maintaining GEOINT training and education programs. Unit training plans should cover imagery, imagery platforms and sensors, GEOINT data types, post-processing techniques, collections, software, hardware, established and emerging dissemination techniques, production management, and full spectrum geospatial intelligence.

---

### IMAGERY TRAINING

The leadership within each imagery, FMV, and MTI section is responsible to both the Marine Corps Intelligence 0241 occupational field and unit commanding officer for implementing training requirements.

#### Requirements

Initial training for all IMINT specialists (MOS 0241) is conducted via the tactical imagery analysis course, which is operationally supported by The National Geospatial-Intelligence College located at Fort Belvoir, Virginia. Administrative support for the tactical imagery analysis course is provided by the Marine detachment, Fort Belvoir and Marine Corps Intelligence School. The HQMC-Intelligence Manpower and Training Branch, in conjunction with the occupational field monitor and sponsor, manages student assignments to the operating forces as well as orders to many of the follow-on and advanced training courses.

#### Training Objectives

Entry-level, intermediate, and advanced training for MAGTF IMINT specialists should include—

- Joint and Marine Corps GEOINT doctrine.
- IC, DOD, and Marine Corps intelligence structure and policies.
- FMV platforms, sensors, and exploitation systems.
- MTI platforms, sensors, and exploitation systems.
- Strategic, theater, organic, and commercial imagery platforms and sensors.
- DOD and Marine Corps imagery exploitation networks, systems, hardware, and software, as well as basic system administration.
- Identification of tactical orders-of-battle.
- Report writing and dissemination systems.
- Support to MAGTF through imagery and IMINT products.

- Exploitation techniques to extract EEIs.
- Tools for discovery, retrieval, and exploitation of imagery and geospatial data.
- Littoral studies in support of amphibious operations.
- LZ studies in support of fixed- and rotary-wing MAGTF assets.
- LOC studies in support of MAGTF assets.
- JP 2-01.3, *Joint Intelligence Preparation of the Operational Environment*.
- Research of intelligence and information.
- GEOINT collaboration with GIS and METOC elements of the MAGTF.

### **Planning and Employment Training**

Planning and employment training is essential to preparing the IMINT specialist for intelligence operations in support of the MAGTF. This training provides—

- Familiarity with the nuances of setting up and configuring equipment for use on classified networks.
- Firsthand experience operating within the systems' constraints created by an expeditionary environment.
- Understanding of when and how to adjust production workflows in order to fulfill the MAGTF commander's intelligence requirements.

**System Administration Training.** During the tactical imagery analysis course, Marines receive basic system administration training on the TEG FoS. Subsequent formal/managed on-the-job training (MOJT) is needed to ensure analysts have a working knowledge of equipment set up, configuration, utilization, and tear down in austere environments. Each unit should establish its own training cycle to develop and enhance system administration proficiency.

**Maintenance Training.** Organizational level maintenance of imagery exploitation hardware and software enables the analyst to ensure the unhindered continuation of production workflows and dissemination of completed IMINT studies when systems experience technical difficulties. A significant number of interruptions to the intelligence cycle can be mitigated through user-level familiarity with hardware and software, because the analyst will not need to consult maintenance echelons for assistance. User-level troubleshooting should include a general emphasis on finding alternate means of gathering data and exploiting and disseminating imagery and IMINT studies when primary methods are unavailable.

**Database Management Training.** Imagery production elements require significant amounts of storage space on local and network servers. The proper management of these storage elements—including directory structure, proper data archive, and production workflows—ensures production cycles are not hindered by server failures and assists in federated production and collaboration through centrally located and properly managed working files.

### **MAGTF Training**

Imagery and IMINT production is incorporated into all MAGTF training. During training exercises, imagery operations should be conducted under a variety of C2 support relationships to improve organizational and employment flexibility. Repeated exposure to imagery capabilities



and employment strategies will enhance the MAGTF's ability to use imagery and IMINT effectively to increase situational awareness and shape operations.

**Command Post Exercise/Staff Exercise.** The production and use of imagery should be included in every exercise. Training exercises should emphasize the planning of imagery support requirements and production procedures, the dissemination of imagery within MAGTF Marine Corps enterprise network systems, and the use of imagery within the MCPP. The unit intelligence officer should use the planning cycle and develop a realistic imagery production plan. Imagery intelligence analysts should be assigned to the exercise control group in order to validate the planning and production plan and to simulate the dissemination of mission-specific data from national and theater production facilities.

**Field Training Exercise.** Field training exercises may be used to introduce IMINT analysts to exploitation procedures within the MAGTF IOC. Additionally, a field training exercise provides an operational context in which to integrate, intensify, produce, and disseminate tailored mission-specific data sets in support of C2, intelligence, fire support, aviation, logistic, and maneuver operations. The imagery section should coordinate with staffs and units at all echelons of command. Interaction helps to increase the supported organization's understanding of imagery in general and the capabilities afforded by imagery and IMINT.

---

## TRAINING COURSES

Basic- and advanced-level imagery training programs are available at National Geospatial-Intelligence Agency College. Alternative education imagery programs include correspondence courses, distance courses, and contractor or vendor supported training.

### **Basic-Level: Tactical Imagery Analysis Course**

Active duty students in the tactical imagery analysis course are traditionally sergeants or senior corporals. Reservists are typically privates through sergeants. The tactical imagery analysis course is divided into 10 annexes and spans 91 training days (approximately 5 months). Each annex includes multiple graded events and ends with a comprehensive phase completion exercise during which students employ all skills taught within that annex as follows:

- Annex A: information assurance, classification procedures, intelligence doctrine, operations, maps/charts, intelligence writing, and impromptu briefing.
- Annex B: principles of imagery interpretation, sensor phenomenology, imagery platforms, the ATO, and collections.
- Annex C: identification of orders of battle and facilities.
- Annex D: research techniques and tools, use of software for production, symbology, and cross-referencing geographic locations between various data sources.
- Annex E: production techniques for extracting, analyzing, and annotating completed intelligence studies.
- Annex F: an introduction to full spectrum GEOINT and critical thinking.

- Annex G: dissemination methods.
- Annex H: imagery reports and briefs.
- Annex I: setup, basic systems administration, and teardown of the current imagery exploitation workstation.
- Annex J: the capstone exercise to familiarize the students with operating in a MAGTF IOC.

### **Intermediate- and Advanced-Level Training**

Intermediate- and advanced-level training is available in various skill areas by multiple government and nongovernment entities. Unit training managers should determine the most effective method of training for ensuring that IMINT analysts are properly prepared to meet mission requirements.

**Government and Nongovernment Training Sources.** The following list contains government and nongovernment training sources:

- Federal agencies.
- DOD agencies.
- Services.
- Corporations.
- Base education centers.
- Colleges and universities.

**Delivery Methods for Training.** The following list contains delivery methods for training:

- Resident courses/formal schools.
- Primer courses.
- Mobile training teams.
- Computer-based training.
- Web-based training.
- Distance courses.
- MOJT.

**Training Considerations.** Since the majority of follow-on training is provided by organizations outside of the Marine Corps, leadership of imagery sections must ensure that their analysts are able to integrate these tactics and techniques into the MAGTF mission using existing methods while following established or emerging Marine Corps intelligence doctrine and operational concepts. Training managers are also responsible for ensuring that the knowledge and experience gained through training supports the unit mission and the Marine Corps mission by considering the following:

- Special hardware or software to make use of advanced exploitation techniques.
- Classification and releasability.

**Training Entities.** Creative utilization of available training resources ensures the individual analyst, unit, and occupational field are prepared to support the MAGTF mission. Funding and unit mission should be carefully scrutinized and training managers should ensure training dollars are spent on the most qualified and deserving analysts. Training is available from the following resources:

- National Geospatial-Intelligence Agency College.
- Joint Intelligence Virtual University.
- National Defense Intelligence College.
- Software vendors.
- Hardware vendors.

### **Follow-On Training Subject Areas**

The subject areas discussed in the following subparagraphs should be considered essential to the continued development of individual analysts and MOS 0241 by training managers.

**Marine Corps and Joint Intelligence Doctrine.** Doctrine provides analysts with an established reference for joint and MAGTF procedures and operations; moreover, knowledge of doctrine prepares the analyst to anticipate the MAGTF commander's needs. This doctrine facilitates greater speed and focus of analytical effort and, when coupled with knowledge of the enemy, facilitates predictive analysis.

**Intelligence Writing.** The ability to communicate the numerous pieces of information and intelligence on written reports is a skill needed by all intelligence analysts. Completed imagery and IMINT studies can often be difficult to disseminate due to network constraints and may need to be supplemented by textual reports.

**Imagery and Imagery Intelligence Production.** Repetition provides analysts with an intimate working knowledge of production techniques, procedures, timelines, software operation, and hardware operation; builds analytical efficiency; and equips analysts with the necessary skills to operate autonomously. Unit training events, MOJT, exercises, and real world production scenarios should be utilized to develop the analytical processes that consistently produce the necessary results, as well as develop the analytical mind that can effectively advise the MAGTF commander on proper utilization of imagery production assets.

**Imagery, Imagery Intelligence, and Geospatial Intelligence Data.** Imagery intelligence analysts need a thorough knowledge of the differences in data types, uses, and special handling issues. This knowledge enables analysts to integrate other data sets quickly into production workflows and generate IMINT and GEOINT products and reports in support of operations. Analysts should be familiar with software operating files, hardware operating files, imagery files, and the differences between each; post-processed data file types; and any other files they will commonly utilize in accomplishment of the mission.

**Imagery, Imagery Intelligence, and Geospatial Intelligence Databases.** The proper storage of both raw data and finished intelligence products is essential. Analysts must be able to configure servers

properly for use on exploitation networks, manually and semi-manually store information and IMINT studies, and archive data.

**Spectral Exploitation and Spectral Systems.** Basic and advanced training in analysis of spectral data is designed to provide students with a deeper understanding of spectral imagery processing as well as literal and nonliteral spectral imagery analysis techniques. Multispectral and hyperspectral imagery exploitation and processing techniques should be covered. Familiarity with essential software and plug-ins for exploitation are also essential to exploitation.

**Commercial Imagery.** Marines must understand proper copyright procedures, as well as how licensing affects the dissemination of commercial imagery and data outside of licensed users. This knowledge impacts the ability of the Marine Corps to do the following:

- Share data with various governments, agencies, nongovernmental organizations, and personnel during MAGTF operations, which can often be hindered by security classifications.
- Research, retrieve, properly exploit, and disseminate commercial data available to DOD entities, which is essential to these operations.

**Airborne Imagery.** The understanding of strategic, theater, and tactical airborne platforms, sensors, and data, as well as how to gain access to airborne libraries greatly increases the data available to the imagery analyst for exploitation.

**Motion Imagery.** Reliance on FMV for persistent ISR has continued to grow within the Marine Corps and DOD. Knowledge of UASs and their associated systems provides analysts with the necessary skills to manage the tasking, processing, exploitation, and dissemination process.

**Moving Target Indicator.** Training in the use of MTI data and systems to support the MAGTF is accomplished via formal schooling. Basic analysts should possess familiarity with raw MTI data, exploitation hardware and software, completed products, and processes in order to facilitate collaboration.

**Synthetic Aperture Radar.** Training in the use of MTI data and systems to support the MAGTF is accomplished via intermediate training based at a government facility or provided directly to the unit. The MTI operator training course will supply MOSs 0231 and 0241 with MTI fundamentals, hardware and software setup and configuration, exploitation tools, product development, and various MTI support missions.

**Advanced Phenomenologies and Imagery Techniques.** Formal training in the software, techniques, and releasability of thermal infrared imagery, polarimetric imagery, and overhead persistent infrared is essential to ensuring analysts can seamlessly integrate solutions into MAGTF intelligence problems. Familiarity with essential software and plug-ins for exploitation is also essential to exploitation.

**Foreign Disclosure.** Marines must be familiar with foreign disclosure procedures. Military information is a national security asset that must be conserved and protected. It may be shared with foreign representatives only when there is a clearly defined advantage to the United States.

Only designated foreign disclosure officers may approve of the disclosure of classified and controlled unclassified military information to foreign representatives. The Secretary of the Navy Manual, *Department of the Navy Foreign Disclosure Manual*, and MCO 5510.20B, *Disclosure of Military Information to Foreign Governments and Interests*, are two of the many references which should be reviewed and understood.

**Imagery Classification Marking.** While it is important that the public be informed concerning the activities of its government, certain information concerning the national defense and foreign relations must be protected against unauthorized disclosure. This information is called national security information and is classified if its disclosure might cause damage to the nation's security. Marines must be aware of the rules regarding classification of the imagery products they produce as well as those produced by other courses. Executive Order 13526, *Classified National Security Information*, and Executive Order 12951, *Release of Imagery Acquired by Space-Based National Intelligence Reconnaissance Systems*, are just two of the references on classified material.

**Full Spectrum Geospatial Intelligence.** Full spectrum geospatial intelligence, also known as imagery-derived MASINT, includes all types of information technically derived from the processing, exploitation, and nonliteral analysis (including integration or fusion) of spectral, spatial, temporal, radiometric, phase history, and polarimetric data. These types of data can be collected on both stationary and moving targets by electro-optical, infrared, radar, and related sensor programs (both active and passive).

# APPENDIX A

## IMAGING SENSORS

This appendix describes the basic capabilities and limitations of EO, radar, and infrared imagery sensors.

---

### OPTICAL SENSORS

Optical sensors detect and record electromagnetic radiation within the visible light and near-infrared portions of the electromagnetic spectrum. The operating principles are the same as those of a common digital camera. There are three types of optical imaging systems: vertical, oblique, and panoramic.

#### Vertical

The optical axis of the sensor is approximately perpendicular to the surface of the earth (see fig. A-1). Vertical imagery is ideal for performing terrain analysis, beach studies, and HLZ studies.

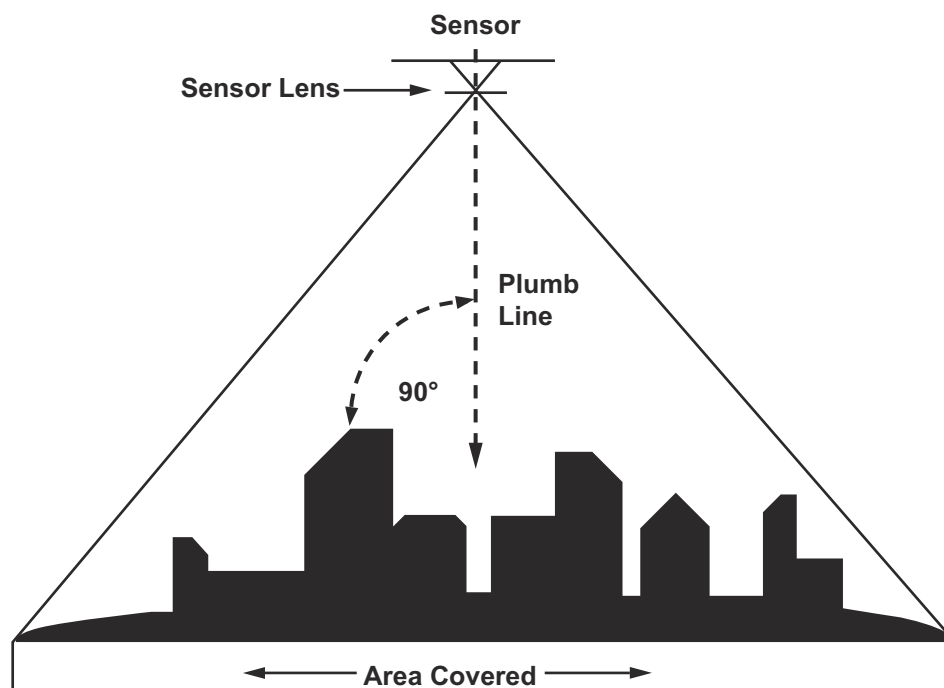

Figure A-1. Vertical Optical Sensor and Ground Relationship.

## Oblique

Oblique imagery is obtained by imaging the ground at an angle to the vertical and requires oblique metrics. The optical axis of the sensor is intentionally directed between the horizontal and the vertical. This axis can provide left or right oblique coverage and is ideal for observation at canopy baseline as well.

There are two standard types of oblique imagery: high and low. High oblique imagery will include the horizon (see fig. A-2), while low oblique imagery will not (see fig. A-3). Because of the angle, high oblique imagery covers a larger area than low oblique. Oblique imagery is referred to as left or right oblique or forward looking, based on the look angle in relation to the platform.

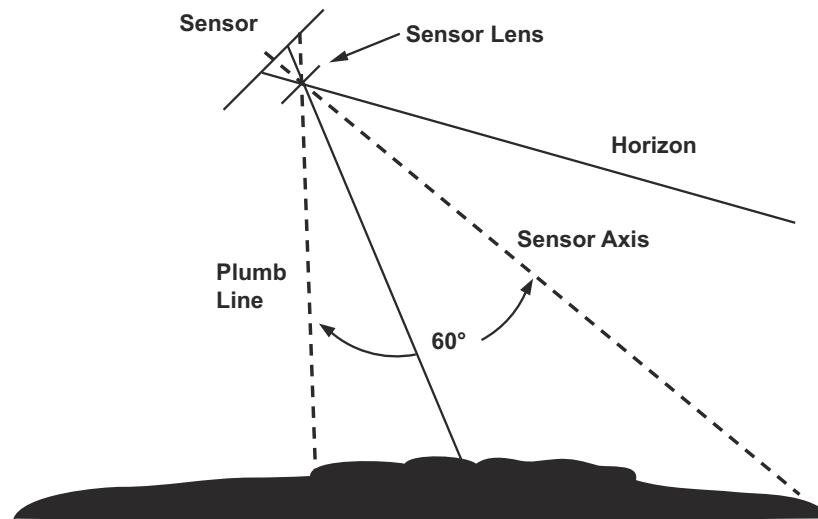

Figure A-2. High Oblique Sensor to Ground Relationship.

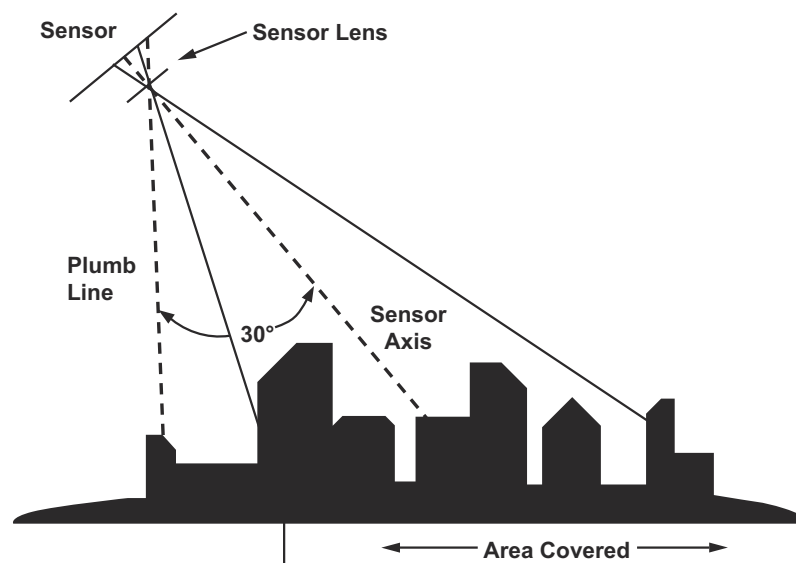

Figure A-3. Low Oblique Sensor to Ground Relationship.

## Panoramic

Panoramic imagery is taken with a special sensor that scans a wide area. The optical axis of the sensor uses a system of optics that can scan an area from 0 to 180 degrees. There are two types of panoramic imagery: low and high. Low panoramic imagery is taken at low altitudes and scans a wide angle that includes the horizon at either side of the aircraft flight path (see fig. A-4).

High panoramic imagery is taken at high altitudes with a narrow scan angle (see fig. A-5). The horizon is not normally visible on high panoramic imagery.

In only one pass over the target area, panoramic photography provides coverage of large areas of terrain on both sides of the aircraft flight path. Although it provides both vertical and oblique views of the image area, it is the most difficult and time-consuming photography to analyze and measure due to the distortion of the recorded image. Table A-1, on page A-4, summarizes both the advantages and disadvantages of each type of imaging system.

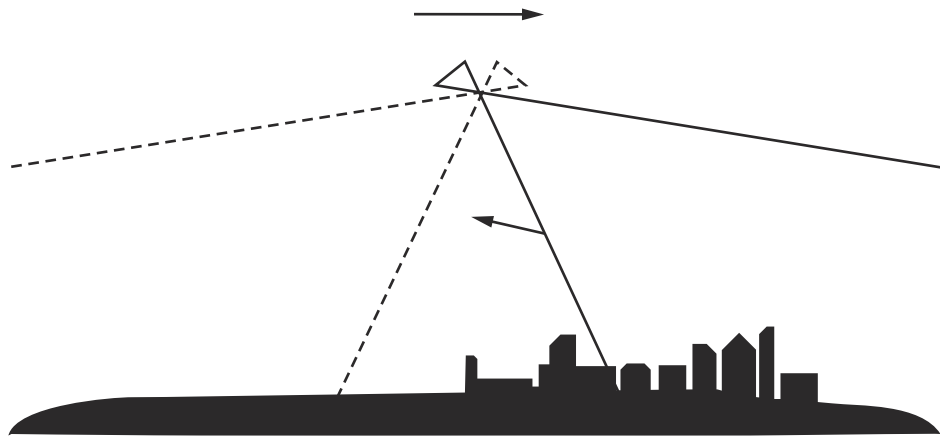

Figure A-4. Low Panoramic Imagery.

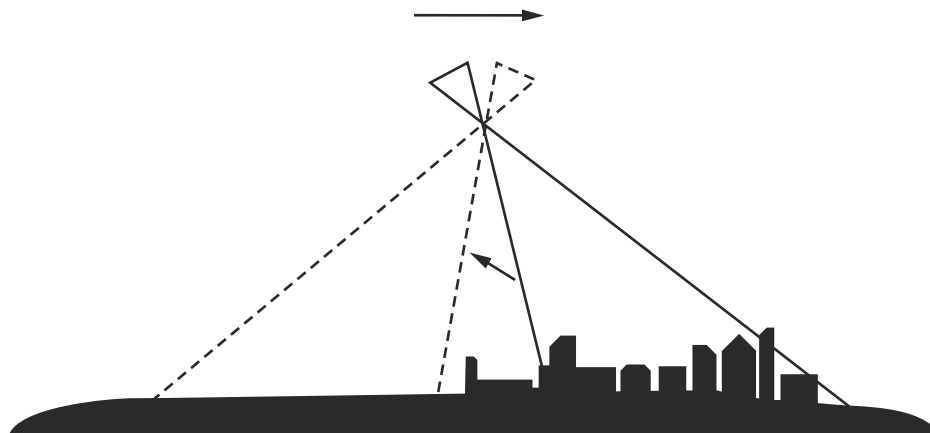

Figure A-5. High Panoramic Imagery.



**Table A-1. Optical Sensor Advantages and Disadvantage.**

Sensor System	Advantages	Disadvantages
<b>Vertical</b>	Provides fairly constant scale Can construct mosaics Obtains accurate measurements Allows stereographic viewing Allows for accurate interpretation	Flight path is directly over the target Covered objects cannot be viewed View angle is unnatural It is susceptible to flight restrictions
<b>Oblique</b>	Provides large area coverage Provides natural view Offsets flight path from target Allows for covered objects viewing, due to angle	Terrain masking Scale varies Measurements are difficult
<b>Panoramic</b>	Provides large area coverage Satisfies both vertical and oblique mission requirements	Scale varies Platform has limited standoff capability Measurements are difficult

The capabilities of optical sensors are as follows:

- They produce high-quality photographs (good resolution).
- They are a passive system, which cannot be detected or jammed.
- Their sensors offer flexibility.

The limitations of optical sensors are as follows:

- They require a light source.
- They are hampered during periods of reduced visibility.
- They are LOS dependent.

### **Radar**

Radar is an active sensing technique that detects and records differences in reflected electromagnetic energy. The capabilities of radar are as follows:

- It can be used for day and night operations.
- It provides all-weather capability.
- It provides constant scale and resolution.
- It provides standoff capability.

The limitations of radar are as follows:

- It provides poor resolution.
- It is an active system, which can be detected or jammed.
- It is LOS dependent.

## **Infrared**

Infrared sensors detect and record electromagnetic radiation that is emitted from a given target surface in the infrared portion of the electromagnetic spectrum. The capabilities of infrared are as follows:

- It can be used for day and night operations.
- It is a passive system, which cannot be detected or jammed.
- It detects camouflaged equipment and activity.

The limitations of infrared are as follows:

- It offers poor resolution, when compared to EO imagery.
- It is susceptible to adversary deception.
- It is not all-weather; it is hampered by such disturbances as rain, snow, or hail.
- It is LOS dependent.

# APPENDIX B

## IMAGERY AND SUPPORTING INTELLIGENCE REPORTS

This appendix provides examples of MAGTF intelligence products that are derived from the fusion of available imagery. Such products support IMINT and all-source intelligence reports, tactical planning, and decisionmaking. The examples and formulas in this appendix are provided to aid in the preparation of imagery and supporting intelligence products and studies. They are meant to be used as general guides for these types of products and not to replace or supersede any products being developed in accordance with local SOPs. Additionally, the MCIAC maintains a set of instructions distributed across the Marine Corps for imagery analysts including all of the material provided herein.

Examples of imagery products included in this publication are as follow:

- Image and supporting intelligence report for the military operations on urbanized terrain (MOUT) facility, Camp Lejeune, North Carolina.
- Image and supporting intelligence report for the Marine Corps Air Station, New River, North Carolina.
- Image and supporting intelligence report for HLZ Vulture, Camp Lejeune, North Carolina. Image and supporting intelligence report for Onslow Beach North, Camp Lejeune, North Carolina.
- Image and supporting intelligence report for Kin Red Beach, Okinawa, Japan.

#### Legend for Appendix B:

DMA—Defense Mapping Agency  
GEO—geographic coordinate  
JLOTS—joint logistics over-the-shore  
LCAC—landing craft air cushion  
MIM—military installation map  
MPF—maritime prepositioning force  
NAD—North American datum  
nm—nautical miles  
No—number  
OP-2—Outpost 2  
RO/RO—roll on/roll off  
STD—standard  
WGS—World Geodetic System

Urban Imagery Product Example: Image and Supporting Intelligence Report  
for the Military Operations on Urbanized Terrain Facility, Camp Lejeune, North Carolina



**Center Coordinates**

UTM: 18STD93843838  
GEO: 343959N0771459W

**Size**

Length: 1,025 ft (312 m)  
Width: 800 ft (244 m)

**Surface Material**

Silty sand  
Gravel

**Map Reference**

Sheet: Camp Lejeune MIM  
Series: V742S  
Edition: 2-DMA  
Datum: NAD 83/WGS 84

**Remarks**

The MOUT facility is located approximately 2 km east-north-east of OP-2. The primary use of the MOUT facility is combat training in an urban environment. The MOUT facility consists of 31 buildings of varying sizes and shapes. Roof types are a mixture of garbled and flat. The facility is surrounded by trees of varying heights. The exit from the MOUT facility is a loose surface road which provides access to Lyman Road.

*Note:* All building measurements are listed as length x width x height.

Anno. #	Type	Exits		Width	Surface Material
		True Bearing	Distance		
E1	Road, loose-surfaced	146	169.8 m (557 ft)	7.6 m (25 ft)	Earth and sand
E2	Road, loose-surfaced	175	163.1 m (535 ft)	6.4 m (21 ft)	Earth and sand
E3	Road, loose-surfaced	181	165.0 m (541 ft)	6.7 m (22 ft)	Earth and sand
E4	Road, loose-surfaced	281	204.3 m (670 ft)	5.6 m (18 ft)	Earth and sand

Descriptions of the buildings shown in figure B-1 are as follows:

B1. Three-story, 120 ft x 58 ft x 37 ft (37 m x 18 m x 11 m), T-shaped building (hotel), with near-flat roof. A helicopter landing point (LP) is painted with non-reflective white airfield markings and consists of a concrete slab roof. The helicopter landing point is 38 ft x 33 ft (12 m x 10 m). The building's roof is outlined by a parapet with scuppers and a gutter. (A scupper is an opening in the wall of a building through which water can drain). The front portion of the roof consists of tube trusses or transverse monitors. Grappling and rappelling anchors are located at points throughout the roof.

B2. Two-story, 72 ft x 60 ft x 31 ft (22 m x 18 m x 9 m), square-shaped building (city hall), consisting of a near-flat roof outlined by a parapet; however, the northwest corner is lower than the main roof. The roof has grappling and rappelling anchors at points throughout the roof. The corner of the roof is open to a crawl space.

B3, B4. Two-story, crescent-shaped buildings (apartments), with an outer edge measuring 121 ft x 60 ft x 31 ft (37 m x 18 m x 9 m), and an inner edge measuring 84 ft x 60 ft x 31 ft (26 m x 18 m x 9 m), outlined by a parapet with scuppers. Grappling and rappelling anchors are located at points throughout the roofs. The roofs are near flat with a ridge dissecting each building, and a near-flat roof dissected by a ridge separates the two buildings.

B5. Three-story, 72 ft x 36 ft x 38 ft (22 m x 11 m x 12 m), quasi-rectangular-shaped building (office). Grappling and rappelling anchors located on the southeast and northwest sides of roof. The southern end of the building is two stories, 23 ft (7 m) high. An elevator shaft is located in the center of the roof.

B6. Two-story, 44 ft x 36 ft x 25 ft (13 m x 11 m x 8 m), L-shaped building (office). The northwest portion of the roof is a concrete slab.

B7. Rectangular, 121 ft x 73 ft x 77 ft (37 x 22 x 23 m), T-shaped building with dormers (church) with a gable roof made of asphalt and fiberglass shingles. The height of the main building is 48 ft (15 m), the steeple is 29 ft (9 m).

B8. Three-story, 53 ft x 34 ft x 39 ft (16 m x 10 m x 12 m), irregular-shaped building (business/residential) with near-flat roof. Grappling and rappelling anchors are located at points throughout the roof.

B9. Three-story, 50 ft x 47 ft x 39 ft (15 m x 14 m x 12 m), irregular-shaped building (business/residential) with near-flat roof.

B10. Single-story, 128 ft x 46 ft x 18 ft (39 m x 14 m x 5 m), rectangular-shaped building (business/residential) with flat roof.

B11. Two-story, 103 ft x 53 ft x 30 ft (31 m x 16 m x 9 m), rectangular-shaped building (townhouse) that has a gable roof with a dormer. The roof consists of fiberglass shingles reinforced by wooden trusses.

B12. Two-story, 103 ft x 53 ft x 30 ft (31 m x 16 m x 9 m), rectangular-shaped building (townhouse). The front and rear portions of the building's walls are incomplete. It has a gable-roofed dormer with fiberglass shingles and reinforced wooden trusses.

B13, B14. Two-story, 103 ft x 53 ft x 30 ft (31 m x 16 m x 9 m), rectangular-shaped buildings (townhouses) with gable roof and dormers. The roof consists of fiberglass shingles reinforced with wooden trusses.

B15. Two-story, 88 ft x 73 ft x 25 ft (27 m x 22 m x 18 m), irregular-shaped building (school) with near-flat roof built on a 2-inch slab of concrete. Rappelling anchors are located at points throughout the roof. Two fire escape ladders are located on the northeast and southwest sides of the roof.

B16. Two-story, 128 ft x 74 ft x 25 ft (38 m x 23 m x 8 m), irregular-shaped building (gymnasium) with a near flat roof. Fire escape ladders are located on the south side of the building.

B17. Two-story, 43 ft x 36 ft x 26 ft (13 m x 11 m x 8 m), square-shaped building (retail bank) with a near-flat roof. Grappling anchors located at points throughout the roof. Roof access by ladder is located on the northwest corner of the building.

B18. Single-story, 74 ft x 32 ft x 17 ft (23 x 10 x 5 m), quasi-rectangular-shaped building with hipped roofs (service stations).

B19. Single-story, 63 ft x 43 ft x 23 ft (19 m x 13 m x 7 m), rectangular-shaped building (warehouse) with a near-flat roof. The roof consists of standing seam metal on metal purloins. (Purloins are horizontal timbers supporting the rafters of a roof.)

B20. Single-story, 83 ft x 63 ft x 25 ft (25 m x 19 m x 8 m), square-shaped building (warehouse) with a near-flat roof on metal purloins and a mezzanine. (A mezzanine is an intermediate floor between two main floors of a building.)

B21, B22. Single-story, 52 ft x 40 ft x 15 ft (16 m x 12 m x 5 m), T-shaped buildings with basements (residential). The gable-style roof is reinforced with wooden trusses. The chimney height extends 2 ft (.6 m) above the peak of the roof.

B23, B24, B26. Single-story, 52 ft x 40 ft x 15 ft (16 m x 12 m x 5 m), T-shaped buildings (residential) with gable style roof reinforced with wood trusses. Chimney extends 2 ft (.6 m) above peak.

B25. Residential, 52 ft x 40 ft x 15 ft (16 m x 12 m x 5 m), irregular-shaped building with a gable-style roof reinforced with wood trusses.

B27, B28. Single-story, 44 ft x 40 ft x 17 ft (13 m x 12 m x 5 m), T-shaped buildings (residential) with reinforced wooden trusses. The gable roofing consists of fiberglass shingles.

B29, B30. Small, 44 ft x 40 ft x varies (13 m x 12 m x varies), T-shaped buildings, nearly destroyed; may provide some shelter from direct fire.

**Airfield Product Example: Image and Supporting Intelligence  
Report for the Marine Corps Air Station, New River, North Carolina**



**Center Coordinates**  
 UTM: 18STD76354355  
 GEO:  
 344233N0772631W  
 Elevation: 25 ft (8 m)

**Map Reference**  
 Sheet: Camp Lejeune  
 MIM  
 Series: V742S  
 Edition: 2-DMA

**Runways**

No.	Magnetic Bearing	Length	Width	Surface Material	Capability
R1	50/230	5,098 ft (1,554 m)	150 ft (46 m)	Asphalt	C-141
R2	10/190	5,075 ft (1,547 m)	150 ft (46 m)	Asphalt	C-130

**Taxiways**

No.	Length	Width	Surface Material	Type	Remarks
T1	775 ft (236 m)	25 ft (8 m)	Asphalt	Link	Connects to P4 to R1 and R2
T2	1,850 ft (564 m)	38 ft (11 m)	Asphalt	Link	Connects R1 and R2 to T3
T3	3,500 ft (1,066 m)	107 ft (33 m)	Asphalt	Link	Connects R1 and R2 to P3
T4	718 ft (219 m)	55 ft (17 m)	Asphalt	Link	Connects R1 to P2
T5	2,500 ft (762 m)	53 ft (16 m)	Asphalt	Link	Connects P2 to P3 and P4

**Parking Areas**

<b>No.</b>	<b>Length</b>	<b>Width</b>	<b>Surface Material</b>
P1	582 ft (177 m)	263 ft (80 m)	Concrete
P2	1,328 ft (405 m)	894 ft (272 m)	Concrete
P3	1,388 ft (423 m)	973 ft (297 m)	Concrete
P4	3,144 ft (958 m)	1,222 ft (372 m)	Concrete

**Remarks**

Marine Corps Air Station, New River is bordered on the east by New River and on the southwest by Southwest Creek. Trees and buildings of various heights surround the airfield.



Helicopter Landing Zone Study Example: Image and Supporting Intelligence Report for Helicopter Landing Zone Vulture, Camp Lejeune, North Carolina



**Center Coordinates**  
 UTM: 18STD76123004  
 GEO: 343516N0772627W

**Map Reference**  
 Sheet: Camp Lejeune MIM  
 Series: V742S  
 Edition: 2-DMA  
 Datum: NAD 83/WGS 84

HLZ Shape	HLZ Type	Surface Material	HLZ Size
Irregular	Open Field	Scrub Grass	Length: 1,209 ft (369 m) Width: 215 ft (66 m)

**Exits**

No.	Type	Distance and Grid	
		Azimuth from HLZ Center	Width
E1	Loose surface road	182 ft (55 m) 280°	20 ft (6 m)

**Flight Hazard**

No.	Type	Height and Grid Azimuth to HLZ Center
See remarks		

**Remarks**

The HLZ is located 600 m south of stone bay rifle range. E1 exits the HLZ on the west side extending north on Booker Washington Boulevard to the rifle range or west to range road. The western perimeter of the HLZ has four buildings that may present flight hazards. The HLZ is surrounded on the north, south, and east sides by trees of varying height that may constitute flight hazards to low-flying aircraft. Blowing sand and debris caused by rotor wash may produce flight hazards. Adjacent terrain consists of a dissected plain, vegetated with trees and brush.

**Beach Study Example: Image and Supporting  
Intelligence Report for Onslow Beach North, Camp Lejeune, North Carolina**



Sheet: Camp Lejeune MIM  
Series: V742S  
Edition: 2-DMA  
Datum: NAD 83/WGS 84

Left Flank	Beach Center	Right Flank
UTM: 18STD90132636	UTM: 18STD90702680	UTM: 18STD93032730
GEO: 343327N0771714	GEO: 343341N0771636	GEO: 343354N0771633W

**Length**  
Total: 1,393.4 m (4,752 ft) average backshore  
Usable: 1,373.1 m (4,505 ft) visible foreshore

**Width**  
Width: 66.4 m (218 ft)  
Width: 24.0 m (79 ft)

**Surface Material**  
Nearshore: sand and mud  
  
Foreshore: sand  
  
Backshore: sand

**Trafficability**  
Personnel:  
dry—good  
wet—fair  
Wheeled:  
dry—good  
wet—fair  
Tracked:  
dry—good  
wet—fair

**Tides**

Tidal type: diurnal                      Average beach gradient: 1:116                      Matting recommended: yes  
 Tidal range: 1.0 m (3 ft)                      Firmness: firm when wet  
 MFP capable: no; see remarks.                      JLOTS capable: no; see remarks.                      LCAC offload capable: yes; see remarks.

**Location:** Onslow Beach North is approximately 13.1 km (7.1 nm) south-southeast of the US Embassy. It is 3.7 km (2.0 nm) east-northeast of HLZ Bluebird and 1.4 km (0.8 nm) east-southeast of HLZ Albatross.

**Characteristics remarks:** Onslow Beach North is not MPF-capable since there is no MPF-capable port within 92.7 km (50 nm) of the beach. It is not JLOTS-capable due to insufficient beach gradient. It is, however, LCAC offload-capable due to average backshore width of 66.4 m (218 ft). All coordinates provided in this report were derived from the 1:50,000 scale map sheet listed in the reference above. All measurements were derived by MEF imagery analysts from mensurated imagery.

**Obstructions**

Anno. #	Type	True Bearing	Distance	Length	Width
N1	Pier	225	542.0 m (1,778 ft)	20.3 m (67 ft)	4.5 m (15 ft)

**Obstruction remarks:** None

**Exit remarks:** Cross-country to partial cross-country exits are available along the entire beach. These exits are too numerous to list individually. Parallel to the beach is a road that extends 6.3 km (3.4 nm) southwest to New River Inlet and 1.4 km (0.8 nm) northeast to Onslow Beach Road which leads approximately 2.8 km (1.5 nm) north-northeast to Highway 172. There are several buildings and compounds in the hinterland along the road.

Beach Study Example: Image and Supporting Intelligence Report for Kin Red Beach, Okinawa, Japan

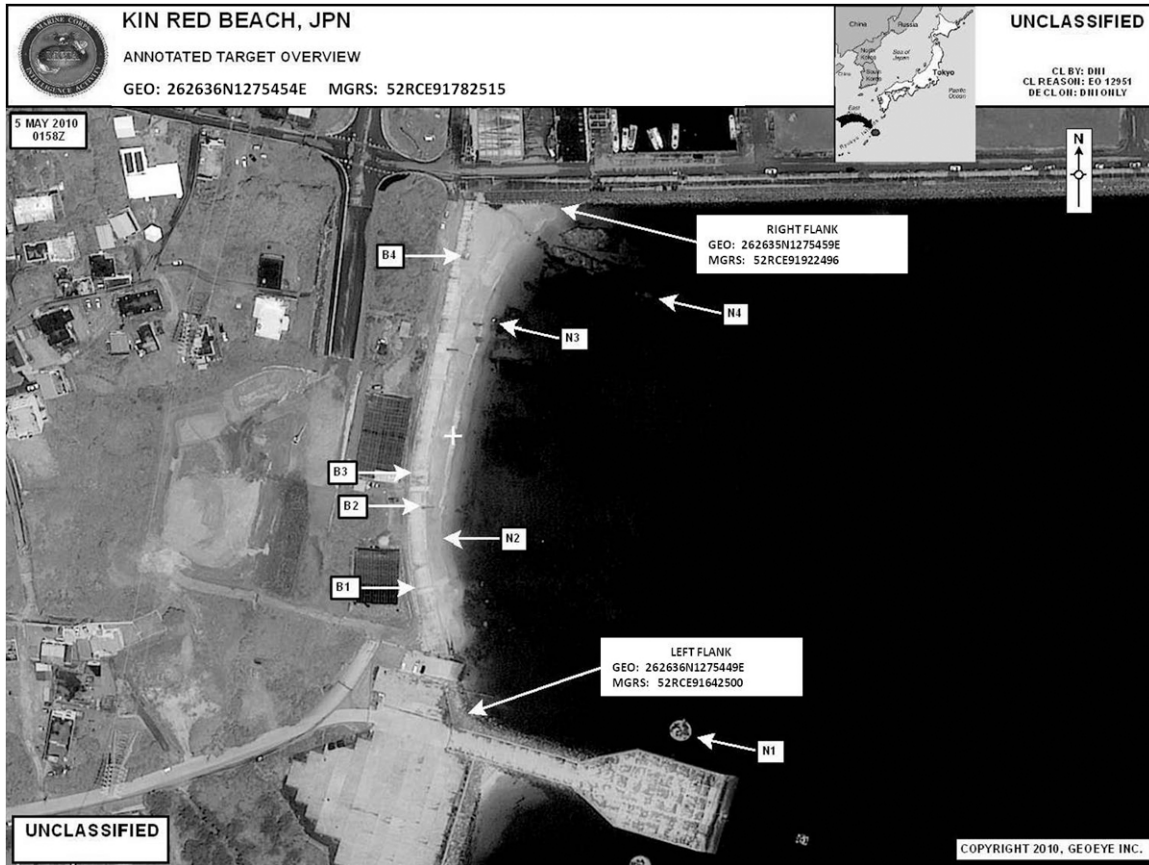

Sheet: Kin Red MIM  
 Series: V742S  
 Edition: 1-DMA  
 Datum: NAD 83/WGS

Left Flank	Beach Center	Right Flank
UTM: 52RCE91642500	UTM: 52RCE91782515	UTM: 52RCE91922496
GEO: 262636N1275449E	GEO: 262636N1275454E	GEO: 262635N1275459E

Shape: straight

**Length**

Total: 274 m (899 ft) average backshore  
 Usable: 151 m (496 ft) visible foreshore

**Width**

width: 16.4 m (218 ft)  
 width: 24.0 m (79 ft)

**Surface Material**

Nearshore: sand/coral  
  
 Foreshore: sand/coral  
  
 Backshore: sand

**Trafficability**

Personnel:  
 wet—good  
 dry—fair  
  
 Wheeled:  
 wet—good  
 dry—fair  
  
 Tracked:  
 wet—fair  
 dry—poor

**Tides**

Tidal type: mixed                      Average beach gradient: 1:116      Matting recommended: yes  
 Tidal range: 1.7 m (5.6 ft)          Firmness: firm when wet

**Location and general remarks:** Kin Red Beach is located 17.6 km northeast of Kadena Airfield. Four islands obstruct the mouth of Kin Bay. The beach is flanked by a RO/RO pier to the west and a breakwater to the east. There are intermittent streams that cross the beach that could hinder lateral movement during inundation. Personnel exit via cross-country along the entire beach length. The beach is backed by a concrete stepped seawall (B4) that severely restricts tracked vehicle and prevents wheeled vehicle movement. The town of Kin Cho further hinders and channels movement from the beach. Hinterland consists of hills covered with dense vegetation of varying heights, cultivated fields, numerous urban areas and/or tombs.

**Obstructions**

Anno. #	Type	True Bearing	Distance	Length	Width
N1	Dolphin	226	157 m (515 ft)	3 m (10 ft)	3 m (10 ft)
N2	Coral	250	86 m (282 ft)	18 m (59 ft)	20 m (66 ft)
N3	Coral	090	46 m (150 ft)	32 m (105 ft)	12 m (39 ft)
N4	Coral	113	92 m (302 ft)	40 m (131 ft)	32 m (105 ft)
B1	Coral	261	94 m (308 ft)	8 m (26 ft)	7 m (23 ft)
B2	Coral	270	26 m (85 ft)	14 m (46 ft)	9 m (30 ft)
B3	Coral	077	51 m (167 ft)	16 m (52 ft)	13 m (43 ft)
B4	Seawall	270-070	Varies	270 m (886 ft)	9 m (30 ft)

**Obstruction remarks:** Obstructions are measured from the beach center to the obstruction.

**Exit remarks:** See location and general remarks above.

---

# APPENDIX C

## IMAGERY INTELLIGENCE

### SUPPORT TO INTELLIGENCE STUDIES

Intelligence preparation of the battlespace is the systematic, continuous process of analyzing the threat and environment in a specific geographic area. (Marine Corps Reference Publication 5-12C, *Marine Corps Supplement to the Department of Defense Dictionary of Military and Associated Terms*) It supports commander and staff estimates and decisionmaking. Applying the IPB process helps the commander selectively apply and maximize combat power at critical points in time and space on the battlefield. When viewed within the scope of the entirety of the IPB, imagery plays a small and focused role; however, its role is vital, especially with respect to terrain analysis and mapping tasks. In the following paragraphs, examples and formulas are provided to aid in the preparation of IPB support products and studies. They are meant as general guides for these products and not meant to replace or supersede any products being developed in accordance with local SOPs.

---

#### IMAGERY INTELLIGENCE SUPPORT TO DROP ZONE STUDIES

A drop zone (DZ) is a specific area upon which airborne troops (e.g., a radio reconnaissance team), equipment, or supplies are air-dropped. (JP 1-02, *Department of Defense Dictionary of Military and Associated Terms*) Drop zones are preplanned locations that are determined after careful consideration. When evaluating DZs, imagery analysts must consider the following factors:

- Minimum DZ dimensions (length/width computations).
- Maximum slope percentage for DZs is 30 percent.
- Surface and obstacle considerations.
- DZ accessibility and trafficability.
- Easy exit from the DZ.
- Type of aircraft employed.
- Altitude at which air delivery is to be made.
- Types of loads to be delivered.
- Availability of adequate aircraft approach and departure routes.
- Method of airdrop: free drop, high or low velocity.
- Potential approaches and exits.
- Proximity to mission objective.

- Enemy disposition.
- Alternate DZs and LZs.
- Supporting fires (in coordination with the G-3/S-3 and the fire support coordinator).

### Drop Zone Length/Width Computations

The request for DZ identification and supporting intelligence usually includes the rate of speed the aircraft will fly over the proposed area and the amount of time required to deliver a load. The imagery analyst (or all-source intelligence analyst) must be informed of the prevailing wind velocity and wind direction, both of which have an impact on the aircraft's ground speed. When the wind velocity at the delivery altitude cannot be determined, the aircraft's air speed should be used as the ground speed. The steps used to compute DZ size are discussed in the following subparagraphs.

**Computing Drop Zone Length.** The minimum required DZ length (in meters) is computed by multiplying the ground speed of the aircraft (R) (accounting for windspeed) by the time needed to release its cargo (T):  $L = R \times T$ . The ground speed is computed by multiplying the aircraft speed in knots (S) by .51, which is the conversion factor of knots to meters per second:  $R = S \times .51$ .

When computing ground speed (R), add tail wind component of wind velocity to aircraft speed (S) or subtract head wind component of wind velocity from aircraft speed (S) (see fig. C-1). Always round up the required DZ length to the nearest meter. For example, if the aircraft speed (S) is 110 kts, head wind is 20 kts, and drop time (T) is 20 seconds, the required length of the DZ (L) is:

$$L = R \times T = S \times .51 \times T$$

$$L = (110 - 20) \times .51 \times 20 = 918 \text{ m}$$

**Computing Dropzone Width.** The required DZ width depends upon the method/type of airdrop, wind drift, and formation of the aircraft—all of which is usually provided in the request. When it is not specified, the requester must be given the widths of all proposed DZs that also possess the required

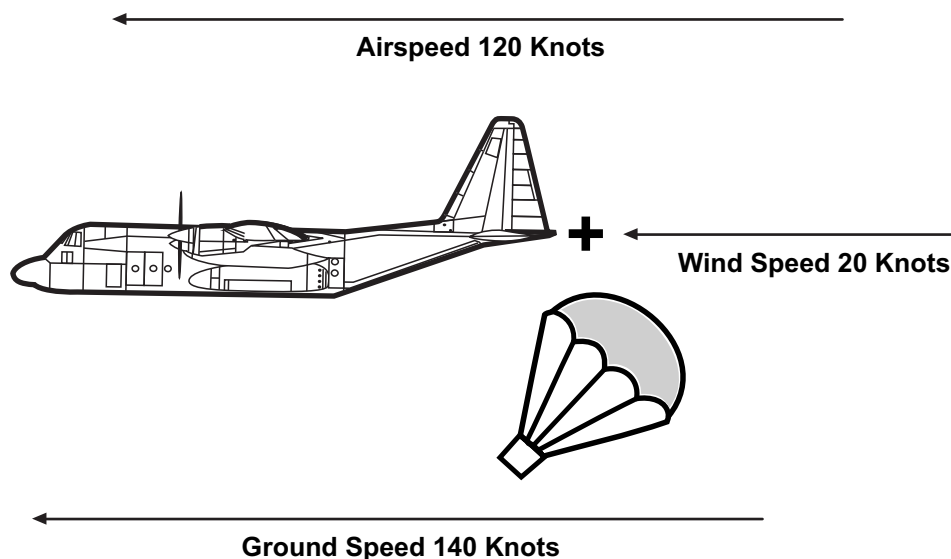

Figure C-1. Prevailing Wind Speed.



length. The wind drift formula— $D = K \times A \times V$ —is used to determine the minimum required width of a DZ. In this formula, K is a constant that represents the characteristic drift of a certain model parachute. As with the length, the required DZ width is rounded to the nearest meter.

Wind drift has the following factors:

- D = width of DZ (in meters).
- K = 4.1 (constant) for personnel parachutes; 2.6 (constant) for all other parachutes.
- V = velocity of surface wind (in knots).
- A = altitude of the aircraft (in hundreds of feet above ground level).

For example, an aircraft flying at 2,000 ft above ground level (A) is to drop a cargo load with wind speed of 11 kts (V). In this case, G13 cargo parachutes are used (2.6 constant [K]).

$$D = K \times A \times V$$

$$D = 2.6 \times (2,000 \text{ ft} \div 100) \times 11$$

$$D = 2.6 \times 20 \times 11 = 572 \text{ m}$$

**Searching for a Suitable Drop Zone.** Now that the required dimensions are known, the imagery analyst searches the imagery (or map if imagery is not available) for suitable DZs. Using a photo interpreter scale or equivalent scale, the imagery analyst measures the potential DZ length on the imagery and then computes the ground distance in meters, rounding down to the nearest meter. The following formulas are used:

- Imagery length:  $GD = PD \times DPRF$ .
- Map length:  $GD = MD \times DMRF$ .

The following legend applies to the imagery and map length formulas:

- GD = ground distance (length) (in meters).
- PD = photo distance (if in feet, then multiply by .3048, the conversion factor of feet to meters).
- DPRF = denominator of the photo representative scale factor.
- MD = map distance.
- DMRF = denominator of the map representative scale factor.
- The scale is noted as 1: DPRF or DMRF.

For example, an image has a scale of 1:25,000 (DPRF). Using a scale, the analyst measures a potential DZ to be .06 ft (PD).

$$GD = PD \times DPRF$$

$$GD = (.06 \times .3048) \times 25,000 = 457.2 \text{ m} = 457 \text{ m}$$

The imagery analyst measures the potential DZ width on the imagery (or map if imagery is not available) and then computes the ground distance in meters, rounded down to the nearest meter.

For example, an image has a scale of 1:25,000 (DPRF). Using a scale, the analyst measures a potential DZ to be .04 ft (PD).

$$GD = PD \times DPRF$$

$$GD = (.04 \times .3048) \times 25,000 = 304.8 \text{ m} = 304 \text{ m}$$

In those cases where the plot of the potential DZ is irregular in shape, the lengths and widths will be determined as shown in the sketch in figure C-2. The usable length is measured along a center line while width used is the minimum dimension of the plotted areas with ends perpendicular to the center line. In this example, the width is 140 m and the length is 380 m.

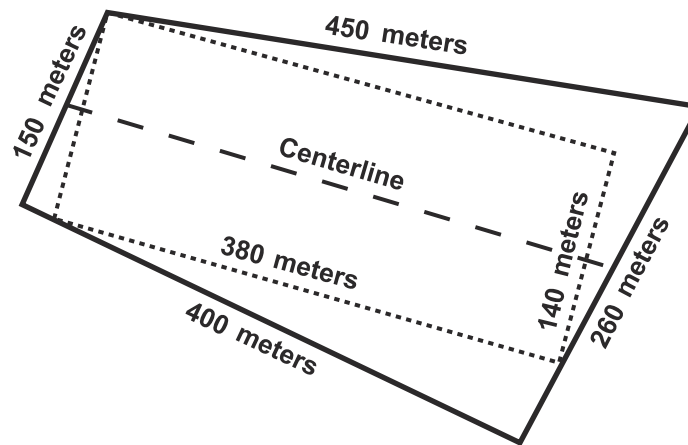

**Figure C-2. Irregular-Shaped Drop Zone.**

The imagery analyst computes flight time. For safety requirements, a DZ should be as large, or larger, than the commander's request. Normally, an area 460 m long and 180 m wide is the minimum requirement for the delivery of supplies. If a DZ of the desired length is not available, the flight time over the DZ (whatever its length) must be computed to determine how much of the load can be released in one pass and/or how many passes must be made to release the entire load. Always round the flight time down to the next lower whole second.

Flight time is computed using the following formula:  $T = L \div R = L \div (S \times .51)$ . The following legend applies:

- T = time over the DZ (in seconds).
- L = length of the DZ (in meters).
- R = aircraft ground speed (in meters per second).
- S = aircraft speed (in knots).
- .51 = conversion factor of knots to meters per second.

For example, an aircraft is flying at 105 kts (S) over a DZ measuring 150 m long (L).

$$T = L \div R = L \div (S \times .51)$$

$$T = 150 \div (105 \times .51)$$

$$T = 150 \div 53.55$$

$$T = 150 \div 53$$

$$T = 2.83 = 2$$

### Slope Calculations

After the DZ area has been determined, the imagery analyst computes the slope. A map of the area is required for this task. The slope of a DZ should not be more than 30 percent, and should be round up to the nearest percent. Both vertical distance and horizontal distance must use the same unit of measurement (feet or meters). Use 3.281 as the conversion factor from meters to feet or .3048 to convert feet to meters. Use the following formula, which will be expressed as a percentage, to compute the terrain's slope:  $SL = (VD \times 100) \div HD$ . The following legend applies to the formula:

- SL = percent of slope.
- VD = vertical distance of the DZ (altitude difference between each end of the DZ length).
- HD = horizontal distance of the DZ.
- 100 = conversion factor for percent.

For example, the length of the DZ is 900 m, one end is at an altitude of 150 ft and the other end at 200 ft, the percent of slope is 1.7%, rounded up to 2%.

$$SL = ([200-150] \times 100) \div (900 \times 3.281)$$

$$SL = (50 \times 100) \div 2,953$$

$$SL = 1.7 = 2\%$$

The contour intervals on maps are in feet or meters. The bar scales are usually in meters, yards, statute miles or nautical miles. If the bar scale is used, a conversion from one unit of measure to another may have to be performed. If a PI scale is used, the analyst must multiply the measurements by the map scale. To determine slope using a map, refer to the following steps and figures C-3 and C-4.

**Step 1.** Determine the elevation of each point. Neither point is on a contour line, so it will be necessary to interpolate. Point Y is located on an intermittent stream symbol, which may be confused with a contour line if care is not taken. The contour interval is 50 ft.

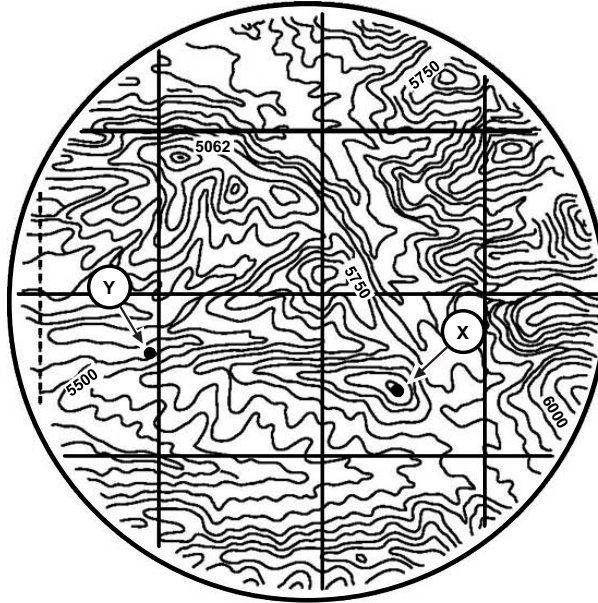

Figure C-3. Map Extraction (map not to scale).

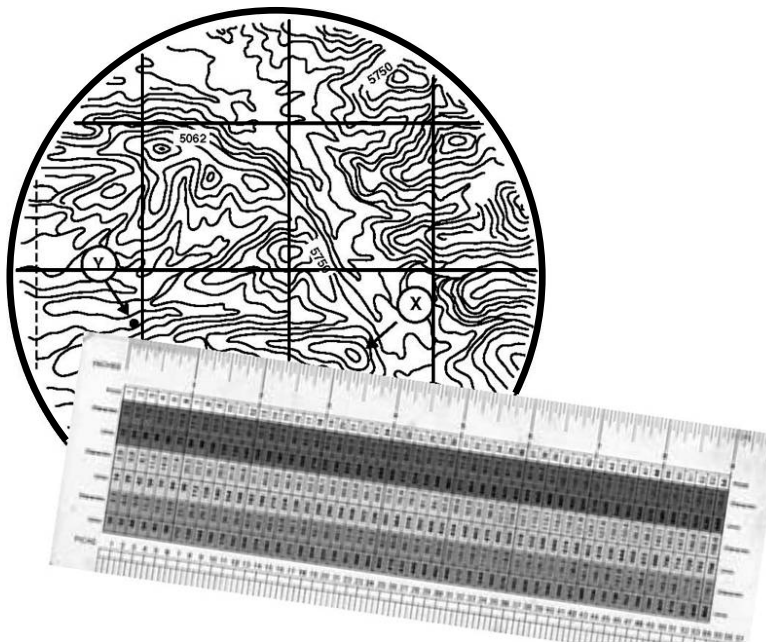

Figure C-4. Measuring from Dot to Dot (map not to scale).

**Step 2.** Measure the distance between points X and Y using a piece of paper, Pl scale, or boxwood scale. Make measurements from the center of one dot to the center of the other dot (see fig. C-4). A tube magnifier may be required to exactly align the scale with the centers of the two points to accurately determine the distance found. In figure C-4, the map distance (MD) is 2.95 cm. The ground distance is found by solving the following:  $GD = MD \times DMRF$ .

$$GD = 2.95 \text{ cm} \times 50,000 = 147,500 \text{ cm} = 1,475 \text{ m}$$

When comparing elevations and horizontal distance, elevation is measured in feet and distance is measured in meters, so a conversion from one to the other is required.

$$GD = 1,475 \text{ m} \times 3.281 \text{ ft/m} = 4,839.475 \text{ (rounded up to 4,840 ft)}$$

**Step 3.** Use the slope formula:  $VD = \text{change in elevation from point V to point Y}$ :

$$SL = (VD \div HD) \times 100 = (XY \div HD) \times 100$$

For example, a DZ with a length of 4,840 ft (HD) has elevations of 5,925 ft and 5,475 ft.

$$SL = ([5,925 \text{ ft} - 5,475 \text{ ft}] \div 4,840 \text{ ft}) \times 100$$

$$SL = (450 \text{ ft} \div 4,840 \text{ ft}) \times 100 = 9.2975; \text{ rounded up to } 10\%$$

$$SL = 10\%$$

### Surface and Obstacle Considerations

When both size and slope of a proposed DZ are acceptable, inspect imagery of the area for the presence of obstacles and potentially hazardous surface conditions. This requires the examination of photography in stereoscopic pairs as well as a review of available maps. Two major reasons for the examination of imagery are to protect troops from injury during a drop and to prevent the unsuccessful drop of equipment. The most acceptable DZ is a flat, resilient surface without obstructions.

Unfavorable or hazardous surface conditions are normally provided by the terrain detachment, including information on—

- Water.
- Marshland.
- Gullies.
- Drop-offs (cliffs).
- Dense trees.
- Dense low vegetation.
- Large rocks.
- Obstacles that are manmade features, such as—
  - Power lines and poles.
  - Buildings.
  - Towers.
  - Fences.
  - Military impediments (e.g., stakes, barriers, barbed wire).

### **Drop Zone Accessibility and Trafficability**

A favorable DZ must have easy accessibility for both approach and exit. If possible, DZs near LOCs should be selected. Certain questions must be answered before DZ identification can occur and the tactical situation will add other questions, such as the following:

- Will the approach involve more troops and equipment or fewer troops and less equipment than the exit?
- Will the exit involve more troops and equipment or fewer troops and less equipment than the approach?
- Will the approach or exit occur during daylight or night?

When troops are parachuted into a DZ, it is important that they have an easy exit. The exit should be in the general direction supporting the ground tactical plan. When supplies or equipment comprise the load, personnel on the ground must be able to approach the area, recover the material, and exit with the material. When evaluating a potential DZ for accessibility, the type of load will be a major consideration. For example, if wheeled vehicles are parachuted into a DZ, troops on the ground may be able to approach the DZ through a densely wooded area or up a steep slope; however, the vehicles may not be able to exit through the forest or negotiate the slope.

A factor related to accessibility is the trafficability of the soil. Swampy soil or in some cases fine sand may rule out the selection of a DZ. The parachuted equipment may bog down or troops may not be able to approach or exit the area rapidly. Therefore, in order to afford easy cross-country movement of vehicles and personnel in and out of the DZ, trafficability of access routes must be considered.

### **Drop Zone Reports and Overlays**

Normally, the imagery analyst assists all-source intelligence and GEOINT analysts with preparing a report in accordance with local SOPs. A primary DZ and alternate DZs that meet the specified intelligence requirements will be selected. This information is provided to the P&A cell OIC, who in turn recommends these to the ISC and G-2. Upon request, an overlay of the primary and alternate DZs will be prepared. Geospatial intelligence analysts generally will prepare this overlay.

---

## **IMAGERY INTELLIGENCE SUPPORT TO HELICOPTER LANDING ZONES STUDIES**

An LZ may contain one or more landing sites. An HLZ is a ground area specified for landing assault helicopters to embark or disembark troops/cargo. Primary and alternate HLZs that meet the intelligence requirements will be identified, analyzed, and provided to the supported ground unit and aviation commanders. The ground unit commander (or helicopter unit commander) in coordination with the supporting air mission commander (AMC) will select the final location of the HLZ to best support the ground tactical plan.

### General Helicopter Landing Zone Criteria

The same criteria used for determining a DZ apply when selecting an HLZ from maps, aerial photographs, and physical ground or aerial reconnaissance. However, additional information, normally supplied by the ACE commander or AMC, should also be used when selecting an HLZ. This should include the HLZ type and the number and type of helicopters used. An HLZ is a helicopter landing area that encompasses one or more helicopter landing sites, making a helicopter landing site a subdivision of an HLZ. The size of a landing site depends on the number of LPs and the size of the LPs. An LP is a designated touchdown point where a single helicopter may land.

The size of the landing site will depend on the number and size of LPs within it. As a guide, a helicopter requires a relatively level, cleared, circular area of 20 to 75 m in diameter. However, this may vary depending on the type of helicopter and because helicopters require more usable landing area at night than during the day. The criteria provided in figures C-5 and C-6 and C-7, on page C-10, represent guidance on LP preparation. Helicopter units will designate the size (small, medium, or large) to be used by their units for specific operations. Numerous considerations, such as helicopter type, unit proficiency, nature of loads, and weather conditions, may apply to the size of LPs used. General distances between LPs within a landing site in daytime landing are as follows (measured center to center):

- Small LPs: 80 ft (25 m).
- Medium LPs: 115 ft (35 m).
- Large LPs: 165 ft (50 m).

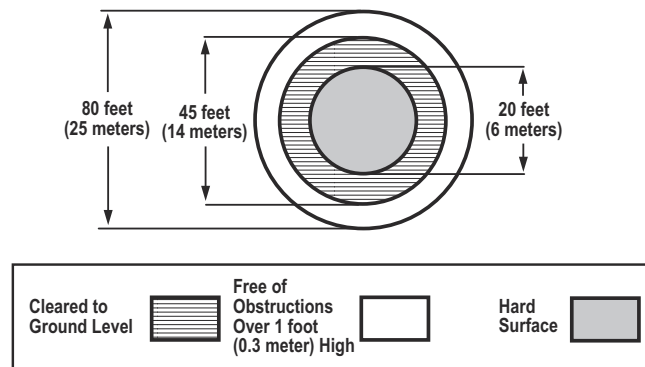

Figure C-5. Small Landing Point Dimensions.

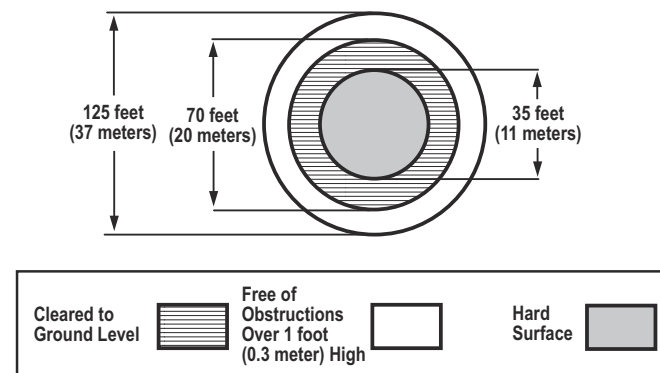
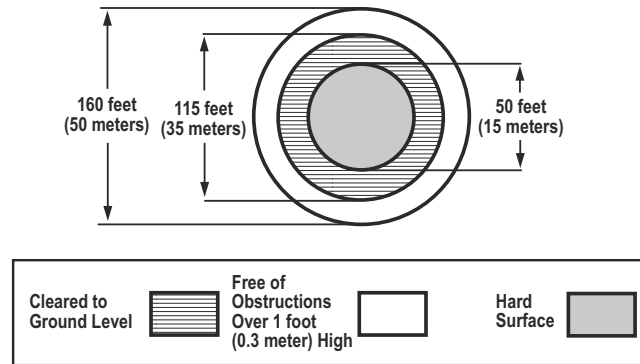

Figure C-6. Medium Landing Point Dimensions.



**Figure C-7. Large Landing Point Dimensions.**

Most helicopters cannot land or take off vertically when they are fully loaded; therefore, when they are, a larger area or a better approach is needed. The ACE commander has the final authority in establishing the landing area criteria for assigned helicopters in daytime and nighttime missions. This may change from time to time, depending on how heavily loaded the aircraft will be, the place and time of landing, and the anticipated weather conditions. During specific missions, the AMC may exercise this authority. For example, the area requirement may be larger when—

- A helicopter is heavily loaded.
- Helicopter cargo is sling loaded.
- A landing must be made at night or during other periods of reduced visibility.
- There are terrain obstructions or obstacles in the area.
- An area is located at high elevation.
- The temperature is hot or when humidity is high.

The ACE commander or AMC should provide the G-2 or ISC with the required dimensions for all HLZs, based on various flight and landing formations. This action will assist imagery analysts and all-source intelligence analysts with locating potential HLZs.

### Helicopter Landing Zone Computations

When determining the size of the HLZ area, proceed in the same manner as for calculating the DZ area: first computing the required and then the potential HLZ areas. To determine the HLZ area, use the procedures explained in the following subparagraphs.

**Step 1.** Determine HLZ dimensions on photographs or maps. If the results are in fractions, round down to the nearest foot or meter. Use the same basis for all measurements (either feet or meters).

Potential HLZ length when measuring:

Imagery:  $GD = PD \times DPRF$

On a map:  $GD = MD \times DMRF$

Potential HLZ width when measuring:

Imagery:  $GD = PD \times DPRF$

On a map:  $GD = MD \times DMRF$

**Step 2.** Determine how many helicopters will be able to land in the potential HLZ area in a two-trail formation during daytime. Round up converted LP dimensions.



**Step 3.** Determine the number of LPs (or helicopters) from front to rear of the potential HLZ. Round down number of helicopters.

LPs from front to rear = potential HLZ length

Minimum recommended LP length

**Step 4.** Determine number of lateral LPs of the potential HLZ.

Number of lateral LPs = potential HLZ width

Minimum recommended LP width

**Step 5.** Determine the total number of helicopter LPs of the potential HLZ.

Total number of helicopter LPs = number of LPs from front to rear x number of lateral LPs

### Slope Computations

The slope for an HLZ should not exceed 8 percent if the helicopter is to land. When the slope is more than 8 percent, provide the requester with the exact percent figure so he can assess alternatives and decide. Slope is important because when the ground slope is less than 8 percent, helicopters should land upslope. When the slope is more than 8 percent, helicopters should land side-slope (see fig. C-8 on page C-11). At the pilot's discretion, it may be possible for a helicopter to hover just in contact with the ground on slopes greater than 8 percent.

When the slope is greater than the allowable 8 percent, report this to the requester. The site may still be usable if the commander chooses to hover the aircraft and load/unload troops and supplies by rope or ladder.

When computing the slope, do not depend entirely on the map. Study imagery of the area as well. The map contour intervals may indicate that the percent of slope is sufficient, but sloping or rugged terrain can be seen only with a stereoscope.

To compute the slope of each potential HLZ, use the same formula that was used to find the slope for DZs:  $SL = (VD \div HD) \times 100$ .

When computing the HLZ slope, consider the following:

- *Direction of positive slope.* The direction of positive slope is important for the approach and exit direction.
- *Number of aircraft used.* The AMC will provide the number of aircraft used.
- *The density altitude.* The altitude, temperature, and humidity determine the density altitude. For planning purposes, as density altitude increases, the landing area should increase proportionately.

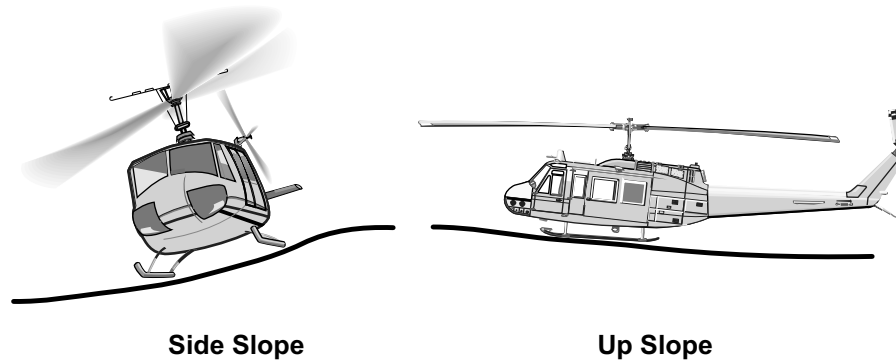

**Figure C-8. Helicopter Landing on Side Slope and Up Slope.**

- Approach/departure directions. When possible, the direction of approach and departure should be into the wind. However, if there is only one suitable approach direction due to obstacles or the tactical situation or in order to make maximum use of the available HLZ, most helicopters can land with a crosswind (10 kts or less) or a tailwind (5 kts or less). The same applies to departures from the HLZ.
- Loads. When fully loaded, most helicopters cannot ascend or descend vertically.

---

## AIRCRAFT LANDING ZONE

An aircraft LZ (also referred to as runway or landing strip) is a specified location used for landing aircraft. Potential aircraft LZs are selected to meet the intelligence requirements of the supported ground and aviation units' commanders. Potential aircraft LZ locations will be identified and analyzed based on aerial imagery, current maps, and other available intelligence.

### Aircraft Landing Zone Criteria

Aircraft LZs are established so aircraft can safely land and take off. They also provide guidance for aircraft while they taxi and park. They have one or more landing strips. The landing strip consists of a runway and may include taxiways, parking points, and dispersal areas. Selection of a potential aircraft LZ depends on the type of aircraft, runway dimension requirements (see Table C-1 on page C-13), surface, and location.

Unmanned aircraft systems sometimes require landing strips. The requirements for these vary. In order to ensure these requirements are met, close coordination with the aviation units that plan to use the landing zone is required for any aircraft landing zone products.

**Table C-1. Runway Dimension Requirements.**

	<b>Airfield Type</b>	<b>Runway Length (in feet)</b>	<b>Runway Width (in feet)</b>	<b>Runway Shoulder (in feet)</b>
<b>Forward Area</b>	Attack & Utility	N/A	N/A	N/A
	Vertical Lift	N/A	N/A	N/A
	Light Lift	1,200	60	10
	Medium Lift	2,500	80	10
<b>Support Area</b>	Attack & Utility	N/A	N/A	N/A
	Vertical Lift	N/A	N/A	N/A
	Light Lift	1,500	60	10
	Medium Lift	3,500	60	10
	Heavy Lift	6,000	100	10
	Tactical	5,000	60	4
<b>Rear Area</b>	Medium Lift	6,000	72	10
	Heavy Lift	10,000	156	10
	Tactical	8,000	108	20

### **Airfield Type**

There are two types of aircraft LZs, classified according to their size and degree of improvement: a hasty landing strip and a deliberate landing strip. A hasty landing strip has an unimproved surface, which normally is acceptable for marginal weather, but is unusable during prolonged poor weather. After a period of occupation, most landing strips (terrain permitting) can be improved to meet the requirements of a hasty landing strip. A hasty landing strip has the following characteristics:

- Minimum length: 3,000 ft, plus a 10 percent overrun at each end.
- Minimum width: 50 ft, plus a 10-ft shoulder on each side.
- Minimum lateral clearance: 100 ft on each side of runway centerline.
- Has taxiways, parking areas, and may include dispersal areas.

A deliberate landing strip, at minimum, should have all the characteristics of a hasty landing strip plus any other facilities needed to meet the standards required by any aircraft. It has an all-weather capability and is usually a permanent installation with a control tower, hard surface runways, taxiways, and parking ramps.

### **Aircraft Landing Zone Computations**

To determine the length and width of the area, use the same formula that was used to measure a DZ or an HLZ, and then identify the potential aircraft LZ by type. For example, if the photo scale is 1:20,000, the photo distance (length) is .08 ft and the photo distance (width) is .004 ft, then the potential aircraft LZ could be either a hasty or deliberate type depending on construction and facilities.

### Slope Computations

When computing the slope, the maximum slope for a potential aircraft LZ should not exceed 10 percent. Always round slope up to the nearest percent. Use the same formula that was used to compute the SL of a DZ or HLZ:

$$\text{SL (expressed as a percentage)} = \frac{\text{VD}}{\text{HD}} \times 100$$

### Surface and Obstacle Considerations

The surface of a potential aircraft LZ must be firm and smooth enough to allow heavily loaded aircraft to land, taxi, park, and take off without delay or damage to the aircraft. It should be located away from obstacles, such as mountains, telephone wires, tall buildings, and trees. The area should be free of heavy rocks and stumps so troops can clear it easily. This is particularly important for hasty strips, which may have to be established quickly. The area should be dry, as water or marshland can cause early erosion.

### Landing Zone Accessibility

An aircraft LZ should have convenient access, such as roadways or other level terrain, to and from the area. If there are prevailing winds, the runway should be oriented, if possible, so that aircraft can land and take off into the wind. The minimum size of an aircraft LZ depends on the type of loads, the direction and velocity of winds, and the condition of the ground. Consider the following factors when establishing an aircraft LZ:

- Soft, wet, slippery, or any other unfavorable surface conditions will increase the need for a longer aircraft LZ.
- Crosswinds may require an increase in width of the aircraft LZ.
- Uphill take off and downhill landings will require longer runways. The maximum slope on any aircraft LZ should not exceed 10 percent.
- Obstacle clearance is measured from the obstacle to the approach and departure end (if there are obstacles at the approach and departure ends of the aircraft LZ). Be sure to obtain a 10:1 clearance ratio (same as used for an HLZ).

### Aircraft Landing Zones Overlays

Per the intelligence production requirement, all-source intelligence analysts, assisted by imagery analysts and GEOINT analysts, will prepare an overlay of the potential primary aircraft LZ and an alternate aircraft LZ, if deemed necessary. A relief and drainage overlay may also be provided. Aircraft LZs are normally referred to by their nickname or a color. Situation and time permitting, GEOINT analysts will prepare this overlay.

---

## IMAGERY INTELLIGENCE SUPPORT TO BEACHES STUDIES

Imagery intelligence support is crucial for amphibious operations. Imagery intelligence helps to provide commanders with the information they need to decide which beaches to use and how those beaches can be used for amphibious operations. They do this through detailed analysis of the beaches and surrounding areas.

### **Beach Definitions**

A beach is the area extending from the shoreline inland to a marked change in physiographic form or material, or to the line of permanent vegetation. In amphibious operations, a beach is that portion of the shoreline designated for landing of a tactical organization. A landing beach is that portion of a shoreline usually required for the landing of a battalion landing team. However, it may also be that portion of a shoreline constituting a tactical locality (such as the shore of a bay) over which a force larger or smaller than a battalion landing team may be landed. A beach landing site (BLS) is a geographic location selected for across-the-beach infiltration, exfiltration, or resupply operations. A beachhead is a designated area on a hostile or potentially hostile shore that, when seized and held, ensures the continuous landing of troops and materiel and provides maneuver space requisite for subsequent projected operations ashore. Finally, a landing area is the part of the operational area within which are conducted the landing operations of an amphibious force. It includes the beach, the approaches to the beach, the transport areas, the fire support areas, the airspace above it, and the land included in the advance inland to the initial objective.

### **Beach Landing Site Factors**

A BLS is a continuous segment of coastline over which troops, equipment, and supplies can be landed by surface means. Primary and alternate BLSs are selected and prioritized after considering the commander's intent and guidance, CONOPS and scheme of maneuver, enemy disposition, size of the area required, terrain features, weather factors, supporting fire, and proximity of the objectives.

Amphibious operations require a detailed study of hydrography, weather, climate, and terrain. The terrain portion is primarily the responsibility of MAGTF GEOINT analysts. A tactical study of the terrain is prepared by all-source intelligence analysts with major assistance from imagery analysts and GEOINT analysts. (See MCWP 2-3 and MCWP 2-26, *Geographic Intelligence*, for additional information on tactical studies of the terrain.)

The landing force commander selects specific landing beaches from available beach landing sites. When the amphibious task force is composed of two or more attack groups with related landing groups, a landing area may be selected for each attack group. In this case, each landing group commander selects the landing beaches from within the assigned area. The principal factors in the selection of landing beaches are—

- Suitability for beaching landing ships, landing craft, and amphibious vehicles.
- Beach trafficability.
- Suitability of offshore approaches.
- Number, location, and suitability of beach support areas and beach exits.
- Location, type, and density of beach obstacles, including underwater obstacles.
- Nature of the terrain immediately inland from the beaches.
- Suitability of LOCs—including roads, railroads, and waterways.
- Suitability of the beach from the standpoint of expected weather and tidal conditions.
- Known hostile force dispositions, strengths, and capabilities.

Beaches are categorized by their shape (see fig. C-9):

- Concave (point A to point B).
- Convex (point B to point C).
- Straight (point C to point D).
- Irregular (point A to point D).

### Beach Types

Beach types include the following:

- Coastal plain.
- Coastal ridge.
- Cliff or terrace.
- Coral reef.
- Glacial.
- River mouth or delta.
- Pocket.

**Coastal Plain.** A landing on a wide coastal plain beach provides unrestricted maneuver room, so a subsequent advance from the beach can be made in any direction. Boundaries and objectives are more difficult to locate on this type of terrain; there are few prominent registration points for artillery, naval gunfire, and aerial bombardment. Usually there is no natural defensive terrain on the flanks of the beachhead, so more troops are required to protect the flanks. Some coastal plain beaches are near marshy and swampy terrain, which may hinder movement from the beach.

**Coastal Ridge.** A coastal ridge beach has terrain that rises evenly to a considerable distance back from the beach that gives the defender excellent observation and fields of fire. More commonly, the coastal area remains flat for some distance and then rises in a steep gradient to a coastal ridge.

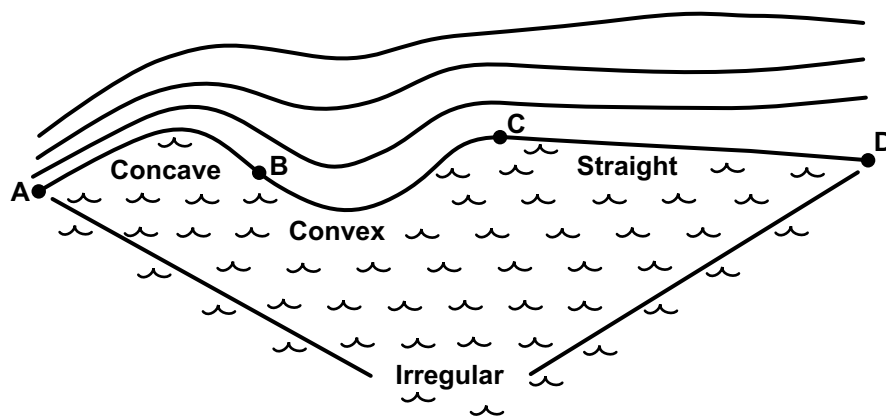

Figure C-9. Beach Categories.

**Cliff or Terrace.** A cliff or terrace beach is usually quite narrow. The delineation of a cliff beach from a terrace beach basically is established by the height of the landmass immediately behind the beach. Cliff beaches may have rocks and debris that accumulate by erosion of the adjoining severe terrain. The surface is made up of the same type of material as the major adjacent landform. If wave action is strong on a cliff beach, any fine material is washed away resulting in a beach covered with boulders or barren rock. Cliff beaches isolated from strong wave action are usually composed of sand and are similar in surface materials to coastal plain beaches. A terrace beach may be composed of loose sand or rocks; it may be barren rock or strewn with boulders.

**Coral Reef.** A coral reef beach is located in the coral region (normally between 30 degrees north latitude and 30 degrees south latitude) protected by a barrier reef with fringing reef along the shoreline, or it is located on an atoll. Any beach protected by a barrier reef is composed primarily of fine coral sand (coral skeletal remains, broken shells, and hardened algae) and is usually firm and narrow. When the beach or fringing reef is exposed to wave action, the foreshore is eroded. The coral reefs themselves normally present significant obstacles with abrupt seaward slope and the exposed offshore edge of the reef is steep. The upper surface of the reef may be extremely rough with jagged coral formations rising above the surface and deep pits indenting the surface of the reef. An atoll is a ring-shaped coral island or group of coral islands enclosing a lagoon or another island. It has the same basic characteristics as the coral barrier reef.

**Glacial.** Glacial beaches are usually found in the higher latitudes, normally above 60 degrees north and 60 degrees south latitude. These beaches were eroded by glacial action and have round and irregular shorelines with numerous inlets; some may be quite deep, long, and narrow, with almost perpendicular, smooth mountain walls rising to great heights. This type of coast is very dangerous to navigation because of the islands and rocks off entrances to the inlets. The beach may be composed of material that has no geologic relationship to the coastline with depositions of material carried from the hinterland by the glaciers. This is often a mixture of silt, sand, gravel, and rocks.

**River Mouth or Delta.** This type beach is easy to identify due to its proximity to the mouth of a major stream or river. It undergoes a greater physical change than the other beach types, and the foreshore is composed primarily of the type of sediment carried by the stream or river.

**Pocket.** A pocket beach is found on many of the coasts throughout the world and has a wide range of composition and topography. The irregular coastlines, where pocket beaches are quite common, are made up of headlands and indentations with the pocket beaches found in the indentations. This type of beach is divided into two general areas: the end zones and central zone.

The end zones are those areas on the flanks inside the beach termination points. They are protected from direct wave action by the headlands and subsequently the beach soil is usually fine sand.

The central zone is that portion of the entire beach between the end zones. It exhibits the same characteristics and soil conditions of any beach exposed to wave action. Any highlands behind the beach may provide the source material continually washed down and deposited on the beach. Lowlands behind the beach, however, will have little effect on its character.

A common problem affecting some pocket beaches is that many of the bays or other indentations fronting the beach may become blocked by sandbars built up by sand drifting along the coast in long shore currents. These sandbars may become attached to the mainland at the upstream end, and any open channel that might exist will occur at the downstream end. Sometimes these sandbars connect offshore islands to the mainland. Pocket beaches are usually concave shaped.

### Beach Landing Site Criteria

The required beach area for amphibious operations is calculated based on the original requester's guidance, the type of forces conducting the ship-to-shore maneuver, local SOPs, and METT-T. To identify whether an area is suitable for beach landings, intelligence analysts will require the following information:

- Minimum length of beachfront necessary.
- Types of equipment being landed.
- Types of transports to be used, including length and width of each transport type.
- Transport capability. (Can it land on the beach? What is the required minimum depth [draft]?)

### Beach Landing Site Computations

As with the calculation of measurements of DZs, HLZs, and aircraft LZs, beach landing length is computed using the formula  $GD = PD \times DPRF$ . Measurements are taken from one termination point to another (see fig. C-10) and rounded down to the nearest meter.

The beach termination points are the extreme ends of the selected beach. The total length of the beach is measured between these points following the natural coastline.

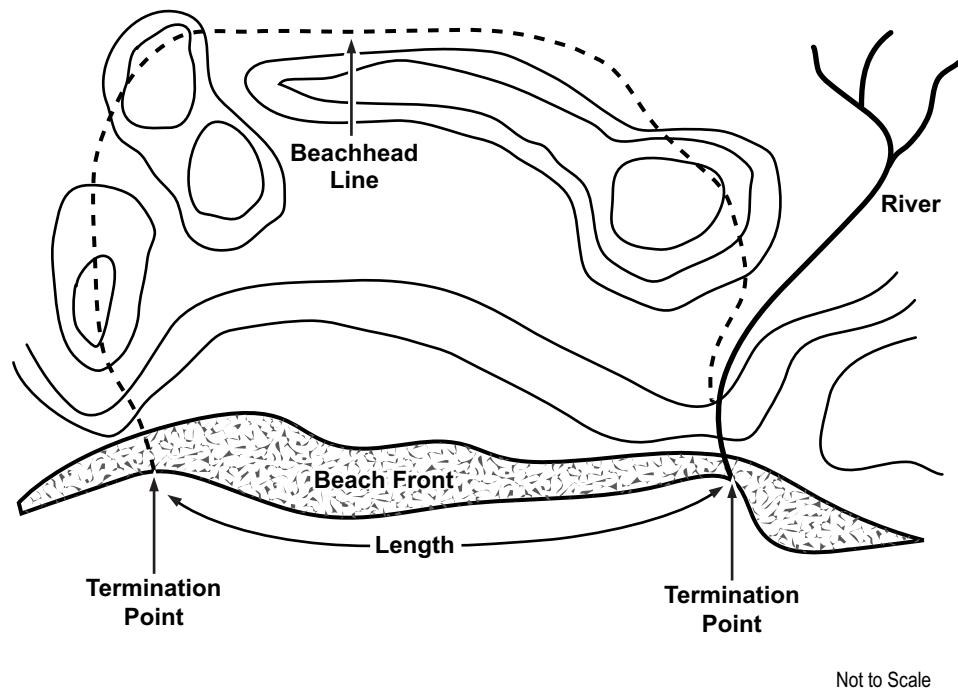

Figure C-10. Landing Beach Length.



The beach width is calculated using the horizontal dimensions of the beach measured at right angles to the shoreline from the line of extreme low water inland to the landward limit of the beach (the coastline). It usually will not be uniform and, therefore, is determined at various points along the beach.

The beachhead line is roughly semicircular and encompasses the area near the coast large enough for the deployment of the assault force and its supplies and equipment, and usually includes terrain features that are the initial objectives of the assault force. The beachhead line, if established, must be held so the subsequent landing forces can land and deploy in proper battle order. Loss of the beachhead—or major enemy force penetration into it—places the entire amphibious operation in jeopardy.

The beachfront extends from low tide limit to the high tide limit and usually coincides with the foreshore (see fig. C-11).

### Percent of Slope and Gradient Computations

Measurements of the width of the beachfront are taken to calculate a beach landing length. Apply the same formula that was used to determine the percent of slope of a DZ, HLZ, or aircraft LZ:

$$SL = (VD \div HD) \times 100$$

The VD is the height difference of the beachfront, which is from the edge of the beachfront (low tide limit) to the high tide limit. The HD is the horizontal (ground) distance of the beachfront. Always round up the percent of slope to the nearest percent.

Combined offshore or foreshore/back shore beach gradient is expressed as a ratio of the rise in elevation of one unit of measure to the horizontal (ground) distance in a number of the same unit of measure (e.g., 1:15).

$$\text{Gradient} = VD \div HD$$

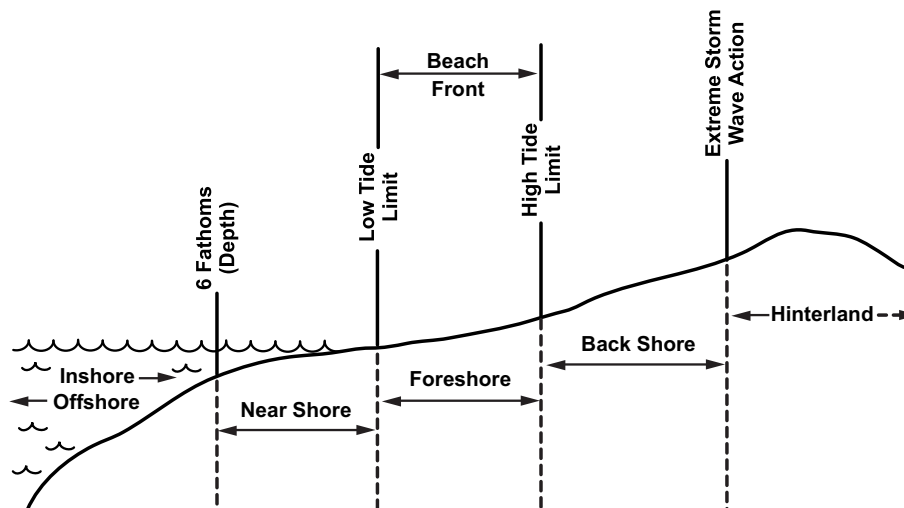

Figure C-11. Shores.

A quick way to obtain the gradient (1:) is to invert the fraction and divide the denominator by the numerator. Round up fractions to the next whole number (e.g., 1:50.52 = 1:51). For example, if VD equals 150 m and HD equals 3,000 m, then the gradient is—

$$\text{Gradient} = 1: (3,000 \div 150) = 1:20$$

When computing the combined foreshore/back shore gradient, measure from the shoreline to the nearest 20-m contour line used for the start of the hinterland. Be sure to transfer the 20-m contour line from the map to the photograph by interpolation prior to making the measurement. The gradient is further expressed as shown in table C-2.

**Table C-2. Beach Gradients.**

Less than 1:120	Flat
1:120 to 1:60	Mild
1:59 to 1:30	Gentle
1:29 to 1:15	Moderate
1:14 or more	Steep

The depth lines or curves illustrated at 1, 2, and 3 fathoms (1 fathom = 6 ft) (see fig. C-12) are established to determine the offshore gradient and to assist in the safe approach of the landing craft. The depth curves may be a series of dots (as shown) or solid lines.

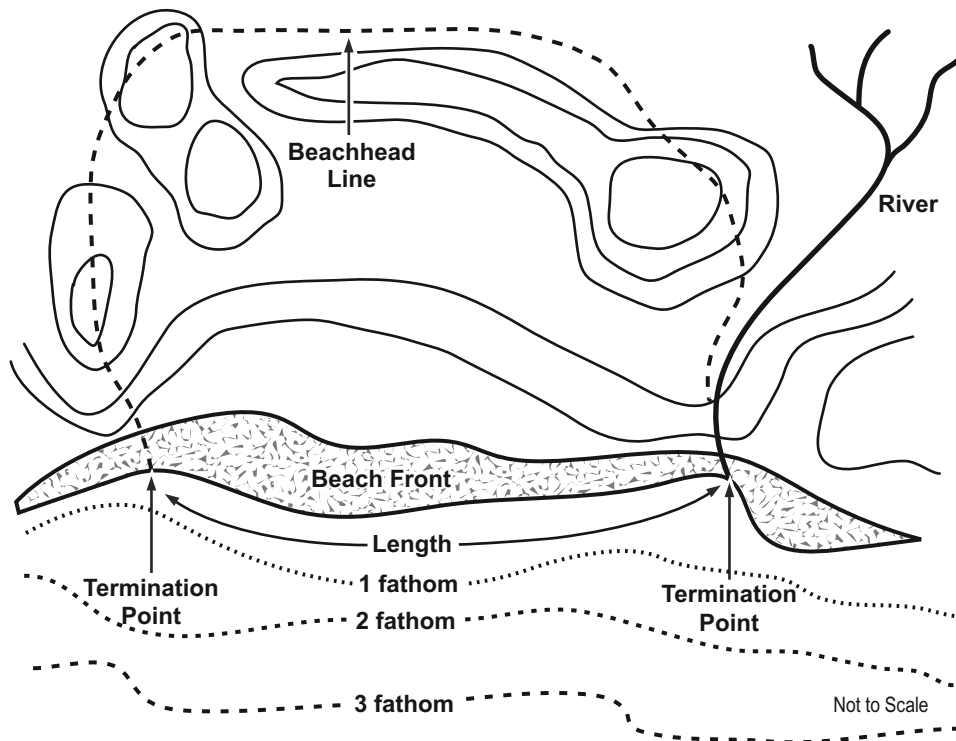

**Figure C-12. Typical Beach Landing Area.**

### Surface and Obstacle Considerations

Normally, the surface condition of the combined foreshore and back shore areas is considered critical upon landing. The foreshore is generally white; the back shore begins where the beach discoloration changes from white to brownish gray and ends at the beginning of the hinterland by revealing a darker tone and taller vegetation on aerial photography. Unfavorable or hazardous surface conditions include the following:

- Large rocks or reefs.
- Drop-offs (cliffs).
- Dense trees.
- Dense vegetation.

Obstacles include the following:

- Buildings.
- Military impediments (e.g., landing craft barriers, barbed wire).

### Beach Landing Site Accessibility

Because of the configuration of shorelines, usually the area most suitable for the execution of a landing operation is also the most easily organized for defense. The ideal beach for amphibious landing is one with—

- No obstructions in the sea approaches.
- Deep-water close inshore.
- Near shore gradients that are sufficiently deep for dry ramp beaching of landing craft and ships.
- Soil composed of firm sand with gentle gradients or slopes.
- Small tides.
- No currents.
- No surfs.

The beach terrain should be—

- Gently rising, relatively clear, and have a firm surface that has adequate drainage.
- Flat or gently rising terrain, backed by a coastal range high enough to mask the landing area.

Ideal conditions are rarely found, so suitable areas must be evaluated to determine those that come nearest to optimum requirements. Other terrain considerations include dunes, mountains, and sandbars.

**Dunes.** Ground that is sharply broken by extensive dunes or a low coastal plateau provides the attacker with concealment from the defender's observation. However, small compartments and corridors limit the range of defensive fire. Dunes are classified as transverse, longitudinal, and coastal.

Transverse dunes are mounds of sand with their longest dimensions oriented at right angles to the prevailing wind. They usually have a steeper slope on the leeward side than they have on the windward side.

Longitudinal dunes are sand formations with their longest dimensions oriented in the same direction as the prevailing wind. They may have a symmetrical shape or may be without any particular shape at all and may be over 100 miles long. They are usually not backed by areas of standing water, such as swamps or marshes.

Coastal dunes, because they are formed by windblown sand, are quite unstable landforms. They may appear in one location as a transverse dune, only to disappear and reform as a longitudinal dune elsewhere. The winds responsible for their formation may also be the means of their destruction.

**Mountains.** Mountains located directly on the sea usually limit the number of beaches large enough to accommodate a landing force of effective size. Where steep ground is lightly defended or neglected by the defender, a small force may seize it and gain surprise. Airborne or airmobile troops may be used to block the movement of defensive reserves to the landing area or to secure passes through the mountains. Such action prevents the defender from interfering with the amphibious landing.

**Sandbars.** These offshore sand formations are usually found near coastlines with gentle beach gradients. During stormy weather the sandbars will be found further offshore than during calmer weather conditions. Sandbars paralleling the coast may cause a lagoon to form between themselves and the coastline; direct access to the shore is dependent on openings (channels) through the sandbar areas. The locations of these channels are highly variable, and current photography is required before the actual landing takes place. Soil analysis, beach materials, and other trafficability aspects are normally reported by terrain and soil analysts; however, imagery analysts will determine beach exits, such as roads or airstrips.

### **Beach Landing Site Collection Checklist Preparation**

A collection checklist must be prepared for each potential BLS using the following items:

- Identification: local name and military designation.
- Location:
  - Map reference, including the series and sheet number(s) of both tactical and air/ground series.
  - Political unit, area, universal transverse mercator (UTM) coordinates, and geographic coordinates of the termination points.
  - Landmark reference, a description and location of the landmark and azimuth and distance from landmark to termination point.
- Related water body or watercourses (cross-reference to appropriate collection file).
- Length between termination points.
- Seashore form (concave, convex, straight, or irregular).

- Coastal terrain type, such as emergent, submergent, compound, coral reef, delta, volcanic, fault, or manmade.
- Alignment (high-water shoreline and low-water shoreline).
- Beach width at low water.
- Beach width at high water.
- Backshore:
  - Slope.
  - Material (composition, texture, trafficability).
  - Obstacles.
  - Vegetation.
- Foreshore:
  - Slope.
  - Material (composition, texture, and trafficability).
  - Obstacles.
  - Vegetation.
- Near shore (give alignment and distance from low water shoreline):
  - 10 m (5 fathoms) depth line at low water.
  - 6 m (3 fathoms) depth line at low water.
  - 4 m (2 fathoms) depth line at low water.
  - 2 m (1 fathom) depth line at low water.
  - Obstacles.
- Reefs (near shore):
  - Type and location.
  - Distance from low water shoreline.
  - Length and width.
  - Slope (direction).
  - Depth to surface of reef at low tide.
  - Depth to surface of reef at high tide.
  - Height of surface above water at high and low tide.
  - Effects of surf.
  - Effects on tide.
  - Channel through reef (alignment, width, and depth at low water).
- Reefs (offshore):
  - Type and location.
  - Distance from low water shoreline.
  - Length and width.
  - Slope (direction).
  - Depth to surface of reef at low tide.
  - Depth to surface of reef at high tide.

- Height of surface above water at high and low tide.
- Effects of surf.
- Effects on tide.
- Channel through reef (alignment, width, and depth at low water).
- Offshore conditions:
  - Water depth.
  - Offshore islands (location and characteristics).
  - Sandbars:
    - \* Location and distance from low water shoreline.
    - \* Length and width.
    - \* Consistency.
    - \* Slope (seaward and landward).
    - \* Passages (alignment, width, and depth).
    - \* Depth at high and low waters.
    - \* Obstacles (type, location, and characteristics).
- Beach features (natural and manmade, such as cusps, runners, stream mouths, groins, piers, or outfall pipes):
  - Type and location.
  - Number and extent.
  - Bypass possibilities.
  - Influence on operations.
- Tide:
  - Type (diurnal, semi-diurnal, or mixed).
  - Type range (spring, topic, and diurnal).
  - Range.
  - Meteorological effects.
- Surf:
  - Breakers (type, average height, distance formed from shorelines).
  - Period.
  - Width of surf zone.
  - Direction from which swells approach coast.
  - Weather and seasonal effects.
- Currents:
  - Location.
  - Direction.
  - Velocity.
- Beach exits:
  - Type and location.
  - Number and condition.
- Coastal terrain (cross-reference to appropriate collection file):

- Critical terrain features (location, type, bypasses, and influence on operations).
- Obstacles (location, type, extent, bypasses, and influence on operations).
- Cross-country movement (troops, wheeled vehicles, and tracked vehicles).
- Support area concealment and cover (location and type).
- Dispersal and storage area (location and description).
- Availability of fresh water (location and quantity).
- Defenses (location and type).

Terrain overlays are normally prepared by the terrain analysis detachment and added to the checklist. Overlays include presentations depicting cross-country movement, vegetation, slope, soil drainage pattern, and ridgelines.

### **Beach Landing Site Overlays**

Imagery analysts assist all-source intelligence and GEOINT analysts with preparing overlays of the proposed primary and alternate beach landing sites. Beach landing sites are referred to by their nicknames. See MCWP 2-26 for information on the preparation of overlays.

---

# APPENDIX D

## NATIONAL IMAGERY

### INTERPRETABILITY RATING SCALE

---

#### BACKGROUND

Imagery analysts use the NIIRS to define and measure the quality of images and performance of imaging systems. Through a process called rating an image, imagery analysts use the NIIRS to assign a number indicating the interpretability of a given image. The NIIRS concept provides a means to directly relate the quality of an image to the interpretation tasks for its use. Although the NIIRS has been applied primarily in the evaluation of aerial imagery, it also provides a systematic approach to measuring the quality of photographic or digital imagery, the performance of image capture devices, and the effects of image processing algorithms.

The NIIRS is a task-based scale consisting of nine graduated levels. At each level, representative exploitation tasks (termed criteria) indicate the level of information extracted with an image of a given interpretability level. For example, in an NIIRS 2 image, imagery analysts should be able to detect large hangars at an airfield; whereas, in an NIIRS 8 image, they should be able to identify the rivet lines on bomber aircraft. Even more detailed information can be obtained from an image at a higher NIIRS level.

The NIIRS was designed to refer to a wide range of image quality. An NIIRS level of 0 is defined as having no value for intelligence purposes; however, the definition of level 0 is open to debate. While, the upper end of the scale is defined by the best available imagery of a given type, it is not necessarily indicative of any specific operational system.

The NIIRS measures the information potential (i.e., interpretability of an image). This means that specific objects listed in the criteria, such as aircraft, need not be present, but the physical attributes of the image would have the specified information value if the specific object from the criteria were present.

The NIIRS relies on the experience of imagery analysts to be able to extrapolate or imagine how well criteria would be rendered if those features were present in the image to be rated. Because each rating refers to specific tasks the imagery analyst can or should be able to do, it has a more precise meaning than, for example, when such subjective words as *good* or *fair* are used. Thus, because imagery analysts can use the same yardstick to measure interpretability, judgments become more uniform.



The NIIRS takes into account the important factors that affect image interpretability. For example, image resolution, measured as ground resolved distance or ground sample distance, has a significant effect on interpretability; moreover, spatial resolution alone does not determine the NIIRS of an image, since sharpness, noise, and contrast also influence the NIIRS. These effects may be due to system parameters (e.g., optical quality, focal plane characteristics), acquisition conditions (e.g., sun angle, atmospheric haze), and exploitation conditions (e.g., duplicate film quality, softcopy monitor quality). By design, the NIIRS is independent of a particular imaging system. See table D-1 for a listing of NIIRS ratings and ranges.

**Table D-1. National Imagery Interpretability Rating Scale Ranges.**

NIRS Rating	Range in Meters
0	N/A
1	Over 9.0
2	4.5–9.0
3	2.5–4.5
4	1.2–2.5
5	0.75–1.2
6	0.4–0.75
7	0.2–0.4
8	0.1–0.2
9	Less than 0.1

---

## PRINCIPAL USES OF THE NATIONAL IMAGERY INTERPRETABILITY RATING SCALE

There are several primary uses for the NIIRS, including—

- Communicating imagery interpretability. (Can this image answer the intelligence requirement, both now and when archived?)
- Developing collection requirements. (Can an imagery system collect the required information? Can the currently available imagery missions collect the information?)
- Assessing mission collection satisfaction. (Does the image satisfy the intelligence requirement?)
- Assessing technical performance. (Is the imagery system working as planned?)

---

## PROCEDURE FOR ASSIGNING THE NATIONAL IMAGERY INTERPRETABILITY RATING SCALE RATING LEVELS CRITERIA

The NIIRS criteria are expressed in terms of how one is able to *detect, identify, or distinguish between* objects, features, or activities. *Detect* is the capability to find or discover the presence or existence of an installation, object, activity, or item of intelligence interest based on its general

shape (configuration) and on other contextual information in the scene. Some level of identification is implied in detection, so that the relatively gross feature or item detected can be properly named or classified. *Identify* is the capability to name an object by type or class based primarily on its configuration and detailed components. As used in NIIRS, identification is based on the observation of actual physical detail and not through information from other sources. *Distinguish between* is the capability to determine that two detected objects are of different types or classes based on one or more distinguishing features.

The following guidelines allow NIIRS to be used to communicate image interpretability, evaluate mission performance, and plan for new imagery systems:

- When assigning an NIIRS level, the imagery analyst should evaluate a target within an imagery segment or the entire area on the segment, as necessary, to meet the imagery analyst's task. The imagery analyst will assign an NIIRS level that best characterizes the overall interpretability of the target or area.
- The imagery analyst should neither ignore nor emphasize exceptionally good or poor portions of the image segment.
- When considering clouds, shadows or other localized degradations, the imagery analyst should rate the target or area with NIIRS level 0 only when the degradation precludes using it for interpretation. If the AOI is degraded but interpretable, the imagery analyst should assign an NIIRS that best represents its interpretability.
- The imagery analyst should ignore shadows cast by individual items of intelligence interest.

---

## **PANCHROMATIC NATIONAL IMAGERY INTERPRETABILITY RATING SCALE, OCTOBER 2008**

### **Air Order of Battle**

Rating Level 0: not applicable.

Rating Level 1: not applicable.

Rating Level 2:

- Distinguish between taxiways and runways at medium to large airfields.
- Identify individual revetments/hardened aircraft bunkers.
- Detect the presence of large airfields by the configuration of the facility (e.g., petroleum, oils, and lubricants [POL] storage, major support facilities, and runways).

Rating Level 3:

- Identify the wing configuration (e.g., straight, swept, delta) of all large aircraft (e.g., 707, 747, BEAR, BLACK JACK).
- Detect the presence of small fighter aircraft.

- Detect weapons storage areas by their physical security and configuration (e.g., 5 or more buildings/bunkers).
- Identify a control tower at an airfield.
- Detect radar sites (e.g., ground control intercept, ground controlled approach, and instrument landing system) at an airfield.

Rating Level 4: identify a BADGER, BACKFIRE, or CANBERRA by overall configuration.

Rating Level 5:

- Identify the propellers on transport aircraft (e.g., RS-COOT, COKE, CURL; CA-DASH 7, BUFFALO; INT-F27).
- Detect canvas covering on small fighter aircraft.
- Identify small fighter aircraft by type (e.g., RS-FLOGGER, FISHBED; US F-16; INT-TORNADO, JAGUAR; FR-SUPER ENTENDARD, MIRAGE).
- Identify medium helicopters (e.g., RS-HIP, HIND; US-Blackhawk; FR-SUPER FRELON, PUMA).

Rating Level 6:

- Identify dummy fighter aircraft by observation of discrepancies in wing sweep, root chord, or other features.
- Detect the presence of missiles loaded onto medium or large fighter aircraft.
- Distinguish between FITTER-A and other FITTER models by the number of wing fences.
- Identify individual approach lights at the end of a runway.

Rating Level 7:

- Detect canard on missiles carried on fighter aircraft.
- Distinguish between fairings, bulges, and antennas on fighter-sized aircraft.
- Identify the individual steps on a mobile passenger stairway.
- Detect canopy seam on small fighter aircraft (e.g., RS-FLOGGER, FISHBED; US F-16; INT-TORNADO, JAGUAR; FR-SUPER ENTENDARD, MIRAGE).
- Identify all structural lines, including butt joints, lap joints, rivet lines, and weld seams on large commercial or military transports (e.g., 747, Condor, C-5, AIRBUS 340).

Rating Level 8:

- Identify separate rungs on cockpit ladders.
- Detect elements internal to the cockpit (e.g., seat, other cockpit components).

Rating Level 9: not applicable.

**Cultural Order of Battle**

Rating Level 0: interpretability of the imagery is precluded by obscuration, degradation, or very poor resolution.

Rating Level 1: identify a small cluster of houses in a rural area by overall pattern.

Rating Level 2: detect individual two or three story buildings.

Rating Level 3:

- Detect trains or strings of standard rolling stock on railroad tracks (not individual cars).
- Detect large vehicles (e.g., trucks/buses) on highways.
- Detect rows of vehicles parked in a parking area.

Rating Level 4:

- Distinguish between rail tank cars, box cars, and gondola cars.
- Distinguish between large trucks and buses.

Rating Level 5:

- Identify the front windshield on a light-colored automobile.
- Identify trucks as cab-over-engine or engine-in-front.
- Detect (but not necessarily distinguish) cattle, camels, horses, and similar sized animals in open areas.

Rating Level 6:

- Detect a sunroof on a light-colored automobile.
- Detect people on sidewalks or market areas (including the shadows cast by people).
- Detect individual oil drums/55-gallon barrels.

Rating Level 7:

- Determine the presence of a luggage rack on the roof of a light colored vehicle.
- Determine the direction a railroad switch is set based upon rail position.

Rating Level 8:

- Identify the arms and legs on an individual.
- Distinguish between a person on a motorcycle and a person on a motor scooter.
- Identify the ribbing in the bed of a pick-up truck.

Rating Level 9:

- Distinguish hands/feet from limbs.
- Distinguish between types of military small arms being carried by an individual (e.g., rifle or rocket propelled grenade [RPG]).
- Identify farm or construction tools by general shape (e.g., shovel, pitchfork, pick, ax, sledge hammer).

### **Electronic Order of Battle**

Rating Level 0: not applicable.

Rating Level 1: not applicable.

Rating Level 2: not applicable.

Rating Level 3: identify radar/guidance areas of a SAM site, based on configuration.

Rating Level 4: identify the presence of a SATCOM site (Orbit A) by the presence of large SATCOM dishes (10 m or greater in size).

Rating Level 5:

- Detect civilian SATCOM dish (approx 1.62 m) on a rooftop.
- Detect a building-mounted VHF communication antenna.
- Identify the individual posts in a rhombic or quadrant array.
- Distinguish between TALL KING A, B, C, and D radars.

Rating Level 6:

- Distinguish between an ODD PAIR and an ODD GROUP by the antenna placement on the van.
- Detect the leveling/transport equipment on a TIN SHIELD radar.
- Identify the leveling/transport equipment on a BARLOCK or BACKTRAP radar.
- Distinguish between a SPOON REST C/D by the number of elements.

Rating Level 7:

- Identify the DATA LINK ANTENNA on BILL BOARD EW radar.
- Identify the feed structure of the target acquisition radar on the 2S6 when deployed.
- Distinguish between the individual FEED HORNS on a SQUARE PAIR radar.
- Identify whip antennas on box body vans and trailers.
- Detect individual elements of a Yagi array on a mobile electronics van.

Rating Level 8:

- Identify feed horn on small dish antenna (1.7 m or smaller in size).
- Identify framework on rear sides of CLAM SHELL parabolic dish.

Rating Level 9: not applicable.

### **Ground Order of Battle**

Rating Level 0: not applicable.

Rating Level 1: not applicable.

Rating Level 2: not applicable.

Rating Level 3: identify the areas of a ground forces installation (e.g., living areas, athletic fields, motor pools, parade grounds, obstacle course).

Rating Level 4:

- Identify riveted bunkers at a ground forces facility.
- Identify an AAA gun site.
- Detect a small convoy of civilian vehicles (cars, pick-ups, sport utility vehicles).

Rating Level 5:

- Identify tracked vehicles by general type, when in groups.
- Detect the gun tube on large field artillery guns.

Rating Level 6: identify the shape of a tank turret as round, elliptical, or angular.

Rating Level 7:

- Identify gun barrels on 2S6.
- Distinguish between tracks made by wheeled and tracked vehicles.
- Identify a ZSU-23/4 self-propelled anti-aircraft gun by the GUN DISH radar.

Rating Level 8:

- Detect a stack of military small arms (e.g., rifles, shoulder-fired weapons).
- Identify type of muzzle brake on towed field guns as multiple baffles.
- Identify individual grates in engine vents on tanks and armored personnel carriers.
- Identify the muzzle brake perforations on a D-30 howitzer.
- Detect a person carrying military small arms (e.g., rifle, RPG).

Rating Level 9:

- Identify the type of clothing (e.g., civilian attire or military uniform) on an individual.
- Identify shoulder-fired weapons (e.g., RPG/SA-7/14, REDEYE, STINGER).
- Detect whether an individual is wearing external body armor.
- Read tactical vehicle markings.
- Distinguish between types of military small arms (e.g., rifle or RPG) being carried by an individual.

### **Missile Order of Battle**

Rating Level 1: not applicable.

Rating Level 2: not applicable.

Rating Level 3:

- Detect a mobile intercontinental ballistic missile (ICBM) or an intermediate-range ballistic missile base by patterns of buildings and roads.

- Detect a SAM support facility for SA-2/CSA-1 missiles on the basis of its configuration.
- Identify a major missile test range (e.g., Tyuratam) by the presence of roads with wide radius curves, railroad loading docks, and the presence of heavy equipment, such as missile gantries.
- Detect a launch complex at a known missile test range.
- Identify a SA-10 A/B launch site based on site configuration.
- Identify radar and guidance areas at a SAM site by the site configuration, mounds, and presence of numerous concrete aprons.

Rating Level 4:

- Distinguish between an occupied and an unoccupied fixed SAM site.
- Detect a security fence erected around a missile launch site or transporter.
- Detect a field deployed SAM unit on the basis of equipment types present (e.g., launcher, missile, transloader).
- Detect individual single-bay garages at SS-25/27 bases.

Rating Level 5:

- Detect an erected missile on a short-range ballistic missile (SRBM)/medium-range ballistic missile transporter-erector-launcher (TEL) missile platform.
- Distinguish between open and closed sliding roofs on a single-bay garage at an SS-25/27 mobile missile base.
- Identify propellant/warhead/oxygen (26-m), hydrogen (44-m), fuel and oxidizer containers/canisters/tanks.
- Distinguish between mobile missile TELs and missile support vans in a known support base, when not covered by camouflage.
- Identify missile transporter vehicles with prime movers.

Rating Level 6:

- Identify individual SA-3, missiles on launchers.
- Identify an SA-2/CSA-1 transporter by overall configuration and details of chassis construction.
- Distinguish between SA-6 TEL and its associated STRAIGHT FLUSH radar when in travel mode.
- Identify mobile-tracked/wheeled SAM equipment by model (e.g., RS SA-6, SA-13, SA-9, SA-8; US-CHAPARRAL; FR-CROTALE; INT-ROLAND).
- Identify an SA-2 or CSA-1 missile by the presence and relative positions of wings and control fins.

Rating Level 7:

- Identify exhaust nozzle on an SA-5 solid fuel booster.
- Detect support bands on a SA-12 (types A and B) canister.
- Identify the hinge line on the control surface of sustainer fins of an SA-3.
- Identify a MOD III or IV SA-2 missile by sustainer fin tip chord variations.

Rating Level 8:

- Identify joints and welds on a TEL and radar.
- Identify seams, welds, joints, and construction lines on a No-Dong class medium-range ballistic missile.
- Identify factory markings on a missile canister to determine possible model number or dummy SA-5 missile.
- Identify screws and bolts on missile components.

Rating Level 9: not applicable.

### **Naval Order of Battle**

Rating Level 1: not applicable.

Rating Level 2:

- Detect the presence of a large ocean-going vessel in open water.
- Detect a large shallow-water marina.
- Detect a mid-sized port facility.

Rating Level 3:

- Detect small boats (e.g., fishing vessels, small combatants, patrol boats).
- Distinguish between naval and civilian port facilities by type and configuration of large functional areas.
- Identify a dry dock at a known port facility.
- Identify a large surface ship in port by type (e.g., auxiliary ship, combatant, noncombatant/merchant).
- Identify aircraft carriers by the size of the ship and the shape of the deck.

Rating Level 4:

- Identify a Soviet ship as either a cruiser or a destroyer by its relative size and hull shape.
- Identify a TYPHOON in port or at anchorage.
- Determine if ship holds are open or closed.
- Detect aircraft on an aircraft carrier.
- Distinguish between a freighter and a tanker on the basis of equipment on deck.
- Identify cranes at a port by type (e.g., jib, gantry, shear leg).

Rating Level 5:

- Distinguish between fleet ballistic missile submarines and other classes of submarines (e.g., attack submarine, nuclear attack submarine, cruise missile submarine).
- Identify a KASHIN-class destroyer by the twin pair of square smoke stacks.
- Detect the presence of a medium-caliber bow gun on a destroyer.



Rating Level 6:

- Identify SAM launch tubes or canisters on combatants (e.g., SA-N-3 GOBLET).
- Detect a BANDSTAND communications system on a SOVREMENNY-class ship.
- Identify missile tracking and control radars on guided missile cruisers/destroyers (e.g., RS – TOP DOME, FRONT DOME, KITE SCREECH).
- Identify the 12 individual hatch covers of inclined launched SA-N-6 forward of superstructure on KIROV [Soviet tank]-class.
- Identify individual gun barrels on a KIROV.
- Identify missile doors on cruise missile submarines, nuclear or fleet ballistic-missile submarines.

Rating Level 7:

- Detect the gun turret hatches.
- Detect the presence of personnel on deck.
- Identify individual posts and rails of protective railing around the perimeter of the deck.
- Identify the hull numbers on a Iranian COMBATTANTE IIB-class PTG [guided-missile patrol craft] (also known as: KAMAN P-227 SHAMSHIR).
- Identify detail on torpedo tubes (e.g., banding).
- Identify individual elements of weapons and electronics systems (e.g., feed horns, muzzle breaks, screens, feed mounts).
- Identify winch cables on deck-mounted cranes.
- Identify the configuration (e.g., shape, number of blades) of a submarine propeller in dry dock.

Rating Level 8:

- Identify mounting rings on the life support/rescue canisters.
- Identify ship's pendant number on life rings mounted on bulkheads.
- Identify individual rungs on between-deck ladders.

Rating Level 9: not applicable.

---

## INFRARED NATIONAL IMAGERY INTERPRETABILITY RATING SCALE, APRIL 1996

Rating Level 0: interpretability of the imagery is precluded by obscurity, degradation, or very poor resolution.

Rating Level 1:

- Distinguish between runways and taxiways on the basis of size, configuration, or pattern at a large airfield.
- Detect a large (e.g., greater than 1 square km) cleared area in dense forest.
- Detect large oceangoing vessels (e.g., aircraft carrier, supertanker, KIROV) in open water.
- Detect large areas (e.g., greater than 1 square km) of marsh/swamp.

**Rating Level 2:**

- Detect large aircraft (e.g., C141, 707, BEAR, CANDID, CLASSIC).
- Detect individual large buildings (e.g., hospitals, factories) in an urban area.
- Distinguish between densely and sparsely wooded and open fields.
- Identify an SS-25 base by the pattern of buildings and roads.
- Distinguish between naval and commercial port facilities based on type and configuration of large functional areas.

**Rating Level 3:**

- Distinguish between large (e.g., C141, 707, BEAR, A300 AIRBUS) and small aircraft (e.g., FISHBED, L39).
- Identify individual thermally active flues running between the boiler hall and smokestacks at a thermal power plant.
- Detect a large air warning radar site based on the presence of mounds, revetments, and security fencing.
- Detect a driver training track at a ground forces garrison.
- Identify individual functional areas (e.g., launch sites, electronics area, support area, missile handling area) of an SA-5 launch complex.
- Distinguish between large (e.g., greater than 200 m) freighters and tankers.

**Rating Level 4:**

- Identify the wing configurations of small fighter aircraft (e.g., FROGFOOT, F-16, FISHBED).
- Detect a small (e.g., 50-m square) electrical transformer yard in an urban area.
- Detect large (e.g., greater than 10 m in diameter) environmental domes at an electronics facility.
- Detect individual thermally active vehicles in garrison.
- Detect thermally active SS-25 missile support vehicles in garrison.
- Identify individual closed-cargo hold hatches on large merchant ships.

**Rating Level 5:**

- Distinguish between single tail (e.g., FLOGGER, F-16, TORNADO) and twin tailed (e.g., F-15, FLANKER, FOXBAT) fighters.
- Identify outdoor tennis courts.
- Identify the metal lattice structure of large (e.g., approximately 75 m) radio relay towers.
- Detect armored vehicles in a revetment.
- Detect a deployed transportable electronics tower at an SA-10 site.
- Identify the stack shape (e.g., square, round, oval) on large (e.g., greater than 200 m) merchant ships.

**Rating Level 6:**

- Detect wing-mounted stores (e.g., air-to-surface missiles, bombs) protruding from the wings of large bombers (e.g., B-52, BEAR, BADGER).
- Identify individual thermally active engine vents atop diesel locomotives.
- Distinguish between a FIX FOUR and FIX SIX site based on antenna pattern and spacing.
- Distinguish between thermally active tanks and armored personnel carriers.
- Distinguish between a two-rail and four-rail SA-3 launcher.
- Identify missile tube hatches on submarines.

**Rating Level 7:**

- Distinguish between ground attack and interceptor versions of the MIG-23 FLOGGER based on nose shape.
- Identify automobiles as sedans or station wagons.
- Identify antenna dishes (smaller than 3 m in diameter) on a radio relay tower.
- Identify the missile transfer crane on an SA-6 transloader.
- Distinguish between an SA-2/CSA-1 and a SCUD-B missile transporter when missiles are not loaded.
- Detect mooring cleats or bollards on piers.

**Rating Level 8:**

- Identify the ram air scoop on the dorsal spine of FISHBED J/K/L.
- Identify limbs (e.g., arms, legs) on an individual.
- Identify individual horizontal and vertical ribs on a radar antenna.
- Detect closed hatches on a tank turret.
- Distinguish between fuel and oxidizer multisystem propellant transporters based on twin or single fitments on the front of the semitrailer.
- Identify individual posts and rails on deck edge life rails.

**Rating Level 9:**

- Identify access panels on fighter aircraft.
- Identify cargo (e.g., shovels, rakes, ladders) in an open bed, light-duty truck.
- Distinguish between BIRDS EYE and BELL LACE antennas based on the presence or absence of small dipole elements.
- Identify turret hatch hinges on armored vehicles.
- Identify individual command guidance strip antennas on an SA-2/CSA-1 missile.
- Identify individual rungs on bulkhead-mounted ladders.

---

## **RADAR NATIONAL IMAGERY INTERPRETABILITY RATING SCALE, APRIL 1999**

Rating Level 0: interpretability of the imagery is precluded by obscurity, degradation, or very poor resolution.

Rating Level 1:

- Detect field delineation based on vegetation differences.
- Identify golf courses.
- Detect natural surface runways (e.g., grass, bare earth) in open terrain.
- Detect shoreline quays outside of a port facility in absence of ships.
- Detect vessel (~300 ft long) at suspected narcotics transshipment point in open ocean.

Rating Level 2:

- Identify natural drainage pattern in tidal flats.
- Detect extent of recent flooding based on soil moisture differences.
- Detect windbreaks/hedgerows between fields.
- Identify composition of runway/taxiways/parking aprons (e.g., concrete, asphalt).
- Detect wetland areas unsuitable for mobile ICBM traffic.
- Detect submerged spoil field from dredging operations near a port facility.
- Detect the presence of offshore surface vegetation along a beach LZ.

Rating Level 3:

- Distinguish between fallow and abandoned fields.
- Detect effluent discharge into water from industrial facility.
- Distinguish between an open pit coal mine and a limestone quarry.
- Identify large cargo aircraft as military or commercial based on paint color/scheme.
- Detect rows of vehicles in a parking area.
- Identify beach terrain suitable for amphibious landing operations.

Rating Level 4:

- Detect vegetation stress/aging in narcotics crops in reported eradication area.
- Identify tennis court composition (grass, clay, or rubber/composite).
- Detect CCD efforts (cut vegetation, camouflage netting) at suspected coca processing facilities.
- Identify azimuth markings (numbers) on runway.
- Detect tanks and self-propelled guns in revetted positions.
- Detect blast marks from mobile- or silo-based ICBM launches on concrete.
- Detect presence of sea land containers on a ship's deck.
- Distinguish between coal and sand loaded onto a dumb barge.

**Rating Level 5:**

- Detect individual trees with indications of vegetation stress.
- Identify color of unfurled sails on sailboats (20 to 30 ft long).
- Distinguish between military and civilian helicopter paint schemes.
- Identify large ground forces' equipment by type (e.g., tanks, self-propelled guns, armored recovery vehicles).
- Detect foxholes by ring of spoil outlining hole.
- Detect the presence of sailors in formation on the deck of a large combatant during parade/review.
- Identify colors of stripes/deck markings on major surface combatants.

**Rating Level 6:**

- Detect a foot trail through tall grass.
- Identify colored bands on rail cars.
- Identify support personnel performing maintenance while on an aircraft.
- Identify the colors of stack markings on merchant ships.
- Detect the presence of an algae line on the dark surface of a submarine hull.

**Rating Level 7:**

- Identify medium farm animals by type (e.g., sheep, hogs, goats).
- Distinguish road safety signs by color.
- Detect wing flaps and other articulating surfaces on fighter aircraft.
- Distinguish between open and closed hatches on the turret of an MTLB [Russian transport combat vehicle] chassis.
- Detect windsock on helicopter deck.
- Identify canvas covering the muzzles of an ADMG630 gun.

**Rating Level 8:**

- Detect different species of trees based on color variation.
- Detect a soccer ball in play at a sports field.
- Detect a person (with helmet) in a fighter aircraft with the canopy open.
- Identify turret-mounted smoke grenade dischargers on an M1 main battle tank.
- Detect color-pattern-of-life rings on surface vessels.

**Rating Level 9:**

- Identify rock layers in sedimentary outcropping.
- Identify and count cleats on a civilian ski boat.
- Detect red/green wing lights on fighter aircraft.
- Distinguish between armed soldiers and armed civilians based on clothing.
- Identify the draft marks numbers on submarine bows.

---

## MULTISPECTRAL NATIONAL IMAGERY INTERPRETABILITY RATING SCALE, JANUARY 2001

Rating Level 0: interpretability of the imagery is precluded by obscuration, degradation, or very poor resolution.

Rating Level 1:

- Detect field delineation based on vegetation differences.
- Identify golf courses.
- Detect natural surface runways (e.g., grass, bare earth) in open terrain.
- Detect shoreline quays outside of a port facility in absence of ships.
- Detect vessel (~300 ft long) at suspected narcotics transshipment point in open ocean.

Rating Level 2:

- Identify natural drainage pattern in tidal flats.
- Detect extent of recent flooding based on soil moisture differences.
- Detect windbreaks/hedgerows between fields.
- Identify composition of runway/taxiways/parking aprons (e.g., concrete, asphalt).
- Detect wetland areas unsuitable for mobile ICBM traffic.
- Detect submerged spoil field from dredging operations near a port facility.
- Detect the presence of offshore surface vegetation along a beach LZ.

Rating Level 3:

- Distinguish between fallow and abandoned fields.
- Detect effluent discharge into water from industrial facility.
- Distinguish between an open pit coal mine and a limestone quarry.
- Identify large cargo aircraft as military or commercial based on paint color/scheme.
- Detect rows of vehicles in a parking area.
- Identify beach terrain suitable for amphibious landing operations.

Rating Level 4:

- Detect vegetation stress/aging in narcotics crops in reported eradication area.
- Identify tennis court as being composed of grass, clay, or rubber/composite.
- Detect CCD efforts (cut vegetation camouflage netting) at suspected coca processing facilities.
- Identify azimuth markings (numbers) on runway.
- Detect tanks and self-propelled guns in revetted positions.
- Detect blast marks from mobile or silo-based ICBM launches on concrete.
- Detect presence of sea land containers on a ship's deck.
- Distinguish between coal and sand loaded on dumb barge.

## Rating Level 5:

- Detect individual trees with indications of vegetation stress.
- Identify color of unfurled sails on sailboats (20 to 30 ft long).
- Distinguish between military and civilian helicopter paint schemes.
- Identify large ground forces' equipment by type (e.g., tanks, self-propelled guns, armored recovery vehicles).
- Detect foxholes by ring of spoil outlining hole.
- Detect the presence of sailors in formation on the deck of a large combatant during parade/review.
- Identify colors of stripes/deck markings on major surface combatants.

## Rating Level 6:

- Detect a foot trail through tall grass.
- Identify colored bands on rail cars.
- Identify support personnel performing maintenance while on an aircraft.
- Identify the colors of stack markings on merchant ships.
- Detect the presence of an algae line on the dark surface of a submarine hull.

## Rating Level 7:

- Identify medium farm animals by type (e.g., sheep, hogs, goats).
- Distinguish road safety signs by color.
- Detect wing flaps and other articulating surfaces on fighter aircraft.
- Distinguish between open and closed hatches on the turret of an MTLB chassis.
- Detect windsock on helicopter deck.
- Identify canvas covering the muzzles of an ADMG630 gun.

## Legend for Appendix D

CA–Canada

FR–France

INT–International

RS–Russia

US–United States of America

---

# APPENDIX E

## VIDEO NATIONAL IMAGERY INTERPRETABILITY RATING SCALE

The Video NIIRS is used to document the subjective quality scale for airborne motion imagery in the visible spectrum. When used in this context, “quality” refers to the interpretability or “intelligence value” of a video clip; it is not a measure of esthetic value. The Video-NIIRS is designed to account for differences in resolution, sampling rate (frame-rate), scene complexity, and human activity or behavior (see Motion Imagery Standards Board (MISB) Recommended Practice, Video-National Imagery Interpretability Rating Scale, RP0901.1, approved for public release, NGA Case 09-13715, June 2011).

---

### SCALE DESIGN

The Video-NIIRS is designed to be log-linear in resolution space, meaning that each successive Video-NIIRS level from zero (lowest) to nine (highest) represents a halving of ground sampling distance (i.e., doubling the resolution from Video-NIIRS 3 to Video-NIIRS 4 and so on). It provides criteria tasks for the seven orders of battle or content domains: air forces, ground forces, electronics, missile, naval forces, culture, and security. Some Video-NIIRS levels have more than one criterion example per OOB/content domain.

Each written criterion contains specific components separated by a bullet point to add clarity and aid readers understanding of the content. These components are arranged for each criterion as follows:

- Analyst task. (Verbs like ‘track’ or ‘confirm’ infer an analyst’s ability to do so consistently over an ensemble of clips of equal quality.)
- Object of interest.
- Associated activity or behavior.
- Environment.
- Object reference examples.

The analyst rates a video clip by determining if he or she can perform the most relevant criteria listed for a particular Video-NIIRS level, but cannot do the same for the next higher level. In other words, if an analyst can perform the Video-NIIRS 4 criteria on a video clip, but cannot perform the Video-NIIRS 5 criteria, the analyst rates the video clip Video-NIIRS level 4.



---

## USING THE VIDEO NATIONAL IMAGERY INTERPRETABILITY RATING SCALE IN ANALYST EVALUATIONS

Video-NIIRS ratings are a measure of interpretability (intelligence value). The ability (or inability) to perform the tasks provided in Video-NIIRS criteria is either possible or it is not possible; therefore, the rating should be given using a whole number. There can and will be significant differences in the visual preferences an analyst may have regarding videos of the same Video-NIIRS rating level. While these preferences may be undefined, they are, by definition, not measures of interpretability. They do, however, represent human factors that can impact the quality of analysis and should be addressed.

These undefined visual preferences are not task based and can be assessed in quality studies using the double-stimulus continuous quality scale method described in International Telecommunications Union-Radiocommunication Sector BT.500-12, *Methodology for the Subjective Assessment of the Quality of Television Pictures*. Any study using Video-NIIRS to extract analyst ratings that are fractional or decimal in nature may not meet the criteria for construct validity.

---

## MOTION IMAGERY DEFINED

Motion imagery is defined as imagery [a likeness or representation of any natural or man-made feature or related object or activity] utilizing sequential or continuous streams of images that enable observation of the dynamic, temporal behavior of objects within the scene. Motion imagery temporal rates are nominally expressed in frames per second and must be sufficient to characterize the desired dynamic phenomena. Motion imagery is defined as including metadata and nominally beginning at frame rates of 1-frame per second (expressed here in Hertz) or higher within a common field of regard. Full motion video falls within the context of these standards (see *Motion Imagery Standards Profile (MISP), version 6.4*).

---

## VIDEO NATIONAL IMAGERY INTERPRETABILITY RATING SCALE CRITERIA BY QUALITY LEVEL

### Video National Imagery Interpretability Rating Scale: Level 2

At Video-NIIRS level two, motion imagery data lacks sufficient spatial and/or temporal resolution for intelligence surveillance. For example, high EO-NIIRS still imagery would be rated Video-NIIRS two regardless of spatial resolution, as it provides no dynamic content. High frame-rate video of a resolution too low to discern most human activity would be rated Video-NIIRS zero because it provides insufficient spatial content.

Assuming a suitably wide field of view, gross spatial and temporal resolution motion imagery data could support monitoring of commercial sea lanes (tracking tankers and other large surface ships) as well as conducting macro-pattern analysis of populated regions. Such data may also support dynamic earth sciences, such as oceanography and meteorology.

**Video National Imagery Interpretability Rating Scale: Levels 3–11**

Table E-1 explains levels 3 through 11 of the Video-NIIRS, according to the Recommended Practice, Video-National Imagery Interpretability Rating Scale.

Order of Battle	Video NIIRS Level 3
<b>AIR FORCES</b>	Track movement of an identified heavy cargo/passenger aircraft during taxi or tow at a primary airfield/airport installation (aircraft length: 50 m or more, e.g., MD11, A300, B747, B767, DC8).  Note: Under-resolved smaller aircraft may be evident based on movement or behavior.
<b>ELECTRONICS</b>	Track the movement of a convoy of unidentified radar/radar support vehicles in column formation or road march traveling on an open roadway in the vicinity of a known EW or SAM radar site (four to eight vehicles with total column length 50 m or longer).  Note: Vehicles comprising the convoy and other under-resolved vehicles are evident based on movement or behavior.
<b>GROUND FORCES</b>	Track the movement of an unidentified military convoy company sized or larger consisting of armor or mechanized infantry in a column or “road march” on an open highway/roadway (four to eight vehicles with total column length 50 m or longer).  Note: Vehicles comprising the convoy and other under-resolved vehicles are evident based on movement or behavior.
<b>MISSILE</b>	Track the movement of a convoy of ICBM transporter and support vehicles during deployment or road march on an improved road near missile base, launch site, or silo (Dong Feng 4, Taepodong 2, Agni V: transporter with support vans—convoy length 60 m or longer).  Note: Support vehicles comprising the convoy and other under-resolved vehicles may be evident based on movement or behavior.
<b>NAVAL FORCES</b>	Track the movement of an unidentified coastal patrol craft conducting normal operations at sea several miles beyond a harbor or port (e.g., US Cyclone Class: average 58 m length, 8 m beam).  Note: Under-resolved smaller craft may be evident based on movement, behavior, or wake.
<b>CULTURE</b>	Track the movement of an oversized heavy hauler tractor and trailer driving in a convoy on the open highway (movers of houses, cranes, drilling and large earth moving equipment), such as 100-ton, big-rig tractors with multi-axle lowboy special use trailer, total length 40 m to 50 m).  Note: Under-resolved smaller trucks may be evident based on behavior.
	Track the movement of an oversized container carrying flatbed railcar in motion at a rail yard (46 m length flatbed rolling stock).  Note: Under-resolved smaller trucks or rolling stock may be evident based on behavior.
<b>SECURITY</b>	Track the movement of an unidentified convoy of three or more sea/land containers driving in a column formation exiting a rail yard or port facility, such as big-rig tractors hauling sea/land containers, total convoy length 50 m or more.  Note: Under-resolved smaller trucks may be evident based on behavior.

Order of Battle	Video NIIRS Level 4
<b>AIR FORCES</b>	<p>Track movement of an identified large fighter/attack aircraft during taxi or tow at a primary airfield/airport installation (aircraft length: 15 m or longer; e.g., F-15, F-16, Eurofighter, F-22, MIG-29, F-35).</p> <p>Note: Under-resolved smaller aircraft may be evident based on movement or behavior.</p>
	<p>Confirm rotor wash effects of an unidentified light/medium helicopter on tall grass, sand, or dirt during takeoff or landing in the field, at a tactical LZ or forward arming and refueling point (diameter of disturbance: 25 m to 50 m).</p> <p>Note: The helicopter causing rotor wash, as well as other under-resolved aircraft or ground support vehicles may be evident based on movement or behavior.</p>
<b>ELECTRONICS</b>	<p>Confirm movement of large EW radar or signal intercept vehicles and vans with trailers in column/convoy or deploying at or near a known improved electronics site (large flatbed tractor-trailer with mast mounted antennas: 20 m vehicle length).</p> <p>Note: Under-resolved smaller vehicles (vans or cars) may be evident based on behavior.</p>
<b>GROUND FORCES</b>	<p>Track the movement of individual, tracked engineering vehicles and wheeled prime mover/trailer combinations during tactical road march/deployment in the field or on an unpaved road (e.g., engineer recovery vehicles, scissor bridges, tank carriers: average length 15 m to 25 m).</p> <p>Note: Under-resolved smaller vehicles (light trucks, support vehicles) may be evident based on behavior.</p>
<b>MISSILE</b>	<p>Track the movement of an individual ICBM while being transported overland on an improved road near missile base, launch site or silo (Dong Feng 4, Taepodong 2, Agni V: airframe length approximately 20–30 m).</p> <p>Note: Under-resolved smaller support vehicles may be evident based on behavior.</p>
<b>NAVAL FORCES</b>	<p>Track the movement of an unidentified small near-shore or inter-coastal patrol boat conducting normal operations in the coastal or near-shore littoral environment (e.g., US Mark V Special Operations Craft: approximately 85 ft in length, 6 m beam).</p> <p>Note: Under-resolved smaller boats may be evident based on movement, behavior, or wake.</p>
	<p>Track movement of an identified large fighter/attack aircraft during shipboard air operations on the deck of an attack aircraft carrier (aircraft length: 15 m or more, e.g., F-18, Harrier, F-35).</p> <p>Note: Under-resolved smaller aircraft or deck handling equipment may be evident based on movement or behavior.</p>
<b>CULTURE</b>	<p>Track the movement of a large freight/transport vehicle type: 18-wheel tractor-trailer rig, metro-bus, large recreational vehicle driving independently on an urban road in light traffic (commercial freight and public transports: 15 m to 23 m in length).</p> <p>Note: Under-resolved smaller vehicles (cars, sport utility vehicles) may be evident based on behavior.</p>
<b>SECURITY</b>	<p>Track the movement of an individual sea/land container tractor-trailer rig driving independently on a highway in light traffic (commercial freight transports: 15 m to 23 m long).</p> <p>Note: Under-resolved smaller vehicles (cars, sport utility vehicles) may be evident based on movement or behavior.</p>

Order of Battle	NIIRS Level 5
<b>AIR FORCES</b>	<p>Confirm rotation of main rotor blades on an identified medium helicopter during warm up or taxi at a primary airfield/airport installation (rotor-blade diameter: 12 m to 18 m; e.g., RAH66, KA50, AH64, NH90, UH60).</p> <p>Note: Under-resolved ground crew or grouped dismounts may be evident based on movement or behavior.</p>
<b>ELECTRONICS</b>	<p>Confirm movement of a large electronics vehicle's mast and mast-mounted antenna while being raised or lowered at a known improved electronics site (vehicle-/trailer- mounted mast and antenna: mast height 20 m or more).</p> <p>Note: Under-resolved crew members or grouped dismounts may be evident based on movement or behavior.</p>
<b>GROUND FORCES</b>	<p>Confirm the rotation of the turret on a main battle tank as the main gun slews during training, live fire exercise, or combat at a gunnery range, field deployment site, or battle zone (e.g., M1-A2, Challenger-2, Leopard-2, T-80: average chassis 9 m long by 3.5 m wide).</p> <p>Note: Under-resolved dismounts may be evident based on movement or behavior.</p>
<b>MISSILE</b>	<p>Track the movement of an individual mobile SRBM while being transported or during launch preparations on or near a road in the vicinity of a surveyed launch site (mobile Fajr-5 or SCUD: airframe length approximately 10 m to 15 m).</p> <p>Note: Under-resolved dismounts may be evident based on movement or behavior.</p>
<b>NAVAL FORCES</b>	<p>Track the movement of a light riverine/deep inter-coastal patrol boat during operations/patrol in the riverine environment (e.g., light patrol boat or rigid inflatable boat 8 m to 11 m long, 2.5 m to 3 m beam).</p> <p>Note: Under-resolved personal water-craft or swimmers may be evident based on movement, behavior, or wake.</p>
<b>CULTURE</b>	<p>Track the movement of a car, sport utility vehicle, van, or light truck driving independently on roadways in medium traffic (mid and full size cars and trucks: 5 m to 6 m in length).</p> <p>Note: Under-resolved two-wheeled vehicles or dismounts may be evident based on movement or behavior.</p>
<b>SECURITY</b>	<p>Track the movement of a suspect car, sport utility vehicle, or light truck driving erratically/aggressively or employing evasive driving measures on roadways in light traffic (mid and full size cars and trucks: 5 m to 6 m in length).</p> <p>Note: Under-resolved two-wheeled vehicles or dismounts may be evident based on movement or behavior.</p>
Order of Battle	Video NIIRS Level 6
<b>AIR FORCES</b>	<p>Confirm movement of control surfaces on an identified heavy cargo/passenger aircraft during preflight checkout or taxi at a primary airfield/airport installation (flaps and ailerons on aircraft having wingspan of 112 m or more; e.g., MD11, A300, B747, B767, DC8).</p>
<b>ELECTRONICS</b>	<p>Confirm the movement of a vehicle- or building- mounted parabolic mesh antenna as it slews or rotates at a known improved electronics site (e.g., parabolic mesh antennas, approximate diameter of 30 ft).</p>
<b>GROUND FORCES</b>	<p>Confirm the movement/operation of crew-served or vehicle-mounted anti-aircraft systems as the launchers/guns slew to an aimed firing position during operation at a riveted, defensive field position (e.g., Avenger, Tunguska M1, Rapier: launcher pods average 2 m–3 m long).</p>
<b>MISSILE</b>	<p>Confirm the movement of vans, cranes/hoists supporting a mobile SRBM during maintenance, transloading, deployment preparation at a garrison or field maintenance facility (e.g., support vans and equipment lengths approximately 3 m to 5 m).</p>

<b>Order of Battle</b>	<b>Video NIIRS Level 6–Continued</b>
<b>NAVAL FORCES</b>	Confirm the movement of a deck-mounted defensive armament as it slews and elevates to aim and fire on the surface combatant, cruiser, or frigate (e.g., 20 mm and 40 mm guns and mounts/turrets, average diameter of 5 m to 6 m).
<b>CULTURE</b>	Track the movement of a full sized motorcycle driving independently on roadways in medium traffic (large cruising motorcycle, 2.5 m in length).  Note: Under-resolved dismounts may be evident based on behavior.
<b>SECURITY</b>	Track the general movement of groups (25+) of under-resolved dismounts as they cross the street at a busy intersection in an open public square or pedestrian thoroughfare (i.e., commuters, shoppers, or event participants).
<b>Order of Battle</b>	<b>Video NIIRS Level 7</b>
<b>AIR FORCES</b>	Confirm the movement of control surfaces on an identified light transport aircraft during preflight checkout or taxi at an international or municipal airfield/airport installation (flaps and ailerons on aircraft having wingspan of 18 m or less; e.g., Beech Model 200 Super King Air, flaps approximately 0.75 m to 2.5 m in length).  Confirm heat distortion waves/effects from the exhaust plume of a large fighter jet during warm up or taxi at a secondary/dispersal airfield (diameter of visible distortion approximately 5 m to 10 m).
<b>ELECTRONICS</b>	Confirm movement of large access panels as they are opened or closed on a site or field deployed electronics/radar van or mobile hut (individual panels of 2 m to 2.5 m diameter).
<b>GROUND FORCES</b>	Confirm the movement/operation of crew-served or vehicle-mounted antiarmor weapons as the launcher is aimed or slews to its firing position during live fire exercise or combat at a gunnery range, field deployment site, or battle zone (TOW 2, Milan, Javelin: launcher 1 m to 1.5 m in length).
<b>MISSILE</b>	Confirm the movement of the crew supporting a mobile SRBM during maintenance or launch preparations at a maintenance facility or launch site (individuals of average height and weight).
<b>NAVAL FORCES</b>	Confirm the movement of unidentified deckborne objects as they are dumped over the side or stern of any surface ship or fishing vessel at sea (e.g., container drums, bales, crab traps 2 m to 2.5 m diameter).
<b>CULTURE</b>	Confirm the movement of a car hood/bonnet or deck-lid/trunk/boot as it is opened or closed while stopped along a roadway or street (conventionally hinged midsize car hood or deck-lid).
<b>SECURITY</b>	Isolate pockets of unrest/potential violence in large groups (50+) of otherwise peaceful dismounts as they demonstrate or protest in an open public square or pedestrian thoroughfare (i.e., political demonstrators, bystanders, observers, security forces).
<b>Order of Battle</b>	<b>Video NIIRS Level 8</b>
<b>AIR FORCES</b>	Confirm the movement of individual pilot(s) or flight crew conducting external pre-flight checkout at a tactical/dispersal airfield or forward operating base (individuals of average height and weight).
<b>ELECTRONICS</b>	Confirm movement of individual crewmembers entering or exiting hatches or climbing ladders on a site- or field-deployed electronics/radar van or mobile hut (individuals of average height and weight).
<b>GROUND FORCES</b>	Confirm the movement of an individual holding a shoulder fired anti-aircraft missile as the launcher is raised to the aimed firing position in the field, in a defensive position, or in the vicinity of an airfield or airport approaches (Stinger, SA-16/18-IGLA: launch tube average length is 1.7 m).
<b>MISSILE</b>	Track the movement of an individual member of a Katyusha rocket crew during transportation and deployment en route to/near a launch site (individuals of average height and weight).

<b>Order of Battle</b>	<b>Video NIIRS Level 8–Continued</b>
<b>NAVAL FORCES</b>	Confirm the movement of individual deck crew handling seaborne mines as they are readied for deployment off the stern of any surface ship/boat, especially a noncombatant modified/co-opted for terrorist or military use (seaborne mines, approximate 1 m in diameter).
<b>CULTURE</b>	Confirm the movement of a car door as it is opened or closed while stopped along a roadway or street (conventionally hinged midsized car door).
<b>SECURITY</b>	Isolate and track the movement of small subgroups (associates) in a larger crowd of people as they walk in an open public area or pedestrian walkway (i.e., subgroups of 2 to 5 individual pedestrians in a crowd of 20 or more, based on movement and proximity).
<b>Order of Battle</b>	<b>Video NIIRS Level 9</b>
<b>AIR FORCES</b>	Consistently track the movement of the body and arms of ground/flight crew member hand lock/unlock an external panel, hatch or compartment on any aircraft at any airfield or base (individuals of average height and weight).
<b>ELECTRONICS</b>	Consistently track the movement of an individual's body and arms while using an unidentified portable handheld communications device in an open public area or pedestrian walkway (individual of average height and weight holding device up to ear or bringing hands together for text entry).
<b>GROUND FORCES</b>	Consistently track the movement of the body and arms of an individual holding a long rifle or sniper rifle as the weapon is raised to an aimed firing position—either standing, sitting, or prone at a practice range, during live fire exercise, or during an engagement (e.g., Barrett M82-A1, Remington Model 700 series: 1 m to 2 m in overall length).
<b>MISSILE</b>	Consistently track the movement of an individual Katyusha crew member's body and arms during set up and launch preparation at a tactical launch site in a rural or urban environment (Individuals of average height and weight).
<b>NAVAL FORCES</b>	Consistently track the movement of an individual deck crew's body and arms as they conduct a patrol or operations on a light surface combatant; i.e., patrol boat (individual of average size and weight).
<b>CULTURE</b>	Consistently track the movement of a pedestrian's body and arms as he walks in a busy public area, market, or walkway (individual of average height and weight).
<b>SECURITY</b>	Confirm a conversation is underway based on the movement of the body and arms of participants as they walk or stand in an open public area or pedestrian walkway (i.e., subgroups of two to three individual pedestrians speaking among a meandering crowd of 20 or more).
<b>Order of Battle</b>	<b>Video NIIRS Level 10</b>
<b>AIR FORCES</b>	Confirm the movement of the hands and forearms of a ground crew/mechanic using an identified hand tool or power tool while servicing any aircraft or support vehicle at any airfield, base, or aircraft maintenance facility (individual of average size using socket wrench or power driver with length of 0.15 m to 0.3 m).
<b>ELECTRONICS</b>	Confirm movement of an individual's hands and forearms holding a visible handheld communications device in the process of sending/receiving information (e.g., speaking, text-messaging) in a busy public area or pedestrian walkway (cell phone or personal data assistant average diameter 0.1 m to 0.15 m).
<b>GROUND FORCES</b>	Confirm the movement of the hands and forearms of an individual holding a compact assault weapon or large frame handgun as the weapon is raised to an aimed firing position—either standing, crouched, or prone—at a practice range, during live fire exercise, or during an engagement (MP-5, AK74, Colt Commando, UZI, M-1911: 0.25 m to 0.8 m overall length).
<b>MISSILE</b>	Confirm the movement of an individual Katyusha crew member's hands and forearms while connecting leads/wires between rockets and trigger mechanism at a tactical launch site in a rural or urban environment (individuals of average height and weight).

Order of Battle	Video NIIRS Level 10–Continued
<b>NAVAL FORCES</b>	Confirm the movement of individual deck crew member’s forearms and hands as he performs weapons check of pedestal mounted arms on a patrol boat in a riverine environment (individual of average size and weight manning a mounted .50 cal. or MK19 grenade launcher).
<b>CULTURE</b>	Confirm the movement of a pedestrian’s forearms and hands as they make a purchase from a street vendor in a busy open market or square (individual of average height and weight, exchanging payment for goods).
<b>SECURITY</b>	Confirm an individual is speaking based on the movement of an individual’s head and mouth as they engage in a conversation in an open public area or pedestrian walkway (i.e., determine if a person is speaking based on head and mouth movement).
	Confirm the movement of an individual’s forearms and hands as they gesture or sign in an open public area or pedestrian walkway (i.e., confirm/read gestures or body language while subject is conversing, or partially interpret sign language).
	Confirm the functions of individuals based on the movement of body, head, forearms, and hands as a protected individual is moved to or from a vehicle/motorcade or in an open public area (i.e., isolate behavior to determine the function of individuals in a small group: armed security, principals, and VIPs).
	Confirm the exchange of a parcel based on the movement of the hands and forearms of two individual pedestrians as one walks past the other in a crowded public area or pedestrian walkway (i.e., confirm the exchange of a letter-sized envelope between two pedestrians in a crowd).
Order of Battle	Video NIIRS Level 11
<b>AIR FORCES</b>	Confirm the movement of the fingers/hand of a ground crew/mechanic changing the socket on a ratchet/socket wrench while servicing any aircraft or support vehicle at any airfield, base, or aircraft maintenance facility (socket able to fit in palm of workers hand).
<b>ELECTRONICS</b>	Confirm movement of an individual’s mouth/jaw while speaking into a Bluetooth wireless mobile phone earpiece in a crowded public area or pedestrian walkway (average-sized person wearing an over the ear device with internal or boom microphone, average diameter: 2.5 cm to 5.0 cm).
<b>GROUND FORCES</b>	Confirm the movement of the fingers and hands of an individual holding a fragmentation grenade as the weapon’s safety is released and the device is readied at a practice range, during live fire exercise, or during an engagement (spherical or cylindrical device, palm sized with metal pull ring/pin and spring loaded spoon: 6 cm to 8 cm diameter).
<b>MISSILE</b>	Confirm the movement of individual’s fingers and hands while aiming a shoulder-fired antitank missile as they release safeties and arm the device at a tactical position in a rural or urban environment (individuals of average height and weight holding AT-4 or RPG).
<b>NAVAL FORCES</b>	Confirm the movement of an individual combat swimmer’s hands and fingers as they check out and test scuba equipment on a light surface combatant; i.e., patrol boat near the littoral zone (individual of average size and weight).
<b>CULTURE</b>	Confirm the movement of a pedestrian’s hands and fingers as they make change or sort coins in a busy open market or square (individual of average height and weight, sorting coins in a change purse or the palm of one hand).
	Confirm the movement of a pedestrian’s hands and fingers as they communicate through sign language in an open public area (i.e., fully interpret sign language to include the spelling out of individual letters).

Order of Battle	Video NIIRS Level 11–Continued
SECURITY	Isolate and investigate an individual or group based on the movement of their hands, fingers, and face as they observe the movement of a protected individual from a crowd behind a rope line or police barrier (i.e., isolate behavior to determine if an individual or individuals pose an immediate threat to a VIP).
	Isolate and investigate an individual apparently burdened with significant concealed weight, based on his gait, posture, hands, fingers, and overall body language as he meanders into a crowd in a public square, market, or shopping mall (i.e., based on gait, determine if an individual is a public threat or concealing an explosive vest or belt).
	Isolate suspicious movement/behavior of the hands and fingers of a suspect individual or known operative as they leave an inconspicuous signal or message on a light pole or mailbox in a crowded urban street (i.e., traditional espionage tradecraft: a chalk mark or sticker on a predetermined location to signal a meeting or dead drop).

Legend:

cal—caliber

cc—cubic centimeter

LCAC—landing craft air cushion

VIP—very important person



# APPENDIX F

## IMAGERY INTELLIGENCE REPORT FORMATS

### Reconnaissance Exploitation Report Example

PAGE 1 EXREP 15TH 102 CLASSIFICATION: \_\_\_\_\_ 831122 03346

UNCLASSIFIED EXERCISE NEVERLAND

MSG ID/RECCEXREP/15TH/NO2222/3456

EFDT: 230442Z DEC 90

NARR: REF ITMOOS, LG ACTY NOTED THROUGHOUT TGT AREA

ITEM P6

ITM: 001 0380EX0000 CTY: MS 363219M1263214E

A. 52SDR46118324

B. 230422ZDEC90

C. CAT: 06 Command Post.

1. Mobile command post.
2. Static, camouflaged.
3. 10 T-62 tanks, 3 M-1979 self-propelled guns, 5 UAZ69As, 5 LG tents, 2 spoonrests, 50 PERS (count approx).
4. No defense noted.
5. Terrain is flat with little vegetation, approx 13 km SE of post, a AAA site was noted.

D. NO REPORT TO FOLLOW

1. ACFT was fired upon AAA site.
2. 0081X.
3. Yes.

PAGE 1 EXREP 15TH 102 CLASSIFICATION: \_\_\_\_\_ 831122 03346

**Initial Photographic Interpretation Report and  
Supplemental Photographic Interpretation Report Format**

PRECEDENCE

FROM: IIC

TO: REQUESTOR

INFO:

REF: (a) As applicable.

(A) CLASSIFICATION

(B) SECTION 01 OF 01 SECTION

(C) IPIR: FIRST IIP SER: UVO157 PRJ: RD MSN: Z198A DTZ: 75022W

(D) IMAGE QUALITY RANGE WAS GOOD TO EXCELLENT. EIGHT OF TWELVE OF THE COLLECTION REQUIREMENTS WERE SATISFIED.

---

(E) PART I. MISSION HIGHLIGHTS

(F) NO EVIDENCE OF SURFACE-TO-SURFACE MISSILES OR RELATED ACTIVITY WAS NOTED. VEHICULAR AND TROOP MOVEMENT ACTIVITY IS VERY LIGHT. NO ANTI-AIR ACTIVITY OR REACTIONS TO THE RECONNAISSANCE PLATFORM WERE OBSERVED.

---

(G) PART II. SIGNIFICANT RESULTS

(H) 1. PERISHABLE ITEMS

(I) ITMOOA: 0213-00000 CAT: 80000 AIRCRAFT IN FLIGHT

(J) REQ: CTY: LA211929N1061934E UTM: MRG:

(K) STA: TRM AI NRG:

(L) AOB:

0001 CONF PA-23 INFLIGHT HDG NORTHEAST

(M) IMR: PAN FRM: 1011, 1012 URG

AID: E AO CL BB FRM TOT: 1035Z

(H) 2. NEW ITEMS

(I) ITM002: 0213UV0006 CAT: 87200 PURTEE SAM SITE

(J) REQ: CTY: LA210815N1055619E UTM: MRG:

(K) STA: UCO

(L) DES: SA-O SITE IS BEING ESTABLISHED APROX ONE-HALF KM FROM THE RED RIVER. SITE CONSISTS OF SIX RVTD PSNS IN A STAR FORMATION. FULL DESCRIPTION NOT YET POSSIBLE. NO EQUIPMENT EXCEPT FOR CONSTRUCTION AND GROUND FORCE RELATED WAS IN THE AREA.

GFW:

0008 CONF DUMP TRUCK

0001 CONF ZAZ-7 CRANE

0001 PROB A-2 TRACTOR URG:

(O) IMR PAN FRM: 976-980 TOT: 1039Z

AID: G AO SC SH BB

(H) 3. CHANGE AND OOB ITEMS

(I) ITM 0002: 0213-02351 CAT: 09100 WATERTON BARRACKS AREA

(J) REQ: 4A02316 CTY: LA221600N1053012E UTM: MTG:

(K) STA: OPR AI NAC DQ B1236 750102 NRG: NDA04/0014/5

(L) RMK: PREVIOUSLY REPORTED U/I ARMORED EQUIPMENT HAVE NOW BEEN IDENTIFIED AS SWG-99 TANKS.

GFW: AREA A-REGT A

0103 CONF SWG-99 TANK

0092 CONF DTR-12 TRUCK

0002 CONF MT-3 CRANE

GFW: AREA B-REGT AREA NAC DQ B1236 750102

GFW: AREA C-REGT AREA NAC UP 298A 741209

GFW: AREA C-AAA BN NAC UP 208A 741209

(M) IMR: PAN FRM: 500.490-516 URG: 234118

AID: G AO CL BB FRM: 135-138 TOT: 1025Z

IDC: 221615N1053045E MPR:

(N) EQM

---

(O) PART III. OTHER RESULTS

(P) Mission Requirements

(Q) Categorization of Target Entries. An introductory statement is written here categorizing a set of like items to increase readability. Defense Intelligence Agency Manual (DIAM) 57-5, *DOD Exploitation of Multisensor Imagery*, contains more detailed information on the structure of part III.

---

(R) PART IV. COLLECTION OBJECTIVES SATISFIED AND NOT SATISFIED

---

## Paragraph Instructions for Initial Photographic Interpretation Report and Supplemental Photographic Interpretation Report Format

The following are instructions for completing each paragraph of an IPIR and SUPIR.

*Note:* Information in parentheses is shown for explanation only. Line identification is not shown on an actual message. The IPIR/SUPIR/multimission imagery photo interpretation report (MIPIR) format has been revised to accommodate the growth of automated intelligence systems. However, as a user's guide to understanding the reports, the following definitions are provided.

Cable Line.

References.

(A) Self-explanatory.

(B) Self-explanatory.

(C) Report type identifies the following:

- Reporting organization.
- Report number: reports will be numbered sequentially by the producing unit. (A two-character alpha unit identifier followed by a four-digit sequential number.)
- Reconnaissance project identification: Two characters indicating the project of which this mission is part. This stands for mission independent.
- Mission number.
- Date/time zone.

(D) General Mission Statement. Free text reporting information applying to the entire mission, such as graphic reference, sensors, sensor on/off times and coordinates, overall image quality, overall image scale range, other general mission data, or any other information deemed useful. If the objectives of the mission and the requesting authority can be given (consider length and classification), these will be included. The general mission statement will be written as the interpreted mission and appropriate data will be reported.

(E) Part I. MISSION HIGHLIGHTS. Title for first major division of the report.

(F) Textual Data for Mission Highlights. Part I, Mission Highlights allow for a concise free text statement of the significant information derived from the mission. It may be used to highlight individual items reported elsewhere in the message and to summarize information relative to a category of targets. Mission highlights may also be utilized for summations of trends of individual categories, such as logistic studies or combat information of a significant nature.

(G) Part II. SIGNIFICANT RESULTS. Title for second major division of the report.

(H) Categories of Items That May be Reported.

1. Perishable Items. This section is for items of perishable intelligence value, including transitory targets.
2. New Items. This section is for items upon which the reporting organization has no previous image-derived data.
3. Change and OOB Items. This section is for items that reflect significant changes since the last available interpretation and targets for which OOB is required. For DOD combat reconnaissance programs, this section includes mission requirement objectives. A mission objective could also be reported under perishable items of damage assessment.
4. Bonus Items. This section includes significant changes to any known installation that is not a specified mission requirement objective.
5. Damage Assessment. This section is for the description of damage to targets from nonnuclear attacks. This section includes known strike objectives not damaged.

(I) Identification data:

- Item number.
- Basic encyclopedia (BE) number or imagery basic encyclopedia number.
- Functional classification code. See DIA Publication 5210.002-M, *Standard Coding Systems Functional Classification Handbook*.
- Installation name or description of object imaged.

(J) Other identification data:

- Requirement number.
- Country code.
- Geographic coordinates.
- Universal transverse mercator coordinates.
- Military district. Entered when applicable.

(K) Status/activity data:

- NEG. Negated (nonexistent). Target/installation does not exist at or near the coordinates given in the requirement.
- UCO. Under construction.
- COM. Complete. The target/installation appears to be externally complete. Appears capable of operating but operational status cannot be determined.

- UNK. Unknown. Status of the target cannot be determined.
- NOP. Not operational. Essential elements of a target/installation are observed not to be in operation; equipment essential to the operation of the installation is either missing or observed as not to be operational.
- OPR. Operational.
- OCC. Occupied.
- DEC. Deception.
- UNP. Unoccupied.
- ABN. Abandoned.
- RMV. Removed. Target/Installation has been razed, dismantled, or moved.
- TRN. Transitory. Fleeting targets or targets that appear to be only temporarily situated.
- DMG. Damaged. Target is damaged to some extent, but it may be restored to usable condition.
- DST. Destroyed. Target is so damaged that it cannot function as intended or be restored to usable condition.
- CNA. Coverage not available.

Exploitation Level:

- AI - IPIR
- AS - SUPIR
- MI - MIPIR

Significance. The significance code indicates the interpreter's assessment of the degree of change in the installation status, capability, or function since previous mission coverage. If a significance code is entered, the reference mission number and date will be entered. Codes are as follows:

- NEW. Newly detected activity.
- SIG. Significant change has occurred.
- UNK. Significance of change is not known or change, if any, cannot be determined.
- NAC. No apparent change.

Reference Graphic. When a national basic reference graphic exists, the number may be required for specific programs. In all other cases, it will be left blank.

(L) Additional Interpretation Data. Additional photo interpretation data will be organized under one of the following codes:

- DES. Physical description. A DES will be accomplished when an installation is covered for the first time, a basic description of the installation has not been previously written, the installation reflects a significant physical change, or first reporting an installation as abandoned or destroyed.
- RMK. Remarks. This prefix will be used when providing less than a complete description of a known target/additional explanatory comments relating to status/activity. Only a DES or RMK

will be used for each entry, not both. If NAC is entered on the status line, a DES will not be used. The remark will include the project code and mission numbers of the coverage used to prepare the report in those cases where more than one mission is used. For MIPIR, the actual OOB count will be taken from a representative mission flown during the reporting period.

#### Order of Battle Designations:

- MIS. Missile and missile related equipment.
- AOB. Air OOB.
- NVL. Naval and merchant vessels.
- GFW. Ground force weapons and equipment.
- ELC. Electronic OOB.
- AAA. Antiaircraft OOB.
- DMY. Dummy.
- OBJ. Associated objects. Information relative to objects and equipment not reported under OOB entries.

Area Delineation. Refers to area delineation of the national basic reference graphic or other descriptive location data. When reference graphics are not available, location reporting is permitted (e.g., assembly area). Multicoverage dates may be included following each location entry or as unique entries.

(M) Imagery Reference Data (IMR). A minimum of one IMR line is required; however, more lines may be required to indicate different coverage. For MIPIR, only those missions that contributed to a specific degree are entered on the IMR line. Initial information in the IMR line may include date of coverage, project code, mission number, and camera station. The following coded items may then be used:

- IMR. Frame number.
- SLR. Side-looking radar.
- INF. Thermal.
- URG. Universal reference grid. Six position URG coordinates.
- AID. Additional imagery data. AID is used to provide interpretability data. Interpretability codes are as follows:
  - E-Excellent.
  - G-Good.
  - F-Fair.
  - P-Poor.

#### Extent of Coverage and Mode:

- A-Complete coverage/stereo.
- B-Complete coverage/partial stereo.



- C-Complete coverage/mono.
- D-Partial coverage/stereo.
- E-Partial coverage/partial stereo.
- F-Partial coverage/mono.

Type of Coverage:

- O-Oblique.
- V-Vertical.

Weather Conditions:

- CL-Clear.
- SC-Scattered.
- HC-Heavy Clouds.
- HA-Haze.

Other Conditions:

- SN-Snow.
- SH-Shadow.
- OL-Degrading obliquity.
- SD-Semidarkness.
- BL-Blurred image.
- TR-Terrain masking.
- HD-Heavy smoke/dust.

Type of Film:

- B-Black and white.
- C-Natural color.
- G-Green record.
- I-Color rear infrared.
- R-Red record.
- T-Thermal.
- S-Radar.
- N-Nonstandard.

*Note:* For stereo or partial stereo, two letters will be used, one for the first frame and one for the second frame; e.g., BB, black and white on both frames.

- FRM. Additional frame reference for a given target.
- TOT. Time on target.
- IDC. Imagery derived coordinates, derived from comparing imagery with a map or chart.
- MPR. Map reference.
- PPC. Precision photo derived coordinates.

(O) Part III. OTHER RESULTS. Third major division of the report, as indicated by the sample; part III may be omitted.

(P) Mission Requirements. Provides for reporting items/targets not properly placed in part II.

(Q) Categorization of Target Entries. The format in part IV will contain collection objectives satisfied and not satisfied, plus a textual statement indicating any reasons for nonsatisfaction. Items contained in part IV can be understood from the codes listed earlier.

(R) Part IV. COLLECTION OBJECTIVES SATISFIED AND NOT SATISFIED. Part IV of the format will contain collection objectives satisfied and not satisfied, plus a textual statement indicating any reasons for nonsatisfaction. Items contained in part IV can be understood from the codes listed earlier.

# APPENDIX G

## EXAMPLE OF A MARINE UNMANNED AERIAL VEHICLE SQUADRON EQUIPMENT AND PERFORMANCE CHARACTERISTICS

---

### SHADOW UNMANNED AIRCRAFT SYSTEM

The Shadow UAS consists of the following:

- Shadow UAS aircraft (see fig. G-1 on page G-2).
- Ground control station (see fig. G-2 on page G-2). The ground control station provides control of air vehicle and payload out to 125 km.
- Pneumatic launcher (see fig. G-3 on page G-3).
- Portable ground control station.
- Ground data terminal tracking system consists of track control unit on a pedestal antenna assembly and an interrogator unit. This system provides communication between aircraft and ground control station.
- Tactical automatic landing system. The airborne system consists of transponder onboard aircraft. This system provides for automatic landing guidance and control of the aircraft.
- Portable ground data terminal.
- Remote video terminal.
- Modular mission payload.



**Figure G-1. Shadow Aircraft with Unmanned Aircraft System.**

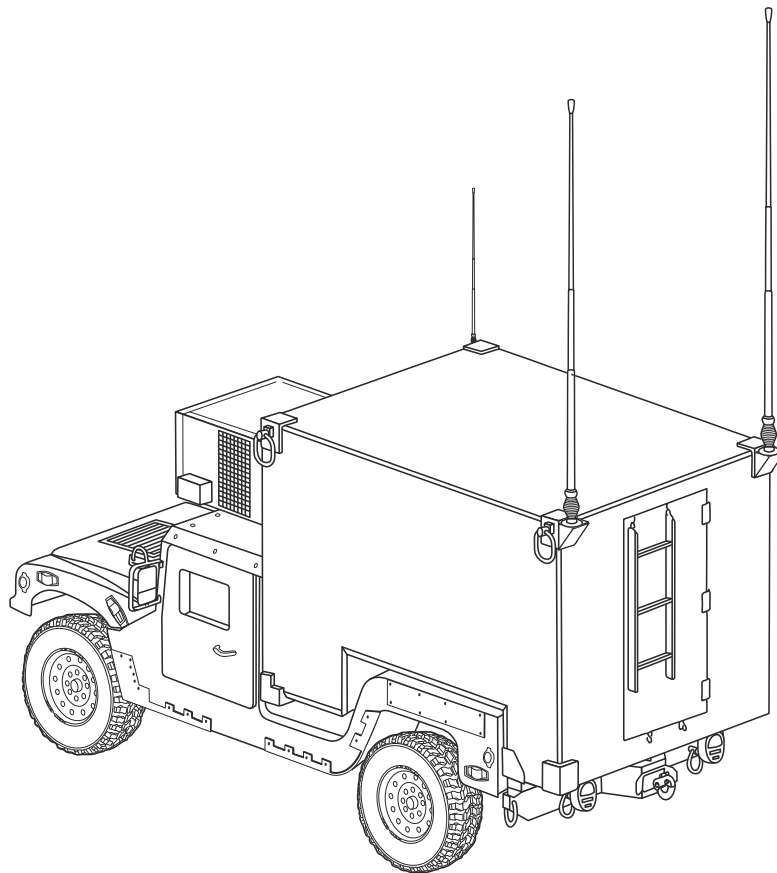

**Figure G-2. Shadow Ground Control Station.**

---

## SHADOW UNMANNED AIRCRAFT SYSTEM CHARACTERISTICS



**Figure G-3. Shadow Unmanned Aircraft System on Pneumatic Launcher.**

**Table G-1. Shadow Unmanned Aircraft System Characteristics.**

<b>Engine Limitations</b>	
Maximum Operational	8,000 RPM for 2 minutes
Maximum Continuous Climb	7,800 RPM
Maximum Continuous Cruise	7,500 RPM
Minimum In-Flight	3,800 RPM
Maximum Static Full Throttle	7,200 RPM
Minimum Static Full Throttle	6,300 RPM
Rotor Temperature Operating Range	64°C–175°C
Maximum Continuous Cylinder Head Temperature	259°C for 2 minutes in a climb
Maximum Transient Cylinder Head Temperature	249°C
Minimum Cylinder Head Temperature	80°C
Static Idle RPM (Payload and IFF On)	3,600 RPM–3,840 RPM
<b>Bus Voltage</b>	
Bus Voltage (with engine operating)	26V–30 volts
Battery Fail	less than 19 volts
<b>Airspeed Limitations</b>	
TALS Automatic Abort High	78 kts for 2 seconds
TALS Automatic Abort Low	52 kts for 2 seconds
Low Airspeed Alert	55 kts
Turbulence (Rough Air)	70 kts
Maximum Airspeed Limits	60 kts–110 kts
<b>Altitude Envelope</b>	
Minimum Safe FTS Deploy	1,000 ft AGL
Minimum Altitude	Electric line of sight
Service Ceiling	15,000 MSL
Maximum Launch Altitude	9,000 density altitude
<b>Wind Limitations (Takeoff and Landings)</b>	
Maximum Headwind/Crosswind	20 kts gusting 25 kts
Maximum Tailwind For Launch	IAW maximum tailwind for launch and minimum precharge pressure tables
Maximum Tailwind Upon Selecting "Land AV"	0 kts
Maximum Tailwind During TALS Auto Recovery	5 kts

Legend:

AV–air vehicle

AGL–above ground level

°C–degrees Celsius

FTS–flight termination system

IAW–in accordance with

IFF–identification, friend or foe

kts–knots

MSL–modified surf limit

RPM–revolutions per minute

TALS–tactical automated landing system

# APPENDIX H

## REQUEST FORMATS FOR

### AERIAL IMAGERY COLLECTION MISSIONS

#### Joint Tactical Air Reconnaissance/Surveillance Request Format Example

PRECEDENCE

FROM:

TO:

INFO:

CLASSIFICATION

SUBJ: JTAR/S REQ

L. REQUEST NO. \_\_\_ PREPLANNED A. PRIORITY \_\_\_ B. PRECEDENCE \_\_\_  
\_\_\_ IMMEDIATE C. PRIORITY \_\_\_

M. DATE/TIME FACTORS

1. DATE MISSION DESIRED
2. TOT (IF REQUIRED)
3. LTIOV
4. PRIOR COVERAGE ACCEPTABLE (DAYS PRIOR)

N. TYPE RECON REQUESTED

1. TYPE MISSION

A. VISUAL

B. IMAGERY

C. ELECTRONIC

2. TYPE COVERAGE
  - A. PINPOINT
  - B. STRIP/LINES OF COMMUNICATION
  - C. ROUTE RECONNAISSANCE
  - D. AREA SEARCH
  - E. AREA COVERAGE
  - F. AFLOAT
3. \*SENSOR TYPE
  - A. OPTICAL
  - B. INFRARED
  - C. SLR
  - D. ELECTRONIC
  - E. LASER
  - F. OTHER
4. \*TYPE PHOTO
  - A. VERTICAL
  - B. OBLIQUE
  - C. PANORAMIC
5. \*TYPE FILM
  - A. BLACK AND WHITE
  - B. COLOR
  - C. CAMOUFLAGE DETECTING
6. STEREO PHOTO
  - A. NOT REQUIRED



B. REQUIRED

O. MAP REFERENCE

TYPE AND SCALE \_\_\_\_\_

SERIES \_\_\_\_\_

SHEET \_\_\_\_\_

EDITION \_\_\_\_\_

DATE \_\_\_\_\_

P. TARGET COORDINATES

1. UTM
2. LAT/LONG
3. OTHER (SPECIFY)

Q. TARGET CATEGORY/PRIORITY INTELLIGENCE REQUIREMENT(S) (SEE DETAILED INSTRUCTION)

1. AIRFIELD
2. ARMOR/ARTILLERY/TROOPS/VEHICLE
3. BRIDGE
4. DEF POS/STRONG PT [primary target]/GUN
5. ELECTRONIC SITE
6. HARBOR SITE
7. INDUSTRIAL
8. LOC
9. MIL. INST/STORAGE AREA
10. MISSILE SITE
11. POWER PROD. FACILITY

12. RAILROAD YARD

13. SHIPS

14. OTHER (SPECIFY)

R. REPORTS

1. IN-FLIGHT REPORT (CS/FREQ)\_\_\_\_\_ VALID FM\_\_\_\_\_ Z TO\_\_\_\_\_ Z  
(CS/FREQ)\_\_\_\_\_ VALID FM\_\_\_\_\_ Z TO\_\_\_\_\_ Z

2. MISSION REPORT

3. RECEXREP

4. IPIR

5. SUPIR

S. IMAGERY PRODUCTS (IF REQUIRED)

1. TYPE

2. QUANTITY

3. ADDITIONAL INFORMATION

T. DELIVERY ADDRESS

1. UNIT\_\_\_\_\_

2. AIR DROP (IF REQ): COORDS:\_\_\_\_\_

CALL SIGN/FREQ\_\_\_\_\_

RUN HEADING (MAG) (OPTIONAL)\_\_\_\_\_

U. REMARKS/SPECIAL INSTRUCTIONS

1. TARGET AREA CONTROL (CALL SIGN/FREQ)\_\_\_\_\_

2. OTHER (SPECIFY)\_\_\_\_\_

*Note:* Designate minimum mandatory items for immediate requests. An \* indicates use as applicable or when known. The format provided has been published as STANAG 3277 and has been approved by NATO as a

standard format for aerial requests. The letters A through K have special significance for certain organizations and are purposely omitted. When submitting message JTAR/S, the paragraph headings are not required, but the alpha-numeric paragraphs will not be changed. Instructions for completing a JTAR/S follow in this appendix.

### Paragraph Instructions

The following are instructions for paragraphs L through U of a JTAR/S request.

L. REQUEST NUMBER: As directed.

A&C Priority: Use numerical designation below to define the tactical urgency for preplanned and immediate requests.

PRIORITY: It is the responsibility of the requestor to establish the priority.

Priority No.	Definition:
1	Takes precedence over all other requests except previously assigned Priority 1 requests. The results of these requests are of paramount importance to the immediate battle situation or objective.
2	The results of these requirements are in support of the general battle situation and will be accomplished as soon as possible after Priority 1 requests. These are requested to gain current battle information.
3	The results of these requests update the intelligence database but do not affect the immediate battle situation.
4	The results of these requests are of a routine nature and will be fulfilled when the reconnaissance effort permits.

#### M. DATE/TIME FACTORS

1. Self-explanatory.
2. State the TOT only when required and justify U2.
3. Indicate the LTIOV, if it is a factor. Deliver prior to this date/time.
4. Self-explanatory.

#### N. TYPE RECONNAISSANCE REQUESTED

1. Type of Mission (self-explanatory).
2. Type of Coverage.
  - a. Pinpoint (self-explanatory).
  - b. Strip/LOCs (search continuous photography of a route of LOC).
  - c. Route Reconnaissance (visual reconnaissance of a route of LOC with photo of targets of military significance).

- d. Area Search (visual search of a specified area with photos of targets of military significance).
- e. Area Coverage (photographic coverage of a specified area).
- f. Afloat (reconnaissance of vessels afloat).

Numbers 3, 4, and 5 are self-explanatory. These lines should be left blank unless it is fully understood what the selected sensor, photo, and film can accomplish.

O. MAP REFERENCE (self-explanatory).

P. TARGET COORDINATES. Provide reference system used and indicate actual coordinates.

Q. TARGET CATEGORY/PRIORITY INTELLIGENCE REQUIREMENT(S). Provide the appropriate category and indicate the desired PIR by selecting the number(s) from the target list category below.

CATEGORY 1—AIRFIELD

- A. Activity: number, type, and location of aircraft.
- B. Runways: number, orientation, and surface type.
- C. Taxiway and parking areas: location and shape.
- D. POL: number, size, and location.
- E. Ammunition storage areas: number and location.
- F. Hangars: number, size, and type of construction.
- G. Electronic facilities: number, type, and location.
- H. Defenses: number, type, and location.
- I. Other: (specify).

CATEGORY 2—ARMOR/ARTILLERY/TROOPS/VEHICLES

- A. Type: infantry, armor, engineering, artillery, etc.
- B. Number and type of vehicles.
- C. Number and type of armor.
- D. Number and type of artillery.

E. Activity: direction of movement, dug in, etc.

F. Terrain: description.

G. Other: (specify).

#### CATEGORY 3—BRIDGE

A. Purpose: flood, rail, over road, etc.

B. Type: railroad, vehicular, agricultural, etc.

C. Construction: wood, steel, concrete, etc.

D. Construction: piers, abutments, approaches, stringers, beam, truss, etc.

E. Number of spans.

F. Length and width (height if significant).

G. Number of lanes/tracks.

H. Bypass in vicinity of bridge.

I. Activity.

J. Other: (specify).

#### CATEGORY 4—DEFENSIVE POSITIONS/STRONG POINTS/GUNS

A. Type and size of position or fortification.

B. Type weapons: number.

C. Fire control system.

D. Supporting positions.

E. Transportation access.

F. Routes of ingress and egress.

G. Nature of surrounding terrain and foliage barriers.

H. Activity.

I. Other: (specify).

CATEGORY 5—ELECTRONIC SITE

- A. Type of site: microwave relay, EW, etc.
- B. Antennas: number and type.
- C. Mobile or permanent.
- D. Primary buildings and support equipment.
- E. Activity.
- F. Security measures.
- G. Size of area.
- H. Other: (specify).

CATEGORY 6—HARBOR/PORT FACILITIES

- A. Type port: maritime or inland waterway.
- B. Activity.
- C. Berthing and cargo handling facilities.
- D. POL facilities: type, number, and locations.
- E. Storage facilities.
- F. Shipbuilding and repair facilities.
- G. Transportation.
- H. Defenses.
- I. Other: (specify).

CATEGORY 7—INDUSTRIAL SITE

- A. Type of industry.
- B. Size of area.
- C. Buildings: number, size, and construction.
- D. Open storage: quantity by type.
- E. Activity.

F. Transportation facilities.

G. Source of power.

H. Defenses.

I. Other: (specify).

CATEGORY 8—LINE OF COMMUNICATIONS

A. Type: road, rail, canal, etc.

B. Description of the route.

C. Chokepoints.

D. Significant activity.

E. Significant static targets.

F. Other: (specify).

CATEGORY 9—MILITARY INSTALLATIONS/STORAGE AREAS

A. Function: assembly, administration, barracks, depot, etc.

B. Activity: number of vehicles and/or personnel.

C. Size of the area.

D. Number of buildings: predominant construction only.

E. Storage: type and location.

F. Transportation.

G. Defenses.

H. Other: (specify).

CATEGORY 10—MISSILE SITE

A. Type.

B. Launch site: mobile/fixed, number of pads, etc.

C. Number and orientation of launchers/number loaded.

D. Control center: location and construction.



- E. Number, type, and location antenna(s).
- F. Auxiliary equipment.
- G. Activity.
- H. Defenses.
- I. Other: (specify).

CATEGORY 11—POWER PRODUCTION FACILITY

- A. Type: nuclear, coal, oil, hydroelectric, etc.
- B. Size and construction.
- C. Boiler/generators: number and location.
- D. Transformer yard: size and location.
- E. Cooling towers: number and location.
- F. Penstock/turbine outlet (hydroelectric).
- G. Activity.
- H. Defenses.
- I. Other: (specify).

CATEGORY 12—RAILROAD YARD

- A. Type: classification, repair, other.
- B. Length and width: chokepoint to chokepoint.
- C. Number of tracks.
- D. Facilities: repair shops, roundhouses, other.
- E. Rolling stock.
- F. Defenses.
- G. Other: (specify).

CATEGORY 13—SHIPS

- A. Class/type/number.
- B. Heading/movement.
- C. Nationality.
- D. Identification.
- E. Cargo.
- F. Activity.
- G. Other: (specify).

CATEGORY 14—OTHER

Narrative report is rendered under this heading in sufficient detail to ensure that the request or purpose of the mission is satisfied.

R. REPORTS.

- 1. In-flight report to friendly units.
- 2. Mission report of the results and significant sightings gathered.
- 3. Reconnaissance exploitation report, a brief, concise, high priority report on time-sensitive targets of significant tactical importance of a perishable nature.
- 4. IPIR that contains intelligence on mission objectives and additional significant intelligence.
- 5. SUPIR that provides detailed intelligence acquired through a comprehensive study of imagery.

S. IMAGERY PRODUCTS (specify type and quantity of imagery products required. Only mission essential imagery products should be requested).

T. DELIVERY ADDRESS.

- 1. Unit (delivery address for mission essential imagery products).
- 2. Air drop (coordinates, call sign, frequency, and run-in heading for aerial delivery of imagery products).

U. REMARKS/SPECIAL INSTRUCTIONS.

1. Target area control (indicate, when applicable, the call sign and radio frequency of the control element. Control of the mission will require close coordination with ground forces).
2. Other (self-explanatory, use this space to specify scale if required and to request specific TOT).

**Immediate Joint Tactical Air Reconnaissance/Surveillance Request Format Sample**

Source: Joint Tactical Air Strike Request Format (Voice Template)

1.UNIT CALLED THIS IS \_\_\_\_\_ REQUEST # \_\_\_\_\_

2.IMMEDIATE \_\_\_\_\_ C PRIORITY \_\_\_\_\_

3.TARGET IS/NUMBER OF

A. PERS IN OPEN \_\_\_\_\_ / \_\_\_\_\_

B. PERS DUG IN \_\_\_\_\_ / \_\_\_\_\_

C. WPNS/MG/RR/AT \_\_\_\_\_ / \_\_\_\_\_

D. MORTARS/ARTILLERY \_\_\_\_\_ / \_\_\_\_\_

E. AAA, ADA \_\_\_\_\_ / \_\_\_\_\_

F. RKTS, MISSILE \_\_\_\_\_ / \_\_\_\_\_

G. ARMOR \_\_\_\_\_ / \_\_\_\_\_

H. VEHICLES \_\_\_\_\_ / \_\_\_\_\_

I. BLDGS \_\_\_\_\_ / \_\_\_\_\_

J. BRIDGES \_\_\_\_\_ / \_\_\_\_\_

K. PILLBOX BNKRS \_\_\_\_\_ / \_\_\_\_\_

L. SUPPLIES, EQUIP \_\_\_\_\_ / \_\_\_\_\_

M. CNTR (CP, COM) \_\_\_\_\_ / \_\_\_\_\_

N. AREA \_\_\_\_\_ / \_\_\_\_\_

O. ROUTE \_\_\_\_\_/\_\_\_\_\_

P. MOVING NESW \_\_\_\_\_/\_\_\_\_\_

Q. REMARKS \_\_\_\_\_

4.TARGET LOCATION/ROUTE/AREA IS

A. \_\_\_\_\_ (COORDINATES)

B. \_\_\_\_\_ (COORDINATES)

C. \_\_\_\_\_ (COORDINATES)

D. \_\_\_\_\_ (COORDINATES)

E. TARGET ELEVATION \_\_\_\_\_

F. SHEET # \_\_\_\_\_

G. SERIES \_\_\_\_\_

H. CHART # \_\_\_\_\_

5.TARGET TIME/DATE

A. ASAP \_\_\_\_\_

B. NLT \_\_\_\_\_

C. AT \_\_\_\_\_

D. TO \_\_\_\_\_

6.DESIRED RESULTS/MISSION/PIR<sub>s</sub>

(FREE TEXT \_\_\_\_\_)

7.REMARKS

(FREE TEXT \_\_\_\_\_)

# APPENDIX I

## TARGET FOLDERS

A target folder contains intelligence that provides the location and components of a target or target complex and indicates its vulnerabilities and relative importance. It also contains related materials prepared for planning and executing actions against a specific target. A major prerequisite for starting a target folder is the relative degree of permanence of the potential target. In addition, local command SOPs will provide guidance as to targets needed to have folders maintained.

---

### IMAGERY ANALYSIS

Imagery intelligence is often the definitive information source of intelligence support to targeting. Imagery intelligence input is reliable, accurate, and current and often forms the basis for targeting decisions. Imagery analysis is a vital component in the tactical and strategic targeting process. It is often the imagery analyst, during the analysis of imagery, who—

- Discovers potential targets and draws them to the attention of the command (CMD section).
- Conducts the target study that is an analysis of the proposed target from imagery and other pertinent sources.
- Takes the information provided by the target analysis and puts it into a target folder format.

---

### TARGET ANALYSIS

The ISC is responsible to the AC/S G-2 for imagery intelligence efforts supporting the MEF's targeting process. Before a possible target can be selected for possible engagement, it must be developed such that its composition, strengths, and vulnerabilities are well known.

The analysis of a target requires the collection and evaluation of many items of information. The target folder is an instrument for the compilation and organization of relevant data produced by the target analysis. Decisions by the force fires coordinator and fire support coordinators regarding whether to attack a proposed target and which weapon system to select are critically influenced by the information in the target folder.

Once a possible target has been identified and approved for inclusion in the target intelligence data base, the imagery analyst and all-source intelligence analysts will prepare a target folder.

This analysis presents all available pertinent information on the proposed target from the following sources:

- *Reference materials.* Perform a thorough check of all available intelligence reference materials, such as interrogation, counterintelligence, ground reconnaissance, and SIGINT reports. All may be useful.
- *GEOINT.* Ensure current maps (latest editions) and other GEOINT materials of the target area are available.
- *Mission coverage.* Examine comparative coverage of the target area from past and ongoing imagery collections missions. If the latest available coverage is old, incomplete, poor quality, or the installation is under construction or renovation, then new collection missions may be required.

### Specifications

A target folder is a reference file on permanent potential targets in the AO and AOI that has been created and maintained by the unit. It contains the results of the target study (analysis) and any updates or collateral intelligence. Target folders—

- May be used as a pre-mission briefing aid for aircrews to orient them on target location, recognition, defenses, and obstacles. Imagery analysts may use target folders strictly as reference files on important intelligence targets within the unit's AO. Such folders can be compiled to show an installation's development or an enemy unit's organization.
- Have common characteristics and contain a minimum of important elements.
- Are for permanent targets. A permanent C2 node, troop training area, warehouse area, port facility, or fixed missile site is a good potential target for target folders. Temporary targets, such as troops in the field, supply dumps, and ships in port or truck convoys, are usually not proper subjects for target folders.
- Are current. Because the information within a target folder may be used for target planning, it must be kept current. The target folder must be updated to reflect changes in defenses, physical characteristics, unit reorganization, important equipment, and so on.
- Are concise. Target folders are compact; only intelligence and other information pertinent to the commander's PIRs or intelligence requirements are included.
- Are accurate. Intelligence and other information within a target folder must be accurate to allow realistic targeting plans to be made. Answers to intelligence requirements must be specific to provide maximum value. For example, explicitly describe enemy defenses, target dimensions, shape, construction, use, and capacities.

*Note:* Target folders should be reviewed periodically—or with each new imagery mission (intelligence priorities, resources, and time permitting)—and their contents should be checked against new information or intelligence requirements.

### Format and Components

Enclosure F of CJCSI 3370.01, *Target Development Standards*, provides standards for developing electronic target folders (ETFs), hard copy target folders, and target materials.

Marine Corps imagery analysts will adhere to these guidelines and, within technological limitations, provide a product tailored to meet all supported commanders' target intelligence requirements. Although the contents of a target folder may vary slightly according to unit SOP, they will be in accordance with the Military Targeting Intelligence Committee guidelines and contain, at minimum, the following components:

- Heading.
- Target summary.
- Supporting materials.
- Weaponeering support.
- Assessment.
- Associated/collocated targets.
- Objectives and guidance.
- Folder notes/other related information.

Electronic target folders may be expanded to meet specific MAGTF or unit requirements. Additional information, such as supplemental graphics, vector (shapefile) overlays, capability specific supporting materials, three dimensional graphics, and other analytical or source documentation, may be entered into the ETF. The structure of ETFs will be standard across all target types and is intended to support use by all CCMDs, Services, CSAs, and allied producers in a joint/combined environment. Enclosure F of CJCSI 3370.01 provides details on ETF structure and content.

**Heading.** The heading contains the general identification details for each target entity and will include the following information:

- Classification and release (self-explanatory).
- Entity identifier (EID). (Use the EID, such as the BE number or communications transmission identifier, for the entity from the modernized integrated database [MIDB], when available. If an MIDB EID is not available, the target analyst must coordinate with the appropriate responsible analytic center to obtain a suitable unique EID.)
- Name. (Use the entity [i.e., facility] name as it appears in MIDB. If no record is available, the target analyst must liaise with the appropriate responsible analytic center to develop a suitable name using an approved naming convention.)
- Category and function code:
  - Installation/facility. If available, use the category code from the MIDB or consult DIA Publication 5210.002-M, which contains the complete numbering breakdown.
  - Other entity types (See appendix B to enclosure E of CJCSI 3370.01.).
- O-suffix (facilities only) (as assigned by MIDB).
- Location:
  - Latitude/longitude.
  - Military grid reference system.
  - Datum.

- Country code. (Use the country code from MIDB.)
- Original production date/last update. (Note the year, month, and day the ETF was produced or last updated in a nine-digit format, e.g., YYYYMMDD.)

**Target Summary.** The target summary has the following characteristics:

- *Significance statement (basic).* Use the data from the MIDB to state the significance of the target. For example, “Destruction of this target will deny the enemy 100,000 barrels of POL.”
- *Target description (intermediate).* Producers will identify the target type and provide a comprehensive description of the target, including any EEs and any associated critical elements.
- *Functional characterization (intermediate).* This statement elaborates on the function of the target.
- *Expectation statement (intermediate).* When feasible, use data from MIDB.
- *Collateral concerns (intermediate).* For facility/installation target types, if the nearest collateral object falls within the collateral damage estimation (CDE) level 1 collateral effects radius, it must be functionally characterized and identified by distance and direction from the target. The CDE is documented in the weaponeering section of the ETF.

**Supporting Materials.** At minimum, all ETFs produced on installations or facilities will include both an installation outline graphic and a facility (O-suffix) outline graphic. All details and supporting examples of imagery required from ETFs are detailed in appendix D, enclosure F of CJCSI 3370.01.

**Weaponeering Support.** Weaponeering support will include the following information:

- *Aimpoint (advanced).* An aimpoint is a weapon placement term that applies to a variety of capabilities (e.g., a joint desired point of impact is a type of aimpoint).
- *Unique target characteristics.* The EFT should provide a detailed description of unique target/element/aimpoint or joint desired point of impact characteristics that would support weaponeering for all weapons/weapon types.
- *Suggested weaponeering solutions (advanced).* Force fires center or FSCC personnel will complete in this section.
- *Collateral damage estimate.* The CDE will be accomplished in accordance with CJCSI 3160.01A, *No-Strike and the Collateral Damage Estimation Methodology*. The force fires center or FSCC personnel will complete in this section.

**Assessment.** At minimum, the assessment section will include areas for physical damage/change and functional damage assessments.

*Physical Damage/Change Assessment.* Physical damage assessment estimates the quantitative extent of physical damage (through munitions blast, fragmentation, and/or fire damage effects) to a target resulting from the application of military force. (JP 1-02) Change assessment is the identification and assessment of measurable change/damage to the target resulting from nonlethal methods or weapons.



*Functional Damage Assessment.* Functional damage assessment estimates the effect of military force to degrade or destroy the functional or operational capability of the target to perform its intended mission and on the level of success in achieving operational objectives established against the target. (JP 1-02)

*Munitions Effectiveness Assessment.* The munitions effectiveness assessment is the assessment of the military force applied in terms of the weapon system and munitions effectiveness to determine and recommend any required changes to the methodology, tactics, weapon system, munitions, fusing, and/or weapon delivery parameters to increase force effectiveness. (JP 1-02)

*Reattack Recommendation.* The reattack recommendation is an assessment that is derived from the results of the BDA and munitions effectiveness assessment, providing the commander systematic advice on reattack of targets and further target selection to achieve objectives. The reattack recommendation is a combined operations and intelligence recommendation.

***Associated/Collocated.*** The associated/collocated section provides a textual list of entities collocated to the primary installation or facility that the ETF was produced to support. At minimum, this list should provide a name, BE number, category code, O-suffix, and coordinates for each entity. These entities could include, but are not limited to, the following:

- Units.
- Equipment.
- Facilities.
- Individuals/personnel.
- Groups/organizations.
- Resources.

***Objectives and Guidance.*** The objectives and guidance section should include any associated strategic, operational, or tactical objectives or tasks related to the target on which the ETF was produced. This section should also include target damage and change objectives for the target.

***Related Information.*** The related information section is an open section for additional information or intelligence that targeteers assess as important to complete or augment the ETF.

---

# APPENDIX J

## NATIONAL IMAGERY

### TRANSMISSION FORMAT COMPRESSION

---

#### COMPRESSION BASICS

Compression is a process used to decrease imagery file sizes so that usable images can be transmitted as quickly as possible. The national imagery transmission format (NITF) uses Huffman coding which is statistically based and produces a single code for each symbol. Coding varies the length of the symbol in proportion to its information content. Symbols with a low probability of appearance are represented with a code consisting of many bits. Conversely, symbols with a high probability of appearance are represented with a code of fewer bits. Most compression applications are designed with predetermined quality settings. These settings are referred to as Q settings or Q levels. The lower the Q setting is, the greater the compression and, therefore, the greater potential loss of image quality.

#### **Joint Photographic Experts Group Image Compression**

Joint Photographic Experts Group (JPEG) image compression is one of the most popular and widely used compression algorithms. It was adapted for use in the NITF in the early 1990s. The complete specifications are contained in MIL-STD-188-198A, *Joint Photographic Experts Group (JPEG) Image Compression for the National Imagery Transmission Format Standard*. National Imagery Transmission Format JPEG's forward discrete cosine transform (FDCT) is a mathematical formula that divides the image into 8 by 8 minimum coding units or neighborhoods and then calculates the FDCT of each neighborhood. The quantizer *rounds off* or *smoothes* the FDCT coefficients according to the table specifications, and then the image is encoded.

For decompression, JPEG recovers the quantized FDCT coefficients from the compressed data stream, computes the inverse transform (using embedded tables), and displays the image. This description is simple; technical details are in the military standard. It is important, though, to understand how the various Q settings impact the quality of an image and the time available to transmit the compressed image.

The NITF JPEG provides several variants—discrete cosine transform (DCT) lossy (8- and 12-bit), downsample JPEG, and lossless.

**Discrete Cosine Transform Lossy.** In lossy compression some quality is sacrificed for increased compression ratios. When users employ DCT lossy, they can choose from five different Q levels (Q1–Q5). Level Q1 provides the greatest compression and, therefore, the greatest quality loss; while, Q5 provides the least compression and, consequently, the highest image quality (see table J-1).

**Table J-1. Discrete Cosine Transform Joint Photographic Experts Group Results Summary.**

Image	Original	Q1	Q2	Q3	Q4	Q5
Color	1:1 12:11	43:1 00:13	34:1 00:15	16:1 00:36	12.6:1 00:44	8.7:1 01:04
B&W	1:1 58:18	13.9:1 04:10	11.8:1 04:54	8:1 07:14	7:1 08:16	5.4:1 10:37
IR	1:1 08:32	43.6:1 00:11	33.9:1 00:15	25.9:1 00:19	14.6:1 00:35	5:1 01:35
SAR	1:1 13:21	9.9:1 01:20	7:1 01:53	6:1 02:10	4:1 03:03	2:1 06:11
UAS	1:1 17:05	25:1 00:39	17.9:1 00:57	17:1 00:59	8.7:1 01:57	2.5:1 06:41
Multi-spectral	1:1 21:50	17:1 01:16	10.5:1 02:04	6:1 03:36	3.8:1 05:41	2.1:1 10:23
Compression ration (n:1) Time to Transmit (mm:ss) @ 9600 bits per second						

Legend:  
 B&W–black and white  
 IR–intelligence requirement

**Downsample Joint Photographic Experts Group.** Downsample JPEG uses a compression technique that is essentially the same DCT JPEG compression applied to an image that has been downsampled. This means that the image size has been reduced by discarding image data. This process is illustrated in the figure J-1: the original 2,048 x 2,048 size is downsampled to 1,024 x 1,024 and then to 512 x 512. In this process the algorithm selectively throws away image data in both the X and Y axes to reach the next smaller file size until the smallest is reached. In the reverse process (upsampling), the image is restored to its original size.

**Lossless Joint Photographic Experts Group.** Lossless data compression techniques will generate exact duplicates of input data streams (or original images) once the data has been compressed. In other words, the data stream (or image) is decompressed back into its original form with no differences to be found. However, lossless compression rates are very small (approximately 2:1 or 2.5:1) and offer no significant reduction in image file sizes.

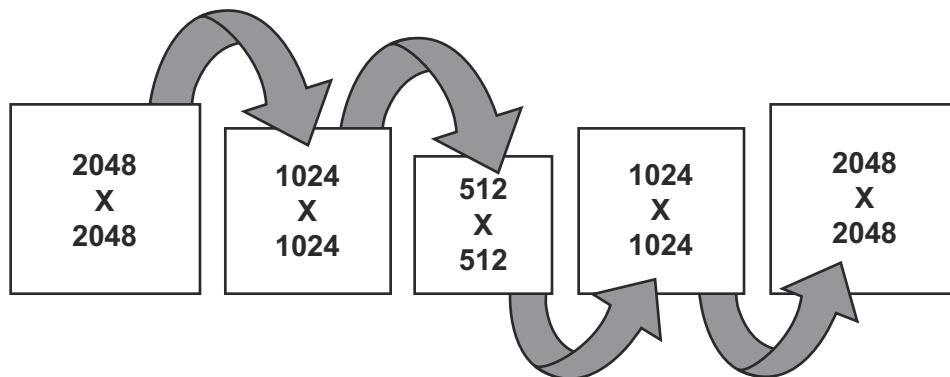

**Figure J-1. Downsample and Upsample Process.**

### Bi-Level Image Compression

The NITF handles textual information as well. Bi-level compression uses the same algorithm that is used in commercial facsimile devices. If users must learn more about this type of lossless compression or facsimile devices, MIL-STD-188-161, *Interoperability and Performance Standards for Digital Facsimile Equipment*, and MIL-STD-188-196, *Department of Defense Interface Standard: Bi-Level Image Compression for the National Imagery Transmission Format Standard*, contain relevant technical information. The NITF implementation of bi-level compression provides three different modes of operation: mode 1 (one-dimensional coding); mode 2 (two-dimensional coding with standard vertical resolution), and mode 3 (two-dimensional coding with higher vertical resolution) (see fig. J-2). It is not necessary to know the details of bi-level compression. Users only need to know that the fundamental concept of this coding algorithm is to detect run lengths of one of two colors (for example, black or white) in an image. These run lengths are then replaced with Huffman codes. Synchronization codes that indicate the beginning of an image, the end of a line, or similar information are embedded.

<b>Mode 1</b> <b>52:1</b> (.15 bits per pixel)	<b>Mode 2</b> <b>67:1</b> (.11 bits per pixel)	<b>Mode 3</b> <b>59:1</b> (.13 bits per pixel)
--	--	--

**Figure J-2. Bi-Level Image Compression Results.**

### Video Compression

Motion imagery (or video imagery) is defined as imaging sensor/systems that generate sequential or continuous streaming images at specified temporal rates (normally expressed as frames per second). This type of imagery includes EO (video and television), infrared, complex waveforms based on radar imaging, MTL, and acoustic waterfalls. It is not within the scope of this publication to address all of these technologies, but it is necessary to know of their existence and that the NGA has published *MISP version 6.4*. This profile summarizes the results of work accomplished by the DOD/IC/NSG Motion Imagery Standards Board. The profile identifies MPEG [Motion Picture Expert Group]-2 as the standard video compression format. Additionally H.264 shall be the standard for applications constrained by low bandwidth channels (typically less than 1 megabyte per second that may not be adequately supported by MPEG-2). The MISP also allows the use of H.264 for higher bandwidth applications.

### National Image Compression

The following are some of the items that are different in the national image compression arena:

- National compresses 8-, 11-, and 12-bit imagery data using both JPEG lossy and JPEG lossless compression (as well as other non-JPEG compression algorithms). The compressed data is transmitted in NITF format. Uncompressed national image data is stored in 2 bytes (11- and 12-bit data).
- For national systems, the term quality levels applies to the three different bit rates, plus lossless.
- In addition to image compression within national systems, there is a separate technique called pre-processing that is conducted to remap the pixel values in order to optimize the compression process. This requires the receiver to conduct a post-processing function after decompressing the image. Receivers of this data must understand the post-processing of this algorithm.

---

## COMPRESSION STANDARDS

The following current standards are related to the aforementioned compression types:

- MIL-STD 188-161\_.
- MIL-STD 188-196.
- MIL-STD 188-198A.
- MIL-STD 188-199, *Vector Quantization Decompression for the National Imagery Transmission Format Standard.*
- MIL-STD 2500C, *National Imagery Transmission Format (Version 2.1) for the National Imagery Transmission Format Standard.*
- MISP version 6.4.
- NGA Standard Identification (STDI)-0001 V1.3/CN2, *National Support Data Extension (SDE) (Version 1.3/CN2) for the National Imagery Transmission Format (NITF).*
- NGA STDI-006, *National Imagery Transmission Format (NITF) Version 2.1 Commercial Dataset Requirements Document (NCDRD).*

# **APPENDIX K**

## **IMAGERY INTELLIGENCE APPENDIX FORMAT**

The IMINT operations appendix should explain how IMINT and relevant imagery-related elements under the operational control of or supporting the MAGTF will be used to support this plan. It should also provide guidance to subordinate commanders for the conduct of IMINT operations and the support of IMINT elements and personnel identified to fulfill the IMINT requirements.

CLASSIFICATION

Copy no. \_\_\_ of \_\_\_ copies  
OFFICIAL DESIGNATION OF COMMAND  
PLACE OF ISSUE  
Date-time group  
Message reference number

APPENDIX 7 TO ANNEX B (INTELLIGENCE) TO MAGTF OPORD XXX (U)  
IMAGERY INTELLIGENCE (U)

(U) REFERENCES: Identify DOD, NGA, and other directives; combatant commander, JTF, or other higher authorities' OPORDs and TTP or SOP for intelligence and IMINT operations; pertinent maps and other geospatial information resources; and any other relevant references that pertain to anticipated IMINT operations.

1. (U) Situation

- a. (U) Definition of the AO and AOI. Describe the limits of the AO and AOI. Summarize pertinent weather, terrain, and other AO's characteristics and conditions that may influence the conduct of IMINT operations.
- b. (U) Enemy. Refer to annex B and current intelligence estimates for threat capabilities, limitations, vulnerabilities, and OOB pertinent to IMINT operations.
- c. (U) Assigned MAGTF Organic and Supporting IMINT Assets. Identify organic and supporting forces available to perform IMINT and imagery-related functions.
- d. (U) Facts and Assumptions. Derived during the mission analysis step of the MCPP.
- e. (U) IMINT Considerations. List key IMINT, intelligence, or other considerations that impact this OPLAN or CONPLAN.
  - (1) (U) Availability of national source and commercial imagery.
  - (2) (U) IMINT support to and from JTF and other component headquarters.
  - (3) (U) Creation and manning of forward IMINT elements.

## CLASSIFICATION

2. (U) Mission. State concisely the IMINT mission as it relates to the command's planned operation.
3. (U) Execution
  - a. (U) Concept of Operations. Reference the unit's intelligence SOP and Appendix 16 (Intelligence Operations Plan) to annex B. Restate as appropriate the commander's intent and pertinent aspects of the unit's overall CONOPS as they relate to IMINT operations. Outline the purpose and concept of IMINT operations; specify priorities; and summarize the means and agencies to be employed in planning and directing, collecting, processing and exploiting, analyzing and producing, disseminating, and using IMINT during execution of the OPORD. Address the integration of JTF, other components, theater, national, and allied forces' IMINT operations.
  - b. (U) Tasks for IMINT and Related Units and Organizations, Subordinate Units, and Task Force Commanders/OICs
    - (1) (U) Orders to Subordinate, Attached, and Supporting Units. Use separate numbered subparagraphs to list detailed instructions for each unit conducting IMINT operations, including the originating headquarters, subordinate commands, and separate intelligence support units.
      - (a) (U) Major subordinate commanders.
      - (b) (U) Commanding officer, intelligence battalion.
        - 1 Platoon commander, IIP.
        - 2 MTI section.
        - 3 Staff noncommissioned officers in charge (SNCOICs), direct support teams.
        - 4 OIC, support cell.
        - 5 OIC, surveillance and reconnaissance cell.
        - 6 OIC, P&A cell.
        - 7 Others, as appropriate.



## CLASSIFICATION

- (c) (U) Commanding officer, VMU.
  - (d) (U) Commanding officer, force reconnaissance company.
- (2) (U) Requests to Higher, Adjacent, and Cooperating Units. Provide separate numbered subparagraphs pertaining to each unit not organic, attached, or supporting and from which IMINT support is requested, including other components, JTF headquarters, allied or coalition forces, theater and national operational and intelligence elements.
- c. (U) Coordinating Instructions. Reference Appendix 16 (Intelligence Operations Plan) and command and other pertinent forces' and organizations' intelligence and counterintelligence SOPs. Detail key changes to SOPs here or in supporting tabs. Additional topics to include or emphasize here include requesting IMINT support; direct liaison among subordinate commanders, MAGTF IMINT units, staff officers, and pertinent external organizations and agencies; and routine and time-sensitive reporting procedures and formats.
4. (U) Administration and Logistic
- a. (U) Logistics. Reference Annex D (Logistics). Identify IMINT unique logistic requirements and concerns, such as any unique combat service support requirements, procedures, and other guidance to support MAGTF IMINT units and operations or procedures for specialized technical logistic support necessary from external organizations.
  - b. (U) Personnel. Identify intelligence unique IMINT personnel requirements and concerns.
5. (U) Command and Control
- a. (U) Command Relationships. Reference Annex J (Command Relationships). Provide any instructions necessary regarding MAGTF command relationships that will influence unit IMINT operations.
  - b. (U) Information Management. Reference Annex U (Information Management), Annex C (Operations), and Appendix 16 (Intelligence Operations Plan). Provide any necessary instructions regarding information management (e.g., time-sensitive and routine reporting criteria, intelligence databases, reports) that will influence MAGTF IMINT operations.
  - c. (U) Communications and Information Systems. Reference Appendix 16 (Intelligence Operations Plan) and Annex K (Communications and Information Systems). Provide any instructions necessary regarding CIS that will influence MAGTF IMINT operations.

CLASSIFICATION

- d. (U) Intelligence C2 Nodes and Facilities. Reference the unit's intelligence SOP and Appendix 16 (Intelligence Operations Plan). Provide guidance and necessary instructions regarding the establishment and operations of intelligence and IMINT C2 nodes and facilities (e.g., the surveillance and reconnaissance cell).

TABS: (As necessary)

# APPENDIX L

## UNMANNED AIRCRAFT SYSTEM FORMATS

### Unmanned Aircraft System Plan

#### CLASSIFICATION

Copy no. \_\_\_\_\_ of \_\_\_\_\_ copies

OFFICIAL DESIGNATION OF COMMAND

PLACE OF ISSUE

Date-time group

Message reference number

TAB C TO APPENDIX 14 TO ANNEX B TO OPLAN XXX (U)

UNMANNED AIRCRAFT SYSTEM PLAN (U)

(U) REFERENCES: (As appropriate).

1. (U) Mission. Conduct real-time surveillance, target acquisition, and imagery intelligence throughout the MAGTF area of responsibility until termination of hostilities, per Annex B (Intelligence) and Annex C (Operations) to the MAGTF OPLAN.
2. (U) Execution. The VMU will provide UAS and C2 crews in support of MAGTF operations. The MAGTF G-2, in coordination with the G-3, will exercise operational control of all tactical surveillance unmanned aircraft within the AO unless otherwise directed. The ISC, under the staff cognizance of the AC/S G-2, plans, coordinates, and supervises MAGTF UAS intelligence missions.
3. (U) Tasks. Detachment, \_\_\_\_\_, \_\_\_\_\_ VMU will—
  - a. (U) Prepare a UAS employment plan and overlay to depict the UAS concept of employment supporting combat operations ashore and submit these to the MAGTF G-2 (attn: ISC or CM/DO).

CLASSIFICATION

- b. (U) Assign surveillance UAS equipment and personnel to provide real time video/imagery intelligence in support of MAGTF operations as directed by Annex B (Intelligence) to the MAGTF OPLAN, daily ATOs, and other intelligence orders.
  - c. (U) Provide remote receiving station detachments at designated locations afloat and ashore.
  - d. (U) Initiate action to obtain approved frequencies for UAS support, per Annex K (CIS) to the MAGTF OPLAN.
  - e. (U) Coordinate flight operations through appropriate air control agencies as assigned in Annex N (Aviation Operations) to the MAGTF OPLAN.
4. (U) MAGTF UAS Surveillance Sectors/Routes. To facilitate the assignment and coordination of tactical surveillance missions, UAS loiter areas and surveillance routes are designated in the enclosures to this tab.

ENCLOSURES:

1-UAS Employment Plan

2-UAS Employment Overlay

**Unmanned Aircraft System Employment Plan**

CLASSIFICATION

Copy no. \_\_\_\_\_ of \_\_\_\_\_ copies

OFFICIAL DESIGNATION OF COMMAND

PLACE OF ISSUE

Date-time group

Message reference number

ENCLOSURE 1 TO TAB C TO APPENDIX 14 TO ANNEX B TO OPLAN XXX  
 UAS EMPLOYMENT PLAN

(U) REFERENCES: (a) Maps: NGA stock no. \_\_\_\_\_

The following UAS and surveillance routes, targets, and loiter areas have been preplanned in support of MAGTF operations:

*Note:*

- 1) Tasked intelligence requirements and reporting criteria.
- 2) Others, as appropriate.

MSN NUMBER	COORDINATES	ALT	TOT	FOOTNOTES
	_____to	TBD	TBD	
	_____to			
	_____to			
	_____to			
	Close			
	_____to	TBD	TBD	
	_____to			
	_____to			
	_____to			
	Close			

# APPENDIX M

## AERIAL IMAGERY PLAN FORMAT

CLASSIFICATION

Copy no. \_\_\_ of \_\_\_ copies  
 OFFICIAL DESIGNATION OF COMMAND  
 PLACE OF ISSUE  
 Date-time group  
 Message reference number

TAB D TO APPENDIX 14 TO ANNEX B TO OPLAN XXX (U)  
 AERIAL IMAGERY PLAN (U)

(U) REFERENCES: (a) Maps. See Appendix 15 (Geographic Intelligence) to Annex B (Intelligence) and Annex M (GI&S).

1. The following aerial imagery missions have been preplanned.

MSN NO.	COORD	PHOTO			SLR MODE	IR/ALT	DATE OF MSN	REMARKS
		VERT OR OBL	OVERLAP	FILM SCALE				
1.	XXXXX	VERT	60%	B&W	Low	N/A	D-30	Basic
	XXXXX		FOR	1:20K	ALT			Coverage
	XXXXX		40%		Mode			
	XXXXX				10B			
2.	XXXXX	VERT	60%	B&W	Low	D-3 Only	D-1	Beach
	XXXXX		FOR	Color	ALT			Study
	XXXXX		40%	& CD	MTIR			Survey
	XXXXX		SIDE	1:5K	Or MTIR			
3.	N/A	N/A	N/A	N/A	N/A	N/A	D+1	On call

# GLOSSARY

## Section I. Acronyms

AAA.....	antiaircraft artillery
AC/S.....	assistant chief of staff
ACE.....	aviation combat element
AFP.....	all-source fusion platoon
ALT.....	altitude
AMC.....	air mission commander
AO.....	area of operations
AOI.....	area of interest
ATARS.....	advanced tactical airborne reconnaissance system
ATF.....	amphibious task force
ATO.....	air tasking order
BDA.....	battle damage assessment
BE.....	basic encyclopedia
BLS.....	beach landing site
C2.....	command and control
CCD.....	camouflage, concealment, and deception
CCIR.....	commander's critical information requirement
CCMD.....	combatant command
CDE.....	collateral damage estimation
CDL.....	common data link
CGS.....	common ground station
CIA.....	Central Intelligence Agency
CIC.....	combat intelligence center
CIS.....	communications and information systems
CJCSI.....	Chairman of the Joint Chiefs of Staff instruction
CLS.....	contractor logistics support
cm.....	centimeter(s)
CM.....	collection manager
CM/DO.....	collection management/dissemination officer
CMD.....	command
COA.....	course of action
COC.....	combat operations center
CONOPS.....	concept of operations
CONPLAN.....	concept plan
COP.....	common operational picture
CSA.....	combat support agency
CTP.....	common tactical picture

DASC	direct air support center
DCGS	distributed common ground/surface system
DCGS-MC	distributed common ground/surface system-Marine Corps
DCT	discrete cosine transform
DIA	Defense Intelligence Agency
DIB	distributed common ground/surface system integration backbone
DIRINT	Director of Intelligence
DMRF	denominator of the map representative scale factor
DNI	Director of National Intelligence
DOD	Department of Defense
DODIPP	Department of Defense Intelligence Production Program
DPRF	denominator of the photo representative scale factor
DRO	departmental requirements office
DZ	drop zone
EI	essential element of information
EID	entity identifier
EO	electro-optical
ETF	electronic target folder
EW	electronic warfare
FDCT	forward discrete cosine transform
FLIR	forward-looking infrared
FMV	full motion video
FOC	future operations cell
FoS	family of systems
FSCC	fire support coordination center
FSR	field service representative
ft	foot (feet)
FTI	fixed target indicator
G-1	manpower or personnel staff officer
G-2	intelligence staff officer
G-3	operations staff officer
G-4	logistics staff officer
G-5	assistant chief of staff, plans
G-6	command, control, communications, and computer systems staff officer
GD	ground distance
GDT	ground data terminal
GEOINT	geospatial intelligence
GI&S	geospatial information and services
HD	horizontal distance
HLZ	helicopter landing zone
HQMC	Headquarters, Marine Corps
HQMC-IP	Headquarters, Marine Corps-Imagery & Geospatial Intelligence Branch
HUMINT	human intelligence



I&W .....	indications and warning
IAS .....	intelligence analysis system
IC .....	intelligence community
ICBM .....	intercontinental ballistic missile
ICR .....	intelligence collection requirement
IIP .....	imagery intelligence platoon
IMINT .....	imagery intelligence
IMR .....	imagery reference
IOC .....	intelligence operations center
IPB .....	intelligence preparation of the battlespace
IPIR .....	initial photographic interpretation report
ISC .....	intelligence support coordinator
ISR .....	intelligence, surveillance, and reconnaissance
J-2 .....	intelligence staff section
JAS .....	JSTARS antenna suite
JFC .....	joint force commander
JIOC .....	joint intelligence operations center
JISE .....	joint intelligence support element
JP .....	joint publication
JPEG .....	Joint Photographic Experts Group
JSTARS .....	Joint Surveillance Target Attack Radar System
JTAR/S .....	joint tactical air reconnaissance/surveillance
JTF .....	joint task force
JWICS .....	Joint Worldwide Intelligence Communications System
km .....	kilometers
kts .....	knots
LAN .....	local area network
LCE .....	logistics combat element
LOC .....	line of communications
LOS .....	line of sight
LP .....	landing point
LSI .....	lead systems integrator
LSRS .....	littoral surveillance radar system
LTIOV .....	latest time information is of value
LZ .....	landing zone
m .....	meter(s)
MACCS .....	Marine air command and control system
MACG .....	Marine air control group
MAGTF .....	Marine air-ground task force
MARFORRES .....	United States Marine Corps Forces Reserve
MASINT .....	measurement and signature intelligence
MAW .....	Marine aircraft wing
MC .....	MOVINT client

MCIA .....	Marine Corps Intelligence Activity
MCISR-E .....	Marine Corps Intelligence, Surveillance, and Reconnaissance-Enterprise
MCO .....	Marine Corps order
MCPP .....	Marine Corps Planning Process
MCRP .....	Marine Corps reference publication
MARCORSYSCOM.....	Marine Corps Systems Command
MCWP .....	Marine Corps warfighting publication
MEF .....	Marine expeditionary force
METOC .....	meteorological and oceanographic
METT-T .....	mission, enemy, terrain and weather, troops and support available-time available
MEU .....	Marine expeditionary unit
MIDB .....	modernized integrated database
MIPIR .....	multimission imagery photo interpretation report
MISP .....	Motion Imagery Standards Profile
MLG.....	Marine logistics group
MOJT .....	managed on-the-job training
MOS.....	military occupational specialty
MOUT.....	military operations on urbanized terrain
MSC .....	major subordinate command
MSN.....	mission
MTI.....	moving target indicator
MTI OS.....	moving target indicator operation suite
NATO .....	North Atlantic Treaty Organization
NGA .....	National Geospatial-Intelligence Agency
NIIRS .....	National Imagery Interpretability Rating Scale
NIPRNET.....	Nonsecure Internet Protocol Router Network
NIST.....	national intelligence support team
NITF.....	national imagery transmission format
NRO .....	National Reconnaissance Office
NRT .....	near real time
NSA .....	National Security Agency
NSG .....	National System for Geospatial Intelligence
NST .....	National Geospatial-Intelligence Agency support team
OIC.....	officer in charge
OOB .....	order of battle (also known as OB)
OPLAN .....	operation plan
OPORD.....	operation order
P&A .....	production and analysis
PD .....	photo distance
PIR .....	priority intelligence requirement
POL.....	petroleum, oils, and lubricants
RECCEXREP .....	reconnaissance exploitation report
RFI .....	request for intelligence

RPG.....	rocket propelled grenade
RVT .....	remote video terminal
S-2.....	intelligence staff officer
S-3.....	operations staff officer
S-4.....	logistics staff officer
S-6.....	communications system officer
SALUTE .....	size, activity, location, unit, time, and equipment
SAM.....	surface-to-air missile
SAR.....	synthetic aperture radar
SARC.....	surveillance and reconnaissance center
SATCOM.....	satellite communications
SCDL .....	surveillance control data link
SIDS.....	secondary imagery dissemination system
SIGINT .....	signals intelligence
SIPRNET .....	SECRET Internet Protocol Router Network
SL.....	percent of slope
SOP.....	standing operating procedure
SRBM .....	short-range ballistic missile
SUPIR.....	supplemental photographic interpretation report
TACC.....	tactical air command center
TACTEX.....	tactical analysis and combat tracking exploitation
TCPED.....	tasking, collection, processing, exploitation, and dissemination
TDN .....	tactical data network
TEG.....	tactical exploitation group
TEG-RWS.....	tactical exploitation group-remote workstation
TEL.....	transporter-erector-launcher
TOT.....	time on target
TTP .....	tactics, techniques, and procedures
UAS .....	unmanned aircraft system
US.....	United States
UTM.....	universal transverse mercator
VADER.....	vehicle and dismount exploitation radar
VAS .....	vantage ascent software
VD.....	vertical distance
VHF .....	very high frequency
VIP-MC .....	virtual imagery processing-Marine Corps
VMFA(AW).....	Marine fighter/attack (all weather) squadron
VMU .....	Marine unmanned aerial vehicle squadron
WAN.....	wide-area network

**Section II. Definitions**

**airfield**—An area prepared for the accommodation (including any buildings, installations, and equipment), landing, and takeoff of aircraft. See also **departure airfield**; **landing area**; **landing site**. (JP 1-02)

**all-source intelligence**—1. Intelligence products and/or organizations and activities that incorporate all sources of information, most frequently including human intelligence, imagery intelligence, measurement and signature intelligence, signals intelligence, and open-source data in the production of finished intelligence. 2. In intelligence collection, a phrase that indicates that in the satisfaction of intelligence requirements, all collection, processing, exploitation, and reporting systems and resources are identified for possible use and those most capable are tasked. (JP 1-02)

**amphibious force**—An amphibious task force and a landing force together with other forces that are trained, organized, and equipped for amphibious operations. Also called **AF**. (JP 1-02)

**area of interest**—That area of concern to the commander, including the area of influence, areas adjacent thereto, and extending into enemy territory. This area also includes areas occupied by enemy forces who could jeopardize the accomplishment of the mission. Also called **AOI**. (JP 1-02)

**area of operations**—An operational area defined by the joint force commander for land and maritime forces that should be large enough to accomplish their missions and protect their forces. Also called **AO**. (JP 1-02)

**assessment**—3. Analysis of the security, effectiveness, and potential of an existing or planned intelligence activity. 4. Judgment of the motives, qualifications, and characteristics of present or prospective employees or “agents.” (JP 1-02) (Parts 3 and 4 of a 4-part definition.)

**attach**—1. The placement of units or personnel in an organization where such placement is relatively temporary. 2. The detailing of individuals to specific functions where such functions are secondary or relatively temporary. (JP 1-02)

**aviation combat element**—The core element of a Marine air-ground task force (MAGTF) that is task-organized to conduct aviation operations. The aviation combat element (ACE) provides all or a portion of the six functions of Marine aviation necessary to accomplish the MAGTF’s mission. These functions are anti-air warfare, offensive air support, assault support, electronic warfare, air reconnaissance, and control of aircraft and missiles. The ACE is usually composed of an aviation unit headquarters and various other aviation units or their detachments. It can vary in size from a small aviation detachment of specifically required aircraft to one or more Marine aircraft wings. In a joint or multinational environment, the ACE may contain other Service or multinational forces assigned or attached to the MAGTF. The ACE itself is not a formal command. Also called **ACE**. (MCRP 5-12C)

**battle damage assessment**—The estimate of damage composed of physical and functional damage assessment, as well as target system assessment, resulting from the application of lethal or nonlethal military force. (JP 1-02) The timely and accurate estimate of the damage resulting from the application of military force. Battle damage assessment estimates physical damage to a

particular target, functional damage to that target, and the capability of the entire target system to continue its operations. Also called **BDA**. (MCRP 5-12C)

**battlespace**—The environment, factors, and conditions that must be understood to successfully apply combat power, protect the force, or complete the mission. This includes the air, land, sea, space, and the included enemy and friendly forces; facilities; weather; terrain; the electromagnetic spectrum; and the information environment within the operational areas, areas of interest, and areas of influence. (MCRP 5-12C)

**beach**—1. The area extending from the shoreline inland to a marked change in physiographic form or material, or to the line of permanent vegetation (coastline). 2. In amphibious operations, that portion of the shoreline designated for landing of a tactical organization. (JP 1-02)

**beachhead**—A designated area on a hostile or potentially hostile shore that, when seized and held, ensures the continuous landing of troops and materiel, and provides maneuver space requisite for subsequent projected operations ashore. (JP 1-02)

**beach width**—The horizontal dimensions of the beach measured at right angles to the shoreline from the line of extreme low water inland to the landward limit of the beach (the coastline). (JP 1-02)

**collection**—(See JP 1-02 for core definition. Marine Corps amplification follows.) The gathering of intelligence data and information to satisfy the identified requirements. (MCRP 5-12C)

**collection management**—In intelligence usage, the process of converting intelligence requirements into collection requirements, establishing priorities, tasking or coordinating with appropriate collection sources or agencies, monitoring results, and retasking, as required. (JP 1-02)

**collection plan**—A plan for collecting information from all available sources to meet intelligence requirements and for transforming those requirements into orders and requests to appropriate agencies. (JP 1-02)

**collection requirement**—2. An established intelligence need, validated against the appropriate allocation of intelligence resources (as a requirement) to fulfill the essential elements of information and other intelligence needs of an intelligence consumer. (JP 1-02) (Part 2 of a 2-part definition.)

**combatant commander**—A commander of one of the unified or specified combatant commands established by the President. Also called **CCDR**. (JP 1-02)

**command and control**—(See JP1-02 for core definition. Marine Corps amplification follows.) The means by which a commander recognizes what needs to be done and sees to it that appropriate actions are taken. Command and control is one of the six warfighting functions. Also called **C2**. (MCRP 5-12C)

**command element**—The core element of a Marine air-ground task force (MAGTF) that is the headquarters. The command element is composed of the commander, general or executive and special staff sections, headquarters section, and requisite communications support, intelligence, and reconnaissance forces, necessary to accomplish the MAGTF's mission. The command element provides command and control, intelligence, and other support essential for effective planning and execution of operations by the other elements of the MAGTF. The command element varies in size and composition; and, in a joint or multinational environment, it may contain other Service or multinational forces assigned or attached to the MAGTF. Also called **CE**. (MCRP 5-12C)

**commander's critical information requirement(s)**—(See JP1-02 for core definition. Marine Corps amplification follows.) Information regarding the enemy and friendly activities and the environment identified by the commander as critical to maintaining situational awareness, planning future activities, and facilitating timely decisionmaking. The two subcategories are priority intelligence requirements and friendly force information requirements. Also called **CCIRs**. (MCRP 5-12C)

**commander's intent**—(See JP1-02 for core definition. Marine Corps amplification follows.) A commander's clear, concise articulation of the purpose(s) behind one or more tasks assigned to a subordinate. It is one of two parts of every mission statement which guides the exercise of initiative in the absence of instructions. (MCRP 5-12C)

**contingency**—A situation requiring military operations in response to natural disasters, terrorists, subversives, or as otherwise directed by appropriate authority to protect US interests. (JP 1-02)

**control**—1. Authority that may be less than full command exercised by a commander over part of the activities of subordinate or other organizations. 2. In mapping, charting, and photogrammetry, a collective term for a system of marks or objects on the Earth or on a map or a photograph, whose positions or elevations (or both) have been or will be determined. 3. Physical or psychological pressures exerted with the intent to assure that an agent or group will respond as directed. 4. An indicator governing the distribution and use of documents, information, or material. Such indicators are the subject of intelligence community agreement and are specifically defined in appropriate regulations. (JP 1-02)

**coordination**—The action necessary to ensure adequately integrated relationships between separate organizations located in the same area. Coordination may include such matters as fire support, emergency defense measures, area intelligence, and other situations in which coordination is considered necessary. (MCRP 5-12C)

**counterintelligence**—(See JP1-02 for core definition. Marine Corps amplification follows.) The active and passive measures intended to deny the enemy valuable information about the friendly

situation, to detect and neutralize hostile intelligence collection, and to deceive the enemy as to friendly capabilities and intentions. (MCRP 5-12C)

**countermeasures**—That form of military science that, by the employment of devices and/or techniques, has as its objective the impairment of the operational effectiveness of enemy activity. (JP 1-02)

**current intelligence**—One of two categories of descriptive intelligence that is concerned with describing the existing situation. (JP 1-02)

**damage assessment**—1. The determination of the effect of attacks on targets. 2. A determination of the effect of a compromise of classified information on national security. (JP 1-02)

**detachment**—1. A part of a unit separated from its main organization for duty elsewhere. 2. A temporary military or naval unit formed from other units or parts of units. (AAP-06)

**dissemination**—Conveyance of intelligence to users in a suitable form. (MCRP 5-12C)

**drop zone**—A specific area upon which airborne troops, equipment, or supplies are airdropped. Also called **DZ**. (JP 1-02)

**essential elements of friendly information**—(See JP1-02 for core definition. Marine Corps amplification follows.) Specific facts about friendly intentions, capabilities, and activities needed by adversaries to plan and execute effective operations against our forces. Also called **EEFI**. (MCRP 5-12C)

**fires**—(See JP1-02 for core definition. Marine Corps amplification follows.) Those means used to delay, disrupt, degrade, or destroy enemy capabilities, forces, or facilities as well as affect the enemy's will to fight. Fires is one of the six warfighting functions. (MCRP 5-12C)

**force protection**—(See JP1-02 for core definition. Marine Corps amplification follows.) Actions or efforts used to safeguard own centers of gravity while protecting, concealing, reducing, or eliminating friendly critical vulnerabilities. Force protection is one of the six warfighting functions. (MCRP 5-12C)

**fusion**—In intelligence usage, the process of examining all sources of intelligence and information to derive a complete assessment of activity. (JP 1-02)

**global sourcing**—A process of force provision or augmentation whereby resources may be drawn from any location/command worldwide. (MCRP 5-12C)

**ground combat element**—The core element of a Marine air-ground task force (MAGTF) that is task-organized to conduct ground operations. It is usually constructed around an infantry organization but can vary in size from a small ground unit of any type to one or more Marine divisions that can be independently maneuvered under the direction of the MAGTF commander. It includes appropriate ground combat and combat support forces, and in a joint or multinational environment, it may also contain other Service or multinational forces assigned or attached to the

**MAGTF.** The ground combat element itself is not a formal command. Also called **GCE**. (MCRP 5-12C)

**helicopter landing zone**—A specified ground area for landing assault helicopters to embark or disembark troops and/or cargo. A landing zone may contain one or more landing sites. Also called **HLZ**. (JP 1-02)

**human intelligence**—A category of intelligence derived from information collected and provided by human sources. Also called **HUMINT**. (JP 1-02)

**human intelligence operations**—Operations that cover a wide range of activities encompassing reconnaissance patrols, aircrew reports and debriefs, debriefing of refugees, interrogations of prisoners of war, and the conduct of counterintelligence force protection source operations. Also called **HUMINT operations**. (MCRP 5-12C)

**imagery**—A likeness or presentation of any natural or man-made feature or related object or activity, and the positional data acquired at the same time the likeness or representation was acquired, including: products produced by space-based national intelligence reconnaissance systems; and likeness and presentations produced by satellites, airborne platforms, unmanned aerial vehicles, or other similar means (except that such term does not include handheld or clandestine photography taken by or on behalf of human intelligence collection organizations). (JP 1-02)

**imagery exploitation**—The cycle of processing and printing imagery to the positive or negative state, assembly into imagery packs, identification, interpretation, mensuration, information extraction, the preparation of reports, and the dissemination of information. (JP 1-02)

**imagery intelligence**—The technical, geographic, and intelligence information derived through the interpretation or analysis of imagery and collateral materials. Also called **IMINT**. (JP 1-02)

**imagery interpretation**—1. The process of location, recognition, identification, and description of objects, activities, and terrain represented on imagery. 2. The extraction of information from photographs or other recorded images. (AAP-6)

**indications**—In intelligence usage, information in various degrees of evaluation, all of which bear on the intention of a potential enemy to adopt or reject a course of action. (JP 1-02)

**indications and warning**—Those intelligence activities intended to detect and report time-sensitive intelligence information on foreign developments that could involve a threat to the United States or allied and/or coalition military, political, or economic interests or to US citizens abroad. It includes forewarning of hostile actions or intentions against the United States, its activities, overseas forces, or allied and/or coalition nations. Also called **I&W**. (JP 1-02)

**indicator**—In intelligence usage, an item of information which reflects the intention or capability of an adversary to adopt or reject a course of action. (JP 1-02)



**information**—Unprocessed data of every description which may be used in the production of intelligence. (AAP-06)

**information requirements**—In intelligence usage, those items of information regarding the adversary and other relevant aspects of the operational environment that need to be collected and processed in order to meet the intelligence requirements of a commander. (JP 1-02)

**infrared imagery**—That imagery produced as a result of sensing electromagnetic radiations emitted or reflected from a given target surface in the infrared position of the electromagnetic spectrum (approximately 0.72 to 1,000 microns). (JP 1-02)

**integration**—3. In photography, a process by which the average radar picture seen on several scans of the time base may be obtained on a print, or the process by which several photographic images are combined into a single image. (JP 1-02) (Part 3 of a 3-part definition.)

**intelligence**—(See JP1-02 for core definition. Marine Corps amplification follows.) Knowledge about the enemy or the surrounding environment needed to support decisionmaking. Intelligence is one of the six warfighting functions. (MCRP 5-12C)

**intelligence data**—Data derived from assets primarily dedicated to intelligence collection such as imagery systems, electronic intercept equipment, human intelligence sources, etc. (MCRP 5-12C)

**intelligence discipline**—A well-defined area of intelligence planning, collection, processing, exploitation, analysis, and reporting using a specific category of technical or human resources. There are seven major disciplines: human intelligence, geospatial intelligence, measurement and signature intelligence, signals intelligence, open-source intelligence, technical intelligence, and counterintelligence. (JP 1-02)

**intelligence estimate**—The appraisal, expressed in writing or orally, of available intelligence relating to a specific situation or condition with a view to determining the courses of action open to the enemy or adversary and the order of probability of their adoption. (JP 1-02)

**intelligence preparation of the battlespace**—(See JP1-02 for core definition. Marine Corps amplification follows.) The systematic, continuous process of analyzing the threat and environment in a specific geographic area. Also called **IPB**. (MCRP 5-12C)

**intelligence-related activities**—Those activities outside the consolidated defense intelligence program that: respond to operational commanders' tasking for time-sensitive information on foreign entities; respond to national intelligence community tasking of systems whose primary mission is support to operating forces; train personnel for intelligence duties; provide an intelligence reserve; or are devoted to research and development of intelligence or related capabilities. (Specifically excluded are programs that are so closely integrated with a weapon system that their primary function is to provide immediate-use targeting data.) (JP 1-02)

**intelligence report**—A specific report of information, usually on a single item, made at any level of command in tactical operations and disseminated as rapidly as possible in keeping with the timeliness of the information. Also called **INTREP**. (JP 1-02)

**intelligence reporting**—The preparation and conveyance of information by any means. More commonly, the term is restricted to reports as they are prepared by the collector and as they are transmitted by the collector to the latter's headquarters and by this component of the intelligence structure to one or more intelligence-producing components. Thus, even in this limited sense, reporting embraces both collection and dissemination. The term is applied to normal and specialist intelligence reports. (JP 1-02)

**intelligence requirement(s)**—(See JP1-02 for core definition. Marine Corps amplification follows.) Questions about the enemy and the environment, the answers to which a commander requires to make sound decisions. Also called **IRs**. (MCRP 5-12C)

**interpretation**—(See JP1-02 for core definition. Marine Corps amplification follows.) A part of the production phase in the Marine Corps intelligence cycle that supports the commander's decisionmaking process. (MCRP 5-12C)

**joint force**—A general term applied to a force composed of significant elements, assigned or attached, of two or more Military Departments operating under a single joint force commander. (JP 1-02)

**joint force commander**—A general term applied to a combatant commander, subunified commander, or joint task force commander authorized to exercise combatant command (command authority) or operational control over a joint force. Also called **JFC**. (JP 1-02)

**joint intelligence**—Intelligence produced by elements of more than one Service of the same nation. (JP 1-02)

**joint intelligence operations center**—An interdependent, operational intelligence organization at the Department of Defense, combatant command, or joint task force (if established) level, that is integrated with national intelligence centers, and capable of accessing all sources of intelligence impacting military operations planning, execution, and assessment. Also called **JIOC**. (JP 1-02)

**Joint Worldwide Intelligence Communications System**—The sensitive, compartmented information portion of the Defense Information Systems Network. It incorporates advanced networking technologies that permit point-to-point or multipoint information exchange involving voice, text, graphics, data, and video teleconferencing. Also called **JWICS**. (JP 1-02)

**landing area**—1. That part of the operational area within which are conducted the landing operations of an amphibious force. It includes the beach, the approaches to the beach, the transport areas, the fire support areas, the airspace above it, and the land included in the advance inland to the initial objective. 2. (Airborne) The general area used for landing troops and materiel either by airdrop or air landing. This area includes one or more drop zones or landing strips. 3. Any specially prepared or selected surface of land, water, or deck designated or used for takeoff and landing of aircraft. See also **airfield**; **amphibious force**; **landing beach**; **landing force**. (JP 1-02)

**landing beach**—That portion of a shoreline usually required for the landing of a battalion landing team. However, it may also be that portion of a shoreline constituting a tactical locality (such as the shore of a bay) over which a force larger or smaller than a battalion landing team may be landed. (JP 1-02)

**landing force**—A Marine Corps or Army task organization formed to conduct amphibious operations. The landing force, together with the amphibious task force and other forces, constitute the amphibious force. Also called **LF**. (JP 1-02)

**liaison**—That contact or intercommunication maintained between elements of military forces or other agencies to ensure mutual understanding and unity of purpose and action. (JP 1-02)

**logistics**—(See JP1-02 for core definition. Marine Corps amplification follows.) 1. The science of planning and executing the movement and support of forces. 2. All activities required to move and sustain military forces. Logistics is one of the six warfighting functions. (MCRP 5-12C)

**logistics combat element**—The core element of a Marine air-ground task force (MAGTF) that is task-organized to provide the combat service support necessary to accomplish the MAGTF's mission. The logistics combat element varies in size from a small detachment to one or more Marine logistics groups. It provides supply, maintenance, transportation, general engineering, health services, and a variety of other services to the MAGTF. In a joint or multinational environment, it may also contain other Service or multinational forces assigned or attached to the MAGTF. The logistics combat element itself is not a formal command. Also called **LCE**. (MCRP 5-12C)

**main effort**—The designated subordinate unit whose mission at a given point in time is most critical to overall mission success. It is usually weighted with the preponderance of combat power and is directed against a center of gravity through a critical vulnerability. (MCRP 5-12C)

**maneuver**—The movement of forces for the purpose of gaining an advantage over the enemy. Maneuver is one of the six warfighting functions. (MCRP 5-12C)

**Marine air-ground task force**—The Marine Corps' principal organization for all missions across a range of military operations, composed of forces task-organized under a single commander capable of responding rapidly to a contingency anywhere in the world. The types of forces in the Marine air-ground task force (MAGTF) are functionally grouped into four core elements: a command element, an aviation combat element, a ground combat element, and a logistics combat element. The four core elements are categories of forces, not formal commands. The basic structure of the MAGTF never varies, though the number, size, and type of Marine Corps units comprising each of its four elements will always be mission dependent. The flexibility of the organizational structure allows for one or more subordinate MAGTFs to be assigned. In a joint or multinational environment, other Service or multinational forces may be assigned or attached. Also called **MAGTF**. (MCRP 5-12C)

**Marine Corps Planning Process**—A six-step methodology which helps organize the thought processes of the commander and staff throughout the planning and execution of military operations. It focuses on the mission and the threat and is based on the Marine Corps philosophy

of maneuver warfare. It capitalizes on the principle of unity of command and supports the establishment and maintenance of tempo. The six steps consist of problem framing, course of action development, course of action war game, course of action comparison and decision, orders development, and transition. Also called **MCPP**. (*Note: Tenets of the MCPP include top-down planning, single-battle concept, and integrated planning.*) (MCRP 5-12C)

**Marine expeditionary force**—The largest Marine air-ground task force (MAGTF) and the Marine Corps' principal warfighting organization, particularly for larger crises or contingencies. It is task-organized around a permanent command element and normally contains one or more Marine divisions, Marine aircraft wings, and Marine logistic groups. The Marine expeditionary force is capable of missions across the range of military operations, including amphibious assault and sustained operations ashore in any environment. It can operate from a sea base, a land base or both. In a joint or multinational environment, it may also contain other Service or multinational forces assigned or attached to the MAGTF. Also called **MEF**. (MCRP 5-12C)

**Marine expeditionary unit**—A Marine air-ground task force (MAGTF) that is constructed around an infantry battalion reinforced, a composite squadron reinforced, and a task-organized logistics combat element. It normally fulfills Marine Corps' forward sea-based deployment requirements. The Marine expeditionary unit provides an immediate reaction capability for crisis response and is capable of limited combat operations. In a joint or multinational environment, it may contain other Service or multinational forces assigned or attached to the MAGTF. Also called **MEU**. (MCRP 5-12C)

**measurement and signature intelligence**—Intelligence obtained by quantitative and qualitative analysis of data (metric, angle, spatial, wavelength, time dependence, modulation, plasma, and hydromagnetic) derived from specific technical sensors for the purpose of identifying any distinctive features associated with the emitter or sender, and to facilitate subsequent identification and/or measurement of the same. The detected feature may be either reflected or emitted. Also called **MASINT**. (JP 1-02)

**multispectral imagery**—The image of an object obtained simultaneously in a number of discrete spectral bands. Also called **MSI**. (JP 1-02)

**National Imagery Transmission Format Standard**—The suite of standards for formatting digital imagery and imagery-related products and exchanging them among members of the Intelligence Community (IC) as defined by the Executive Order 12333, and other United States Government departments and agencies. Also called **NITFS**. (MIL-STD-2500C)

**national intelligence**—All intelligence, regardless of the source from which derived, and including that which is gathered within or outside the United States, that pertains to more than one agency, and involves (1) threats to the United States, its people, property, or interests, (2) the development, proliferation, or use of weapons of mass destruction, or (3) any other matter bearing on US national or homeland security. (JP 1-02)

**near real time**—Pertaining to the timeliness of data or information which has been delayed by the time required for electronic communication and automatic data processing. This implies that there are no significant delays. Also called **NRT**. (AAP-06)

**operational control**—Command authority that may be exercised by commanders at any echelon at or below the level of combatant command. Operational control is inherent in combatant command (command authority) and may be delegated within the command. Operational control is the authority to perform those functions of command over subordinate forces involving organizing and employing commands and forces, assigning tasks, designating objectives, and giving authoritative direction necessary to accomplish the mission. Operational control includes authoritative direction over all aspects of military operations and joint training necessary to accomplish missions assigned to the command. Operational control should be exercised through the commanders of subordinate organizations. Normally this authority is exercised through subordinate joint force commanders and Service and/or functional component commanders. Operational control normally provides full authority to organize commands and forces and to employ those forces as the commander in operational control considers necessary to accomplish assigned missions; it does not, in and of itself, include authoritative direction for logistics or matters of administration, discipline, internal organization, or unit training. Also called **OPCON**. (JP 1-02)

**order of battle**—The identification, strength, command structure, and disposition of the personnel, units, and equipment of any military force. Also called **OOB**. (JP 1-02)

**priority intelligence requirement**—(See JP1-02 for core definition. Marine Corps amplification follows.) An intelligence requirement associated with a decision that will critically affect the overall success of the command's mission. Also called **PIR**. (MCRP 5-12C)

**production management**—Encompasses determining the scope, content, and format of each intelligence product; developing a plan and schedule for the development of each product; assigning priorities among the various production requirements; allocating processing, exploitation, and production resources; and integrating production efforts with intelligence collection and dissemination. (MCRP 5-12C)

**radar imagery**—Imagery produced by recording radar waves reflected from a given target surface. (JP 1-02)

**reachback**—(See JP1-02 for core definition. Marine Corps amplification follows.) The ability to exploit resources, capabilities, expertise, etc., not physically located in the theater or a joint operations area, when established. (MCRP 5-12C)

**rear area**—That area extending forward from a command's rear boundary to the rear of the area assigned to the command's subordinate units. This area is provided primarily for the performance of combat service support functions. (MCRP 5-12C)

**security**—1. Measures taken by a military unit, activity, or installation to protect itself against all acts designed to, or which may, impair its effectiveness. 2. A condition that results from the establishment and maintenance of protective measures that ensure a state of inviolability from hostile acts or influences. 3. With respect to classified matter, the condition that prevents unauthorized persons from having access to official information that is safeguarded in the interests of national security. (JP 1-02)

**sensitive compartmented information**—All information and materials bearing special community controls indicating restricted handling within present and future community intelligence collection programs and their end products for which community systems of compartmentation have been or will be formally established. (These controls are over and above the provisions of DOD 5200.1-R, Information Security Program Regulation.) Also called **SCI**. (JP 1-02)

**sensor data**—Data derived from sensors whose primary mission is surveillance or target acquisition, such as air surveillance radars, counterbattery radars, and remote ground sensors. (MCRP 5-12C)

**signals intelligence**—1. A category of intelligence comprising either individually or in combination all communications intelligence, electronic intelligence, and foreign instrumentation signals intelligence, however transmitted. 2. Intelligence derived from communications, electronic, and foreign instrumentation signals. Also called **SIGINT**. (JP 1-02)

**situational awareness**— Knowledge and understanding of the current situation that promotes timely, relevant, and accurate assessment of friendly, enemy, and other operations within the battlespace in order to facilitate decisionmaking. An informational perspective and skill that foster an ability to determine quickly the context and relevance of events that are unfolding. Also called **SA**. (MCRP 5-12C)

**source**—1. A person, thing, or activity from which information is obtained. 2. In clandestine activities, a person (agent), normally a foreign national, in the employ of an intelligence activity for intelligence purposes. 3. In interrogation activities, any person who furnishes information, either with or without the knowledge that the information is being used for intelligence purposes. (JP 1-02)

**special operations**—Operations requiring unique modes of employment, tactical techniques, equipment and training often conducted in hostile, denied, or politically sensitive environments and characterized by one or more of the following: time sensitive, clandestine, low visibility, conducted with and/or through indigenous forces, requiring regional expertise, and/or a high degree of risk. Also called **SO**. (JP 1-02)

**surveillance**—(See JP1-02 for core definition. Marine Corps amplification follows.) The systematic visual or aural observation of an enemy force or named area of interest or an area and the activities in it to collect intelligence required to confirm or deny adversary courses of action or identify adversary critical vulnerabilities and limitations. (MCRP 5-12C)

**sustained operations ashore**—The employment of Marine Corps forces on land for an extended duration. It can occur with or without sustainment from the sea. Also called **SOA**. (MCRP 5-12C)

**synthetic aperture radar**—A radar in which a synthetically long apparent or effective aperture is constructed by integrating multiple returns from the same ground cell, taking advantage of the Doppler effect to produce a phase history film or tape that may be optically or digitally

processed to reproduce an image. Also called **SAR** and known as **radar, synthetic aperture**. (MIL-HDBK-850)

**tactical intelligence**—(See JP1-02 for core definition. Marine Corps amplification follows.) Intelligence concerned primarily with the location, capabilities, and possible intentions of enemy units on the battlefield and the tactical aspects of terrain and weather within the battlespace. (MCRP 5-12C)

**target**—1. An entity or object considered for possible engagement or other action. 2. In intelligence usage, a country, area, installation, agency, or person against which intelligence operations are directed. 3. An area designated and numbered for future firing. 4. In gunfire support usage, an impact burst that hits the target. (JP 1-02)

**target intelligence**—Intelligence that portrays and locates the components of a target or target complex and indicates its vulnerability and relative importance. (JP 1-02)

**technical control**—The performance of specialized/professional service or the exercise of professional guidance/direction through the establishment of policies and procedures. Also called **TECHON**. (MCRP 5-12C)

**validation**—1. A process associated with the collection and production of intelligence that confirms that an intelligence collection or production requirement is sufficiently important to justify the dedication of intelligence resources, does not duplicate an existing requirement, and has not been previously satisfied. 3. In computer modeling and simulation, the process of determining the degree to which a model or simulation is an accurate representation of the real world from the perspective of the intended uses of the model or simulation. (JP 1-02) (Parts 1 and 3 of a 4-part definition.)

**warfighting functions**—The six mutually supporting military activities integrated in the conduct of all military operations. The six warfighting functions are command and control, fires, force protection, intelligence, logistics, and maneuver.

# REFERENCES AND RELATED PUBLICATIONS

## Executive Orders

12333	United States Intelligence Activities
12951	Release of Imagery Acquired by Space-Based National Intelligence Reconnaissance Systems
12968	Access to Classified Information
13462	President's Intelligence Advisory Board and Intelligence Oversight Board
13526	Classified National Security Information

## Federal Publications

United States Code, Title 10, *Armed Forces*

## Department of Defense Issuances

### Department of Defense Directive (DODD)

5240.01 DOD Intelligence Activities

### Department of Defense Instruction (DODI)

5040.02 Visual Information (VI)

### Department of Defense Manuals (DODMs)

5105.21, vol. 1 Sensitive Compartmented Information (SCI) Administrative Security Manual: Administration of Information and Information Systems Security

5200.01, vols. 1–4 DoD Information Security Program: Overview, Classification, and Declassification

### Defense Intelligence Agency Manuals (DIAMs)

50-4 Department of Defense Intelligence Information System (DODIIS) Information Systems Security (INFOSEC) Program

57-5 DOD Exploitation of Multisensor Imagery

### Defense Intelligence Agency Publications (DIAP)

5210.002-M Standard Coding Systems Functional Classification Handbook (U)



## **Chairman of the Joint Chiefs of Staff Publications**

### Chairman of the Joint Chiefs of Staff Instruction (CJCSI)

3160.01	No-Strike and the Collateral Damage Estimation Methodology (U)
3370.01	Target Development Standards (U//FOUO)
3505.01	Target Coordinate Mensuration Certification and Program Accreditation

### Chairman of the Joint Chiefs of Staff Manual (CJCSM)

3122.01_	Joint Operation Planning and Execution System (JOPES) Volume 1 (Planning Policies and Procedures)
----------	---

## **Joint Publications (JPs)**

1-02	Department of Defense Dictionary of Military and Associated Terms
2-0	Joint Intelligence
2-01	Joint and National Intelligence Support to Military Operations
2-01.3	Joint Intelligence Preparation of the Operational Environment
2-03	Geospatial Intelligence in Joint Operations
3-02	Amphibious Operations
3-13.1	Electronic Warfare
3-13.3	Operations Security
3-32	Command and Control for Joint Maritime Operations
3-59	Meteorological and Oceanographic Operations
3-60	Joint Targeting
5-0	Joint Operation Planning
6-0	Joint Communications System

## **Secretary of the Navy Manual (SECNAV)**

Department of the Navy Foreign Disclosure Manual

## **North Atlantic Treaty Organization (NATO) Standardization Agreement (STANAG)**

3277	Air Reconnaissance Request/Task Form
------	--------------------------------------

## Allied Administrative Publications

AAP-6 North Atlantic Treaty Organization (NATO) Glossary of Terms and Definitions

## Army Publication

### Field Manual Interim (FMI)

2-01 Intelligence, Surveillance, and Reconnaissance (ISR) Synchronization

## Marine Corps Publications

### Marine Corps Warfighting Publications (MCWPs)

2-2 MAGTF Intelligence Collection  
2-3 MAGTF Intelligence Production and Analysis  
2-4 Marine Air-Ground Task Force Intelligence Dissemination  
2-26 Geographic Intelligence  
3-25 Control of Aircraft and Missiles  
5-1 Marine Corps Planning Process

### Marine Corps Reference Publications (MCRPs)

5-12C Marine Corps Supplement to the Department of Defense Dictionary of Military and Associated Terms

### Marine Corps Order (MCO)

3500.32 Intelligence Training and Readiness Manual  
P4790.2C MIMMS Field Procedures Manual  
5510.20B Disclosure of Military Information to Foreign Governments and Interests

### Marine Corps Intelligence Agency Publication (MCIA-)

1540-0003-03 Generic Intelligence Requirements Handbook (GIRH)

## Director of Central Intelligence Directives (DCIDs)

1/8 Management of National Imagery, Imagery Intelligence, Geospatial Activities and Related Information

6/1 Security Policy for SCI and Security Policy Manual

## Intelligence Community Directives (ICDs)

1	Policy Directive for Intelligence Community Leadership
104	Budgeting for Intelligence Programs
113	Functional Managers
204	Roles and Responsibilities for the National Intelligence Priorities Framework
503	Intelligence Community Information Technology Systems Security, Risk Management, Certification and Accreditation
700	Protection of National Intelligence
704	Personnel Security Standards and Procedures Governing Eligibility for Access to Sensitive Compartmented Information and Other Controlled Access Program Information
705	Sensitive Compartmented Information Facilities
710	Classification and Control Markings System

## National Systems for Geospatial-Intelligence Documents

### NSG Directives (NSGDs)

FM 1100	(U) Roles and Responsibilities of the Department of Defense (DOD) Geospatial Intelligence (GEOINT) Manager and the Intelligence Community (IC) Functional Manager for GEOINT
---------	--

### NSG Instructions (NSGIs)

FM 1101	(U) The National System for Geospatial-Intelligence (NSG) Policy Program
FM 1103	Governance Structure for Geospatial Intelligence (GEOINT) Functional Management
ST 8101	(U) GEOINT Data, Products, and Sources Storage Management (S//NOFORN[not releasable to foreign nationals])

### NSG Manuals (NSGM)

CS 9300.02	National System for Geospatial Intelligence (NSG), (U) Marking and Dissemination Guidance (S//REL TO [release to] USA, FVEY)
CS 9300.03	National System for GEOINT–Geospatial Intelligence Classification Guide (TS//SCI//NOFORN)
CS 9300.04	National System for GEOINT–Geospatial Intelligence Classification Guide For Common Wealth Partners (TS//SCI//REL TO USA, AUS, CAN, GBR, NZL)
FA 1806	Domestic Imagery (U//FOUO)

## Military Standards (MIL-STD-)

188-161_	Interoperability and Performance Standards for Digital Facsimile Equipment
188-196	Department of Defense Interface Standard: Bi-Level Image Compression for the National Imagery Transmission Format Standard
188-198A	Joint Photographic Experts Group (JPEG) Image Compression for the National Imagery Transmission Format
188-199	Vector Quantization Decompression for the National Imagery Transmission Format
2500C	National Imagery Transmission Format (Version 2.1) for the National Imagery Transmission Format Standard

## Military Handbooks (MIL-HDBK-)

850	Glossary of Mapping, Charting, and Geodetic Terms
-----	---

## Miscellaneous

- Controlled Access Program Coordination Office (CAPCO), Authorized Classification and Control Markings Register (Located on JWICS)
- Geospatial Integrated Digital Environment (GIDE) via Defense Intelligence Agency (Located on JWICS)
- Geospatial Intelligence Classification Guide (Located on JWICS)
- Imagery System Overview (IMSO) (October 2008) (Located on JWICS)
- Joint Tactical Exploitation of National Systems (JTENS) Manual (Located on JWICS)
- Modernized Integrated Database (MIDB) via Gemini Intelligence Portal (Located on JWICS)
- National Geospatial-Intelligence Agency Imagery Policy Series [IPS] [section 9, part B], Domestic Imagery [IPS-001/98-S9A]
- National Geospatial-Intelligence Agency STDI-0001V1.3/CN2 National Support Data Extensions (SDE) (Version 1.3/CN2) for the National Imagery Transmission Format (NITF)
- National Geospatial-Intelligence Agency STDI-006, National Imagery Transmission Format (NITF) Version 2.1 Commercial Dataset Requirements Document (NCDRD), 18 February 2010.
- National Imagery System User's Guide (NIMSUG) (May 2008)
- National Imagery Interpretability Rating Scale (NIIRS)
- National Imagery and Mapping Agency Imagery Policy Series (Sections 1–9)

International Telecommunications Union-Radiocommunication Sector BT.500-12,  
Methodology for the Subjective Assessment of the Quality of Television Pictures

Motion Imagery Standards Board, MISB RP 0901.1, Recommended Practice,  
Video-National Imagery Interpretability Rating Scale

Motion Imagery Standards Profile, MISP version 6.4

## To Our Readers

**Changes:** Readers of this publication are encouraged to submit suggestions and changes through the Universal Need Statement (UNS) process. The UNS submission process is delineated in Marine Corps Order 3900.15, *Marine Corps Expeditionary Force Development System*, which can be obtained from the on-line Marine Corps Publications Electronic Library:

<http://www.marines.mil/News/Publications/ELECTRONICLIBRARY.aspx>.

The UNS recommendation should include the following information:

- Location of change
  - Publication number and title
  - Current page number
  - Paragraph number (if applicable)
  - Line number
  - Figure or table number (if applicable)
- Nature of change
  - Addition/deletion of text
  - Proposed new text

**Additional copies:** If this publication is not an electronic only distribution, a printed copy may be obtained from Marine Corps Logistics Base, Albany, GA 31704-5001, by following the instructions in MCBul 5600, *Marine Corps Doctrinal Publications Status*. An electronic copy may be obtained from the United States Marine Corps Doctrine web page:

<https://www.doctrine.usmc.mil>.

**Unless otherwise stated, whenever the masculine gender is used,  
both men and women are included.**