

MCRP 3-20F.2
(Formerly MCWP 3-25.4)

Marine Tactical Air Command Center Handbook



US Marine Corps

DISTRIBUTION STATEMENT A: Approved for public release; distribution is unlimited.

PCN 144 000252 00

CD&I (C 116)

2 May 2016

ERRATUM

to

MCWP 3-25.4

MARINE TACTICAL AIR COMMAND CENTER HANDBOOK

1. Change all instances of MCWP 3-25.4, *Marine Tactical Air Command Center Handbook*, to MCRP 3-20F.2, *Marine Tactical Air Command Center Handbook*.
2. Change PCN 143 000056 00 to PCN 144 000252 00.
3. File this transmittal sheet in the front of this publication.

PCN 144 000252 80

DEPARTMENT OF THE NAVY
Headquarters United States Marine Corps
Washington, DC 20380-1775

6 May 2008

FOREWORD

The Marine air command and control system (MACCS) provides the Marine aviation combat element (ACE) commander with the means to exercise command and control of organic and nonorganic aviation assets necessary to support Marine air-ground task force (MAGTF) operations. Marine Corps Warfighting Publication (MCWP) 3-25, *Control of Aircraft and Missiles*, addresses basic Marine Corps air command and control philosophy. MCWP 3-25.3, *Marine Air Command and Control System Handbook*, addresses basic planning considerations for MACCS interoperability, employment, and operations among MACCS and joint Service agencies. MCWP 3-25.4, *Marine Tactical Air Command Center Handbook*, complements and expands on the information in MCWPs 3-25 and 3-25.3 by focusing on the details of Marine tactical air command center (TACC) operations and the role the Marine TACC plays in integrated MAGTF, joint, and coalition operations.

This publication presents the baseline Marine TACC that would be employed by a single-wing ACE supporting a standing Marine expeditionary force in the conduct of sustained operations ashore. Larger- and smaller-scale operations can be supported by adding to or subtracting from the baseline configuration.

Designed for MAGTF, naval expeditionary force and joint force commanders and staffs, as well as all MAGTF officers and staff noncommissioned officers, MCWP 3-25.4 highlights Marine TACC—

- Organization and manning.
- Equipment.
- Planning considerations.
- Operational fundamentals.
- Employment options.
- Training fundamentals.

By investigating these areas, MCWP 3-25.4 provides the requisite information needed by commanders and their staffs to understand and evaluate the operational principles and capabilities of the Marine TACC.

This publication supersedes MCWP 3-25.4, *Marine Tactical Air Command Center Handbook*, dated 21 September 1998.

Reviewed and approved this date.

BY DIRECTION OF THE COMMANDANT OF THE MARINE CORPS

A handwritten signature in black ink, appearing to read 'James F. Amos', with a long horizontal stroke extending to the right.

JAMES F. AMOS

Lieutenant General, U.S. Marine Corps

Deputy Commandant for Combat Development and Integration

Publication Control Number: 143 000056 00

DISTRIBUTION STATEMENT A: Approved for public release; distribution is unlimited.

Table of Contents

Chapter 1. Fundamentals

Mission and Functions	1-2
MAGTF Single-Battle Concept	1-4
Marine Expeditionary Force–Aviation Combat Element Staff Alignment	1-5
Centralized Command and Decentralized Control	1-7
Modularity and Scalability	1-8

Chapter 2. Organization and Manning

Section I. Future Plans	2-5
Mission and Functions	2-6
Billet Descriptions	2-7
Future Plans Officer	2-7
Senior Planner	2-7
Airspace Control Measures Planner	2-8
Air Defense Planner	2-9
Assault Support Planner	2-10
Strike Support Planner	2-10
Functional Staff Planners	2-11
Senior MAGTF Planner	2-15
MAGTF Planners	2-16
Layout	2-17
Section II. Future Operations	2-17
Organization and Manning	2-17
Concept of Organization	2-19
Mission and Functions	2-19
Billet Descriptions	2-20
Future Operations Officer	2-20
Assistant Future Operations Officer	2-21
Operations Administration Section	2-22

MCWP 3-25.4

Ground Watch Section.....	2-22
Intelligence Watch Section.....	2-23
ATO Development Section.....	2-24
Orders Development Section.....	2-28
Layout.....	2-29
Section III. Current Operations	2-30
Organization and Manning.....	2-30
Concept of Organization.....	2-30
Mission and Functions.....	2-34
Billet Descriptions.....	2-34
Tactical Air Commander.....	2-34
Current Operations Officer.....	2-35
Assistant Current Operations Officer.....	2-35
Operations Administration Section.....	2-36
Systems Control Section.....	2-36
Ground Watch Section.....	2-38
Intelligence Watch Section.....	2-39
ACE Watch Section.....	2-40
Current Operations Watch Crew.....	2-43
Layout.....	2-55
Section IV. Air Combat Intelligence	2-57
Organization and Manning.....	2-57
Concept of Organization.....	2-57
Mission and Functions.....	2-60
Billet Descriptions.....	2-61
ACI Officer.....	2-61
Assistant ACI Officer.....	2-63
ACI Chief.....	2-63
ACI Operations Administration Section.....	2-63
Intelligence Analysis Section.....	2-64
Signals Intelligence Section.....	2-67
SIGINT Officer.....	2-67
Collection Section.....	2-70

Target Intelligence Section.....	2-71
Intelligence Plans Section	2-76
Requirements and Dissemination Section.....	2-77
Intelligence Systems Section.....	2-78
Weather Section	2-78
Layout	2-80

Chapter 3. System Description

Theater Battle Management Core Systems	3-2
CAOC Central.....	3-2
TBMCS Role in the Marine TACC.....	3-3
Applications and the ATO Cycle	3-4
Communications Data Link System	3-5
C2PC	3-7
AN/MRQ-12	3-7
Commander's Tactical Terminal	3-9
Shelter Suite	3-10
Base-X Shelter.....	3-12
3-1 ISO Shelter.....	3-12
Modular Extendable Rigid Wall Shelter	3-14
Marine Corps Expeditionary Shelter System	3-15
Nonorganic Shelter Options	3-17
Power Distribution System.....	3-18
Cable Sets, Reels, and Pallets	3-18
Ancillary Equipment.....	3-19
Power Equipment	3-19
Environmental Control Units	3-19
System Limitations	3-19
Data Link Dependency.....	3-19
Vulnerability to Electronic Detection	3-19
Lack of Mobility.....	3-20

MCWP 3-25.4

Equipment Upgrades and Replacements	3-20
Advanced Field Artillery Tactical Data System	3-20
Tactical Electronic Reconnaissance Processing and Evaluation System	3-21
Common Aviation Command and Control System	3-21

Chapter 4. Planning

Long-Term Planning	4-4
Near-Term Planning	4-5
Marine Corps Planning Process	4-6
Aviation Planning Products	4-9
Initial Estimate of Aviation Requirements	4-9
Aviation Estimate of Supportability	4-10
Detailed Estimate of Aviation Support Requirements	4-11
Aviation Concept of Operations	4-11
Preparing Aviation Documents.....	4-12
ATO Cycle	4-12
Target Planning Cycle	4-14
Intelligence Planning Cycle.....	4-17
Preliminary Intelligence Estimate.....	4-17
Intelligence Estimate	4-18
Other Planning Considerations.....	4-19
Aviation Command, Control, and Communications Planning	4-19
Assault Support Planning	4-19

Chapter 5. Operations

Employment	5-1
Marine TACC Site.....	5-1
Tactical Air Direction Center Site	5-2
Echelon Site	5-3
Austere Marine TACC Site	5-3

MAGTF Operations	5-4
Marine Expeditionary Force.....	5-4
Marine Expeditionary Unit.....	5-5
Marine Expeditionary Brigade	5-5
Amphibious Operations	5-5
Tactical Air Direction Center	5-6
Tactical Air Command Center (Ashore).....	5-6
Phasing Control Ashore	5-6
Joint or Multinational Operations	5-8
Joint or Multinational Planning.....	5-8
Liaisons	5-8
Interoperability	5-9
Combat Operations	5-10
Succession of Command and Control.....	5-11
Marine TACC Siting Considerations.....	5-12
Mission Requirements.....	5-12
Suitable Terrain	5-12
Terrain Masking	5-12
Proximity to Key Assets and/or Nodes	5-13
Communications Engineering.....	5-13
Physical Security	5-14
Accessibility	5-14
Dispersion.....	5-15
Cover and Concealment.....	5-15
Occupation Process	5-15
Site Security Considerations	5-16
Barriers.....	5-16
Guard Coordination.....	5-16
Security Procedures.....	5-17
Site Hardening Considerations.....	5-17
Revetment or Hardening of Generators	5-17
Hardening of Operating Shelters.....	5-18
Number of Bunkers	5-18

Appendices

A. Manning Requirements for Baseline Marine TACCA-1

B. Augments, Liaisons, and Additional Marine
TACC Positions.....B-1

C. Training.....C-1

D. Marine TACC Communications NetsD-1

E. GlossaryE-1

F. ReferencesF-1

Chapter 1

Fundamentals

The aviation combat element (ACE) commander is normally the Marine air-ground task force (MAGTF) tactical air commander (TAC) and advises the MAGTF commander on the most effective employment of ACE assets. The ACE battlestaff assists the ACE commander in executing duties by providing specialized expertise and advice.

The ACE battlestaff (fig. 1-1) consists of the chief of staff, the principal staff officers (G-1, G-2, G-3, G-4, G-6, and aviation logistics division [ALD] representative), and special staff officers (e.g., staff judge advocate, surgeon, chaplain) required by the situation or the ACE commander.

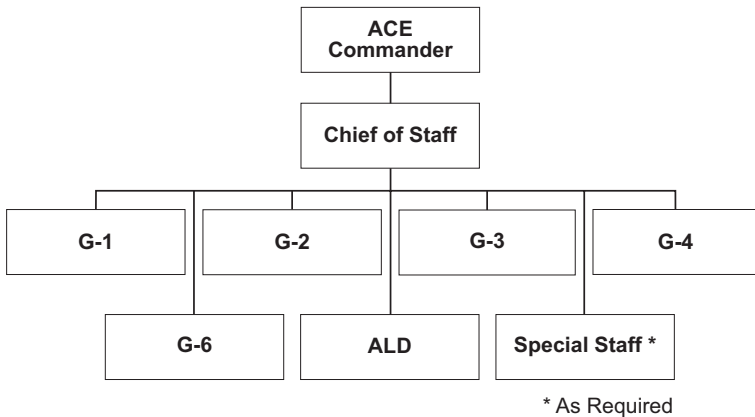

Figure 1-1. ACE Battlestaff.

MCWP 3-25.4

The chief of staff is the principal assistant and advisor to the ACE commander. The principal staff officers provide functional expertise and recommendations during deliberations. The principal staff officers facilitate the ACE's capability to plan and conduct missions across the range of military operations by directing the activities of their respective staff sections based on a shared understanding of the ACE commander's intent.

The ACE commander convenes the battlestaff, while the chief of staff coordinates and directs the battlestaff's efforts. The battlestaff meets regularly with the ACE commander to review ongoing operations and assists in forming the ACE's concept of operations for planned activities.

Mission and Functions

The ACE commander exercises air operations authority through the Marine air command and control system (MACCS). The Marine tactical air command center (TACC) is the senior MACCS agency. It is the operational wing command post from which the ACE commander and his staff plan, supervise, coordinate, and execute MAGTF air operations (this includes the planning and execution of all air tasking orders [ATOs] and the execution of the current ACE operation order [OPORD] or fragmentary order [FRAGO]). It integrates the six functions of Marine aviation with the MAGTF command element (CE) through linkage with the MAGTF combat operations center and the force fires coordination center (FFCC). The Marine TACC provides functional interface for employment of MAGTF aviation in joint and coalition operations. It is referred to as the Marine TACC to avoid confusion with the Navy's tactical air control center (TACC). The role of the Marine air control group (MACG) and the Marine TACC must be

established according to the operational employment of the MACCS and associated joint assets operating within the assigned MAGTF area of operations.

As the focal point for the planning and execution of MAGTF air operations, the following functions will be performed from the Marine TACC:

- Manage the execution of the current ACE OPORD or FRAGO.
- Manage all aircraft and surface-to-air weapons in the MAGTF's area of operations.
- Monitor the status of MAGTF air assets, ground based air defense assets, and ground and airborne sensors in support of air operations.
- Serve as the operational point of contact between the MACCS and external air control agencies.
- Coordinate the operations of subordinate MACCS agencies.
- Develop, issue, and integrate MAGTF air operations plans and orders including MAGTF ATOs, airspace control orders (ACOs), air defense plans (ADPs), and airspace control plans (ACPs).
- Recommend apportionment of MAGTF air assets to the MAGTF commander.
- Provide centralized direction for the allocation and tasking of MAGTF air assets.
- Direct execution of MAGTF air operations.
- Coordinate MAGTF air operations with other theater air operations.
- Establish all air defense control measures in the MAGTF's area of operations including air defense warning conditions and weapons control statuses.

- Evaluate the results of MAGTF air operations.
- Prescribe succession of command and control (C2) responsibilities within the MACCS to compensate for any serious degradation within the C2 system.

MAGTF Single-Battle Concept

The Marine TACC is organized as a fully integrated facility to promote the intra- and inter-staff coordination necessary for responsive and synchronized MAGTF air operations. An organizational structure is required to meet the critical planning and executive decision points in support of the MAGTF's single-battle concept.

Through top down guidance (mission and intent), the MAGTF commander focuses the efforts of all MAGTF assets in complementary operations toward a common objective as shown in figure 1-2.

This single-battle concept is in keeping with the warfighting principles of unity of command and unity of effort. It exploits the combined-arms nature of MAGTF operations in concert with the principles of maneuver warfare to present the enemy with a dilemma: movement of forces to counter MAGTF maneuver will expose them to MAGTF fires; whereas lack of movement for fear of losses to MAGTF fires will prevent them from countering MAGTF maneuver.

At each subordinate echelon, planning and execution must support the MAGTF commander's intent and concept of operations. This fundamental tenet of the MAGTF single battle drives the requirement for the Marine TACC to be organized to ensure unity of effort in its internal planning and execution processes as well as to meet the battle rhythm of the MAGTF commander.

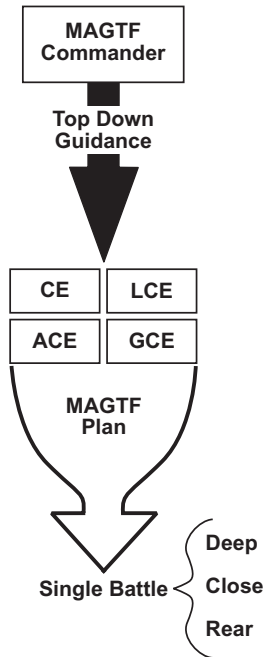

Figure 1-2. MAGTF Single-Battle Concept.

Marine Expeditionary Force–Aviation Combat Element Staff Alignment

The Marine TACC enables the ACE staff to align functionally and organizationally with the Marine expeditionary force (MEF)

MCWP 3-25.4

staff (see fig. 1-3). This facilitates inter-staff coordination, which is critical for effective planning and execution of MAGTF air operations. This inter-staff coordination allows the ACE to successfully accomplish the time-driven tasks necessitated by the air tasking cycle while simultaneously satisfying the MEF's requirement to plan and execute event-driven operations.

Another key organizational tenet of the Marine TACC is integrated staff planning. The principal staff sections are represented during all phases of the operational planning process. This allows the ACE commander to develop a vision and concept of operations based on a balanced appraisal of each warfighting function.

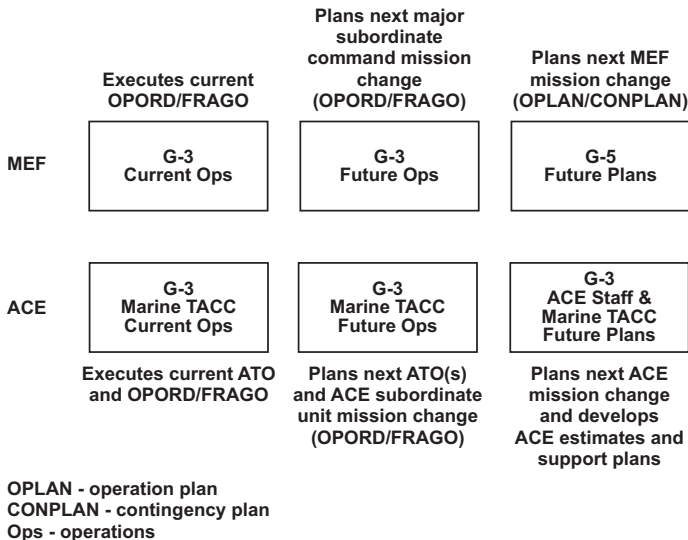

Figure 1-3. MEF-ACE Staff Alignment.

Centralized Command and Decentralized Control

The Marine TACC uses centralized command to establish priorities and ensure unity of effort of MAGTF air operations. The ACE's aviation assets are finite, and the air groups and squadrons will likely be located at several bases. Centralized planning and direction are essential for coordinating the efforts of all the ACE's assets. Additionally, it allows for the optimum selection and coordination of units in time, space, and purpose to best meet the MAGTF commander's priorities. The Marine TACC assumes several squadron or group planning functions including weaponing and force application decisions. With the codification of the joint force air component commander's (JFACC's) concept into joint doctrine, the ACE has altered its procedures to meet the established joint air tasking timeline. Squadron or group staffs are not manned nor do they have the requisite operational and intelligence information to conduct the level of synchronized, detailed planning necessary within the mandated joint timelines.

While command is centralized for planning and execution within the Marine TACC, control is decentralized for specific aviation functions to subordinate MACCS agencies to generate the tempo of operations required to cope with the uncertainty of combat operations. For example, the direct air support center (DASC) will control and allot aviation assets apportioned to the close fight, and the tactical air operations center (TAOC) will control assets apportioned to active air defense. The major exception to this tenet is the control of deep air support (DAS) missions forward of the fire support coordination line (FSCL) within the MAGTF area of operations.

MCWP 3-25.4

Because of the focus of the conduits of operational and intelligence information within the Marine TACC, it is the MACCS agency most capable of synchronizing DAS missions beyond the FSCL with other MAGTF lethal and nonlethal assets.

Marine TACC current operations will provide real-time air direction of aircraft prosecuting the MAGTF deep operations shaping campaign. This excludes air traffic control and ground control intercept operations. Air direction in the deep battle may be accomplished through the Marine liaison officer (LNO) aboard an airborne platform (i.e., E-2, E-3, or E-8) or a tactical air coordinator (airborne) who will function as an extension of the Marine TACC (an expansion of its current role as an extension of the DASC), in concert with an airborne radio relay if required.

Modularity and Scalability

The Marine TACC's organizational structure is flexible to meet the requirements of the ACE commander across the range of military operations. All organizations within the Marine TACC employ a cellular structure that is modular and scalable. Modularity refers to the design of the cells as independent, interoperable sections that are arranged and, as required, rearranged to support one or several operations. Modularity allows the ACE commander to tailor the Marine TACC by adding or subtracting cells (scalability), or parts or size of cells, as the mission requires. For example, when performing foreign humanitarian assistance operations, the deep and close battle cells would probably not be used. The airspace coordination cell may be the only current operations cell activated. While other cells may not be activated, some of their functions may be

moved to other cells. In this example, the rescue coordination cell (RCC) may not be formed; however, some of its normal functions may be taken on by the airspace coordination cell. Interoperability is inherent in the design of the facility.

The baseline Marine TACC organization presented in this handbook is designed to support a MEF. The ACE in support of the MEF would possess the full spectrum of Marine aviation capabilities. The Marine TACC would be necessarily robust, possessing all available functionality to plan and execute MAGTF air operations to influence the deep battle, support the close battle, and protect the rear area.

This baseline organization is capable of expansion or contraction based on the size and scope of the operation and the Marine TACC's intended role (see fig. 1-4 on page 1-10). The factors that should be considered when determining the size of the Marine TACC and its organizational structure include: mission, force composition, concept of operations, threat, area of operations, unity of command and control, and expected duration. As these factors change, the size and internal organization of the Marine TACC would be tailored to meet the requirement. A larger operation may require additional augmentees to bolster each cell.

The Marine TACC structure also allows flexibility in scaling for the ACE commander to assume the responsibilities of an interim or enabling JFACC. Liaison elements from other air capable components would be required to assist and coordinate the planning and execution of air operations. Another factor to consider is whether the ACE commander is also assigned the responsibilities of area air defense commander (AADC) and airspace control authority (ACA) possibly necessitating additional external augmentation.

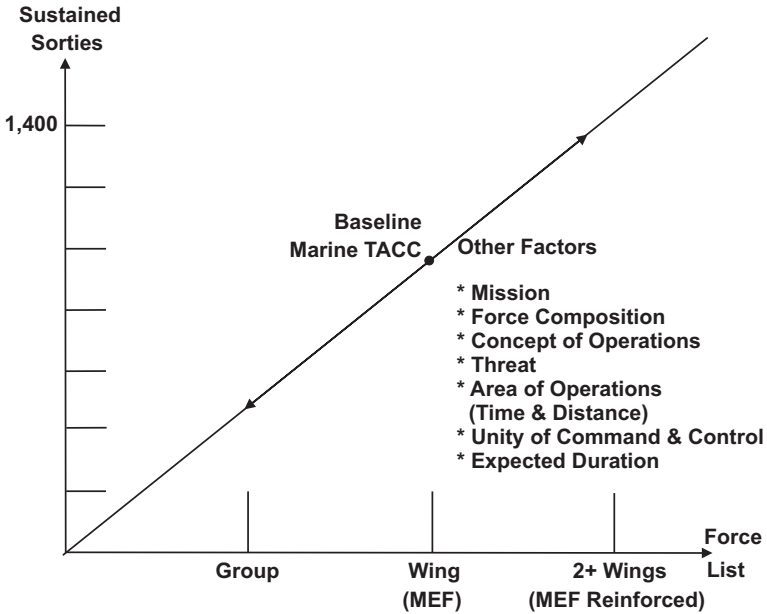

Figure 1-4. Marine TACC Organization Scalability.

Chapter 2

Organization and Manning

The Marine TACC consists of four mutually supporting, cross-functional operational organizations supported by a centralized intelligence organization. Its organizations and their relationship to the ACE battlestaff are shown in figure 2-1, on page 2-2. The Marine TACC does not provide facilities for all ACE staff functions. It provides a facility from which the ACE commander and staff plan and execute MAGTF aviation and aviation support operations. Marine TACC organizations are—

- Future plans.
- Future operations.
- Current operations.
- Air combat intelligence (ACI).

Future plans conducts aviation and aviation support planning for the next MEF mission. Future operations develops future ATOs and prepares OPORDs or FRAGOs for the next ACE mission. Current operations executes the daily ATO and assesses the ATO's effectiveness.

ACI is embedded within the Marine TACC. Timely, tailored, and fused intelligence is integral to the functioning of future plans, future operations, and current operations. ACI is the focus of all aviation intelligence activities supporting the ACE. It produces and disseminates aviation-specific, all-source intelligence, to include assessments of enemy capabilities and vulnerabilities, target analysis, battle damage assessment (BDA), and the current status and priority of assigned targets to assist in execution day changes.

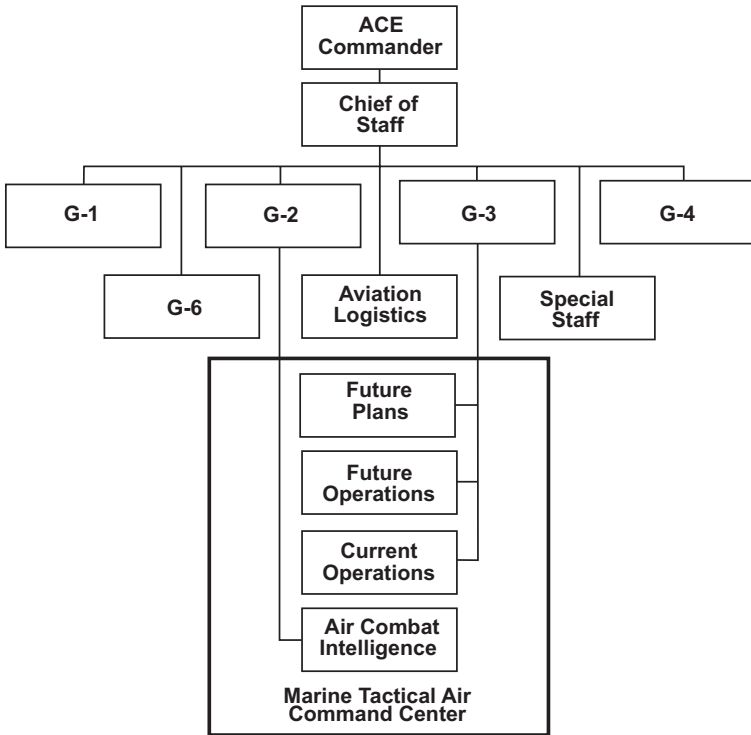

Figure 2-1. Marine TACC Organizations and Command Relationships to the ACE Battlestaff.

The principal staff sections (e.g., personnel, intelligence, logistics, communications) provide tailored staff support to the Marine TACC, including appropriate full-time representation (via a matrix style structure) as required (see fig. 2-2). This cross-functional representation within future plans, future operations, and

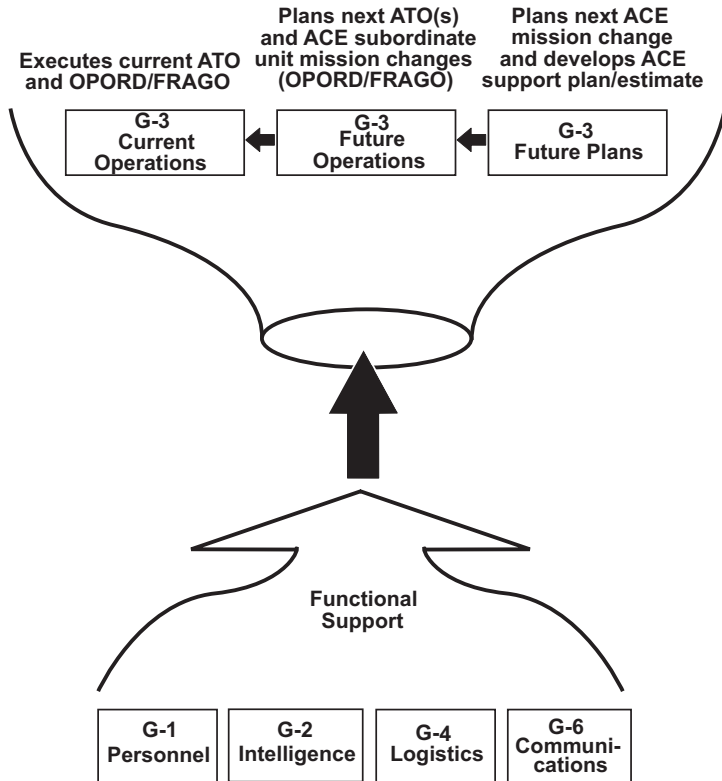

Figure 2-2. ACE Staff Organization.

current operations facilitates a fully integrated plan from conception to execution.

The ACE G-3 is the direct representative of the ACE commander in the Marine TACC. The ACE G-3 is responsible for the execution of the current ACE OPORD or FRAGO and the overall functioning of future plans, future operations, and current operations

in the planning and execution of all ATOs. The ACE G-2 has staff cognizance over all ACE intelligence activities including ACI and the intelligence watch crews in future operations and current operations. The other principal staff officers maintain cognizance over their respective sections including their representatives within each operational cell and provide support from a common functional perspective.

The Marine TACC must be staffed adequately to fulfill all of the ACE commander's responsibilities, as well as permit continuous operations. The nucleus of required expertise to operate and maintain the Marine TACC is provided by the ACE headquarters staff, the MACG, and selected augments from subordinate aviation units. Additional augmentees may be required based on the composition of the ACE and the scope of its mission. Liaison personnel from other components of the MAGTF, other Services, and allied nations may also augment the Marine TACC to facilitate coordination in joint and multinational operations. In addition, the ACE commander should be prepared to provide liaison representation to the MEF and other Services to ensure proper coordination and integration within the MAGTF. See appendices A and B for manning requirements for a baseline Marine TACC and augmentees and liaison personnel. See appendix C for Marine TACC training requirements for Marines and augments.

Section I. Future Plans

Future plans consists of a number of aviation personnel tasked to provide estimates of supportability and support plans for the next MAGTF mission. Cross-functional staff representation will expand future operations to provide expertise for planning functions. This integrated planning effort provides credible, expedient, and synergistically developed input to the planning process.

Future plans is comprised of personnel from the ACE staff built around a nucleus of experienced aviation planners. Functional staff representation is provided, as required, to facilitate planning. Future plans is structured around a single watch section. The future plans officer may need to shift personnel to meet planning, decision, execution, and assessment (PDE&A) timelines for the delivery of required support planning products. Future plans is organized as shown in figure 2-3.

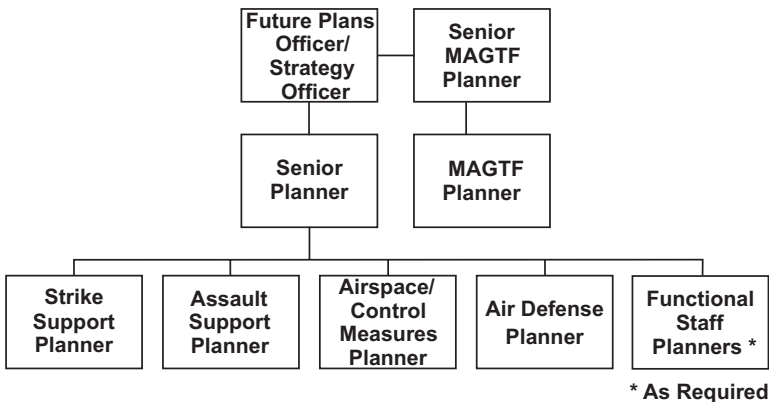

Figure 2-3. Future Plans.

Mission and Functions

Future plans is responsible to the ACE G-3 for aviation planning in support of the next MEF mission. Future plans will—

- Maintain close and continuous liaison with MAGTF future plans.
- Conduct deliberate planning for MAGTF operation plans (OPLANs) and follow-on MAGTF missions associated with the current operation.
- Develop aviation courses of action (COAs) for each follow-on MAGTF mission under development.
- Develop ACE estimates of supportability for each follow-on MAGTF mission under development.
- Develop and refine OPLANs or OPORDs associated with each follow-on MAGTF mission.
- Provide detailed and fully integrated deployment, employment, mobilization, and sustainment plans for follow-on MAGTF missions.
- Prepare necessary briefs for COA and/or supportability decision briefs.
- Assist future operations, as required, after the ACE support plan is transitioned to the operational planning team (OPT) for OPORD or FRAGO detailed preparation.
- Maintain liaison and coordination with the JFACC.

Billet Descriptions

Future Plans Officer

The future plans officer is directly responsible to the ACE G-3 for the overall direction and supervision of future plans. The future plans officer will function as the ACE strategy officer. The future plans officer will—

- Supervise the preparation and setup of future plans.
- Develop aviation strategy for the ACE.
- Develop ACE planning milestones.
- Provide aviation plans and/or estimates of supportability to the MEF future plans section.
- Coordinate ACE staff inputs to the planning process.
- Coordinate with higher, adjacent, and subordinate commands to ensure planning accuracy and timeliness.
- Conduct required plans briefs for the ACE commander and battlestaff.
- Provide tailored personnel support, as directed by the ACE G-3, to assist the future operations orders development section in OPOD or FRAGO preparations.

Senior Planner

The senior planner acts as the planning assistant to the future plans officer. The senior planner will—

- Develop ACE COA and/or estimates of supportability for each follow-on MAGTF mission under development.

MCWP 3-25.4

- Manage the future plans staff and ensure milestones issued by the future plans officer/strategy officer are completed in a timely manner.
- Review planning inputs received from future plans representatives to ensure accuracy and synergy.
- Monitor, collect, and collate future plans inputs to each mission plan.
- Prepare required operations and supporting plans.
- Act as the senior aviation planner if the future plans officer/strategy officer is not an aviator.

Airspace Control Measures Planner

The airspace control measures (ACMs) planner is responsible to the future plans officer for developing ACMs associated with each MAGTF mission plan under development. The ACMs planner will—

- Develop airspace or control concepts necessary to ensure positive and/or procedural control of aviation assets.
- Identify and rectify possible conflicts associated with needed or planned control measures and schemes of maneuver within each COA under development.
- Coordinate with the MACG and the future plans communications and information systems connectivity planner to ensure that each COA is supportable.
- Identify and report the pros and cons of airspace control for each COA developed during mission planning to the senior planner.

- Act as the primary liaison with MAGTF future plans, joint air operations center (JAOC), combat plans, air strategy cell, and MACG in matters pertaining to airspace control planning.
- Assist the ACA in the development of the ACP.

Air Defense Planner

The air defense planner is responsible to the future plans officer for developing ADPs associated with each MAGTF mission plan under development. The air defense planner will—

- Develop air defense concepts necessary to ensure positive and/or procedural control of air defense assets.
- Coordinate air defense battle planning and procedures with the sector air defense facility (SADF).
- Identify and rectify possible conflicts associated with needed or planned control measures and schemes of maneuver within each COA under development.
- Coordinate with the MACG and the future plans communications and information systems connectivity planner to ensure each COA is supportable.
- Identify and report the pros and cons of air defense for each COA developed during mission planning to the senior planner.
- Coordinate with MAGTF's future plans, JFACC's combat plans air strategy and air defense cells, and MACG in matters pertaining to air defense planning.
- Develop ADPs for future operations.

Assault Support Planner

The assault support planner is responsible to the future plans officer for developing all support aviation plans and estimates of supportability associated with each MEF mission plan under development. The assault support planner will—

- Develop aviation plans associated with assault support and general aviation support including helicopterborne operations, tanker support, and unmanned aircraft system (UAS) use.
- Identify and rectify possible conflicts associated with assault support and general aviation support availability and the schemes of maneuver within each COA under development.
- Identify and report assault support and general aviation support pros and cons for each COA developed during mission planning to the senior planner.
- Coordinate with cognizant Marine aircraft groups (MAGs), air-space planner, and the future plans staff to ensure each COA is supportable in terms of deconfliction and support required.
- Act as the primary liaison between future plans and MAGTF future plans in matters pertaining to helicopterborne and general aviation support operations.

Strike Support Planner

The strike support planner is responsible to the future plans officer for developing strike aviation plans/estimates of supportability associated with each MAGTF mission plan under development. The strike support planner will—

- Develop aviation plans associated with air interdiction, offensive anti-air warfare (OAAW), close air support (CAS), UAS use (in conjunction with ACI), and tactical aviation support.

- Identify and rectify possible conflicts associated with strike aviation support availability and the schemes of maneuver within each COA under development.
- Identify and report strike aviation support pros and cons for each COA developed during mission planning to the senior planner.
- Coordinate with cognizant MAGs, airspace planner, and the future plans staff to ensure each COA is supportable in terms of deconfliction and support required.
- Act as the primary liaison between ACE future plans and MAGTF future plans in matters pertaining to air interdiction, OAAW, and CAS operations.

Functional Staff Planners

Intelligence Planner

The intelligence planner is the primary liaison between future plans and the ACE G-2. The intelligence planner will—

- Prepare intelligence annexes and estimates for operations and supporting plans developed by future plans.
- Provide future plans intelligence updates and estimates throughout the mission planning cycle.
- Produce, collate, and submit priority intelligence requirements (PIRs) needed by future plans for mission planning.
- Provide the ACE G-2 with periodic COA and mission briefs to allow them to prepare for upcoming mission changes.
- Provide the future plans officer/strategy officer and senior planner updated intelligence asset availability and status.

MCWP 3-25.4

- Maintain and update the current and projected enemy situation in future plans.
- Prepare and deliver the intelligence portion of briefs provided to the ACE commander and ACE battlestaff by future plans.

Logistic Planner

The logistic planner is the primary liaison between future plans and the ACE G-4. The logistic planner will—

- Prepare logistic annexes for operations and supporting plans developed by future plans.
- Develop logistic estimates of supportability for all COA provided by the MAGTF future plans.
- Populate and maintain automated logistic databases within applicable systems; e.g., theater battle management core system (TBMCS) for use within future plans.
- Provide the ACE G-4 with periodic COA and mission briefs to allow them to prepare for upcoming mission changes.
- Prepare and deliver the logistic portion of all briefs provided to the ACE commander and ACE battlestaff by future plans.

Aviation Support Planner

The aviation support planner is the primary liaison between future plans and ACE ALD. The aviation support planner will—

- Prepare aviation logistic annexes for all operations and supporting plans developed by future plans.
- Develop all aviation logistic estimates of supportability for all COAs provided by the MAGTF future plans.

- Populate and maintain automated aviation logistic databases within applicable systems (e.g., TBMCS) for use within future plans.
- Provide ALD with periodic COA and mission briefs to allow them to prepare for upcoming mission changes.
- Prepare and deliver the aviation logistic portion of all briefs provided to the commanding general and ACE battlestaff by future plans.

Communications and Information Systems Connectivity Planner

The communications and information systems connectivity planner is the primary liaison between future plans and the ACE G-6. The communications and information systems connectivity planner will—

- Prepare communications and connectivity annexes for operations and supporting plans developed by future plans.
- Assist the airspace/ACM planner in developing necessary connectivity framework to ensure that a robust C2 network can be established for mission plans.
- Develop C2; communications system support; and intelligence, surveillance, and reconnaissance estimates of supportability for all COAs provided by the MAGTF future plans.
- Populate and maintain automated C2; communications system support; and intelligence, surveillance, and reconnaissance databases within applicable systems (e.g., TBMCS) for use within future plans.
- Provide the ACE G-6 with periodic COA and mission briefs to allow them to prepare for upcoming mission changes.

Ordnance Planner

The ordnance planner is the primary liaison between future plans and ACE ALD ordnance. The ordnance planner will—

- Assist the aviation support planner in preparing aviation logistic annexes (relating to aviation ordnance) for operations and supporting plans developed by future plans.
- Develop aviation ordnance estimates of supportability for COA provided by the MAGTF future plans.
- Assist in populating and maintaining automated aviation ordnance databases within applicable systems (e.g., TBMCS) for use within future plans.
- Assist the aviation support planner in providing ALD with periodic COA and mission briefs to allow them to prepare for upcoming mission changes.
- Assist the aviation support planner in preparing the aviation logistic portion of all briefs provided to the ACE commander and ACE battlestaff by future plans.

Embarkation Planner

The embarkation planner is the primary liaison between future plans and ACE G-4 embarkation. The embarkation planner will—

- Assist the logistic planner in preparing logistic annexes (relating to embarkation and movement of personnel, material, and supply) for operations and supporting plans developed by future plans.
- Develop embarkation estimates of supportability for COA provided by the MAGTF future plans.

- Populate and maintain automated embarkation databases (e.g., aviation, shipping, amphibian) within applicable systems (e.g., Marine Air-Ground Task Force War Planning System II [MAGTF II]) for use within future plans.
- Assist the logistic planner in providing the G-4 with periodic COA and mission briefs to allow them to prepare for upcoming mission changes. Assist the logistic planner in preparing the logistic (embarkation) portion of briefs provided to the ACE commander and ACE battlestaff by future plans.
- Collate and prepare load plans required for movement of ACE forces in support of mission plans.

Senior MAGTF Planner

The senior MAGTF planner is responsible to the future plans officer for matters relating to planning administration and systems maintenance. The senior MAGTF planner will—

- Use and manage the Global Command and Control System (GCCS).
- Develop, refine, and manage the time-phased force and deployment data.
- Produce, maintain, and update friendly dispositions (current and projected) using standard military symbols, tactical maps, and charts associated with the theater of operations and used by future plans for planning purposes.
- Type, reproduce, and disseminate all briefs, OPORDs, OPLANs, supporting plans, and estimates of supportability produced by future plans.
- Populate and maintain automated databases and briefing charts within applicable systems (e.g., MAGTF II, TBMCS) for use within future plans.

MCWP 3-25.4

- Provide general support to future plans.
- Manage assigned MAGTF planners.
- Report all problems relating to equipment, communications, and personnel to the future plans officer.

MAGTF Planners

MAGTF planners are responsible to the future plans officer for all administrative and communications functions associated with future plans. MAGTF planners will—

- Use and manage GCCS.
- Develop, refine, and manage the time-phased force and deployment data.
- Produce, maintain, and update friendly dispositions (current and projected) using standard military symbols, tactical maps, and charts associated with the theater of operations and used by the future plans staff for planning purposes.
- Type, reproduce, and disseminate briefs, OPORDs, OPLANs, supporting plans, and estimates of supportability produced by future plans.
- Populate and maintain automated databases and briefing charts within applicable systems (e.g., MAGTF II, TBMCS) for use within future plans.
- Provide general administrative support to future plans.
- Maintain communications with higher, adjacent, and subordinate commands using all available communications and dissemination equipment.

Layout

The future plans layout is shown in figure 2-4.

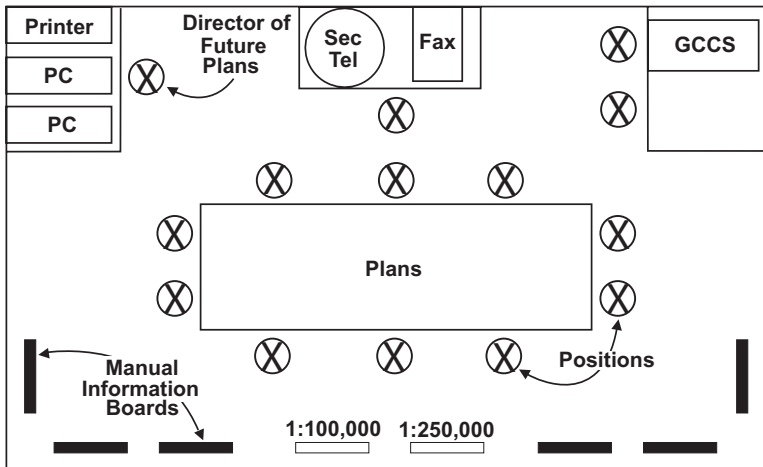

Fax - facsimile
PC - personal computer
Sec Tel - secure telephone

Figure 2-4. Future Plans Layout.

Section II. Future Operations

Organization and Manning

Future operations is comprised of personnel from the ACE staff, MAG, MACG, Marine tactical air command squadron (MTACS),

MCWP 3-25.4

as well as ground combat element (GCE) and logistics combat element (LCE) representation. The MAGTF G-3 provides the personnel for the ground watch section. Aviators assigned to future operations must be rank representative, experienced, and Fleet-seasoned aviators in order to plan aviation events.

Functional staff representation is provided, as required, to facilitate planning. Future operations is organized as shown in figure 2-5.

While not structured for two watch crews, the PDE&A timeline may require shifting personnel to meet critical events during the day (e.g., ATO planning, ATO electronic build, ATO quality control review, ATO merge, orders development, orders review,

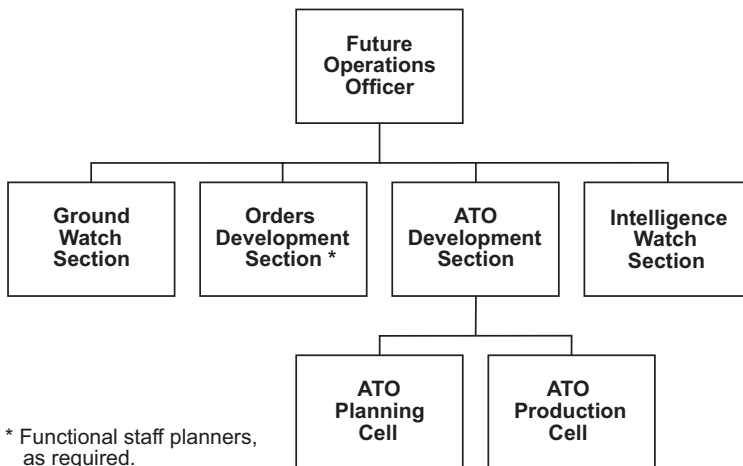

Figure 2-5. Future Operations.

orders release). The cell leaders will structure their personnel to meet critical PDE&A points during the 24-hour day.

Concept of Organization

Similar to future plans, future operations is organized along a cellular structure with a nucleus of aviators, ground and intelligence personnel, and system operators. As required, cross-functional staff/MAG representation will expand future operations to provide expertise for planning functions. These integrated planning cells provide credible, expedient, and synergistically developed input to the orders preparation process.

Mission and Functions

Future operations is responsible to the ACE G-3 for developing future MEF ATOs, writing the OPORD or FRAGO for the next ACE mission and conducting current planning. Future operations will—

- Maintain close and continuous liaison with MAGTF future operations, force fires, and the JAOC combat plans division.
- Plan and produce the next ATO(s) using approved planning guidance.
- Develop ACE OPORDs or FRAGOs based on ACE support plans prepared by future plans.
- Administer the ACE targeting board, as required.
- Formulate current plans outside the ATO cycle, but still within the current OPORD or FRAGO.

MCWP 3-25.4

- Develop the ACE's air apportionment recommendation.
- Plan and coordinate changes to the ACP, ACO, and ADP.
- Direct, coordinate, and supervise the development and forwarding of the ACE commander's critical information requirements.
- Provide the nucleus for the ACE OPT.

Billet Descriptions

Future Operations Officer

The future operations officer is directly responsible to the ACE G-3 for the overall direction and supervision of future operations. The future operations officer will—

- Draft preliminary targeting guidance for presentation to the ACE targeting board when the ACE is employed as a maneuver unit.
- Supervise the preparation and setup of future operations.
- Issue the approved planning guidance and direct and monitor development of the ATO based on that guidance.
- Develop the ACE master air attack plan (MAAP).
- Prepare the allocation request (ALLOREQ) and air support request (AIRSUPREQ) messages, as required.
- Prepare the sortie allotment (SORTIEALOT) message if JFACC.
- Develop the ACE apportionment recommendation.
- Work with the Marine LNO and the Marine liaison element at the combined air operations center (CAOC) to ensure incorporation of Marine direct support ATO and other MAGTF submissions to the CAOC-produced documents (ACP, ACO, and special instructions [SPINS]).

- Review the results of previous air operations and ensure that applicable tactics or procedures are developed as the dynamic combat situation requires (combat assessment).
- Consult with the current operations officer to determine significant problems in managing the current ATO to improve the quality and effectiveness of future ATO tasking.
- Prepare reports from future operations for the commander's situation report and commander's daily briefing and as directed by the ACE G-3.
- Ensure that backup procedures are prepared and can be implemented rapidly if automated planning systems fail.
- Attend briefings to the ACE commander and ACE G-3 concerning upcoming operations about to be put into an ATO.
- Keep future operations informed of the joint force commander's (JFC's), MAGTF commander's, and ACE commander's guidance, intent, and objectives.
- Attend meetings as required and provide input into the ACE support plan being developed by future plans.
- Receive (transition) the developed ACE support plan and provide direction to the orders development section to standup an OPT and to prepare a detailed ACE OPORD or FRAGO.

Assistant Future Operations Officer

The assistant future operations officer is responsible for the internal functioning of future operations in accordance with the future operations officer's guidance and direction. The assistant future operations officer will be prepared to assume all duties of the future operations officer when required.

Operations Administration Section

The operations administration section is responsible for providing administrative support to future operations. It will—

- Receive and distribute all incoming messages and reports.
- Maintain and distribute classified material as required.
- Coordinate the collection of all future operations data for reporting purposes (e.g., commander's situation report, sortie allocation).
- Ensure any messages required for immediate release are drafted and presented to the ACE G-3 administration section.
- Provide general administrative support to future operations.

Ground Watch Section

The ground watch section acts as the MAGTF and GCE commanders' representative to the Marine TACC, and it is comprised of representatives from both the MAGTF and GCE. The ground watch section is located within the Marine TACC and provides the necessary interface for an expedited exchange of information and coordination of current operational planning data. The ground watch section will—

- Monitor and interpret future MAGTF battle plans for future operations.
- Maintain the current and future friendly ground situation displays/maps including planned fire support coordination measures (FSCMs).
- Assist in interpreting the MAGTF commander's guidance and intent for aviation planning purposes.
- Coordinate and deconflict (as required) ground maneuver and supporting arms with planned air operations beyond the FSCL.

Intelligence Watch Section

The intelligence watch section is responsible for receiving, processing, and disseminating pertinent intelligence on the current and future enemy situation to future operations. The intelligence watch section will—

- Serve as the primary interface between the ACE G-2 and future operations.
- Maintain a display of the current and future enemy situation to include target locations and priorities.
- Review all incoming intelligence reports (INTREPs) for significant developments, specific threat changes, and trends in the current situation that could affect future enemy capabilities and COAs.
- Brief the future operations officer on significant changes to the current enemy situation and any developments that will have an effect on future enemy COAs.
- Coordinate with the ACI collections section for the development of intelligence collection plans to support ACE operations and ATO development in planning.
- Advise future operations on—
 - Projected enemy capabilities.
 - Projected enemy critical vulnerabilities.
 - Potential enemy COAs.
 - MAGTF surveillance and target acquisition capabilities.
 - The current and future ACE intelligence collection plan.
- Participate in the intelligence preparation of the battlespace (IPB) process to help determine named areas of interest, target areas of interest, and decision points.

MCWP 3-25.4

- Conduct situation update briefings for future operations and visitors as required.
- Prioritize, collate, and forward requests for information from future operations to the ACI requirements and dissemination section for action.
- Coordinate with the ACI intelligence analysis section for the projected enemy battlefield situation.
- Coordinate with the ACI target development cell to develop a target list to be weaponeered by the strike planners.
- Coordinate with the ACI BDA cell to provide status of previously scheduled targets and participate as a member on the combat assessment board for target resubmission.

ATO Development Section

The ATO development section is responsible for ATO planning, production, and dissemination in support of MAGTF air operations as well as identifying MAGTF targets for common sourcing. It is comprised of the ATO planning cell and ATO production cell.

ATO Development Officer

The ATO development officer is responsible to the future operations officer for overseeing the ATO planning and ATO production cells. The ATO development officer will—

- Receive, interpret, and disseminate direction from the future operations officer.
- Produce a timely and executable ATO.
- Ensure aviation and intelligence databases required for ATO planning and production are current and accurate.

- Coordinate with the deep battle cell and close battle cell in current operations to ensure accuracy of the published ATO.
- Coordinate with the senior watch officer (SWO) in current operations to ensure timely receipt of current battle information.
- Coordinate changes to the ATO being executed that could affect the ATO(s) under development.
- Maintain contact with the ACE augmentation cell in the JAOC combat plans division.
- Provide output from the combat assessment board to the MAGTF air officer and JAOC combat plans division.
- Head the combat assessment board with BDA input from the ACE target intelligence officer and munitions effectiveness or strike profiles provided by the flying units

The combat assessment board draws input from two sources and—

- Receives an intelligence assessment from the target intelligence officer in the form of BDA inputs.
- Receives operational inputs from the flying units describing munitions effectiveness, strike profile effectiveness, tactics effectiveness, countermeasures equipment, expendables effectiveness, etc.

ATO Planning Cell

The ATO planning cell is responsible for performing weaponeering and force application functions in the development of the MAGTF master air attack plan (MAAP).

MCWP 3-25.4

The ATO planning cell will—

- Receive and review the MAGTF MAAP.
- Prepare the ACE MAAP to include—
 - Sequencing and deconflicting apportioned air assets against the MAGTF prioritized target list.
 - Weaponing and packaging air assets, as required, based on the threat, desired level of destruction, and timeliness.
 - Deconflicting simultaneous missions by other MAGTF lethal or nonlethal assets.
 - Preparing sortie available charts.
 - Preparing aircraft flow sheets.
 - Separating the MAGTF prioritized target list (for submission to the JFC) to show direct support and common sourced targets.
 - Reviewing and inputting any air operations database (AODB) changes to the aircraft laydown, standard configured loads, and aircraft parametric data.
 - Preparing the target planning worksheets and passing them to the ATO production cell for input into the applicable electronic planning system.
 - Preparing the SPINS and any changes to ACP and ADP for incorporation into the ATO.
 - Performing a final review of the ATO before release or forwarding.
 - Ensuring that sortie available aircraft flow and target planning worksheets, as applicable, are forwarded to the Marine liaison cell in the JAOC combat plans division.

- Adjusting force packaging, routing, weapons loadout, aircraft survivability equipment configurations, or other tactics resulting from the combat assessment board analysis.
- Establishing assault support flow and sustainment plan.

ATO Production Cell

The ATO production cell is responsible for the technical construction and dissemination of the ATO, SPINS, and ACP/ACO/ADP inputs. The ATO production cell will—

- Receive and review the target planning worksheets from the ATO planning cell and input listed targets into the applicable electronic planning medium.
- Prepare ATO, SPINS, ACP, ACO, and ADP changes in accordance with the information, data, and guidance provided by the ATO planning cell.
- Print and deliver draft copies of the ATO for review by the ATO planning cell prior to release or forwarding.
- Maintain electronic connectivity with the JFACC for the submission of common sourced target nominations and the merging of the MAGTF direct support ATO into the joint ATO.
- Publish and transmit the ATO to higher, adjacent, and subordinate commands using available electronic means in accordance with the dissemination plan.
- Monitor the status of the theater-directed electronic planning and execution medium and associated equipment to identify maintenance requirements and equipment problems.

Orders Development Section

The orders development section is responsible for developing ACE OPORDs or FRAGOs and conducting current planning for aviation requirements that occur beyond the ATO currently being planned but short of the next FRAGO being developed.

Orders Development Officer

The orders development officer is responsible to the future operations officer for overseeing the orders development and current planning process. The orders development officer will—

- Stand up and direct the ACE OPT.
- Develop ACE OPORDs or FRAGOs based on ACE support plans prepared by future plans.
- Plan and coordinate large-scale helicopter operations (taskings, routes, escort), projected strike packages, joint combat search and rescue (CSAR), tactical recovery of aircraft and personnel (TRAP), combat air patrol (CAP), suppression of enemy air defenses, air C2 functions, and aviation support requirements to meet planned aviation needs beyond the ATO timeline but short of the next significant change to the major subordinate command (MSC) mission being developed by future plans.
- Assist with functions required to meet ATO timelines.
- Coordinate continuously with the ATO development officer and the future operations officer about orders development and near-term plans and requirements.
- Prepare plans associated with reorganization, liaison and augmentation, and connectivity required to assume JFACC/JAOC responsibilities, as required.

Layout

The future operations layout is shown in figure 2-6.

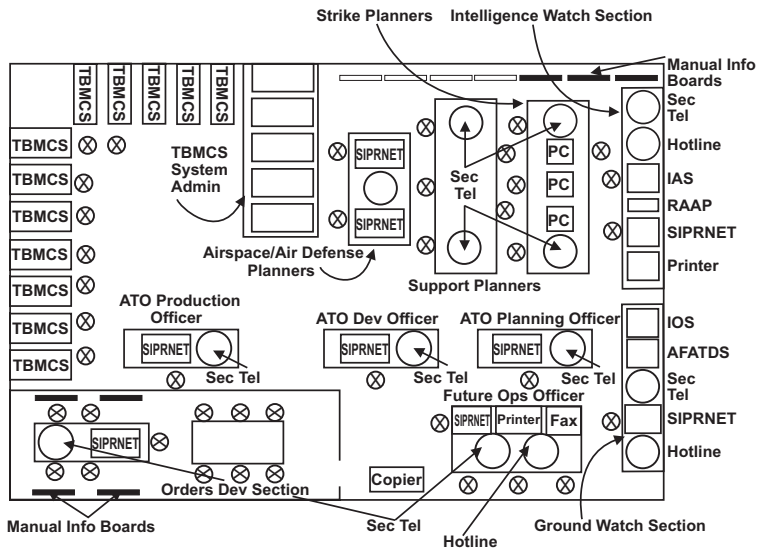

Dev - development
 Fax - facsimile
 Info - information
 IOS - intelligence operations system
 Ops - operations
 PC - personal computer

Sec Tel - secure telephone
 SIPRNET - SECRET Internet Protocol Router Network
 AFATDS - Advanced Field Artillery Tactical Data System
 IAS - intelligence analysis system
 RAAP - rapid application of air power

Figure 2-6. Future Operations Layout.

Section III. Current Operations

Organization and Manning

Current operations is comprised of personnel from the ACE staff, MAG, MACG, as well as GCE and LCE representation. Pilots and naval flight officers, as required, will be drawn from MAGs to fill critical billets that require the expertise of a Marine aviator or naval flight officer. The MAGTF G-3 provides the personnel for the ground watch section. Current operations must be manned with sufficient personnel to maintain sustained 24-hour operations. This normally requires a minimum of two 12-hour watch crews. Current operations is organized as shown in figure 2-7.

Concept of Organization

Current operations is organized by sections divided into cells to promote the rapid distribution of relevant information necessary to make sound decisions in a fluid battlefield environment. Each cell has clearly defined tasks and is given the latitude to interact freely as necessary with other cells whose knowledge and expertise are required for the situation at hand. The goal is to compress the time needed to make decisions and coordinate execution. This lateral coordination among cells improves operational tempo by fostering the unrestrained flow of information and allowing multiple cells to simultaneously work different issues. As a result, the time needed to make meaningful decisions and coordinate execution is shortened. The ACE can gain an advantage by cycling

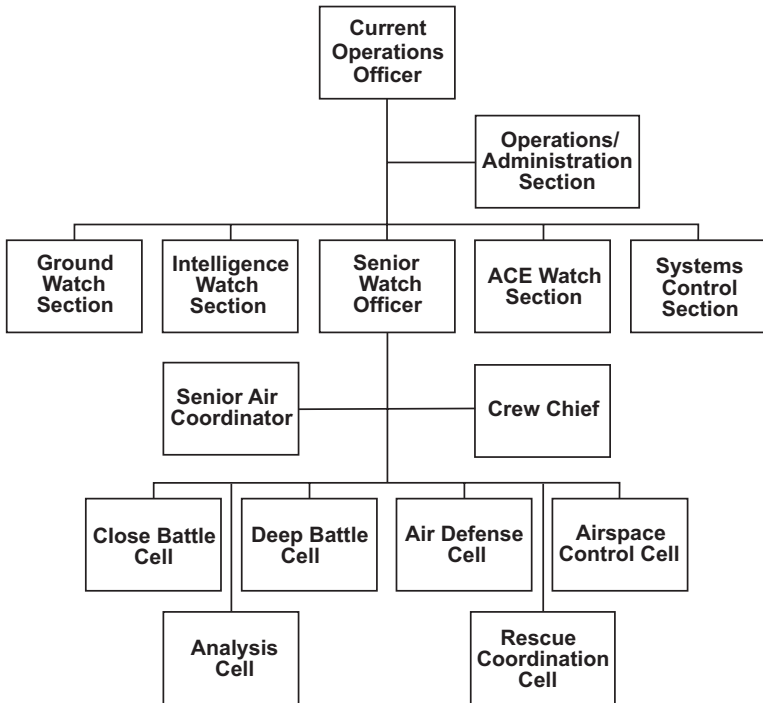

Figure 2-7. Current Operations.

through their observe, orient, decide, act (OODA) loop process faster than an adversary can cycle through theirs.

To ensure timely and accurate assessment, decisionmaking, and execution, current operations is arrayed into three concentric bands. Cells principally tied by purpose and focus are placed where interaction is facilitated to accomplish their assigned functions rapidly and synergistically (see fig. 2-8, page 2-32).

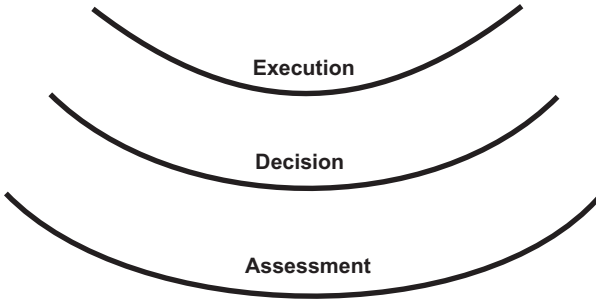

Figure 2-8. Current Operations Concept of Organization.

The outer ring consists of cells that monitor, analyze, and assess warfighting functions. Cells lend credible, expedient, and synergistically developed input to assist the decisionmaking process. These cells receive information from other cells within current operations as well as from the ACE principal staff sections and higher, adjacent, and subordinate units. Information is evaluated, analyzed, fused, and interpreted with the end result being timely, well-developed knowledge presented to decisionmakers, along with recommended COAs, if required.

The middle ring consists of decisionmakers (i.e., the current operations officer [the direct representative of the G-3 responsible for executing current operations] and the SWO [the senior watchstander who continuously directs the execution of the current ATO]). The decisionmaker selects a COA from the options presented by the outer ring based on a detailed understanding of the

MAGTF and ACE commanders' guidance (mission and intent) and directs the applicable execution cell to implement it. The decisionmaker supervises to ensure proper execution but does not get involved in the details of execution unless it is warranted by the situation. This allows the decisionmaker to maintain better overall current situational awareness that assists in making more informed subsequent decisions.

The inner ring consists of cells that are task-organized to fully implement the six functions of Marine aviation through direct connectivity to higher, adjacent, and subordinate commanders or agencies. Usually, one cell is given the lead for the execution of a specific action, and that cell is responsible for coordinating and deconflicting associated actions with other cells or agencies, as required, during the implementation process. The lead cell is also responsible for providing timely feedback to decisionmakers and applicable assessment cells or agencies, which will reinitiate the process if required.

A key tenet of the cellular organization is the separation of the assessment and execution processes. The assessment cell is focused on monitoring and analyzing the effectiveness of the current ATO as a whole, and not on the details of individual event execution. This separation facilitates an ability to more broadly view the total situation and effect the necessary coordination with other cells, resulting in more meaningful information being provided to decisionmakers. Conversely, by not having to piece together disparate information to provide a current assessment to decisionmakers, execution cells can work out the details of the execution, using their experience and judgment to organize resources and direct aircraft or system employment.

Mission and Functions

Current operations is responsible to the ACE G-3 for the overall operations of the ACE to include executing the current ACE OPOrd or FRAGO and executing the daily ATO and assessing its effectiveness. Current operations will—

- Maintain close and continuous liaison with MAGTF current operations and JAOC combat operations division.
- Manage the execution of the ACE OPOrd or FRAGO.
- Manage the execution of the current ATO.
- Assess and adjust current ACE operations based on changes in MAGTF guidance or the status of friendly and enemy forces situation.
- Analyze and interpret operational environment events as they relate to MAGTF air operations.

Billet Descriptions

Tactical Air Commander

The MAGTF TAC is the ACE commander or in his absence, his designated representative (e.g., assistant wing commander, chief of staff, or the assistant chief of staff G-3).

Current Operations Officer

The current operations officer is directly responsible to the ACE G-3 for the overall direction and supervision of current operations. The current operations officer will—

- Supervise preparation and setup of current operations.
- Execute the current OPORD or FRAGO.
- Execute the ATO.
- Provide the future operations officer with a summary of significant problems encountered in executing the current ATO to improve the quality and effectiveness of future ATO tasking.
- Prepare reports from current operations for the commander's situation report, commander's daily briefing, and other reports as directed by the ACE G-3.
- Ensure that backup procedures are prepared and can be implemented rapidly if automated support systems fail.
- Brief the ACE commander and G-3 on upcoming operations that will be incorporated into an ATO.
- Keep current operations informed of the JFC/JFACC/MAGTF/ACE commander's guidance, intent, and objectives.

Assistant Current Operations Officer

The assistant current operations officer is responsible for the internal functioning of current operations in accordance with the current operations officer's guidance and direction. The assistant current operations officer will be prepared to assume all duties of the current operations officer when required.

Operations Administration Section

The operations administration section is responsible for the administrative functioning of current operations. The operations administration section will—

- Receive and distribute all incoming messages and reports.
- Maintain and distribute classified material as required.
- Coordinate the collection of all data for reporting purposes (e.g., commander's situation report, sortie allocation).
- Ensure any messages required for immediate release are drafted and presented to the G-3 administration section.
- Maintain the operations journal and journal file.

Systems Control Section

The systems control section is responsible for monitoring all ACE communications circuits including data networks, radio networks, and switched voice networks and is the focal point for conducting restoration efforts for networks, systems, and links. The systems control section is comprised of technicians that control the entire ACE communications requirements. The systems control section coordinates with the current operations officer to ensure communications and systems availability. Systems maintenance (TBMCS, GCCS, Advanced Field Artillery Tactical Data System [AFATDS], Intelligence Operations Workstation, air defense operations center, and command and control personal computer [C2PC]) is the responsibility of the system administrators from the G-2, G-3, and MTACS. System administrators work with the systems control section to resolve communications and system outages. For all systems that terminate within the Marine TACC, the C2 systems watch officer is the designated system administrator responsible for reporting system outages.

C2 Systems Watch Officer (Marine TACC Maintenance Coordinator)

The C2 systems watch officer is an extension of the ACE G-6 and acts as the focal point for maintaining the Marine TACC communications system status and initiates restoration priorities of all circuits (e.g., radio, wire, tactical data networks, and multichannel radio) as the Marine TACC maintenance coordinator (dual-tasked as the communications watch officer in the ACE watch section). The C2 systems watch officer will—

- Submit circuit status reports to the ACE G-6 and the operational systems control center, as required.
- Maintain systems and circuit status within the Marine TACC.
- Supervise all communications personnel and system administrators assigned to the watch in radio central.
- Receive system outage or degradation reports by Marine TACC operators and initiate trouble call reporting for circuit or systems restoration action.
- Install and restore circuits in accordance with the established restoration plan.
- Coordinate circuit preemption with all concerned agencies.
- Monitor the progress of equipment under repair by the maintenance troubleshooting team.
- Keep the current operations officer, future operations officer, and/or SWO apprised of any system degradation/outage and ongoing restoration efforts.
- Keep the G-6 and system control section apprised of any emergent current operations communications issue.

Radio Central (Marine TACC Technical Control)

Radio central is the facility adjacent to current operations that is the terminus for single channel radio nets. When directed by the ACE system control section, it will coordinate or conduct radio or data circuit restoration. It will be manned by ACE communications or data personnel.

Ground Watch Section

The ground watch section is responsible for providing updated friendly ground situation information. It is comprised of representatives from the MAGTF G-3. The ground watch section will—

- Monitor and interpret the current friendly ground battle for current operations.
- Maintain the friendly ground situation including current and planned FSCMs.
- Assist in interpreting the MAGTF commander's guidance and intent for current operations planning purposes.
- Act as the conduit for the receipt of all MAGTF-approved, preplanned requests for aviation support.
- Deconflict (as required) ground maneuver and supporting arms with air operations beyond the FSCL.
- Provide status on the air effort to the MAGTF current operations.
- Coordinate changes to MAGTF targets and priorities with MEF force fires.
- Advise current operations on restrictive FSCMs.

Intelligence Watch Section

The intelligence watch section is responsible for receiving, processing, and disseminating current intelligence on the enemy situation to current operations. The intelligence watch section will—

- Serve as the primary interface between the ACE G-2 and current operations.
- Maintain a current display of the enemy situation including target locations and priorities.
- Review all incoming INTREPs for significant developments, specific threat changes, and trends in the current situation.
- Brief current operations on significant changes to the current enemy situation and any developments that will have an effect on future enemy COAs.
- Coordinate with the ACI collection section for the development of intelligence collection plans to support ACE operations and ATO execution.
- Prioritize, collate, and forward requests for information from current operations to the ACI requirements and dissemination section for action.
- Advise current operations on—
 - Enemy capabilities.
 - Enemy critical vulnerabilities.
 - Potential enemy COAs.
 - MAGTF surveillance and target acquisition capabilities.
 - Current ACE intelligence collection plan.

MCWP 3-25.4

- Conduct informal situation update briefings for current operations and visitors.
- Prepare reports from current operations for the command's intelligence summary (INTSUM) as directed by the ACE G-2.
- Ensure that when a high-payoff target is identified, the deep battle cell is notified for possible immediate attack and the situation map and current activity logs are updated.
- Act as the conduit for BDA reporting within current operations.
- Provide initial analysis of perishable information and conduct limited indications and warning reporting within the ACE and to the MAGTF.
- Ensure that current intelligence received through current operations is forwarded to ACI in a timely manner.
- Coordinate with the ACI intelligence analysis section to ensure that current intelligence on the enemy situation is considered in order of battle database maintenance and to verify that the latest order of battle assessment is available on the current situation displays.
- Coordinate with the ACI target intelligence section on immediate target nominations and provide a recapitulation of targets struck and BDA when available.
- Maintain current and forecasted weather information and maps for the entire theater.

ACE Watch Section

The ACE watch section is responsible for monitoring ACE functions that are not directly related to aircraft employment and aircraft and missile control (i.e., current FRAGO or OPORD). The ACE watch section is comprised of the communications watch office (dual tasked as the C2 systems watch officer; logistic watch officer; aviation maintenance and ordnance watch officer;

chemical, biological, radiological, and nuclear (CBRN) watch officer; and force protection officer. Watchstanders ensure that taskings in the OPOD or FRAGO, but not ATO-related, are executed and monitored.

Logistic Watch Officer

The logistic watch officer is an extension of the ACE G-4 in current operations. The logistic watch officer will—

- Maintain the status of the classes of supply.
- Maintain the status of all combat engineering functions in support of the ACE (e.g., airfield, improvement, forward operating base [FOB] status, forward arming and refueling point [FARP] status).
- Maintain status of Marine wing support squadrons at each aircraft site.
- Keep the current operations officer apprised of events/situations that will affect current operations.
- Provide immediate feedback to the G-4 and Marine wing support group S-3 on any ACE logistic issues.

Aviation Maintenance and Ordnance Watch Officer

The aviation maintenance and ordnance watch officer is the direct representative of the ALD officer. The aviation maintenance and ordnance watch officer will—

- Maintain status of all assigned type, model, and series aircraft in theater or en route.
- Maintain status of all ordnance (by type and base) and provide the information through the current operations officer to the deep battle cell and close battle cell, as required.

MCWP 3-25.4

- Provide any changes of status that will affect events in planning to the ALD ordnance representative in future operations.
- Relay any changes in status of aircraft or ordnance to the ALD ordnance section.

Chemical, Biological, Radiological, and Nuclear Watch Officer

The CBRN watch officer is the senior CBRN representative for the ACE G-3. The CBRN watch officer will—

- Maintain mission-oriented protective posture status on all ACE sites and report changes to the current operations officer.
- Provide changes to mission-oriented protective posture via established nets.
- Establish passive CBRN protective measures.
- Maintain connectivity with the ACE CBRN and MAGTF CBRN control centers.
- Maintain and be familiar with the operational exposure guide.

Force Protection Officer

The force protection officer is responsible to the ACE G-3 for all airbase ground defense and rear area security issues. The force protection officer will—

- Be familiar with the ACE force protection plan outlined in the MEF or ACE OPORD or FRAGO.
- Maintain the status of all security forces (ground and aviation) at all ACE sites.

- Maintain connectivity with the MAGTF rear area operations group to ensure seamless rear area security operations.
- Receive requests for, and coordinate the use of, aviation assets (ground forces and aircraft) in the prosecution of a rear area security threat.
- Provide rear area security/force protection requirements to future operations, via the current operations officer, for inclusion in the next ACE FRAGO and ATO.
- Be familiar with the ACE force laydown.
- Track the location and availability of preplanned rear area security aviation assets.
- Coordinate with the close battle cell for aviation requirements that exceed the allotment on the ATO.
- Coordinate with GCE for force protection of ACE elements within GCE area of operations.

Current Operations Watch Crew

The current operations watch crew is responsible for executing the current ATO and for supervising the proper employment of the six functions of Marine aviation during their assigned watch. The current operations watch crew is comprised of a SWO, senior air coordinator (SAC), crew chief, interface coordination/track data cell, air defense cell, airspace control cell, close battle cell, deep battle cell, assessment cell, and RCC.

Senior Watch Officer

The SWO is the senior watchstander in current operations. The SWO is responsible to the current operations officer for the

MCWP 3-25.4

overall direction and supervision of the watch. The SWO will supervise the execution of the current ATO to—

- Evaluate the capability of available forces to fulfill ATO taskings and recommend a COA to the current operations officer when there is a shortfall.
- Keep the current operations officer informed of unexpected developments or problems that might impact planned operations.
- Recommend adjustments to the published ATO when required by the current situation.
- Issue ATO adjustments approved by the current operations officer and document all ATO changes and adjustments.

Note: The SWO is delegated the responsibility of approving these changes in the current operations officer's absence.

- Be familiar with all aspects of air operations including force beddown, sortie availability, ACMs, communications, rules of engagement (ROE), aircraft capabilities and limitations, and munitions capabilities (using the execution cells for MOS expertise, as required).
- Effect coordination with SWOs of subordinate, adjacent, and senior air-ground agencies.
- Monitor reporting of events by agencies subordinate to the Marine TACC.
- Adjudicate with the MEF or JFACC any immediate joint tactical air strike requests (JTARs) or assault support requests (ASRs) that exceed the current planned allocation.

- Determine reporting responsibilities and establish procedures for preparing reports from current operations for the commander's situation report, commander's daily briefing, and as directed by the current operations officer.
- Perform the functions of the current operations officer when directed.

Senior Air Coordinator

The SAC is the senior MACCS watchstander in current operations. The SAC is responsible to the SWO and assists in supervising the watch crew. The SAC will—

- Ensure that situation and status displays are current and accurate.
- Monitor the DASC's direction of Marine Corps aircraft operations allocated to the MEF close/rear battle with the appropriate aircraft group(s) via the air boss(es) or appropriate C2 node.
- Coordinate with the DASC and the applicable air boss(es) or appropriate C2 node on the execution of close and rear operations.
- Monitor the TAOC's control of MEF and joint air defense operations.
- Coordinate with the TAOC and the applicable air boss(es) or appropriate C2 node on the execution of air defense operations.
- Advise the SWO on all matters pertinent to the MACCS in the conduct of current operations.
- Assist the SWO in supervising the execution of the current ATO.

MCWP 3-25.4

- Be familiar with all aspects of air operations, to include force beddown, sortie availability, ACMs, communications, ROE, aircraft capabilities and limitations, and munitions capabilities (using the execution cells for MOS expertise, as required).
- Assist the SWO in coordinating with SWOs of subordinate, adjacent, and senior air-ground agencies.
- Monitor reporting of events by agencies subordinate to the Marine TACC.
- Perform the functions of the SWO, when required.
- Coordinate with an internal maintenance coordinator (working directly for the SAC and crew chief) who will be responsible for MTACS provided equipment (e.g., multiple source correlation system, MESHnet, TBMCS, mobile electric power [MEP] units, environmental control units [ECUs], and shelters). The internal maintenance coordinator will keep the system control section and radio central advised and coordinate troubleshooting and restoration efforts for MTACS organic equipment.

Crew Chief

The crew chief is the senior enlisted MACCS crewmember and is responsible for the efficient functioning of the watch crew. The crew chief will—

- Assist recorders and net operators.
- Receive and distribute all operational messages.
- Maintain logbooks and records for ATO-related activities.
- Perform other duties as directed by the SWO.
- Coordinate the repair priority of all operator equipment malfunctions with the Marine TACC maintenance coordinator.

Deep Battle Cell

The deep battle cell is responsible to the SWO for the management of all aviation assets assigned to, or available to, the ACE that will be used in the prosecution of the MEF deep battle. The deep battle cell will—

- Function as the deep battle air director for aircraft operating forward of the FSCL.
- Direct all Marine Corps aircraft and any joint or combined assets allocated to the MAGTF for prosecution of the MEF deep battle.
- Direct Marine Corps aircraft operations, allocated for the MEF deep battle, with the appropriate aircraft group(s) via the air boss(es) or appropriate C2 node.
- Coordinate with the airspace control cell on the use of, and/or the need for, ACMs in the MEF deep battle area.
- Coordinate with the applicable air boss(es) or appropriate C2 node on the execution of deep operations. Upon SWO approval, the deep battle cell will direct the—
 - Canceling of deep missions in cases where requirements no longer exist.
 - Launching of preplanned deep missions.
 - Diverting of preplanned deep missions (also provide mission briefs to the aircrews via available means).
 - Altering of scheduled launch times to meet new deep requirements generated by changing tactical situations.
 - Appropriate ordnance load-out for deep, alert aircraft launched against unscheduled targets as determined by the assessment cell.

MCWP 3-25.4

- Notify SWO of changes in deep asset availability.
- Coordinate requests for JFACC assets for any deep requirements that exceed ATO asset availability or capability (time dependent). Monitor and coordinate the movement of all MAGTF-controlled UAVs operating in the MEF deep battle area.
- Coordinate all dynamic retaskings of MAGTF-controlled UAVs (operating in the MEF deep battle area) with the airspace control cell, the close battle cell, the Marine UAV squadron, and the MAGTF surveillance and reconnaissance center.
- Provide aviation expertise to the air defense cell.

Close Battle Cell

The close battle cell is responsible to the SWO for the management of all aviation assets, assigned to or available to the ACE, that will be used in the prosecution of the MEF close or rear battle. The close battle cell will—

- Coordinate with the airspace control cell on the use of, and/or the need for, ACMs in the MEF close or rear battle areas as requested by the DASC.
- Direct, on SWO approval and in coordination with the DASC, the—
 - Canceling of close/rear missions when the requirement no longer exists.
 - Launching of preplanned, close/rear missions.
 - Diverting of preplanned, close/rear missions.
 - Altering of scheduled launch times to meet new close/rear requirements generated by changing tactical situation.
- Notify the SWO of changes in close asset availability.

- Coordinate with the Marine liaison element in the CAOC/JAOC for joint support to existing Marine JTARs and ASRs.
- Coordinate with the DASC to receive immediate JTARs and ASRs.
- Coordinate with the MAGTF air officer and the FFCC to receive updated guidance on shifting assets for those requests that exceed allocation.
- Coordinate with the deep battle cell on asset availability for JTARs and ASRs before jointly recommending a COA to the SWO.
- Coordinate, through the SWO, with the deep battle cell for asset shifting.
- Coordinate with the ground watch section for updates on friendly unit locations.

Air Defense Cell

The air defense cell is responsible for coordinating air defense within the MAGTF's area of operations. The air defense cell will—

- Monitor, supervise, and direct the control of aircraft and missiles for air defense by subordinate MACCS agencies.
- Coordinate air defense operations of MACCS agencies with external agencies.
- Coordinate theater missile defense operations with external agencies.
- Initiate orders to MACCS agencies for air defense and countermand subordinate agency actions as required.
- Monitor the equipment status and operational posture of MACCS agencies relative to air defense.
- Coordinate the establishment and dissemination of alert conditions.
- Coordinate the establishment and dissemination of weapons release conditions.

MCWP 3-25.4

- Direct the TAOC on the execution of air defense missions. As directed by the SWO, and in coordination with the deep battle cell, the air defense cell will—
 - Cancel missions when requirements no longer exist.
 - Divert preplanned missions and provide mission briefs.
 - Alter scheduled launch times to meet new time-on-station requirements generated by changing tactical situations.
 - Direct launches of unscheduled missions and provide mission briefs.
 - Recommend the reconstitution of on-call (strip alert) missions.
- Ensure that displays are current and keep the SWO briefed on the air defense situation.
- Ensure that all air defense activities are coordinated properly with the rest of current operations and subordinate sector air defense commanders when the Marine TACC has been designated as a regional air defense commander by the AADC. These activities include:
 - Coordinating movement of CAP stations.
 - Coordinating alternate sectors of responsibility.
 - Recommending changes in weapons control status(s) and air defense warning conditions to the SWO.
 - Coordinating ground-based air defense assist activities within the air defense region.
- Coordinate ACMs with the airspace control cell.
- Ensure that established cross-tell procedures are used by subordinate air defense agencies and units.

Airspace Control Cell

The airspace control cell is responsible for all airspace issues. The airspace control cell will—

- Coordinate with the ground watch section for the plotting and deconfliction of FSCMs as they affect air operations.
- Be familiar with joint, Federal Aviation Administration, host nation, and JFACC airspace procedures.
- Deconflict with external military and civilian host nation agencies by coordinating with the ACA for all immediate (current ATO) airspace requirements beyond the FSCL.
- Update and monitor changes to the ACP/ACO/SPINS and apprise all watchstanders of changes and ensure all applicable display mediums are current.
- Coordinate any airspace requirements affecting the DASC, TAOC, close battle cell, deep battle cell, air defense cell, appropriate Marine air traffic control mobile team and air boss(es), and the RCC.

Interface Coordination/Track Data Cell

The interface coordination/track data cell is responsible for ensuring an accurate situation display and an orderly functioning of all data links. They are also responsible for track coordination within the MACCS and other tactical data systems. The interface coordination/track data cell will—

- Provide track coordination within the MACCS and other tactical data systems by—
 - Resolving track reporting conflicts.

- Resolving dual-track designations.
- Initiating drop-track orders.
- Resolving identification conflicts.
- Initiating handover orders.
- Readdressing incoming and outgoing orders, as required.
- Supervise the proper use of manual cross-tell procedures.
- Recommend changes to data link configuration.
- Ensure the data link picture is an accurate presentation of current air operations.
- Ensure accurate and timely publishing of coordinating instructions for data link employment—via the operations task link (OPTASKLINK) message format—with the communications and information systems connectivity planner.
- Recommend the establishment of surveillance sectors for suitably equipped platforms commensurate with their surveillance capabilities via the tactical operational data (TACOPDAT) message format.
- Assign responsibility for establishing and reporting special points for interface among all link participants.
- Ensure that surveillance and combat identification procedures are disseminated and executed in accordance with published orders.
- Use data link filters to protect participating units and databases without degrading the air situation display.
- In conjunction with the TAOC's interface control officer, monitor all tactical digital information links (TADILs) and make or recommend changes to optimize link quality.

Assessment Cell

The assessment cell is responsible for monitoring and assessing the effectiveness of all aviation functions in support of the total MAGTF battle (rear, close, and deep). The assessment cell will—

- Acquire and maintain current information on the status and operations of air missions in support of the MAGTF rear, close, and deep battles.
- Advise the current operations officer and/or SWO, as required, on the employment of air assets in support of the MAGTF's rear, close, and deep battles.
- Review MAGTF targeting guidance and combat assessment data (e.g., BDA, munitions effectiveness) to provide ATO refresh input to planned events at least 4 hours prior to execution. Provide the single point of contact within current operations for the synchronization of air operations in support of the MAGTF rear and close battle and with MAGTF deep attacks planned inside the ATO cycle.
- Coordinate with the ACI target intelligence section to receive updated targeting and BDA information.
- Coordinate with the intelligence watch section for current or projected enemy capabilities, enemy critical vulnerabilities, and potential enemy COAs.
- Coordinate with the ground watch section to receive updated MAGTF targeting guidance.
- Coordinate with the ground watch section for current or projected ground scheme of maneuver, fire support plan, boundaries, and FSCMs.

MCWP 3-25.4

- Receive in-flight reports from the deep and close battle cells and pass to the intelligence watch section for simultaneous review and processing.
- Recommend to the SWO dynamic retasking of air assets in response to emergent targets in the deep battle area (coordination with ACI target intelligence section is required).
- Assess the impact of shifting assets on the rear, close, and deep battles during the current ATO.
- Recommend changes to, or identify preplanned ordnance configurations in response to, target changes or changing weather conditions.
- Maintain liaison with the DASC, the MAGTF air officer, and the fire support coordinator.
- Recommend and coordinate ACMs with the airspace control cell for events being planned (e.g., kill box shift, minimum risk route activation).

Rescue Coordination Cell

The RCC is responsible for coordinating search and rescue and/or the TRAP. The RCC coordination cell will—

- Supervise activating and monitoring of RCC nets and execution checklists, as required.
- Draft all messages pertaining to MAGTF RCC and TRAP operations (e.g., search and rescue incident report).

- Coordinate with the joint search and rescue center (JSRC) concerning TRAP aircraft availability and requirements for assets that exceed ACE platform capabilities and survivability for RCC operations.
- Notify the SWO of supporting aircraft requirements for RCC and TRAP operations, the progress of RCC and TRAP operations, and any situations that restrict or hinder RCC and TRAP operations.
- Coordinate RCC and TRAP efforts with units and/or agencies external to the ACE (e.g., JFACC at the JSRC and adjacent rescue coordination centers).
- Coordinate RCC and TRAP efforts with the air defense cell, deep battle cell, and close battle cell whenever such efforts transit the affected airspace.
- Ensure that RCC and TRAP reports are completed and maintained.
- Monitor and update (including reconstitution, location, and availability) RCC and TRAP assets.
- Provide feedback to future operations on changes required for subsequent ATOs concerning RCC and TRAP support (e.g., packaging, SPINS, checklists).

Layout

Figure 2-9, on page 2-56, illustrates the current operations layout.

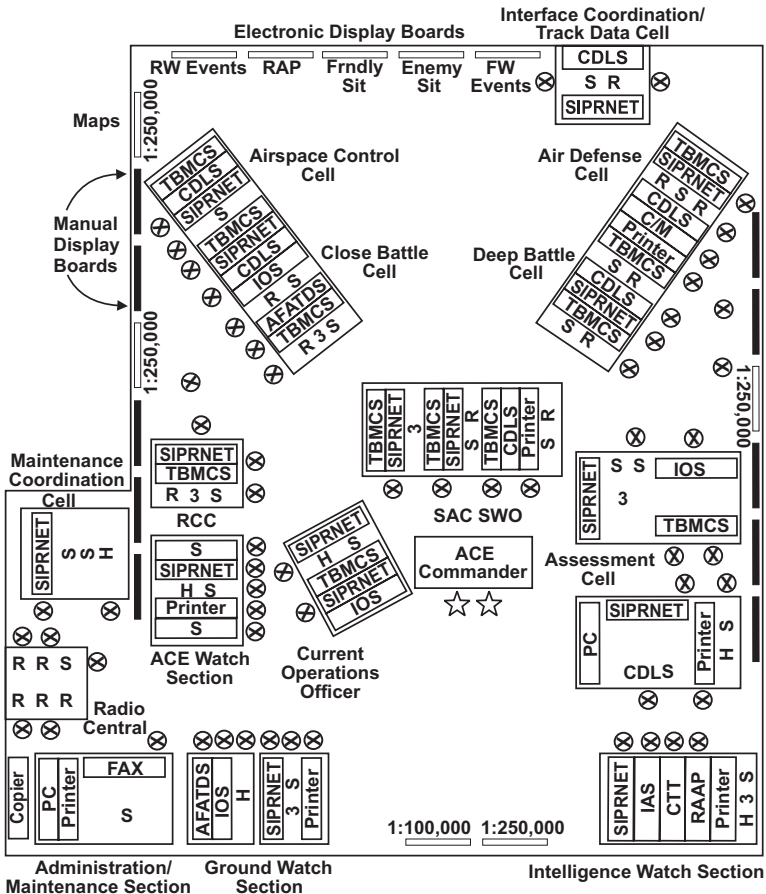

- 3 - Secure Telephone Unit III
- FAX - Facsimile
- CDLS - communications data link system
- C/M - TBMCS/CDLS
- CTT - commander's tactical terminal
- Frndly - friendly
- FW - fixed wing
- H - hotline
- IOS - intelligence operations system
- PC - personal computer
- R - radio
- RAP - recognized air picture
- RW - rotary wing
- S - secure telephone
- SIPRNET - SECRET Internet Protocol Router Network
- Sit - situation

Figure 2-9. Current Operations Layout.

Section IV. Air Combat Intelligence

Organization and Manning

ACI is organized as shown in figure 2-10, on page 2-58. Manning of ACI is a combined effort using personnel from the ACE G-2 section, subordinate units, and attached units (e.g., radio battalion detachment, Marine tactical electronic warfare squadron [VMAQ], tactical electronic reconnaissance processing and evaluation system [TERPES] detachment). The ACI must be sufficiently manned to maintain sustained 24-hour operations. This requires a minimum of two, 12-hour watch crews. Concept of Organization.

Concept of Organization

The overall ACE intelligence effort is organized with a balance between centralization of personnel for collection and analysis to support the ACE as a whole, and decentralization of personnel to support Marine TACC operational elements (future plans, future operations, and current operations). This design concept complements and reinforces the capabilities of the MAGTF as well as subordinate units. Figure 2-11, on page 2-59, depicts the various types of intelligence support provided by the ACE G-2.

ACI is the focal point for intelligence activities within the ACE as well as the hub of aviation intelligence activity within the MAGTF. The ACI is organized to perform all tasks necessary for the completion of the intelligence cycle in order to support ACE operations. These tasks include: planning and direction, collection, processing, exploitation and production, dissemination, and utilization of intelligence.

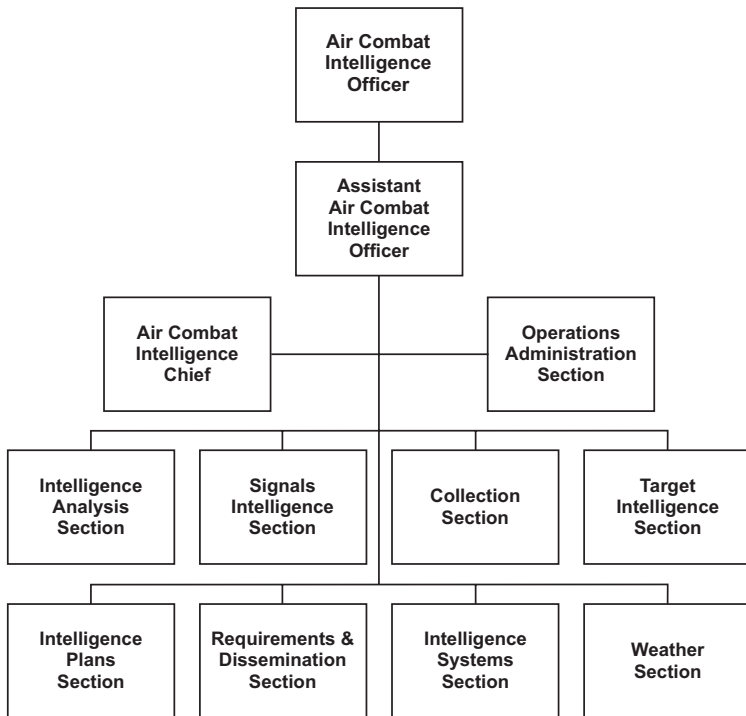

Figure 2-10. Air Combat Intelligence.

This unity of intelligence effort, under the central direction of the ACE G-2, ensures the production and dissemination of fused, timely, and tailored all-source intelligence in support of the ACE. It reduces unnecessary redundancy and duplication of effort. This is especially critical given the finite amount of intelligence resources available within the ACE.

On the other hand, selected intelligence personnel are collocated with future operations and current operations, and with future plans (as required) to provide continuity of support during the

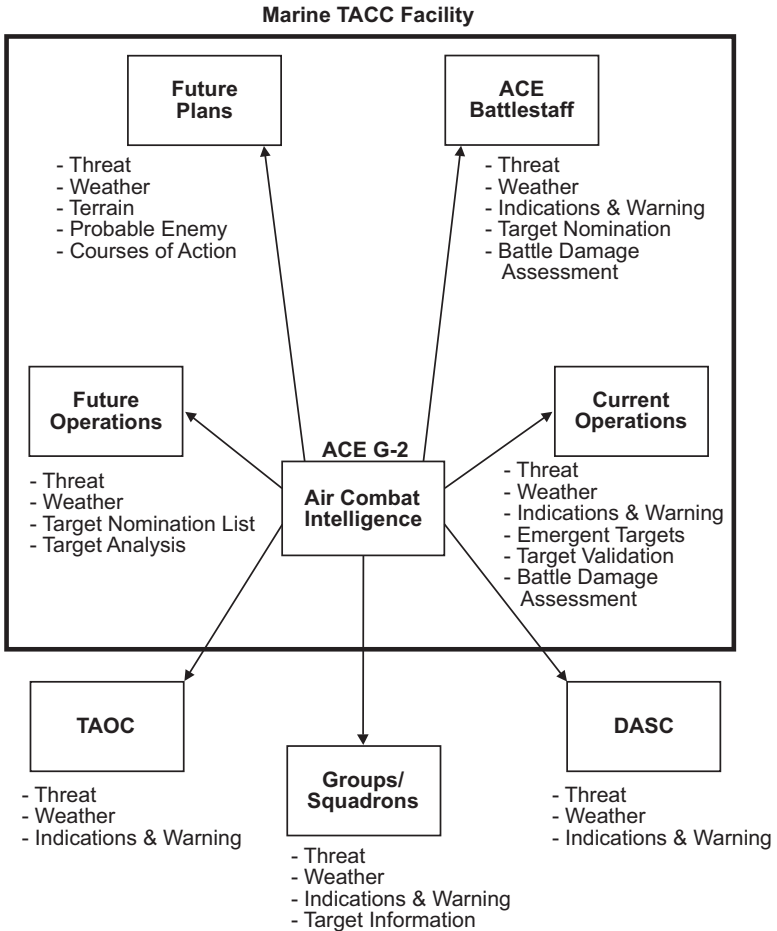

Figure 2-11. ACE G-2 Intelligence Support.

operational cycle. Intelligence representatives are critical to the integrated planning and execution effort as they provide focused

support, drawn from a centralized analysis and production capability, throughout all phases of the operation. They serve as a conduit between their operational cell and ACI.

Mission and Functions

ACI is responsible to the ACE G-2 for producing and disseminating aviation-tailored, all-source intelligence required for decision-making during the planning and execution of MAGTF air operations. ACI extends and compliments the efforts of the MAGTF G-2 all-source fusion center. ACI will—

- Maintain close and continuous liaison with the MAGTF G-2 operations section, the JAOC intelligence division, and other designated intelligence agencies/units as appropriate.
- Prepare ACE intelligence estimates and INTSUMs.
- Direct, coordinate, and supervise the development and forwarding of ACE PIRs and other intelligence requirements.
- Prepare and implement the ACE organic intelligence collection plan including planning and coordinating UAV operations as required.
- Direct, coordinate, and supervise the production and dissemination of all-source intelligence (including target intelligence) to the ACE commander, staff, and subordinate units.
- Direct, coordinate, and determine ACE requirements for maps, charts, graphic aids, and imagery products and supervise appropriate distribution.
- Coordinate intelligence support for ACE survival, evasion, resistance, and escape requirements.
- Arrange and coordinate dissemination of weather data for the ACE.

- Provide the current operations assessment cell with data, information, and/or intelligence, as requested.
- Process mission and pilot reports.
- Perform targeting.
- Interface with functional areas in current and future operations via respective intelligence watch crews.

Billet Descriptions

ACI Officer

The ACI officer is the senior intelligence officer in ACI and is directly responsible to the ACE G-2 for the overall direction and supervision of ACI. The ACI officer will—

- Supervise the preparation and setup of ACI.
- Direct and supervise ACI in the collection, analysis, production, and dissemination of all-source tailored intelligence in support of the ACE commander, staff, and subordinate units.
- Issue threat alerts by the most timely means, consistent with classification (normally a voice or flash INTREP), to units threatened by the enemy action.
- Ensure that the ACE G-2 is informed of—
 - Major changes in the enemy's disposition, composition, capabilities, and/or probable COAs.
 - Any problem that could affect the ability of ACI to accomplish its assigned mission.

MCWP 3-25.4

- Direct the flow of intelligence information within ACI by—
 - Reviewing all incoming intelligence messages to determine internal routing.
 - Ensuring that sections receive and review applicable intelligence messages and take appropriate action in a timely manner.
- Supervise the preparation, review, and release of INTREPs and INTSUMs as directed by the ACE G-2.
- Supervise the preparation, review, and presentation of intelligence briefings as directed by the ACE G-2.
- Ensure all sensitive compartmented information reports and briefings are reviewed and cleared by special security office personnel prior to release.
- Ensure that all ACI maps and displays are accurate and current.
- Ensure that backup procedures are prepared and can be implemented rapidly if automated support systems fail.
- Keep ACI informed of the ACE commander's guidance, intent, and objectives and the ACE G-2's concept of intelligence operations.
- Compile recommended PIRs for the ACE G-2's review. This includes PIRs submitted by future plans, future operations, and current operations.
- Direct and supervise the activities of attached intelligence specialists teams.
- Maintain close and continuous liaison with the MAGTF G-2 operations officer.
- Ensure that communication is maintained with the fixed- and rotary-wing flight line intelligence briefing and debriefing sections.

Assistant ACI Officer

The assistant ACI officer is responsible for the internal functioning of the ACI in accordance with the ACI officer's guidance and direction. The assistant ACI officer will be prepared to assume all the duties of the ACI officer when required.

ACI Chief

The ACI chief is the senior enlisted intelligence specialist in ACI. The ACI chief is responsible to the ACI officer for supervising ACI administrative and supply support. The ACI chief will—

- Assist the ACI officer in the set up of ACI.
- Assist the ACI officer in the production and dissemination of all-source intelligence.
- Receive and separate incoming messages and reports into administrative and operational categories; indicate recommended routing or action; and deliver to the ACI officer for review and routing instructions.
- Function as the ACI secondary control point custodian for classified material.
- Coordinate closely with the ACE intelligence chief on personnel, administrative, supply, and logistic requirements.

ACI Operations Administration Section

The ACI operations administration section is responsible for providing operational and administrative support to ACI. The ACI operations administration section will—

- Maintain the intelligence journal and journal file.
- Maintain ACI files and reference documents.

- Route and deliver incoming and outgoing intelligence messages as directed.
- Provide general administrative support to ACI.
- Function as the intelligence net operator by copying all incoming voice radio traffic in appropriate format, noting originator and time of receipt, and passing to the ACI chief.
- Assist the ACI chief as directed.

Intelligence Analysis Section

The intelligence analysis section is responsible for producing and disseminating all-source intelligence in support of ACE operations. The intelligence analysis section is comprised of an all-source analysis cell, an order of battle cell, and an imagery analysis cell.

Intelligence Analysis Officer

The intelligence analysis officer is responsible to the ACI officer for overseeing the intelligence analysis section. The intelligence analysis officer will—

- Maintain the flow of all-source intelligence information within the intelligence analysis section, ensuring that all reports received are rapidly screened, their significance assessed, and appropriate action taken in a timely manner.
- Supervise the intelligence analysis and production effort, to include preparation of INTREPs and INTSUMs.
- Prioritize, collate, and forward requests for information (RFIs) to the requirements and dissemination section for action.
- Prioritize, collate, and forward collection requirements to the collection section for action.

- Oversee the operations of the intelligence analysis system (IAS) within ACI.
- Maintain a current assessment of the enemy situation and be prepared to brief as required.
- Keep all sections of ACI updated on the current enemy situation as well as probable future enemy COAs.
- Assist the intelligence plans section in the preparation of intelligence estimates for future operations.
- Assist the target intelligence section in the production and maintenance of target folders.
- Present intelligence briefings on the current and future enemy situation as directed.
- Provide intelligence in support of survival, evasion, resistance, and escape to the current operations/RCC and subordinate units.
- Maintain close and continuous liaison with the MAGTF all-source fusion center.
- Inform the ACI officer of major changes in the threat environment.

All-Source Analysis Cell

The all-source analysis cell is responsible for conducting all-source intelligence analysis and production. The all-source analysis cell will—

- Monitor all intelligence sources for time critical intelligence and/or significant changes in enemy operations, tactics, and threats.
- Respond to RFIs and analysis support from other G-2 sections and subordinate units.
- Identify gaps in intelligence holdings and other information needs and submit RFIs and collection requirements to the

intelligence analysis officer for review, consolidation, and forwarding to the appropriate ACI section for action.

- Evaluate, analyze, and interpret all incoming INTREPs to determine the enemy disposition, composition, capabilities, vulnerabilities, and most likely and most dangerous COAs.
- Maintain, from all sources, the intelligence database (manual or automated) on the ACE commander's area of responsibility, influence, and interest.
- Maintain the enemy situation map on the ACE commander's area of operations, influence, and interest.
- Develop aviation-related IPB products.
- Produce INTREPs, INTSUMs, responses to requests for information, updated intelligence estimates, and intelligence briefings.

Order of Battle Cell

Identify high-value targets and pass information to the target intelligence officer for passage to current operations/future operations for attack by ACE assets.

The order of battle cell is responsible for conducting enemy order of battle analysis. The order of battle cell will—

- Ensure the maintenance of enemy air, ground, air defense, and weapons of mass destruction order of battle files.
- Develop and provide the ground, air, air defense, and weapons of mass destruction input for INTREPs and INTSUMs.
- Work closely with the analysts to assist in determining enemy capabilities and vulnerabilities.
- Identify gaps in intelligence holdings and other information needs and submit RFIs to the intelligence analysis officer for review, consolidation, and forwarding to the appropriate ACI section for action.

Imagery Analysis Cell

The imagery analysis cell is responsible for providing imagery interpretation and product support to ACI. The imagery analysis cell will—

- Assist the target development cell in the development of desired mean points of impact for each target.
- Provide imagery interpretation support to the target analysis effort, to include target material production.
- Maintain the ACI imagery library.
- Identify gaps in intelligence holdings and other information needs and submit RFIs to the intelligence analysis officer for review, consolidation, and forwarding to the appropriate ACI section for action.

Signals Intelligence Section

The signals intelligence (SIGINT) section is responsible for providing communications intelligence (COMINT) and electronic intelligence (ELINT) support. The SIGINT section is comprised of a COMINT cell and ELINT cell.

SIGINT Officer

The SIGINT officer is responsible to the ACI officer for overseeing the SIGINT section. The SIGINT officer will—

- Maintain the flow of SIGINT information within the SIGINT section, ensuring that all reports received are rapidly screened, their significance assessed, and appropriate action taken in a timely manner.
- Supervise the SIGINT analysis and production effort, including preparation of COMINT and ELINT summaries as required.

MCWP 3-25.4

- Prioritize, collate, and forward RFIs to the requirements and dissemination section and collection requirements to the collection section for action.
- Ensure the timely dissemination of SIGINT-derived information to the applicable ACI section.
- Assist the collection section in planning and coordinating support from MAGTF, theater, and national SIGINT assets.
- Maintain close and continuous liaison with the MAGTF SIGINT officer.
- Inform the ACI officer of major changes in the threat environment derived from SIGINT.

COMINT Cell

The COMINT cell is responsible for conducting COMINT analysis in support of ACE operations. It will be located in the tactical sensitive compartmented information facility (TSCIF). The COMINT cell will—

- Provide COMINT-based indications and warning including theater missile defense warning.
- Coordinate with G-6 to plan and implement security monitoring to reduce the command's vulnerability to enemy SIGINT activity.
- Assist in the protection of ACE communications from enemy exploitation by conducting communication security surveillance and surveys to determine the success of communications security efforts.
- Identify gaps in intelligence holdings and other information needs and submit RFIs and collection requirements to the

SIGINT officer for review, consolidation, and forwarding to the appropriate ACI section for action.

- Provide COMINT summary reporting to the all-source analysis cell for fusion in determining enemy disposition, composition, capabilities, vulnerabilities, and most likely and most dangerous COAs.
- Coordinate with the target intelligence and intelligence analysis sections to identify potential high value targets for attack by ACE assets.
- Maintain close and continuous liaison with the MAGTF radio battalion to ensure timely exchange of COMINT information.

ELINT Cell

The ELINT cell is responsible for conducting ELINT analysis in support of ACE operations. The ELINT cell will—

- Maintain the electronic order of battle database in the ACE commander's area of responsibility, influence, and interest.
- Process, analyze, and report enemy electromagnetic emissions derived from the various tactical broadcasts as well as from the EA-6B.
- Provide ELINT-based indications and warnings to include theater missile defense warning.
- Provide timely intelligence information in support of ACE electronic warfare (EW) activities.
- Identify gaps in intelligence holdings and other information needs and submit RFIs and collection requirements to the SIGINT officer for review, consolidation, and forwarding to the appropriate ACI section for action.

- Provide ELINT summary reporting to the all-source analysis cell to assist in determining enemy disposition, composition, capabilities, vulnerabilities, and most likely and most dangerous COAs.
- Coordinate with the target intelligence and intelligence analysis sections to identify potential high value targets for attack by ACE assets.
- Maintain close and continuous liaison with VMAQ TERPES detachments to ensure the timely exchange of ELINT information.

Collection Section

The collection section is responsible for receiving ACE collection requirements, formulating detailed collection plans, and tasking/requesting collection assets for the required information.

Collection Officer

The collection officer is responsible to the ACI officer for overseeing the collection section. The collection officer will—

- Receive approved PIRs from the ACI officer, prepare a detailed collection plan, and task organic collection assets and/or request external (e.g., MAGTF, theater, national) collection assets to satisfy the PIRs.
- Manage the processing, validation, and submission imagery intelligence, SIGINT, and human intelligence collection requirements from the ACE staff and subordinate units to the MAGTF.
- Manage all reconnaissance and surveillance assets assigned or made available to the ACE. Maintain awareness of the operational status of organic, MAGTF, theater, and national collection assets, and ensure that the ACI officer is appraised of collector status and capability.

- Maintain the reconnaissance and surveillance status board/log, and maintain displays to include ongoing and planned collection missions.
- Evaluate requirement satisfaction, providing requester feedback, and adjust the collection plan as required.
- Maintain close and continuous liaison with the MAGTF collection section and surveillance and reconnaissance center.
- Inform the ACI officer of all significant developments affecting the intelligence collection effort.

Target Intelligence Section

The target intelligence section is responsible for deliberate and reactive targeting in support of ACE operations including target analysis, target development, target validation, and BDA. The target intelligence cell is comprised of a target development cell, target validation cell, and BDA cell.

Target Intelligence Officer

The target intelligence officer is responsible to the ACI officer for overseeing the target intelligence section. The target intelligence officer will—

- Maintain the flow of target intelligence information within the target intelligence section, ensuring that all reports received are rapidly screened, their significance assessed, and appropriate action taken in a timely manner.
- Approve all targets being nominated to current operations for immediate attack.
- Ensure that all necessary target intelligence support is provided to future operations and current operations as required.

MCWP 3-25.4

- Oversee the operation of the rapid application of air power (RAAP) system and the AFATDS within ACI.
- Provide target intelligence to the ACE in support of deliberate and reactive targeting.
- Prepare the target nomination list (TNL) and submit final nominations to the ACE G-2 for evaluation prior to the ACE targeting board.
- Present ACE target nominations and rationale to the ACE targeting board.
- Plan and coordinate the BDA effort for the ACE.
- Prioritize, collate, and forward RFIs to the requirements and dissemination section and collection requirements to the collection section for action.
- Participate as a member of the combat assessment board convened by the future operations ATO development officer.
- Maintain liaison with the MAGTF G-2 target intelligence section.
- Inform the ACI officer of all significant developments affecting the target intelligence effort.

Target Development Cell

The target development cell is responsible for maintaining the target intelligence database and conducting target analysis in support of ATO production. It works closely with the future operations ATO planning cell. Target development personnel may be

located in ACI or future operations, wherever they can be most effective. The target development cell will—

- Ensure MAGTF target nominations are submitted within the timelines of the established ATO planning cycle.
- Maintain close and continuous liaison with the future operations intelligence watch section and ATO planning cell to ensure timely exchange of target intelligence information required for ATO development.
- Identify gaps in intelligence holdings and other information needs and submit RFIs and collection requirements to the target intelligence officer for review, consolidation, and forwarding to the appropriate ACI section for action.
- Coordinate with the intelligence analysis section to identify potential high-value targets for attack by ACE assets.
- Review all pertinent incoming INTREPs, and maintain the target intelligence database (manual or automated) on the ACE commander's area of responsibility, influence, and interest.
- Coordinate with the intelligence analysis section to conduct detailed analysis of the enemy and area of operations in order to develop a prioritized target list based on the ACE commander's targeting guidance and objectives and after having reviewed ROE and no-attack restrictions.
- Provide target data, to include desired mean point of impact, to the future operations ATO strike planners, and assist in weaponeering targets and developing attack packages. If

appropriate, recommend the sequence and timing of attacks to maximize effects on the enemy.

- Build and maintain target folders.
- Plot all targets validated for attack on the appropriate maps.
- Track the status of target nominations submitted to higher headquarters for sourcing.
- Maintain a record of target nominations for each ATO, annotating each nomination with the targeting rationale and action taken.

Target Validation Cell

The target validation cell is responsible for target validation and refinement for all air missions flown in support of the MAGTF. The cell works closely with the current operations deep battle cell. Target validation personnel may be located in ACI or current operations, wherever they can be most effective. The target validation cell will—

- Maintain the status of targets on the MAGTF prioritized target list and provide target recommendations to the current operations deep battle cell.
- Monitor execution of the current ATO as it pertains to sorties planned against MAGTF nominated targets.
- Monitor current day ATO execution and validate targets at the 8- and 4-hour mark before mission strike, providing target updates to the current operations deep battle cell.
- Identify targets that require immediate reattack before the next ATO and provide the updated target information to the current operations deep battle cell.
- Inform the current operations deep battle cell of significant changes in target priorities and status.

- Maintain close and continuous liaison with the current operations intelligence watch section and deep battle cell to ensure continuous and timely exchange of target intelligence required for ATO validation and refresh.
- Identify gaps in intelligence holdings and other information needs and submit RFIs and collection requirements to the target intelligence officer for review, consolidation, and forwarding to the appropriate ACI section for action.
- Pass lucrative/time-critical target nominations for immediate attack to the current operations intelligence watch section.

Battle Damage Assessment Cell

The BDA cell is responsible for conducting first phase BDA for all air missions flown in support of the MAGTF. The BDA cell will—

- Process mission reports, to determine initial BDA, and query originators for missing, incomplete, or illegible reports.
- Conduct damage assessments of targets struck and maintain cumulative BDA, target status, and estimates of target recuperability. Pass this information, via the target intelligence officer, to the combat assessment board in future operations ATO development.
- Post BDA to the installation or enemy file database.
- Maintain target status information and pass pertinent information to the target development and target validation cells.
- Maintain and analyze the cumulative BDA, target status, and estimates of target recuperability and pass pertinent information to the target development and target validation cells.
- Identify targets that may require immediate attack/reattack before the next ATO and pass the information to the target validation cell.

- Prepare periodic BDA summaries from mission reports.
- Identify gaps in intelligence holdings and other information needs and submit RFIs and collection requirements to the target intelligence officer for review, consolidation, and forwarding to the appropriate ACI section for action.

Intelligence Plans Section

The intelligence plans section is responsible for preparing all intelligence annexes and estimates in support of the ACE planning effort.

Intelligence Plans Officer

The intelligence plans officer is responsible to the ACI officer for overseeing the intelligence plans section and acting as the primary liaison with future plans. The intelligence plans officer will—

- Prepare intelligence annexes for all operations and supporting plans developed by future plans.
- Provide future plans with intelligence updates and estimates throughout the mission planning cycle.
- Produce, collate, and submit all PIRs required by future plans during mission planning.
- Provide the ACE G-2 with periodic COA and mission briefs for upcoming ACE mission changes.
- Provide the future plans officer and senior planner updated intelligence asset availability and status.
- Maintain and update the current and projected enemy situation in future plans.
- Prepare and deliver the intelligence portion of all briefs provided to the ACE commander and ACE battlestaff by future plans.

Requirements and Dissemination Section

The requirements and dissemination section is responsible for processing all RFIs; imagery products; target materials; and geospatial information and services (GI&S) materials from the ACE staff and subordinate units.

Requirements and Dissemination Officer

The requirements and dissemination officer is responsible to the ACI officer for overseeing the requirements and dissemination section. The requirements and dissemination section will—

- Receive, validate, prioritize, and process all requests for intelligence information, imagery products, target materials, and GI&S materials from the ACE staff and subordinate units and ensure—
 - That requests are consolidated, where appropriate, and satisfied from data available within ACI, where possible.
 - That unsatisfied requests are forwarded to higher headquarters for action.
 - The timely dissemination of all replies.
- Maintain the intelligence request log, tracking all RFIs until a response is received, passed to the requester, and declared by the requester to be satisfactory.
- Coordinate with the collection section to satisfy PIRs.
- Coordinate with the ACE G-1 for the distribution of hard-copy products to subordinate units.
- Arrange and coordinate secondary dissemination of imagery to subordinate units.

MCWP 3-25.4

- Manage the command's GI&S program, ensuring the availability of GI&S products to support the ACE staff and subordinate units during all phases of the operation.
- Inform the ACI officer of all time delays in satisfying PIRs or other high priority requests for intelligence.

Intelligence Systems Section

The intelligence systems section is responsible for the day-to-day management of all ACE G-2 automated intelligence systems.

Intelligence Systems Officer

The intelligence systems officer is responsible to the ACI officer for overseeing the intelligence systems section. The intelligence systems officer will—

- Manage all deployed G-2 automated intelligence systems (e.g., IAS, RAAP, and AFATDS).
- Establish and maintain automated connectivity with higher, adjacent, and subordinate units.
- Maintain liaison with the MEF intelligence systems section.
- Inform the ACI officer of computer systems status and problems.

Weather Section

The weather section is responsible for providing weather forecasts and summaries to support current and future ACE operations.

Weather Officer

The weather officer is responsible to the ACI officer for overseeing the weather section. The weather officer will—

- Direct and coordinate the activities of meteorological elements within the ACE.
- Provide tailored, current 96-hour forecasts/summaries to support current and future ACE operations (e.g., weather forecasts, tactical atmospheric summaries, and strike and assault forecasts).
- Prepare electro-optical tactical decision aids for use by the ACE staff and subordinate units, detailing the effects of weather on sensor performance of various weapon systems and platforms.
- Provide timely advisories or warnings of expected weather that may adversely affect ACE operations with an emphasis on significant weather changes at FOBs and en route to and over target areas.
- Provide weather briefs to the ACE commander and staff.
- Coordinate dissemination of weather data within the ACE staff and subordinate units.
- Input weather data into the contingency theater automated planning system as required.
- Inform the ACI officer of any significant weather developments that could impact ACE operations as well as any significant problems in the ACE's meteorological capabilities.
- Maintain connectivity with the joint meteorological office.

Layout

The ACI layout is shown in figure 2-12.

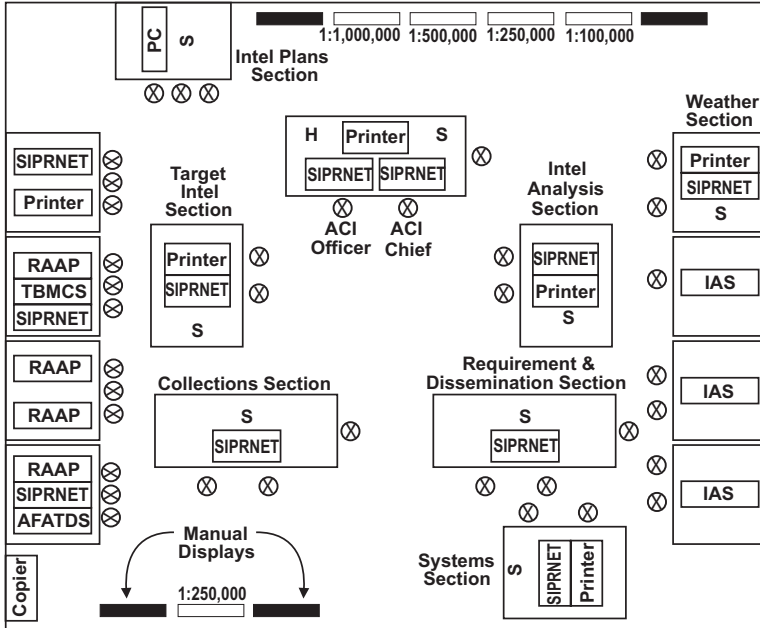

H-hotline
 Intel-intelligence
 PC-personal computer
 S-secure telephone
 SIPRNET-SECRET Internet Protocol Router Network

Figure 2-12. ACI Layout.

The TSCIF compound layout is shown in figure 2-13. The TSCIF is an integral part of ACI operations and must be located in close proximity to ACI.

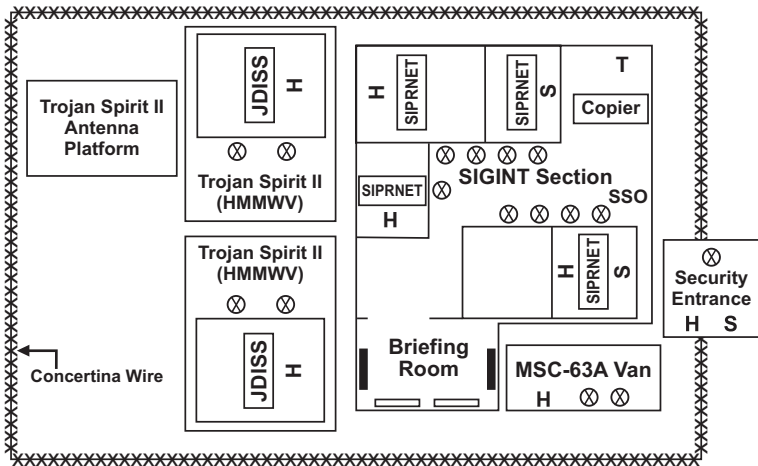

- H - hotline
- HMMWV - high mobility multipurpose wheeled vehicle
- JDISS - joint deployable intelligence support system
- S - secure telephone
- SIPRNET - SECRET Internet Protocol Router Network
- SSO - special security office
- T - tributary

Figure 2-13. TSCIF Compound Layout.

Chapter 3

System Description

This chapter presents the various individual and ancillary Marine TACC components and provides a discussion of their associated capabilities. These components provide the Marine TACC with the requisite equipment and facilities necessary to plan and supervise the employment of MAGTF aviation.

The Marine TACC has undergone extensive design changes since fiscal year 1991 and it has seen the introduction of various systems since 1999. The outcome is a composite system with hardware that integrates portions of the predecessor system, ground common support items, mandated subsystems, and developmental and nondevelopmental items. The resulting system designation is the AN/TYQ-1(V) tactical air command center.

The Marine TACC is a large, composite system that consists of TBMCS; a communications data link system, C2PC, three AN/MRQ-12s; a commander's tactical terminal, three channel (CTT3); a suite of expandable shelters with related furnishings, a collection of commercial off-the-shelf computer equipment, and peripherals that comprise the AN/TYQ-1(V); and a combination of stand-alone C2 and communications distribution system (MESHnet) components.

Theater Battle Management Core Systems

TBMCS provides command and control at all levels and facilitates the planning of the air battle plan (ABP). TBMCS also manages the execution of the ATO and the ACO. TBMCS uses —

- ATO 00 United States Message Text Formatting message format.
- Modernized integrated database (MIDB).
- AODB.
- Web-based utilities (CAOC central).
- DII-COE [defense information infrastructure-common operating environment] standards.

The primary databases associated with TBMCS are the AODB and the MIDB. The AODB contains the friendly order of battle critical to the composition of the ABP and subsequent mission planning. Equally important to mission planning is available airspace that is also contained within the AODB. The database responsible for tracking the enemy order of battle is the MIDB. Target data is built into the MIDB and important to the mission planner for tasking strike missions within the ATO. Imagery is also available in the MIDB.

CAOC Central

The TBMCS CAOC centralized Web environment application is the latest in Web-based access to TBMCS applications and information. CAOC central is not a traditional application, rather an access mechanism to TBMCS application information created and updated by users during the course of operations.

Some of the functions of the CAOC central Web-based application are:

- Provides tabular and graphical displays of data from TBMCS databases.
- Allows users to post files and links to the CAOC central home page for use by other users.
- Refreshes application menus automatically.
- Provides a floating alarm/status bar that is visible in all menus/pages.
- Allows users to change or edit information on the alarm/status bar.

TBMCS Role in the Marine TACC

The main goal of TBMCS in the Marine TACC is two-fold: assist in the centralized planning of the ABP and the decentralized execution of the ATO/ACO. Future operations is responsible for the centralized planning of the ABP. When the ABP is completed, it is then passed on to current operations, which is responsible for decentralized execution. In future plans, the goal is to build the ABP. The TBMCS uses three resources—friendly order of battle, airspace, and the TNI—to build the ABP and eventually generate the ATO. Combat operations monitor mission and AODB status.

Intelligence is supported by TBMCS through imagery management (IM), intelligence data management (IDM), targeting and weaponeering module (TWM), and situation awareness and assessment (SAA). IM permits access to the imagery database and servers, thus enabling the development of targets. The IDM provides intelligence with an interface to the MIDB. TWM is responsible for building the TNL. The TNL is as essential as

MCWP 3-25.4

airspace to the mission planner, without it ground target missions would be nonexistent.

Future operations in TBMCS is driven by the theater air planner (TAP) and airspace deconfliction (AD) applications. TAP is utilized to build the friendly order of battle and ATO. With airspace, friendly order of battle, and TNL, the ABP has the necessary information required to plan missions and generate an ATO. Airspace is required in tasking any mission requiring an air location. AD is responsible for building new airspace and deconflicting existing airspace.

Current operations in TBMCS are accomplished via execution management control (EMC), execution management replanner (EMR), SAA, and execution management (EM) reports. EMC monitors mission status and current status of the AODB. EMC also allows units to update and maintain the AODB on items like landing and take-off times, munitions usage, and mission aborts. EMR is used to replan missions and make and publish changes to the current ATO. Finally, EM reports are capable of generating reports on the current ABP. Mission status and resource availability information is presented via EM reports. Reports generated are compatible with standard computer programs and can be used to build briefs on current mission status.

Applications and the ATO Cycle

During the target development of the ATO cycle, IM, IDM, TWB, and SAA are applied. The primary application associated with weaponeering and allocation is TWB, which produces the TNL to be imported by TAP. The TAP and AD are the main tools

used during the ATO development process. Force execution employs EMC, EMR, SAA, and EM reports for continuity throughout the ABP execution. Lastly, combat assessment is accomplished with the support of IM, IDM, TWMM, SAA, and EM reports to provide the most relevant information for planning the next days ABP.

Communications Data Link System

The communications data link system (fig. 3-1 on page 3-6) is a component item of the Marine TACC AN/TYQ-1(V). It is a modular suite of commercial and government off-the-shelf computer and communications equipment that is stored and transported in Department of Defense-approved cases or a lightweight multipurpose shelter mounted on a heavy, high mobility multipurpose wheeled vehicle. The communications data link system provides the Marine TACC automatic and operator-assisted data correlation functions. It processes information from multiple information sources to produce a single integrated air picture and manages dissemination of the resultant picture to users in the required format in near real time to both operations and intelligence elements. The communications data link system communicates by means of TADIL A, TADIL B, TADIL J, Link-1, and joint range extension. When linked to the commander's tactical terminal, it provides a satellite receive/transmit capability that allows the commander to respond to intelligence data from the integrated broadcast service. Communications data link system operates as a certified special information system and has tactical reporting responsibility.

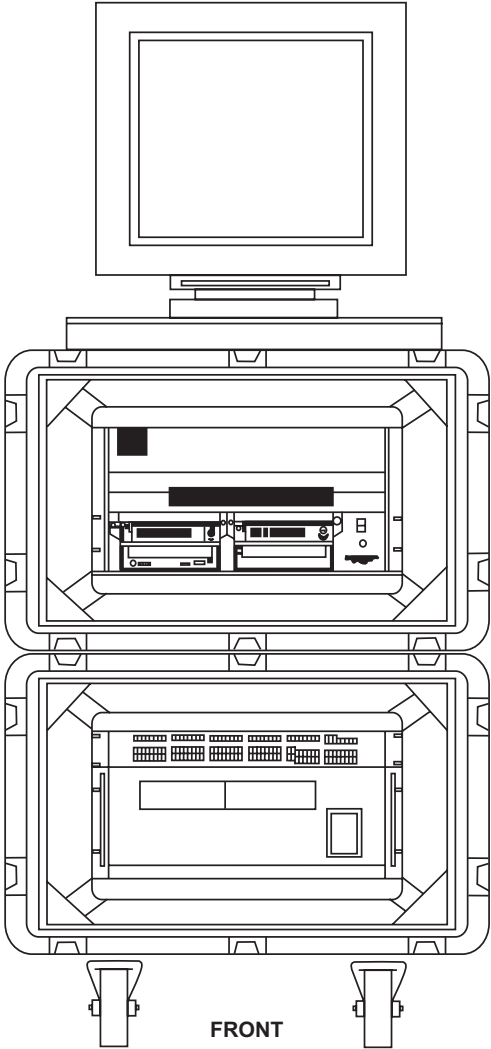

Figure 3-1. Communications Data Link System.

C2PC

C2PC is a standard software application designed to facilitate military C2 functions. Used as a standalone tool, trained C2PC operators can produce overlays and operational graphics for a unit's internal use. When connected to a computer network, C2PC has the capability of depicting the current locations of the friendly and enemy units that have been inputted into a tactical database, as well as instantly share overlays and message traffic. With this electronic connectivity, C2PC becomes a powerful tool for the commander, providing a common tactical picture throughout the command.

AN/MRQ-12

The AN/MRQ-12 (see fig. 3-2 on page 3-8) is the single-shelter configuration of the five-shelter AN/TSQ-207, high mobility downsized DASC. The nomenclature for a one-shelter configuration has yet to be determined. Each AN/MRQ-12 provides rack space, antennas, as well as signal and power distribution for the very high frequency (VHF), ultrahigh frequency (UHF), high frequency (HF), telephone, and requisite encryption assets organic to the MTACS.

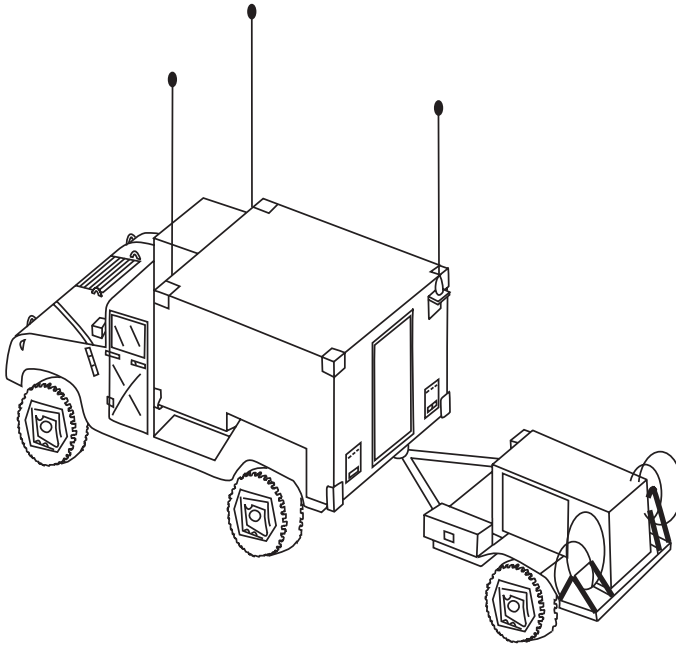

Figure 3-2. AN/MRQ-12.

The C3D system for the AN/MRQ-12 is comprised of a system called MESHnet, which allows the operator to interface the following items:

- User control device that allows the operator access to the radios, intercom, and telephone. With the user control device, the operator can monitor four nets at one time and remotely switch cryptographic devices on and off.

- Network access unit is the heart of the MESHnet. It routes traffic among user control devices and interfaces with radios, telephones, and an Ethernet computer network.
- Ethernet interface unit connects the Ethernet local area network on which the AN/MRQ-12 automation equipment resides with the network access unit.

MESHnet components within the Marine TACC's AN/MRQ-12s are used to remote the required radio and telephone nets to the Marine TACC. This is done when a corresponding divorced set of MESHnet components is employed to distribute communications operator stations located throughout the shelter suite. The Marine TACC is equipped with three AN/MRQ-12s that replace the two OE-334 (antenna coupler groups) and AN/TYA-16C (communications group).

Commander's Tactical Terminal

Three-Channel

The CTT3 is a three-channel, UHF satellite communications (SATCOM) and line-of-sight intelligence broadcast receiver. The CTT3 provides the Marine TACC with near-real-time intelligence data from the tactical reconnaissance intelligence exchange system network, the tactical information broadcast server network, the tactical data dissemination system broadcast, and the onboard processing and direct down-link broadcast. The CTT3 transmit capability enables the commander to respond to Integrated Broadcast Service.

MCWP 3-25.4

The CTT3 is a ruggedized terminal that provides the user with a simultaneous, full-duplex single channel and two, receive-only channels for processing various data streams from joint, Service, tactical, and national intelligence dissemination networks. This input provides the Marine TACC with additional tools to perform rapid targeting, threat avoidance, battle management, and mission planning. The CTT3 is transported in, and operated from, two identical transit cases. A third transit case is provided for accessories. Antennas are transported separately.

Shelter Suite

The MTACS may or may not be responsible for providing shelter assets for future plans, ACI, or the sensitive compartment information facility. This layout facilitates, through collocation, the requirement to cross-functionally interact across the operational and intelligence continuum. Approximately 6,000 square feet are required to house the Marine TACC facility. Due to the requirements for expediency in setup, deployment size, expandability, and system environmental controls (air quality and temperature), the preferred sheltering option would be to house the Marine TACC equipment in an existing (hard) structure (e.g., hangar, warehouse, gymnasium). A second option is to use deployable, rigid, environmentally-controlled structures. Tentage would be the least desirable option.

The Marine TACC shelter suite consists of six 3-1, International Organization for Standardization (ISO) shelters; two modular extendable rigid wall shelters (MERWSs); six S-835/G, shelter kit passageways; a customized power distribution system; and a collection of tables and chairs used inside the shelter suite.

Figure 3-3 depicts the Marine TACC setup using shelters and ancillary equipment organic to the MTACS. When set up in these shelters, assets organic to the MTACS provide climate control and power to the shelter suite. The shelter suite also has an inter-shelter blackout capability for overall light discipline.

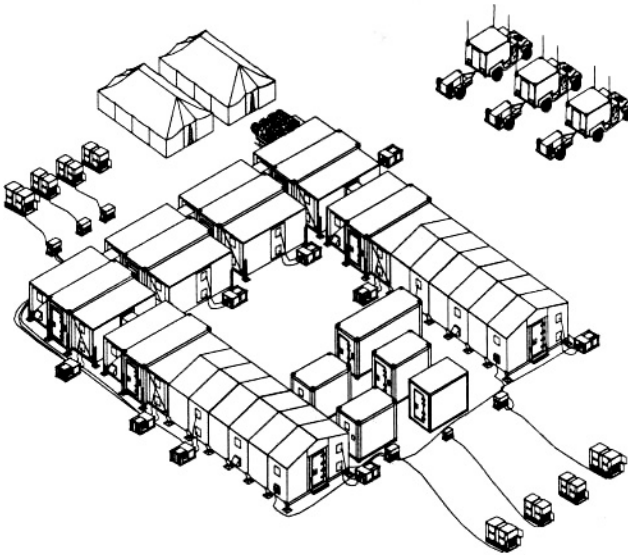

**Figure 3-3. Marine TACC Setup
Using Organic Shelters.**

The cornerstones of the shelter suite are the 3-1 and the MERWS enclosures. Storage during embarkation for all components of the shelter suite, with the exception of the power distribution system, is within the 3-1 shelters.

Base-X Shelter

The Base-X Shelter System is an advanced, lightweight, rapid deploying tactical shelter. The folding frame design gives the system its strength and its rapid setup capabilities. Performance is achieved while keeping the system to a minimum weight and size when packed, making it more mobile and easier to embark. During setup and takedown, the liner is quickly connected and disconnected from the frame offering the user many advantages. Most apparent of these advantages is the ability to split the system into smaller more mobile packages that allows the integrated equipment to remain installed and easy access of frame components for maintenance and repair.

3-1 ISO Shelter

The 3-1 is the 100-ampere, 3-phase, 5-wire, 120/208 volts, alternating current (VAC) variant of the Army standard family of expandable rigid wall shelters. There are six modified 3-1 shelters in the shelter suite. Each of the 3-1s is a standard 8- by 8- by 20-foot expandable ISO shelter. The 3-1 can expand from both sides to form a 21.75- by 8- by 19.85-foot enclosure that provides roughly 400 square feet of open interior floor space (see fig. 3-4). All the 3-1 shelters have modifications that accept attachment to a MERWS, although the shelter suite only uses two in this capacity at any given time. The modified 3-1 has six close-out panel openings that, although populated, are capable of being removed or configured to accept either the 3-1 passageways, ECU supply or

return panels, power input or output panels, or blank panels. The 3-1 has a blackout relay that not only controls the overhead lighting within the 3-1 but is also capable of linking to an adjacent 3-1 or MERWS blackout relay.

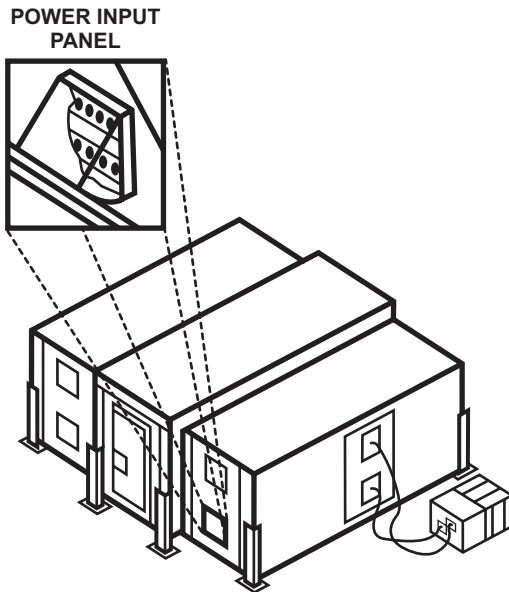

Figure 3-4. 3-1 ISO Shelter.

Modular Extendable Rigid Wall Shelter

The MERWS is a lightweight, knockdown kit designed for attachment to any of the Army standard family of extendable rigid wall shelters. The MERWS attaches to a modified 3-1 in the shelter suite configuration. The shelter kit attaches to the extendable side-wall opening of the 3-1. The lateral walls of a modified 3-1 expand out, one lateral wall separates them, an adapter kit attaches to the resulting 8- by 20-foot opening, and a sequence of repetitive modules is then erected end to end (see fig. 3-5). The kit also breaks down to individual components (e.g., panels, base-frame pieces, roof trusses) and packs within the 3-1 for transport.

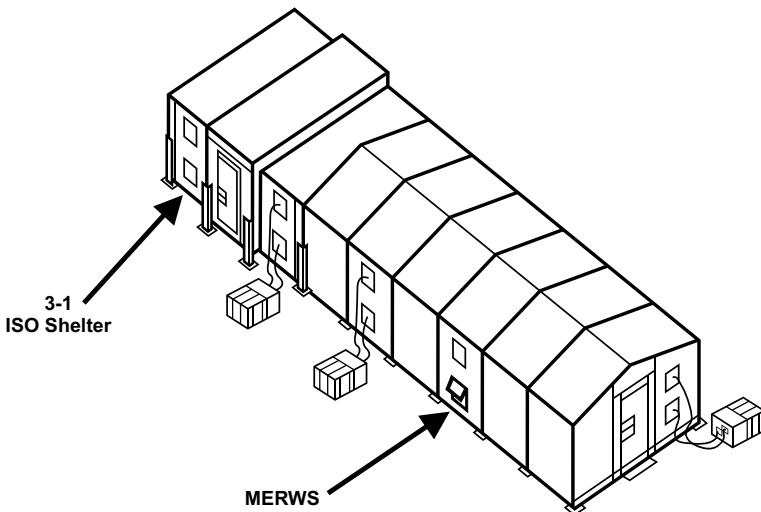

Figure 3-5. Modular Extendable Rigid Wall Shelter.

The 3-1 has modifications that facilitate MERWS kit attachment and stowage for shipment. The resulting structure provides roughly 1,150 square feet of unobstructed floor space. The MERWS can be unpacked and erected by four Marines in 4 hours. The MERWS features fluorescent lighting; 3-phase, 5-wire, 120/208 VAC, 100-ampere power; leveling jacks; and interchangeable panels for ease and flexibility of configuration. Due to its insulating qualities, the MERWS facilitates efficient heating and cooling. In the shelter suite configuration, the MERWS has a complement of two B0011 air conditioners. Of the 14 wall panels that comprise the MERWS, 5 accept 16-inch diameter ECU ducts. The complement of five wall panels with ECU ducts facilitates the use of additional air conditioners during extreme climatic conditions. The inclusion of fabric air ducts attached to the ECU internal intake and return vents further aid the heating and cooling process. The positions of the ducts traverse the length of the MERWS via the overhead roof trusses.

The S-835/G is a collapsible passageway that enables the shelter suite to adjoin its 3-1 shelters. A 58.5- by 77-inch close-out panel is removed prior to installing the shelter kit passageway. The hinged frame of the S-835/G expands in the opening with a coated polyester fabric attached. There is a 6-foot wide ramp with each S-835/G to allow movement between the 3-1s (see fig. 3-6 on page 3-16). The S-835/Gs enable movement from one shelter to another without being exposed to the elements. The S-835/Gs are collapsed when not in use and transported in one or more of the 3-1s. Six S-835/Gs are in the shelter suite.

Marine Corps Expeditionary Shelter System

The Marine Corps Expeditionary Shelter System (MCESS) is a family of standardized containers that are complexable and

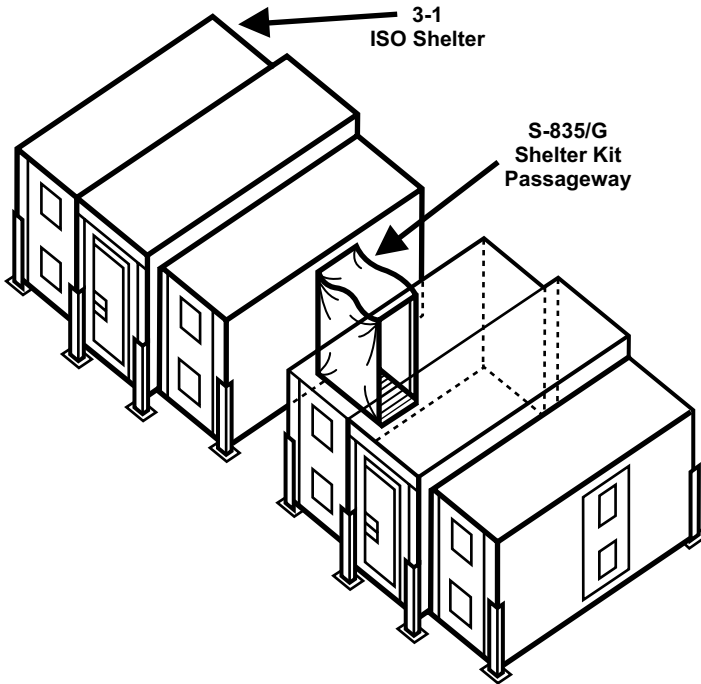

Figure 3-6. S-835/G Shelter Kit Passageway.

designed to fit the user's needs. Adjoining corridors link the MCESS systems, which provides a weathertight seal. Containers are rough terrain container handler transportable and can be lifted by helicopter.

Rigid MCESS

The rigid MCESS is a standard 10- and 20-foot container. Most MTACSs have four 10-foot and three 20-foot rigid MCESSs.

Each MCESS has removable sidewalls that enable a connection and interface with other MCESS units. The electromagnetic interface version does not have removable walls, but it may still be attached to other units through the use of adjoining corridors.

Knockdown MCESS

The knockdown MCESS is a standard 20-foot container with removable sidewalls facilitating connection and interface with other units. If heavy equipment is not available, the structure can be constructed by hand in 30 minutes.

Nonorganic Shelter Options

Shelters not organic to the MTACS may be used to house the Marine TACC. These shelters could include maintenance tents, clamshell shelters, and K-span shelters. When these alternate shelter options are used, the MTACS may not possess adequate organic equipment and personnel to support the use of the structure. Augmentation in the form of engineer, environmental control, and electric power personnel and equipment may be required.

Maintenance Tent (Canvas and Metal Frame)

Similar to a general purpose tent, the maintenance tent does not provide a clean environment for Marine TACC automated equipment.

Clamshell Shelter (Fabric and Frame)

The clamshell shelter is a durable, civilian-built tent with an A-frame system covered with high-grade fabric. There are eight clamshell shelters embarked on maritime prepositioning force ships. These shelters are the 50A-BBA-7CC series. They can completely enclose

MCWP 3-25.4

the Marine TACC environment (dust free). The clamshell shelter can be relocated and constructed easily.

K-Span Shelter (Rolled Steel and Expeditionary Structure)

The K-Span is a steel building constructed on site using one machine for seam sealing. A concrete foundation is constructed below the shelter. The K-Span is expeditionary, inexpensive, and quick to assemble (after the site is prepared). It can be de-seamed for repacking.

Power Distribution System

The power distribution system portion of the shelter suite uses selected components of the Marine Corps P-100 power distribution system to facilitate delivery and distribution of power. The delivery and distribution of electric power are from MEP generator assets of the MTACS (i.e., MEP-803A, MEP-006A, and MEP-007As) via the power distribution system panels to the S-786/Gs, MERWS, air conditioners, and other select components of the Marine TACC.

Cable Sets, Reels, and Pallets

Cable sets, reels, and pallets are used to transport, interconnect, and distribute power among the various Marine TACC shelters. Cable sets consist of signal and power cables required to apply power to the system and exchange voice and data with other equipment and C2 agencies. Cable reels are used to carry individual cables during transport.

Ancillary Equipment

Power Equipment

The Marine TACC uses organic, MEP generators, ranging from 30 to 100 kilowatts, for its power requirements.

Environmental Control Units

The Marine TACC uses 60 hertz air conditioning units ranging from 18,000 to 60,000 British thermal units capacity to regulate the temperature within various Marine TACC components.

System Limitations

Data Link Dependency

Marine TACC displays depend on automated input from other sensor-equipped, data link-capable agencies. Information from agencies is normally based on their radar picture, which may be subject to line-of-sight limitations. Airborne early warning aircraft and advances in technology assist in overcoming shortfalls in presenting a complete air situation. In addition, establishing data links with multiple data link-capable units will provide an expanded, redundant air situation presentation.

Vulnerability to Electronic Detection

The Marine TACC has a large electronic signature generated by its vast data and voice communications equipment. Effective

planning and employing dispersion techniques and emission control measures maximize the Marine TACC's survivability.

Lack of Mobility

The MTACS does not have the organic assets needed to support the movement of Marine TACC equipment. MTACS external support requirements include materials handling equipment and motor transportation augmentation.

Equipment Upgrades and Replacements

Advanced Field Artillery Tactical Data System

The AFATDS is an automated fire support C2 system. AFATDS automates the fire planning, tactical fire direction, and fire support coordination required to support maneuver from the sea and subsequent operations ashore. The AFATDS will be used at fire support and air control agencies from firing battery to the command elements of the MAGTF and the joint task force (JTF).

The AFATDS workstation is the main system component of AFATDS and will receive, transmit, edit, display, and process fire support requests, and store data to facilitate artillery fire support direction and coordination. A full range of fire support, maneuver control, coordination measures, and geometry are displayed for fire support coordination at the workstation. AFATDS operates within the existing and planned communication architecture and assists the commander with automated message delivery for coordination of supporting arms fires. The latest version possesses a laptop capability and employs version 6.3.2.0.B (Marine Corps standard).

Tactical Electronic Reconnaissance Processing and Evaluation System

TERPES will provide the capability to identify and locate enemy radar emitters from data recorded by EA-6B aircraft and received from other intelligence sources. TERPES processes near-real-time data link information and recorded EA-6B data.

Common Aviation Command and Control System

The Common Aviation Command and Control System (CAC2S) will modernize the capability of the MACCS to support the planning and execution of aviation operations for the MAGTF. The CAC2S acquisition represents a modernization effort that will serve to remedy the operational, technical, and logistical deficiencies of the existing MACCS by replacing those legacy systems with a common suite of equipment. The CAC2S will not replace air defense weapons, radios, or sensors organic to the MACCS. The CAC2S will allow for the consolidation of the existing functionality of legacy MACCS systems into a single system capable of performing those various functions with a common suite of equipment and software applications.

The CAC2S will provide operators with planning and execution capabilities for aviation operations that will interface with legacy MACCS systems, current MAGTF C2 systems, jointly mandated systems, and future joint and MAGTF C2 systems. The system will allow operators to execute current operations while simultaneously conducting planning for future operations. The primary intent of the CAC2S is to ensure that the MACCS is capable of supporting MAGTF operations in both current and emerging operational environments.

MCWP 3-25.4

The CAC2S will consist of tactical shelters, hardware, and software with the objective of significantly reducing the logistical footprint of the existing MACCS equipment suites. The hardware components will be modular and man portable in transit cases. The hardware components, mounted in transit cases, may be either free standing or rack mounted in a tactical or fixed shelter, or rack mounted in a shelter that is transported by a high mobility multipurpose wheeled vehicle.

The CAC2S, as a component of a family of systems, provides the C2 system for the MACCS of the 21st century. The CAC2S is expected to be provided sensor support from either independent sensors, such as the AN/TPS-59 and ground/air tasked-oriented radar, or sensor networks providing precise composite tracks such as the Composite Tracking Network. The CAC2S will provide the command and control of air and surface engagements by weapons to include the Complementary Low Altitude Weapons System.

The CAC2S will incrementally replace a majority of the MACCS' current C2 suites of equipment of the MACCS, combining new technology and processes to translate the MAGTF commander's intent into aviation-specific missions and tasks while retaining backwards compatibility with legacy systems. Those items that will not be replaced by CAC2S include the active sensors, air defense weapons, and existing communications assets organic to the MACCS. Utilizing an evolutionary acquisition approach, CAC2S will be fielded incrementally to replace the functions resident in the following MACCS agencies and units of 2007:

- Increment 1:
 - TAOC.
 - SADF.

- Early warning/control (EW/C).
- Low altitude air defense battalion and battery combat operations centers.
- Increment 2:
 - Marine TACC.
 - DASC.
 - DASC (airborne).
- Increment 3:
 - Marine air traffic control detachment.

The MAGTF will realize an increase in capabilities with CAC2S over current equipment and functionality of the MACCS. CAC2S will improve MAGTF operational capabilities in the following areas:

- **Deployability.** The CAC2S operational and logistic footprint will be a fraction of that required for the bulky hardware suites and ground support equipment of today's MACCS. Modularity and equipment commonality will eliminate the need for large, dissimilar shelter systems and their accompanying specialized maintenance support. Developed with a tactical focus for expeditionary maneuver warfare operations, CAC2S equipment will provide both rapid deployment and rapid employment capability.
- **Flexibility.** Beyond embarkation improvements and reduced footprint, CAC2S provides increased flexibility to aviation command and control in maneuver warfare. The CAC2S enables mission planners to combine aviation C2 functions within a single node and to add nodes to satisfy the mission requirements and changing tactical situation. Planners may

distribute MACCS functions across an interoperable network or centralize them at a particular node. The MAGTF CAC2S users will employ adaptable, decentralized networks instead of relying on a linear, centralized information hub for the distribution of a common operational picture, common tactical picture, air picture, and status of air missions. The employment of stove-piped aviation C2 agencies in single-function facilities will be replaced with shared, decentralized, open architecture communications system suites. Small, mobile C2 nodes will provide new employment options for the MAGTF, even for Marine expeditionary unit (MEU)-sized forces where, traditionally, access to the air picture is extremely limited after disembarking from the ships of the amphibious ready group. The CAC2S will use shared, distributed information systems and common databases to enhance rapid, flexible planning and execution for assault forces en route to the objective while supporting headquarters not yet deployed in a reachback posture.

- **Manpower and Training.** The CAC2S will facilitate a gradual shift in manpower and training away from highly focused, single-function specialties into broader skill areas. Additionally, CAC2S will lessen logistic support requirements.
- **Adaptability.** Aviation C2 functions will be able to adapt to a MAGTF C2 environment that requires the capability to operate afloat, ashore, airborne, and during the transition phase to the objective.
- **Connectivity.** The CAC2S will provide the MAGTF commander connectivity to the joint communications system command information architecture throughout the battlespace.

Chapter 4 Planning

Marine aviation planners facilitate and optimize the use of ACE assets to provide a means for responsive and effective air operations. The ACE planners must be knowledgeable of ACE asset employment considerations to execute the six functions of Marine aviation. These considerations are collectively applied when developing a cohesive aviation plan to support MAGTF operations. Marine Corps Warfighting Publication (MCWP) 5-11.1, *MAGTF Aviation Planning*, and Marine Corps Reference Publication (MCRP) 5-11.1A, *MAGTF Aviation Planning Documents*, address additional considerations for employing the ACE.

Marine TACC personnel provide the MAGTF with responsive air support in a complex and dynamic environment. To plan air operations effectively, Marine TACC personnel must understand the Marine Corps Planning Process (MCP) and the MAGTF's PDE&A cycle. When the MAGTF is operating as part of a joint force, they must also understand the joint air planning and execution process, and how it interfaces with the MAGTF. When the MAGTF is operating in a joint environment, all air operations must be coordinated and deconflicted with the air capable components of the joint force.

The Marine TACC PDE&A cycle, used to support MAGTF air operations, is continuous from receipt of a mission until the termination of the operation. The Marine TACC PDE&A cycle is driven by several interrelated processes: the MCP, the ATO cycle, the targeting planning cycle, and the intelligence planning cycle (see fig. 4-1 on page 4-2).

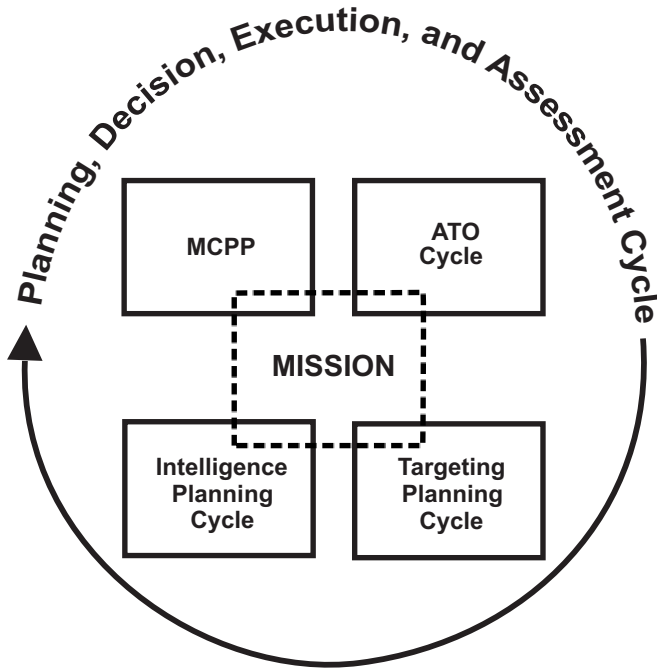

Figure 4-1. PDE&A Cycle.

Aviation planning within the MAGTF is a continuous process that takes into account the current situation, previous actions, and future requirements. The ACE is actively involved in the air planning process at three levels: the ACE, the MAGTF CE, and the joint force headquarters.

At the ACE level, ACE planners initiate the planning process to develop requisite OPORDs upon receipt of mission tasking by the MAGTF. During each day of the operation, the ACE is involved

in evaluating the previous day's ATO, executing the current day's ATO, developing the next day's ATO, and planning the ATO for 2 days in advance.

At the MAGTF CE level, the ACE provides assistance to the MAGTF G-3 air section by completing necessary aviation planning actions. The G-3 air officer and his staff interface between the MAGTF commander and the ACE battlestaff at the Marine TACC. They provide the MAGTF commander with aviation expertise at the command level. The presence and assistance of the G-3 air officer allows the MAGTF commander to develop his plans with a thorough understanding of aviation capabilities and limitations. The staff functions of the G-3 air officer and his staff do not circumvent the command relationship between the MAGTF commander and the ACE commander nor do they replace or duplicate the functions of the Marine TACC.

At the joint or multinational headquarters level, the ACE planners must coordinate and deconflict MAGTF air operations with the other air capable components of the joint force. The ACE's planning effort is kept on track by a common understanding of the mission and the commander's intent (part of every mission) two levels above and through liaison among the ACE staff, the MAGTF staff, and Marine LNOs at the JAOC.

Detailed planning with the combined force air component commander/JFACC should be completed prior to any operation or exercise to ensure all parties understand and agree upon the utilization of MAGTF aviation assets. This includes command, control, and communications agencies as well as organic Marine Corps aviation assets. This initial planning is critical as it will ensure all parties understand the applicable tasking process and associated command relationships.

MCWP 3-25.4

Aviation planning is not the exclusive domain of the MAGTF and ACE commanders. The GCE and the LCE provide vital input into the aviation planning process. As GCE and LCE commanders conduct their own planning, they address aviation requirements and submit requests for aviation support to the MAGTF commander, who considers them for inclusion in the ACE operations or FRAGO.

The ACE staff's operational planning begins upon receipt of the mission (warning order) from the MAGTF commander. The ACE commander will analyze the mission and issue initial planning guidance to start the planning process. The air operations planning process is characterized by long- and near-term planning efforts.

Long-Term Planning

This portion of the planning phase is predominantly conducted by the Marine TACC's future plans. Future plans concentrates on aviation operations that will occur beyond the next ACE mission change, looking at macro-level air operations planning, based on the MAGTF and ACE commanders' initial planning guidance and stated objectives. Future plans develops the initial plan and estimates for MAGTF air operations in support of the assigned mission and creates the ACE support plan. The ACE support plan is transitioned to the OPT for OPORD or FRAGO detailed preparation. The Marine TACC's future operations forms the nucleus of the OPT (fig. 4-2).

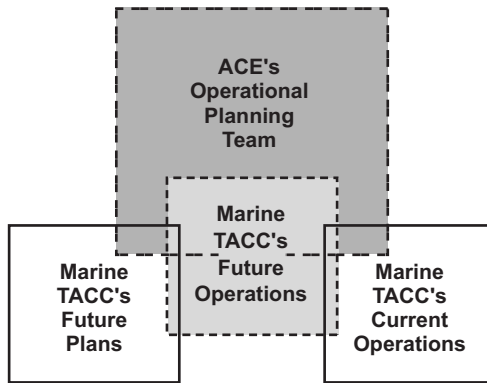

Figure 4-2. Ace Operational Planning Team.

Near-Term Planning

Near-term planning is conducted by the Marine TACC's future operations. Future operations is responsible for developing air operations plans until the next ACE mission change, based on guidance received from the ACE commander. This plan is structured to follow the framework of the long-term plan previously developed by the Marine TACC's future plans. Future operations takes the ACE support plan, developed by future plans, and forms an OPT (directed by the future operations orders development officer) to develop ACE OPORDs or FRAGOs and conduct current planning for aviation events that occur beyond the ATO

MCWP 3-25.4

being planned but short of the next FRAGO being developed. Future operations also develops an apportionment recommendation for the ACE commander. The ACE commander either concurs with the recommendation or modifies it and presents an apportionment recommendation to the MAGTF commander.

The MAGTF commander then makes an apportionment decision by approving or modifying the ACE commander's recommendation. Future operations takes the apportionment decision, collects input from supported units within the MAGTF, and integrates pre-planned requests for support (e.g., JTARs, ASRs) into the ATO. The ATO construction and dissemination culminate the near-term planning efforts.

Marine Corps Planning Process

The operational planning continuum starts for the ACE upon receipt of a mission or mission change from higher headquarters. It parallels the MAGTF planning process (see fig. 4-3). The ACE is key in the development of the MAGTF OPOD or FRAGO so it follows the same MCPP procedures as the MAGTF in its initial OPLAN development.

MAGTF planning is accomplished by the G-5 and G-3 planning teams. The ACE planning is done by the ACE staff under the cognizance of the ACE G-3 and the Marine TACC's future operations and future plans. The MAGTF G-5 future plans focuses on new missions for the force. The ACE staff coordinates with the MAGTF G-5 to receive input regarding ACE support for new MAGTF missions or mission changes. The Marine TACC's future plans will take this input and produce ACE estimates of supportability and support plans for the mission change. The MAGTF G-3 future

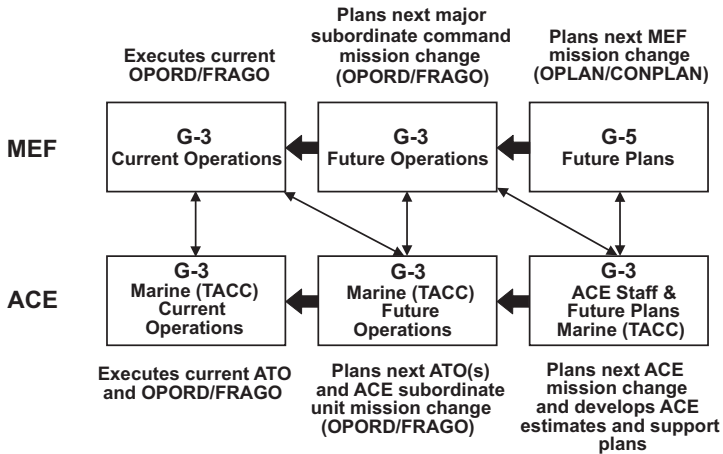

Figure 4-3. MEF/ACE Planning Interaction.

operations focuses on producing new FRAGOs to support changes to the mission for MSCs and leads the integrated planning effort. The Marine TACC’s future operations coordinates with the MAGTF G-3 future operations to receive input for development of the ACE OPORD or FRAGO. The MAGTF G-3 current operations executes the plan and assesses its effectiveness. The Marine TACC’s current operations will coordinate with the MAGTF G-3 current operations to receive input regarding immediate requests requiring alteration of the current ATO. The Marine TACC’s future operations will also coordinate with the MAGTF G-3 current operations to receive requirements that need to be sourced in the next ATO. Operational planning is a continuous process from the receipt of a mission to termination of the operation. It requires extensive coordination between the ACE and MAGTF planning staffs.

MAGTF operations are planned using the six-step MCPP. The MCPP (see fig. 4-4 on page 4-8) provides a logical and orderly

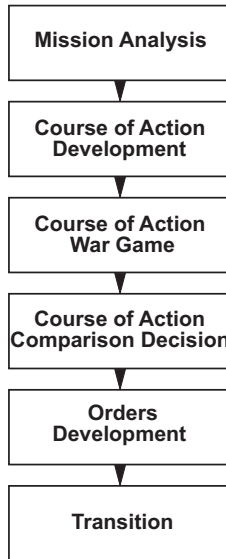

Figure 4-4. Marine Corps Planning Process.

method to plan operations. Each successive step in the process is linked. The output from one step becomes the input for the next. The MCPP breaks the total planning process into more manageable portions for the commander and his staff. The three tenets that guide the MCPP are—

- **Top-Down Planning.** Top-down planning ensures that the commander is driving the planning process which, in turn, provides common direction and unity of effort.
- **The Single-Battle Concept.** The single-battle concept focuses the efforts of all MAGTF elements to accomplish the mission.
- **Integrated Planning.** Integrated planning uses the six war-fighting functions (i.e., maneuver, intelligence, fires, logistics,

command and control, and force protection) as the foundation for plan development.

Aviation Planning Products

As the MAGTF begins detailed planning for the operation, the ACE task-organizes to provide and establish aviation support and command and control on order. Throughout the MCPP, ACE planners fulfill MAGTF planning requirements by creating specific aviation planning products (i.e., initial estimate of aviation support requirements, aviation estimate of supportability, detailed estimate of aviation support requirements, aviation concept of operations, and aviation documents). These aviation planning products are provided by the ACE to the MAGTF commander to support the MAGTF OPT planning effort. Figure 4-5, on page 4-10, depicts where, in the MAGTF planning effort, specific aviation planning products are required as well as the Marine TACC staff responsible for their development.

Initial Estimate of Aviation Requirements

The Marine TACC future plans prepares an initial estimate of aviation requirements as soon as preliminary information about the assigned mission or operation is available. The initial estimate is presented to the MAGTF commander during the MAGTF OPT mission analysis step. The estimate may include only the number and type of aircraft and C2 agencies required. The initial estimate is deduced from the ACE estimates of enemy aviation capabilities and the general mission of the MAGTF.

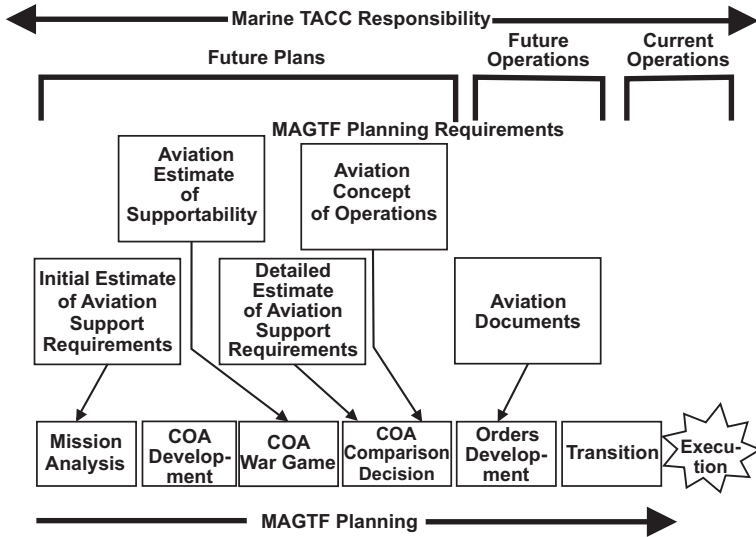

Figure 4-5. Aviation Planning Products.

Aviation Estimate of Supportability

The Marine TACC future plans completes a supportability estimate, which summarizes significant aviation-related aspects of the situation as they might influence any COAs proposed. It also evaluates how aviation assets can be best employed to support these COAs. The aviation estimate of supportability is provided to the MAGTF commander prior to the MAGTF OPT COA comparison and decision step. At a minimum, the aviation estimate of supportability—

- Provides the COAs that can best be supported by the ACE.
- Outlines advantages and disadvantages of possible COAs.

- Identifies significant aviation limitations and/or problems of an operational or logistical nature.
- Highlights measures that can be taken to resolve existing aviation problems including requesting additional theater assets.

Detailed Estimate of Aviation Support Requirements

Detailed planning of ACE requirements commences after the MAGTF commander issues the concept of operations. The Marine TACC future plans constructs the detailed estimate of aviation support requirements. This estimate identifies the number and type of aircraft and the C2 facilities required to support the MAGTF concept of operations. The detailed estimate of aviation support requirements is provided to the MAGTF commander following the MAGTF OPT comparison and decision step. It will include the—

- Number of aviation and C2 assets required by type.
- Quantity of fuel necessary to support the aviation element.
- Quantity of ordnance required by type.
- Quantity of organic and external special equipment required by type (e.g., materials handling equipment, slings, winches).

Aviation Concept of Operations

The aviation concept of operations summarizes the support that assigned aviation and aviation support units will provide to execute the MAGTF concept of operations. An ACE task organization is completed, which includes all aviation support units needed for the units specified in the detailed estimate of aviation support requirements. The aviation concept of operations is incorporated into the air operations annex of the OPORD. The aviation

MCWP 3-25.4

concept of operations is general in nature and provides an overall picture of how Marine aviation operations are to be executed. It should answer the following questions:

- Which units are involved?
- What are they required to do?
- When will they do it?
- Where will they do it?
- Why is it being done?
- How is it going to be done?

Preparing Aviation Documents

The Marine TACC future operations prepares the required aviation documents for the operation during orders development. Preparing aviation documents varies with the nature and complexity of the operation and can include ALLOREQs or AIRSUPREQs.

ATO Cycle

The ATO cycle is an integral part of the MAGTF planning process. It provides a concept of aviation operations for a 24-hour period. By using and completing the cycle, planners can ensure that finite aviation assets are used to achieve their maximum effect with correct prioritization based on the main effort. The precise ATO tasking timeline from commander's guidance to the start of ATO execution is specified by the JFC but normally spans a 36- to 72-hour period. The MAGTF air tasking cycle is divided into four phases: apportionment or allocation, allotment, tasking,

and scheduling. Refer to MCWP 3-2, *Aviation Operations*, for more information concerning the MAGTF air tasking cycle.

For operations that involve joint or combined forces, the six-step joint air tasking cycle is used to plan joint air missions. It begins with the JFC air apportionment process and culminates with the combat assessment of previous missions. In joint operations, the MAGTF will conform to the joint air tasking cycle. The MAGTF and joint air tasking cycles are depicted in figures 4-6 and 4-7, on page 4-14.

There are at least four ATOs at any time: the ATO(s) undergoing assessment (the previous day), the ATO in execution (the current day), the ATO in production (the next day), and the ATO in planning (2 days in advance).

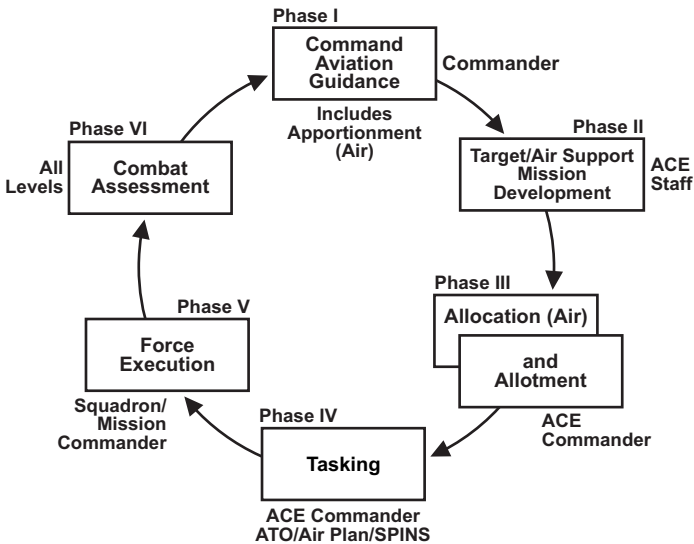

Figure 4-6. MAGTF Air Tasking Order Cycle.

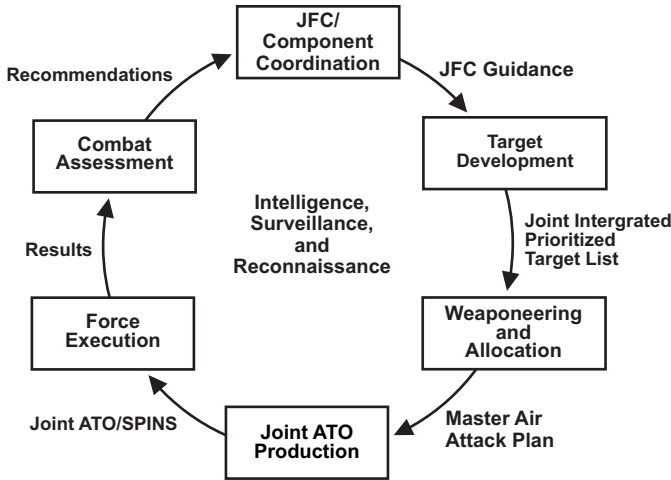

Figure 4-7. Joint Air Tasking Order Cycle.

Target Planning Cycle

Once the MAGTF promulgates the commander’s guidance and intent, the MSCs submit their prioritized requirements for aviation support. The MAGTF validates and prioritizes all aviation requests and forwards this tasking to the ACE for analysis. The product of this assessment is an apportionment recommendation, which is the determination and assignment of the total expected effort by percentage and/or priority that will be diverted to the various air operations and/or geographic areas for a given period of time.

While awaiting the approved apportionment, the ATO planning cell in future operations determines the number of sorties available based on asset location, availability, crew cycles, aircraft capabilities, etc. These assets, in the form of sorties, are scheduled out by unit to meet the requirements of the ATO. If other factors on the day of execution supersede the planned flow (e.g., weather, limited number of targets), the planned sorties would stand alert for the duration of their planned mission time.

Once the apportionment is approved, the ATO development officer in future operations prepares an air ALLOREQ that lists, by mission type, the projected use of ACE sorties. Depending on the theater JFACC, requests for joint sorties may be requested either concurrently as a subparagraph on the ALLOREQ or submitted separately in AIRSUPREQ format. The JFACC will subsequently release a SORTIEALOT message that approves or alters the ALLOREQ to meet the joint force commander's intent. The ALLOREQ and AIRSUPREQ are MAGTF products typically prepared and submitted on behalf of the MAGTF commander by the Marine TACC future operations.

Combat assessment is conducted in the ATO planning cell of future operations as a precursor to the weaponeering board. The weaponeering board should consist of the—

- Deputy G-3.
- The ALD representative.
- Future operations ground watch officer.
- Orders development representative.

MCWP 3-25.4

- Support planners.
- Future plans representative.
- Airspace and air defense planners.
- Strike planners.
- Future operations intelligence watch officer.
- Future operations officer.

Combat assessment is a combination of BDA, as analyzed by the G-2/BDA cell and presented to the intelligence watch officer, and munitions effectiveness assessment, as analyzed by the weaponeering board based on input from the flying units. The output of this collaborative assessment is a potential reattack recommendation or internal (ACE) alteration of tactics, aircraft configuration, etc., to elevate weapons systems' lethality and asset survivability. The nominations for reattack are forwarded to the MAGTF for approval and incorporation into the MAAP. The MAGTF develops the MAAP, which will outline in tabular form, the targets, precedence, effect, and system (weapon) to attack the target.

The ATO planning cell in future operations extracts the aviation-specific targets from the MAGTF MAAP and, coupled with the approved and prioritized target reattack nominations, conducts weaponeering and force application analysis to give detail to the flow plan. Once the ACE assets are expended against the aviation directed targets, a certain number of targets may be left unsourced.

Unsourced targets may, if approved by the MAGTF commander, be forwarded up to the joint force level for common sourcing. If those targets remain unsourced at the joint level, the MAGTF will determine if the targets warrant a change on the day of execution (e.g., reflowed and included as secondary targets against sourced targets or pulled and included as updated targets as part of the

ATO update process supported by the ACI target validation section) or are renominated and included on subsequent ATOs.

The outputs of the ATO planning process are the paper products (e.g., target planning worksheets, SPINS inputs, unit remarks, execution checklists, frequency changes, check-in procedures) that are passed through the ATO development officer to the ATO production cell in future operations, where the plan is entered into the electronic planning medium (i.e., TBMCS). A rough draft is passed back through to the ATO development officer for conversion and ultimate transmission to the theater level to merge into the joint ATO.

Intelligence Planning Cycle

Preliminary Intelligence Estimate

The preliminary intelligence estimate furnishes the commander with the intelligence data necessary to formulate basic decisions and assists in developing planning guidance. Aviation IPB is useful throughout the planning process. IPB can graphically depict—

- Radar horizons and optimal mission engagement ranges for ground-based air defenses.
- Aircraft combat radii at different configurations.
- Tactical air-to-surface missile ranges, optimal launch points, time and distance factors.
- Vital areas and their associated missile engagement zones and fighter engagement zones.

MCWP 3-25.4

- Terrain masking for routing helicopterborne forces.
- Gaps in integrated air defense system radar.
- Weather graphics to depict optimal altitudes for flight operations.

IPB can graphically display friendly C2 measures, location of high value airborne assets, weather, etc., relative to the threat.

Intelligence Estimate

Intelligence gathering against enemy forces is a continuous process that begins immediately after receipt of the initiating directive and continues throughout the operation. The intelligence estimate addresses characteristics of terrain in the area of operations; general strength, disposition, and composition of enemy forces; anticipated weather and conditions for the operational timeframe; locations of civilian population concentrations; and places having specific law of war restrictions. This estimate should also address—

- Intelligence requirements.
- Preparation of collection plans.
- Processing and dissemination techniques.
- Collection of information.
- Dissemination of updated information.

To maximize effectiveness, intelligence estimates and threat analyses must be prepared with respect to friendly force capabilities and intentions and should emphasize how the threat will impact the ACE mission.

Other Planning Considerations

The following planning considerations are embedded in the aviation PDE&A cycle.

Aviation Command, Control, and Communications Planning

The ACE is supported by the MACCS for the command and control of ACE assets. The ACE G-3 and G-6 sections, in conjunction with the MACG S-3/S-6 and subordinate S-3/S-6 sections, prepare a communications estimate of supportability based on the proposed COAs. The G-6 section coordinates communication requirements with the MAGTF G-6 including frequency requirements, data links, and communications security. Appendix D provides the current voice and data communications nets used by the Marine TACC. The ACE G-3 and the Marine TACC battlestaff develop the ACP, which includes ACMs (e.g., control points, handover points, return to force procedures), air defense control measures (e.g., CAP positions, destruction areas), asset allocation, and establishment of priorities of effort to support the concept of operations.

Assault Support Planning

Antiair Warfare Planning

Preliminary assault support estimates are based on the MAGTF commander's guidance and intended concept of operations. Missions and tasks assigned to assault support aircraft include combat

MCWP 3-25.4

assault transport, air delivery, aerial refueling, air evacuation, TRAP air logistical support, and battlefield illumination.

Some degree of local air superiority is usually established in the area of operations to permit the conduct of operations at a given time and place without prohibitive interference by the enemy force. The ACE tasks organic assets and coordinates outside requirements to provide antiair coverage for the MAGTF. Successful accomplishment of antiair warfare requires that the complete capabilities of the MAGTF be merged into an integrated air defense system. This system must be capable of operating independently or as an integral part of the overall amphibious or JTF antiair warfare system. Antiair warfare includes air surveillance, control, and weapons employment. It also includes OAAW. An extensive IPB is required to assist the commander to plan for viable OAAW targets. Refer to MCWP 3-22, *Antiair Warfare*, for a detailed discussion of antiair warfare.

Offensive Air Support Planning

The MAGTF's inherent combat power is enhanced through the application of combined arms. The MAGTF integrates aviation assets with organic fire support assets to effectively support the scheme of maneuver. The MAGTF commander uses offensive air support throughout the operational spectrum to assist in attaining objectives. The firepower, mobility, and flexibility provided by offensive air support are critical to establish favorable conditions for close, deep, and rear operations.

Air Reconnaissance Planning

Timely reconnaissance is required for intelligence updates, initial mission planning, and follow-on damage assessments. In addition

to manned aircraft, the MAGTF controls UAV assets that must be integrated and deconflicted within the ACP. Air reconnaissance does not conduct targeting but provides target acquisition and collects information used in the targeting process.

Information Operations Planning

Information operations are the integrated employment of electronic warfare, computer network operations, psychological operations, military deception, and operations security, in concert with specified supporting and related capabilities, to influence, disrupt, corrupt, or usurp adversarial human and automated decisionmaking while protecting our own. (Joint Publication [JP] 3-13) A key to successful information operations is achieving and maintaining information superiority, particularly in austere and distributed locations.

Information operations, as a responsibility of the ACE, falls under the purview of the ACE G-3 and covers all endeavors of the ACE. The ACE G-3 must formulate and execute a plan that uses the assets available from other areas of the ACE staff. This plan must use all of the appropriate intelligence assets available to the ACE G-2 in the ACI, the technical expertise resident within the ACE G-6 and the Marine wing communications squadron, and the technical expertise available within the MTACS. This plan should be flexible, understandable, useable, and cover defensive and offensive aspects of information operations.

Electronic Warfare Planning

Electronic warfare contributes to the success of information operations by using offensive and defensive tactics and techniques in a variety of combinations to shape, disrupt, and exploit the enemy's use of the electromagnetic spectrum, while protecting

MCWP 3-25.4

friendly freedom of action in that spectrum. Electronic warfare planning should be fully integrated with the MAGTF's overall plan. Refer to JP 3-13, *Information Operations*, and 3-13.1, *Electronic Warfare*, for a detailed discussion of information operations and electronic warfare.

Chapter 5

Operations

Air command and control enables the ACE commander and battlestaff to provide responsive, timely, and effective aviation support to assist the MAGTF commander in prosecuting maneuver warfare on land or sea. The Marine TACC facilitates the use of ACE capabilities as a maneuver force. Although there are operational and organizational differences when the Marine TACC is employed in amphibious and joint or multinational operations, the basic principles of Marine TACC operations and employment are the same.

Employment

The Marine TACC can task-organize a system to meet the capabilities requirements necessary to support its designated mission. The single most important consideration when determining mission supportability is that there is only one Marine TACC within a MAGTF's area of operations. The Marine TACC's capabilities cannot be divided to support one mission without significantly degrading the capabilities of the remaining echelon. Examples of Marine TACC employment packages are the Marine TACC site, the tactical air direction center (TADC) site, the echelon site, and the austere Marine TACC site.

Marine TACC Site

Functioning as the senior MAGTF air C2 agency, this configuration provides the ACE commander with the capability to perform

the complete array of Marine TACC tasks (see chapter 2). The traditional Marine TACC is employed during scenarios involving high-tempo air operations. It includes a fully automated Marine TACC capability that uses the preponderance of the MTACS's equipment and personnel and will most likely require additional personnel and equipment augmentation. See figure 5-1.

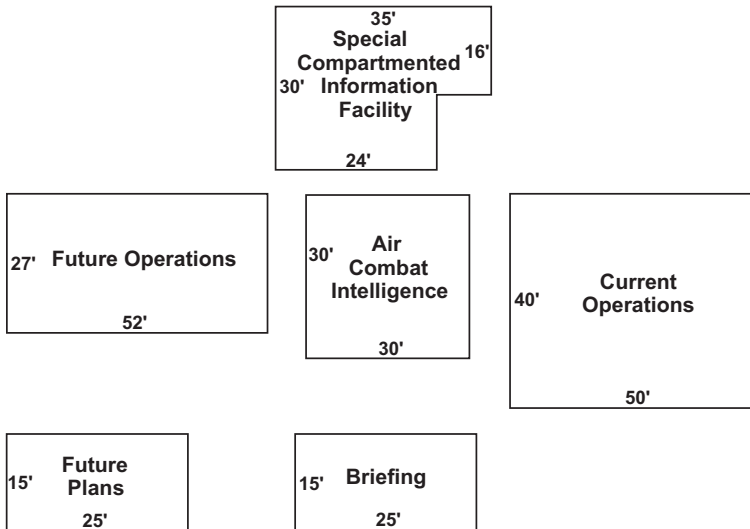

Figure 5-1. Preferred Marine TACC Layout.

Tactical Air Direction Center Site

The TADC site is task-organized to perform all or most of the Marine TACC's tasks but is employed in a subordinate role to a senior air C2 agency. An example would be during expeditionary operations when the TADC is subordinate to the Navy TACC. In

this circumstance, the TADC and the Navy TACC will normally exchange roles during the phasing of control ashore. However, a TADC site subordinate to a Marine TACC may also be established within a MAGTF's area of operations to provide the ACE commander with additional coordination support. In this case, a TADC site may be established at a FOB or remote airfield to coordinate MAGTF aviation activities within a specific area. In these examples, the TADC may be assigned to perform specific functions as directed by its senior agency or the ACE commander or it may mirror the senior agency's functions in the capacity as an alternate Marine TACC or in preparation for assuming sector airspace management functions. Depending on the TADC's role, it may be task-organized to perform senior supervisory planning and coordination functions provided by a Marine TACC. The TADC site's equipment capabilities will depend strictly on its assigned role and functions.

Echelon Site

An echelon site is an operational site capable of performing the majority of Marine TACC tasks but will usually be operated for a limited period to allow the Marine TACC to relocate. During operations, the echelon site incrementally assumes Marine TACC functions and continues to perform functions until the Marine TACC site is prepared to resume its functions. Assets for the echelon site may come from the echeloning Marine TACC or from another Marine aircraft wing's MTACS. The overall emphasis for the echelon site is to allow the Marine TACC's relocation with little or no affect on operations.

Austere Marine TACC Site

The austere Marine TACC site is capable of performing a limited number of Marine TACC tasks. It is task-organized to perform

MCWP 3-25.4

specific, identified functions in situations involving low-intensity air operations. These functions will normally be limited to providing data link connectivity with other air C2 agencies and limited supervision of subordinate MACCS agencies. The austere Marine TACC site may also provide limited ACE planning functions and liaisons to organizations external to the MAGTF.

MAGTF Operations

The ACE is task-organized to conduct air operations. It includes the MACCS agencies necessary to perform aviation C2 functions commensurate with the size and mission of the MAGTF.

The Marine TACC, when employed, is incrementally phased ashore as a TADC responsible to the commander, amphibious task force (CATF) for the landward sector of the amphibious objective area. With the MAGTF fully established ashore and as a prerequisite to terminating an amphibious operation, the CATF will delegate authority for command and control of air operations in the amphibious objective area to the commander, landing force (CLF). The landward TADC will become a Marine TACC, while the CATF's Navy TACC becomes a TADC. After terminating the amphibious operation, the amphibious objective area will be dissolved and an airspace sector will be established. The Marine TACC then provides command and control of aviation assets in its sector.

Marine Expeditionary Force

A MEF is supported by a fully capable Marine TACC. The ACE commander plans and directs MAGTF air operations and related aviation activities from this facility. The Marine TACC maintains

communications with higher, adjacent, and external headquarters, subordinate aircraft groups, and other MACCS agencies. The Marine TACC exchanges tactical digital information in the joint and multinational arena through data link interface.

Marine Expeditionary Unit

The ACE typically associated with a MEU cannot perform all six functions of Marine aviation. It contains the necessary assets and agencies to conduct operations ashore for a limited time. The MEU can be supported from its sea base or from shore-based facilities in a joint environment. Centralized command and control of air operations are retained by the Navy TACC.

Marine Expeditionary Brigade

The ACE for a MEB is typically comprised of a reinforced MAG, but it can be task-organized to best fulfill mission requirements. The Marine TACC that supports a MEB will draw upon the appropriate components of the MEF TACC in order to allow the ACE commander to plan and direct MAGTF air operations. The MEB TACC will maintain communications with higher, adjacent, and external headquarters; subordinate squadrons; and other MACCS agencies.

Amphibious Operations

During an amphibious operation, MACCS air control facilities (whose functions parallel those of the Navy's TACC) are established ashore. Once operational ashore, the Marine TACC is subordinate to the Navy TACC (afloat) and monitors appropriate circuits and gains situational awareness in preparation for assuming command and control within an assigned sector.

Tactical Air Direction Center

During the build-up of landing force combat power ashore, the CLF establishes a TADC to act as a coordinating agency between the other MACCS agencies ashore and the Navy TACC afloat. The TADC is identical in organization, capabilities, and facilities to a TACC. The essential difference between a TACC and a TADC is a matter of command authority over the assigned sector. MACCS agencies remain responsible to the Navy TACC (afloat) even when a TADC is established, unless directed otherwise.

Tactical Air Command Center (Ashore)

When the CLF is capable of assuming control of all air operations in the amphibious objective area, the CATF will delegate sector airspace management responsibilities to the CLF. The CLF's TADC then becomes the Marine TACC while the Navy TACC (afloat) reverts to a subordinate status of TADC (afloat) yet remains capable of assuming the TACC role.

Phasing Control Ashore

Phasing control ashore is the process whereby the authority to control and coordinate certain functions is passed from the CATF to the CLF. Checklists, used to ensure that various operational functions are resident at the TADC, may be used as a tool to measure the readiness of the TADC to assume sector airspace control functions. The OPORDs and local standing operating procedures

should be reviewed for such documentation. In addition to checklists, other prerequisites must be met before TACC functions can be passed to the Marines. In general, the prerequisites are—

- Certain air control facilities or agencies must exist ashore.
- Facilities or agencies must be able to communicate on certain required nets.
- Facilities or agencies must be able to perform C2 and communications functions.

When conducting amphibious operations, the transition from a sea-based to a land-based air C2 system follows a five-phase process. Depending on the scale of operations, some or all of the phases may be completed. The sequence of phasing control ashore is as follows:

- First phase is the arrival of various supporting arms controllers ashore, namely the tactical air control party.
- Second phase is the arrival ashore of two specific agencies: the DASC and FSCC.
- Third phase is the arrival of the TAOC.
- Fourth phase is the establishment of the TADC.
- Fifth phase is the transfer of command responsibility from afloat to ashore and is distinguished by the reversal of TACC and TADC roles between the CATF and CLF. During this phase, the Marine TACC is established ashore and the Navy TACC reverts to a TADC role. The landing force ACE normally moves ashore during this phase.

Joint or Multinational Operations

As the senior MACCS agency, the Marine TACC provides the MAGTF's interface with other Service or host nation's air C2 agencies in joint or multinational operations. The MAGTF commander retains operational control of organic aviation assets. During joint operations, the MAGTF commander may make sorties available to the JFC for tasking through the JFACC for air defense, long-range interdiction, and long-range reconnaissance. Also, sorties in excess of MAGTF direct support requirements are provided to the JFC for tasking to support other joint force components or the joint force as a whole.

Joint or Multinational Planning

In almost any foreseeable operation, the ACE must integrate aviation assets into joint and coalition operations. The ACE commander and MACCS planners must represent the MAGTF's needs and account for JTF and theater requirements as well as the capabilities and limitations of joint and coalition aircraft, air command and control, and air defense assets. At a minimum, the Marine TACC planners must be cognizant of the unique requirements of MAGTF for airspace, air defense, and C2 challenges with different joint tactics, techniques, and procedures; language barriers; and classification considerations.

Liaisons

The MAGTF must ensure proper coordination and integration of Marine Corps forces (MARFOR) with joint forces. Representation on joint staffs and agencies, including liaison personnel, is essential to ensure proper employment of forces.

The ACE commander, in exercising authority to command, control, and coordinate MAGTF air operations through the Marine TACC, will ensure joint staff or agency and liaison representation to the JFACC or joint force commander's staff, JAOC, ACA, and AADC. The ACE sources personnel for liaison billets from within the Marine aircraft wing or from the Marine Corps combined force air component commander or JFACC liaison and augmentation team. One of the Marine TACC's contacts within the JAOC is the Marine LNO. The Marine LNO is the MAGTF commander's representative to the JFACC, AADC, and/or ACA for the exchange of current intelligence and operational data with the Marine Corps component. The Marine LNO is responsible to the JFACC for matters pertaining to MAGTF operations to ensure coordination for mutual understanding and unity of purpose and action. See appendix B for information on augmentees and liaison personnel. The Marine LNO's responsibilities are—

- Maintaining awareness of the status of all Marine cross-force tasked air missions and keeping JAOC members advised of significant changes to those missions.
- Coordinating MAGTF interest for air defense, long-range interdiction, and long-range reconnaissance missions.
- Coordinating and resolving MAGTF issues regarding air operations, airspace, and air defense matters with JAOC personnel.

Interoperability

Effective air operations by joint force components hinge on the ability of air C2 agencies to effectively integrate and exchange air combat situation displays and information on a real-time basis. Extensive use of TADILs facilitate the rapid, secure, and simultaneous exchange of combat information relative to air operations.

Planning for interoperability includes detailed planning and coordination of equipment, personnel, and terminology.

Combat Operations

During the execution of the current ATO, a myriad of permutations will occur that will require an OODA loop process (see fig. 5-2). If current operations can be viewed as a timepiece, where the macro view of executing ACE current operations in its totality is a master OODA loop, then individual cells and problems require an OODA loop process as smaller gears synchronously moving to produce a timely output.

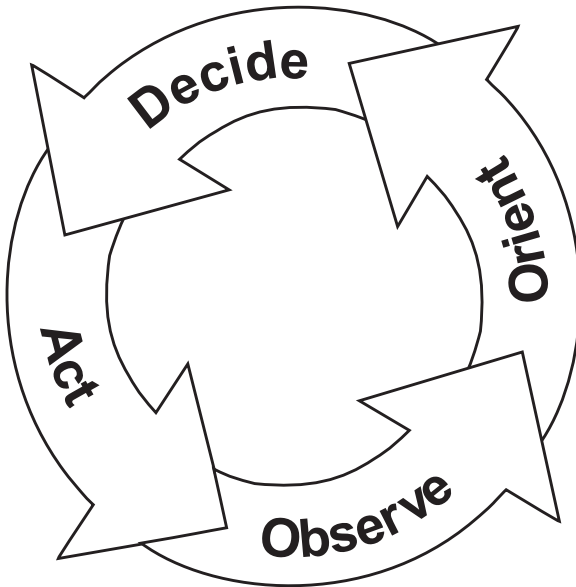

Figure 5-2. The OODA Loop.

Two key processes of current operations are providing simultaneous and synchronous aviation support to the close and deep battles.

The DASC maintains a constant dialog with the close battle cell (as well as the deep battle and assessment cells, if required) in the Marine TACC to ensure preplanned and immediate sorties apportioned to the GCE are handled on a priority basis as determined by the GCE commander. The allocated sorties are typically launched either based on a preplanned flow (ATO estimated time of departure) or as requested by the supported unit (e.g., on-call, strip alert, divert).

The deep and close battle cells monitor and adjust the flow and assignment of allocated sorties as the tactical situation dictates. The assessment cell, based on emerging threats and priority targets of opportunity, provides recommendations and cost and benefit analysis to the SWO regarding the retasking of assigned assets to alternate missions. The assessment cell analysis differs from that done by the close and deep battle cells in that it is further out in scope and time (typically more than 2 hours). The assessment cell monitors the flow of GCE apportioned sorties and analyzes any requirements that exceed the allocation. This analysis occurs in consonance with the intelligence watch section (threat and enemy situation), ground watch section (MAGTF priority change), deep battle cell (impact on deep battle as assets are shifted to the GCE), and the SWO if a surge effort was anticipated and approved.

Succession of Command and Control

One of the Marine TACC's principal tasks is to prescribe succession of C2 responsibilities within the MACCS to compensate for

any serious degradation within the C2 system. Normally the TAOC is designated as the primary succession agency for the Marine TACC. The specific procedures for succession of C2 vary with the available communications and the tactical situation.

Marine TACC Siting Considerations

Selection of a tactical site is the result of balancing the demands of a variety of factors. The final site selection should satisfy the basic requirements of a Marine TACC.

Mission Requirements

Mission requirements will drive the location of the Marine TACC. The MAGTF commander's requirements may place additional limitations on possible Marine TACC site locations.

Suitable Terrain

The Marine TACC requires an area approximately 150 meters by 150 meters for adequate site setup. The area should be relatively flat with a surface slope not exceeding 10 degrees.

Terrain Masking

Terrain surrounding the potential Marine TACC site should provide natural concealment for the Marine TACC's equipment and shelters. When feasible, masking terrain should be interposed between the Marine TACC and vulnerable emitter sources (antennae farms and generators) and between the Marine TACC and the primary enemy avenues of approach.

Proximity to Key Assets and/or Nodes

The primary role of Marine aviation is to support the MAGTF. The key to providing the MAGTF with effective aviation support is the ability to communicate and coordinate with the other elements of the MAGTF (i.e., CE, GCE, and LCE). When selecting a site for the Marine TACC, the ACE commander should place the Marine TACC where it can best conduct communications and coordination. Proximity to other key commanders and/or C2 nodes allows for more rapid response to the MAGTF elements and decreases the potential for misunderstandings. There is no requirement for the Marine TACC to be collocated with other aviation assets in an airfield. Insistence on locating the Marine TACC at an airfield (e.g., distant from the rest of the MAGTF) may handicap the ACE's ability to effectively support the MAGTF. If and when such connectivity problems occur, it is the obligation of the ACE to provide communications back to the airfields and to ensure the aviation effort properly supports the MAGTF. The ACE should not place the burden of establishing connectivity on the other elements of the MAGTF. To provide this connectivity to the airfields as well as to the components of the MACCS, the Marine wing communications squadron will collocate with the Marine TACC to provide most of the Marine TACC's voice and data communications connectivity. Site considerations should allow sufficient space and logistical support for the employment of the Marine TACC and Marine wing communications squadron's equipment (e.g., antenna farms, satellite dishes, and multichannel equipment).

Communications Engineering

Communications requirements and communications system vulnerabilities are critical in site selection. Key considerations are

line-of-sight access to other agencies, adequate space for erecting and remoting antennas, and positioning units to take advantage of terrain masking and to support the use of bidirectional antennas. Proper communications engineering will limit the radio frequency signal susceptibility to collection by enemy electronic devices. Operating limitations of available communications equipment may limit distances between key C2 system nodes. The presence of terrain, which may be used to mask signals or to support signal defraction, could be considered. Availability of host nation public telephone and telegraph facilities is a critical element of site selection. To a limited degree, geomorphic characteristics of the surrounding environment may also be a consideration. Electromagnetic emission sources surrounding the potential site may inhibit the proper use of communications assets in some areas.

Physical Security

The selected site should provide adequate space to allow for installation of a barbed wire barrier at least 30 meters from any major structure. The site should be sufficiently isolated to preclude easy access by local inhabitants. When practical, the Marine TACC should be collocated with other ACE or MAGTF assets to enhance security team augmentation.

Accessibility

The Marine TACC should be located in an area that provides a sufficient transportation infrastructure to allow rapid and easy movement of personnel between the Marine TACC and supporting or external agencies.

Dispersion

The Marine TACC should be adequately dispersed from other key C2 nodes to prevent easy identification or prioritization as an enemy target. Marine TACC equipment and shelters will be emplaced using maximum, practical separation.

The Marine TACC location must be logistically supportable. Access to heavy equipment support, refueling of electrical generation equipment, and availability of motor transport augmentation are considerations.

Cover and Concealment

Because of its large footprint, the Marine TACC is difficult to conceal from a determined enemy. Proper use of cover and concealment can reduce the Marine TACC's vulnerability to enemy detection. The existence of foliage to screen key structures, the presence of overhead cover, and natural depressions where key Marine TACC elements can be hidden are characteristics of a suitable site. The availability of space for deception sites and avoidance of areas where excessive dust is generated may also be considered when selecting a site.

Occupation Process

Once a site is selected, the occupation process begins. First, a surveillance liaison reconnaissance party consisting of Marines

from MTACS, Marine aircraft wing headquarters, Marine wing headquarters squadron, and Marine wing communications squadron will conduct a survey of the intended site. After equipment locations are finalized, each location will be marked by paint, stakes, etc., and a map of the area will be prepared. The advance party representatives will serve as guides for emplacement of their respective section's equipment to ensure proper installation in accordance with the Marine TACC layout plan. Marine TACC equipment will be time-phased to ensure that critical assets arrive first.

The initial equipment required to begin site setup includes generators, materials handling equipment, and communications equipment. They are followed by the shelter suite, associated computers, and other communications-electronics vans and cabling. Remaining items are phased into the site last.

Site Security Considerations

Barriers

At a minimum, triple-strand concertina wire should be erected surrounding the Marine TACC compound. If possible, the wire should be erected so that major facilities are further away from the perimeter than the normal distance a grenade can be thrown (i.e., 30 meters or 100 feet).

Guard Coordination

Coordination for the site security should be conducted with the Marine wing headquarters squadron that is normally tasked to support compound security. The sensitive compartmentalized

information facility will be collocated with the Marine TACC. Security elements for the Marine TACC and the sensitive compartmentalized information facility will be combined. A guard post at the compound entrance and sufficient guard personnel to maintain observation of the entire perimeter at all times are required for adequate security.

Security Procedures

Measures taken to enhance compound security include strict adherence to noise and light discipline; current, up-to-date access rosters (which include names, ranks, and social security numbers of site personnel) with the compound guard and in Marine TACC work sections; and the establishment of a vehicle drop-off point at least 500 meters from the compound. Security actions should be coordinated to ensure that adequate communications, reaction plans, and identification procedures exist.

Site Hardening Considerations

A prehardened facility is the preferred method of employing the Marine TACC. If prehardened facilities are not available, the Marine TACC equipment and shelters should be hardened unless deemed unfeasible.

Revetment or Hardening of Generators

Generators will be revetted or hardened at the earliest opportunity. Revetting or hardening reduces the electronic signature and increases the generator's survivability against destruction. Generator exhaust can be vented via ducting to a baffle (some are constructed using a buried 55-gallon drum) to reduce the infrared

radiation signature. The most efficient and effective means of building revetments is with a bulldozer.

Hardening of Operating Shelters

Sandbags can be used to harden the operating shelters. Sandbags may be preferred because a bulldozer could cause significant disruptions to the surrounding area and leave a telltale site signature. Air raid shelters and trenches should be dug near the Marine TACC to provide for personnel safety in case of air attack.

Number of Bunkers

Several bunkers are required to support the Marine TACC. Guard bunkers are required at the entrances to the compound. Air raid shelters are required near the work spaces and billeting areas. Additionally, fighting positions and bunkers for crew-served weapons may be required if MTACS personnel are included in a sector of the base defense or rear area security plan.

Appendix A

Manning Requirements for Baseline Marine TACC

This appendix presents manning requirements for a baseline Marine TACC. Tables A-1 through A-4 describe manning requirements for ACI, current operations, future operations, and future plans. Manning requirements for the CAOC and JAOC are presented in table A-5. Most of the positions within future plans, future operations, and current operations can be sourced from the Marine aircraft wing. Most of the positions in ACI will require sourcing from outside the Marine aircraft wing. Position descriptions followed by an asterisk indicate watch positions filled by personnel that will most likely require sourcing outside the MTACS but within the MACCS.

Table A-1. ACI Manning.

Position Description	Rank	MOS	No.
Air Combat Intelligence			
ACI officer	LtCol	0202	1
Assistant ACI officer	Maj	0202 or 0207	1
ACI chief	MSgt	0231	1
Assistant ACI chief	GySgt	0231	1
ACI operations assistant	Sgt	0231	1
ACI operations assistant	Cpl	0231	1
Intelligence Analysis Section Center			
Intelligence analysis officer	Capt	0202	1
Assistant intelligence analysis officer	Capt	0202	1
All Source Intelligence Cell Center			
Senior analyst	Lt	0202 or 0207	2
Chief analyst	GySgt	0231	2
Intelligence analyst	SSgt	0231	2
Intelligence analyst	SSgt	0231	2
Order of Battle Cell Center			
Order of battle analyst	Sgt	0231	2
Order of battle analyst	Cpl	0231	2
Imagery Analysis Cell			
Imagery interpreter	GySgt	0241	1
Imagery interpreter	SSgt	0241	2
SIGINT Section			
SIGINT officer	Lt	0206	1
SIGINT chief	SSgt	2621	1
SIGINT support clerk	SSgt	2621	2
SIGINT analyst	Cpl	0231	1

Table A-1. ACI Manning (Continued).

Position Description	Rank	MOS	No.
Collection Section			
Collection officer	Capt	0202 or 0207	1
Assistant collection officer	Lt	0202 or 0207	1
Collection chief	GySgt	0231	2
Collection clerk	Sgt	0231	2
Targeting Intelligence Section			
Target intelligence officer	Capt	0202	1
Assistant target intelligence officer	Lt	0202	1
Target intelligence chief	GySgt	0231	1
Target Development Cell			
Target development officer	Lt	0202 or 0207	2
Target analyst	SSgt	0231	2
Target analyst	Sgt	0231	2
Target Validation Cell			
Target validation officer	Lt	0202 or 0207	2
Target analyst	SSgt	0231	2
Target analyst	Sgt	0231	2
Battle Damage Assessment Cell			
BDA officer	Lt	0202 or 0207	2
BDA analyst	Sgt	0231	2
BDA analyst	Cpl	0231	2
Intelligence Plans Section			
Intelligence plans officer	Maj	0202	1
Intelligence plans chief	GySgt	0231	1
Intelligence plans analyst	Sgt	0231	1

Table A-1. ACI Manning (Continued).

Position Description	Rank	MOS	No.
Requirements and Dissemination Section			
Research and development officer	Capt	0202 or 0207	1
Assistant research and development officer	Lt	0202 or 0207	1
Research and development clerk	SSgt	0231	2
Research and development clerk	Cpl	0231	2
Intelligence Systems Section			
Systems officer	Lt	0207	1
Systems chief	SSgt	0231	1
Weather Section			
Weather officer	CWO	6802	1
Weather forecaster	SSgt	6842	1
Weather forecaster	Sgt	6842	1
Weather observer	Sgt	6821	1
Weather observer	Cpl	6821	1
Radio Battalion Detachment			
Detachment commander	Capt	0206	1
ELINT chief	SSgt	2631	1
ELINT analyst	Sgt	2631	2
SIGINT analyst	Sgt	2629	2
Sensitive compartmented information communications operator	Cpl	2651	1
TERPES Detachment			
Officer in charge	CWO	2602	1
Detachment staff noncommissioned officer in charge	GySgt	2631	1
Maintenance technician	SSgt	2821	4
ELINT analyst	Sgt	2631	5
ACI Total = 24 officers/65 enlisted			

Table A-2. Current Operations Manning.

Position Description	Rank	MOS	No.
Current Operations			
Current operations officer	LtCol	9969	1
Assistant current operations officer	LtCol	9969	1
Operations chief	GySgt	7041	1
Operations clerk	Sgt	7041	2
Systems Control Section			
C2 watch officer	CWO	0650	2
Radio Central			
Watch noncommissioned officer	Sgt	0621	2
Data/comm technician	Cpl	0651	2
Wireman	Cpl	0612	2
Radio operator	LCpl	0621	8
Ground Watch Section			
Ground watch officer	Maj	0302	2
Fire support officer	Capt	0802	2
Engineer officer	Capt	1302	2
Ground watch chief	SSgt	03XX	2
AFATDS operator	LCpl	7041	2
ACE Watch Section			
Force protection officer	Capt	75XX	2
CBRN watch officer	CWO	5702	2
ALD/ordnance watch officer	Lt	6004	2
Logistic watch officer	Lt	04XX	2
Communications watch officer	Capt or Lt	0602	2
C2 maintenance coordinator	GySgt	0629 or 0659	2
Intelligence Watch Section			
Intelligence watch officer	Maj	0202	2
Intelligence watch chief	GySgt	0231	2

Table A-2. Current Operations Manning (Continued).

Position Description	Rank	MOS	No.
Intelligence analyst	Sgt	0231	2
ELINT analyst	Sgt	2631	2
Current Operations Watch Section			
SWO	LtCol	75XX or 7202	2
SAC	Maj	7202	2
Crew chief	SSgt	72XX	2
Recorder	Sgt	72XX	2
Deep Battle Cell			
Deep battle tasker	Capt	7523 or 7525	2
Deep battle tasker	Capt	7509	2
Deep battle coordinator	Capt	7509	2
UAS tasker	Lt	9910	2
Deep battle recorder	Sgt	72XX	2
Deep battle plotter	Cpl	72XX	2
Close Battle Cell			
Close battle tasker (fixed wing)	Capt	7509 or 7525	2
Close battle tasker (fixed wing)	Capt	7562	1
Close battle tasker (rotary wing)	Capt	7565	1
Close battle air support coordinator (2)*	Capt	7208	2
UAS tasker	Lt	9910	2
Close battle recorder (fixed wing)	Sgt	72XX	2
Close battle plotter (fixed wing)	Cpl	72XX	2
Close battle recorder (rotary wing)	Sgt	72XX	2
Close battle plotter (rotary wing)	Cpl	72XX	2
Air Defense Coordination Cell			
Air defense coordinator	Capt	7210 or 7204	2

Table A-2. Current Operations Manning (Continued).

Position Description	Rank	MOS	No.
Air defense recorder	Sgt	72XX	2
Air defense plotter	LCpl	72XX	2
Airspace Control Cell			
Airspace control officer (1)*	Capt	7220	2
Airspace control officer	Capt	7562	1
Airspace control officer	Capt	7565	1
Airspace plotter/recorder	Sgt	72XX	2
Interface Control/Track Data Cell			
Interface control officer	Capt	7210	2
Track data coordinator	Sgt	7234	2
Battle Damage Assessment Cell			
Senior close battle analyst	Maj	7566	2
Rescue Coordination Cell			
RCC officer	Capt	7566	2
RCC officer	Capt	7565	2
RCC recorder (2)*	LCpl	72XX	2
Current Operations Total = 54 officers/55 enlisted			
* Billet that requires sourcing outside the MACG.			

Table A-3. Future Operations Manning.

Position Description	Rank	MOS	No.
Close battle analyst (1)*	Capt	7208	4
Senior deep battle analyst	Maj or Capt	7523 or 7525	2
Recorder/computer-assisted force management system operator	LCpl to Sgt	7041	4
Deep battle analyst	Capt	7523 or 7525	4
Future Operations			
Future operations officer	LtCol	9969	1
Assistant future operations officer	Maj	9969	1
Operations chief	SSgt	7041	1
Operations clerk	Sgt	7041	1
Operations clerk	Cpl	7041	1
Ground Watch Section			
Ground watch officer	Maj	0202 or 0802	2
Ground clerk	LCpl	03XX	2
Intelligence Watch Section			
Intelligence watch officer	Maj	0202	2
Intelligence analyst	Sgt	0231	2
ATO Development Section			
ATO development officer	LtCol	9969	1
ATO Planning Cell			
ATO planning officer	Maj	7523 or 7525	1
Assistant ATO planning officer	Capt	7523 or 7525	1
Strike planner	Capt	7509	1
Strike planner	Capt	7565	1
Strike planner	Capt	7523 or 7525	2
EW planner	Capt	7588 or 7543	1

Table A-3. Future Operations Manning (Continued).

Position Description	Rank	MOS	No.
Support planner/air tasking coordination officer	Capt	7557	1
Support planner	Capt	7562	1
Support planner	Capt	7563	1
Support planner	Capt	7566	1
UAS planner	Capt	9969	1
Airspace/control measures planner	Capt	7210	1
Air defense planner	Maj	7202	2
Air support planner (1)*	Capt	7208	1
ATO Production Cell			
ATO production officer	Maj	9969	1
Assistant ATO production officer	Capt	9969	1
SPINS/ACP/ADP production officer (1)*	Capt	72XX	1
ATO production chief	SSgt	7041	1
ATO production clerk	Cpl	7041	6
Orders Development Section			
Orders development officer	Maj	9969	1
Strike plans officer	Capt	7523	1
Strike plans officer	Capt	7509	1
Strike plans officer	Capt	7565	1
Support plans officer	Capt	7566	1
Support plans officer	Capt	7562	1
Support plans officer	Capt	7563	1
Force protection officer	Capt	75XX	1
C2 plans officer (1)*	Capt	72XX	1
Operations clerk	Sgt	7041	1
Operations clerk	Cpl	7041	1
Future Operations Total = 43 officers/20 enlisted			
* Billet that requires sourcing outside the MACG.			

Table A-4. Future Plans Manning.

Position Description	Rank	MOS	No.
Future Plans			
Future plans officer	LtCol	9969	1
Senior planner	Maj	9967	1
Airspace/air defense planner (2)*	Maj	7202	2
Assault support planner	Maj	9966	2
Strike support planner	Maj	9965	2
Aviation support planner	Capt	7557	1
MAGTF plans chief	GySgt	0511	1
MAGTF plans noncommissioned officer	Sgt	0511	2
MAGTF plans clerk	LCpl	0511	3
Future Plans Total = 9 officers/6 enlisted			
* Billet that requires sourcing outside the MACG.			

Table A-5. CAOC/JAOC Manning.

Position Description	Rank	MOS	No.
CAOC/JAOC MARINE LIAISON STAFF (resident within CAOC)			
Marine liaison	Col	8042	1
Assistant Marine liaison	Col	8042	1
Marine Liaison Plans			
ATO/DS planners (TBMCS trained, minimum of one planner with fixed-wing expertise)	Maj or LtCol	75XX	3
Command, control, and communications/air space planner (TBMCS trained, weapons tactics instructor)	Maj or LtCol	72XX	2
KC-130 planner	Capt or Maj	7555	1
Marine Liaison Operations			
Operations chief	Maj or LtCol	75XX 72XX	2
Fixed-wing weapons tactics instructor	Maj or LtCol	75XX	2
Advanced TBMCS operator	E-6/7	72XX	2
Intelligence, Surveillance, and Reconnaissance Division Liaison			
Intelligence, surveillance, and reconnaissance collection	Capt or Maj	0202	2
BDA cell	E-5/6		2
Marine liaison administrative/logistics	E-6/7		2
Total = 14 officers/6 enlisted			
CAOC/JAOC AUGMENTATION STAFF (resident within CAOC)			
Deputy director CAOC	BGen	8003	1
Strategy Division			
Deputy strategy division	Col	75XX	1
Strategy plans	Maj or LtCol	75XX 72XX	1
Combat Plans			
Deputy combat plans	Col	8042	1
Guidance apportionment and targeting cell	Maj or LtCol	75XX	1

Table A-5. CAOC/JAOC Manning (Continued).

MAAP cell (weapons tactics instructor expertise) (F/A-18, EA-6B, AV-8B, CAS planner, 72XX)	Capt or Maj	75XX 72XX	4
ATO production	E-5/6		1
Combat Operations Division			
Director combat operations division	Col	8042	1
CAS cell	LtCol or Col	75XX	2
Interdiction cell	LtCol or Col	75XX	2
Time sensitive targeting cell	Maj or LtCol	75XX	1
JSRC cell	Maj	75XX	1
Total = 17 officers/1 enlisted			

Appendix B

Augments, Liaisons, and Additional Marine TACC Positions

Effective liaison among forces is essential for coordinating MAGTF air operations and is a key factor in its success. The ACE commander will provide liaison elements to assist and coordinate planning and execution of air operations. ACE liaison personnel represent the ACE commander at senior headquarters. They are responsible to the ACE G-3, and they serve to expedite the exchange of information between the Marine TACC and senior headquarters. They represent the ACE's capabilities and limitations at levels of command where the ACE commander must continually be involved but is seldom able to visit. Depending on the situation, transportation, and electronic connectivity availability, the liaison personnel will be located at senior or adjacent headquarters or will travel between these headquarters and the Marine TACC.

The two non-MAGTF organizations that most directly affect the employment of ACE assets in a joint or multinational force are the JTCB and the JFACC's JAOC.

Manpower requirements for liaison and augmentation billets at the joint targeting coordination board (JTCB) and the JAOC are presented at table B-1 on page B-2.

Joint Targeting Coordination Board

A JFC may establish and task a JTF-level organization within the command to accomplish broad targeting oversight functions. This

MCWP 3-25.4

organization is usually called a JTCB. The JTCB functions as the review and integration center for JTF targeting efforts. It is a joint activity composed of representatives from the JTF staff, their components, and, if required, their subordinate units.

Table B-1. JTCB and JFACC Liaisons and Augments.

Position Description	Rank	MOS	No.
JTCB component representative	BGen	9903	1
JAOC senior Marine LNO	Col	9907	1
Combat operations deputy director	Col	9907	1
Combat operations fighter duty officer	Capt	7523 or 7525	2
Combat operations fighter duty officer	Capt	7509	2
Combat operations EW representative	Capt	7543 or 7588	2
Combat operations tanker representative	Capt	7557	2
Combat operations ADA representative (1)*	Capt	7204	2
Combat operations airspace representative (2)*	Capt	7208	2
JSRC liaison officer	Capt	7566	2
BCD (operations) MEF operations LNO	Maj	0302	2
BCD (operations) MEF intelligence LNO	Capt	0202	2
Combat plans senior Marine planner LNO	LtCol	9969	1
Combat plans ATO development planner (strike)	Capt	7523	1
Combat plans CAS planner	Capt	7509	1
Combat plans EW planner	Capt	7543 or 7588	1
Combat plans tanker planner	Capt	7557	1
Combat plans helo planner	Capt	7562	1
Combat plans helo planner	Capt	7565	1
Combat plans clerk	Cpl	7041	1
Campaign Plans Strategy Branch			
Strategy LNO	LtCol	9969	1
Intelligence LNO	Capt	0202	1
ATO development senior planner	LtCol	9969	1

**Table A-5. JTCB and JFACC Liaisons
and Augments (Continued).**

Position Description	Rank	MOS	No.
ATO development strike planner	Maj	7523 or 7525	2
ATO development intelligence planner	Capt	0202	1
ATO development CAS planner	Capt	7509	1
C2 plans air defense planner (1)*	Capt	7210	1
BCD (plans) MEF operations liaison officer	Maj	0302	1
BCD (plans) MEF intel liaison officer	Capt	0202	1
AWACS Marine Corps liaison officer (ACE)	LtCol	9969	3
AWACS Marine Corps liaison officer (3)*	Capt	7210	3
Liaison Total = 44 officers/1 enlisted			
*Billets that require sourcing outside the MACG. AWACS - Airborne Warning and Control System ADA - air defense area BCD - battlefield coordination detachment			

Joint Force Air Component Commander

The JFC will normally designate a JFACC. His primary purpose is to coordinate the use of air power for the benefit of the joint force in support of the JFC’s objectives. The JFACC is the Service component commander who has the preponderance of air assets to be used and the command, control, and communication ability to assume that responsibility. The JFACC’s responsibilities include planning, coordinating, allocating, and tasking of joint air operations based on the JFC’s concept of operations and air apportionment decision.

The JFACC’s operations center will be designated a JAOC. The JFACC’s JAOC is structured to operate as a fully integrated facility and staffed to fulfill all of the JFACC’s responsibilities.

Joint Air Operations Center

The mission of the JAOC (see fig. B-1) is to synchronize air operations with air, land, or sea operations through centralized planning, direction, and coordination, and the exchange of operational and intelligence data with all components and agencies of the joint force. The JFACC may also be the designated ACA and/or the AADC and will also develop the ACP, ACO, and ADP. JFACC organizations may differ based on the theater of operation. The three divisions that should be common to all JAOCs are combat plans, combat operations, and combat intelligence.

The combat plans division produces the ATO, ACP, ACO, and ADP. It is comprised of the air strategy, ATO production and development, and airspace command and control branches. The air strategy branch develops and plans the strategic direction for joint air operations. The ATO production and development branch produces a timely and executable joint ATO. The airspace command and control branch develops, coordinates, and publishes plans, concepts of operations, and detailed procedures for the combined interoperability and integration of C2 systems.

The combat operations division manages the execution of the ATO, corrects any problems that may occur, and reacts to changes in guidance or the status of friendly and enemy forces. Combat operations consist of a cadre of fighter, reconnaissance, surveillance, combat support, tanker, bomber, and airlift personnel experienced in battle management. It is normally comprised of the weather support, operations support, and JSRC branches. The weather support branch provides forecasts tailored for the various requirements, reports significant weather, and inputs weather data in TBMCS, if required. The operations support branch tracks the flow of assets and status of missions dedicated to each operation

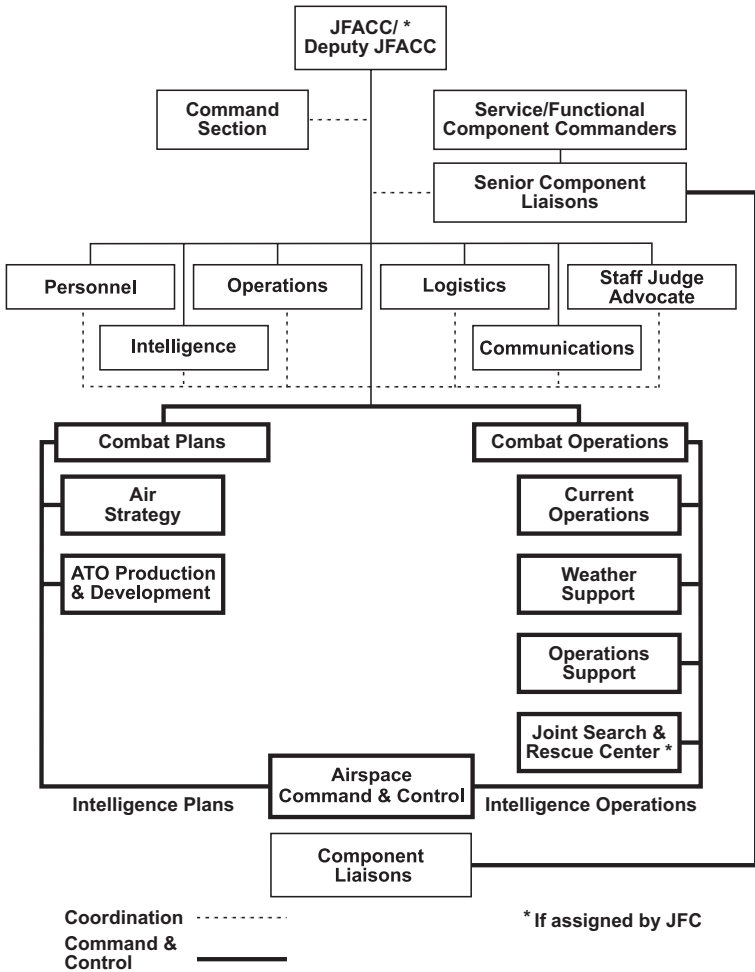

Figure B-1. Joint Air Operations Center.

(may include airlift, air refueling, reconnaissance, and medical evacuation missions). The JSRC branch disseminates the JFC's

MCWP 3-25.4

CSAR concept of operations to all components and establishes C2, communications, and reporting procedures for component search and rescue center operating centers, coordinates component joint CSAR plans to resolve actual or projected shortfalls in assets and capabilities, and monitors all joint CSAR incidents and missions.

The combat intelligence division provides for all intelligence activities in the JAOC. It is comprised of the intelligence plan and intelligence operations branches. The intelligence plan branch supports the planning and development of the joint ATO. The intelligence operations branch supports the execution of the joint ATO.

JFACC Liaison Elements

Battlefield Coordination Detachment

The battlefield coordination detachment (BCD) is provided by the Army component commander to act as the interface between the ground component commander and the JFACC for processing land force requests for air support, monitoring and interpreting the land battle situation for the JAOC, and providing the necessary interface for the exchange of current operational and intelligence data.

Special Operations Liaison Element

The special operations liaison element is provided by the joint force special operations component commander to coordinate and

synchronize special operations air and surface operations with joint air operations.

Naval and Amphibious Liaison Element

The naval and amphibious liaison element is provided by the naval component commander to act as the interface for matters pertaining to Navy and Marine Corps amphibious operations.

Marine Liaison Element

Although not doctrinal, some theater JFACCs include a Marine liaison element.

Air Mobility Element

The air mobility element provides detailed planning and coordination for all strategic airlift operations in theater.

Strategic Liaison Team

The strategic liaison team is provided by United States Strategic Command to assist the JFC and the JFACC in nuclear planning and coordination.

Air Force Liaison Team

The Air Force liaison team is provided by the commander, Air Force forces to act as the interface with the JFACC for coordinating and synchronizing Air Force units in support of joint air operations.

JTCB Marine Billet Descriptions

Component Representative

The component representative is the Marine who represents the MARFOR on the JTCB. The MARFOR representative receives the MARFOR target nominations and represents them at the JTCB. The MARFOR representative will be provided by the commander, MARFOR.

Component Representative Staff

The MARFOR component representative will have a small staff (three to four Marines) who will ensure the requisite communications connectivity is maintained with the MARFOR/MAGTF, and that the MARFOR/MAGTF target list is formatted and entered into the theater standard medium for review.

JAOC Marine Billet Descriptions

Senior Marine

The senior Marine is the senior ACE representative in the JAOC. The senior Marine will—

- Maintain liaison with the JFACC and his staff for effective presentation and adjudication of MARFOR aviation and targeting issues that are controlled or affected by the JFACC.

- Be directly responsible to the ACE commander.
- Be the focal point for all information passed from the Marine TACC's current operations, future operations, and future plans officers.
- Oversee and coordinate the efforts of Marine liaisons and augments assigned to the JAOC.

Assistant Combat Operations Officer (Combat Operations Division)

The assistant combat operations officer is an ACE augment that assists the JAOC combat operations officer as directed. The assistant combat operations officer will—

- Execute the ATO.
- Approve ATO changes.
- Keep the ACE battlestaff informed of the JFC/JFACC's latest objectives, priorities, and ROE.

Fighter Duty Officer (Combat Operations Division)

The fighter duty officer is an ACE augment to the JAOC combat operations division and works for the chief, combat operations division. The fighter duty officer will—

- Monitor, track, and task (prelaunch through the Marine TACC current operations, postlaunch through the applicable air control agency) all MAGTF aviation sorties designated as joint.

MCWP 3-25.4

- Pass any changes in tasking or requests for additional ACE fighter sorties to the Marine TACC current operations.
- Receive requests from the Marine TACC current operations for additional joint sorties and coordinate feedback results of request.
- Receive a copy of MAGTF/ACE aviation decision support products from the Marine TACC current operations to assist in monitoring the MAGTF plan.
- Maintain liaison with the Marine TACC's future operations for necessary adjustments in subsequent ATOs.

JSRC Liaison (Combat Operations Division)

The JSRC liaison is the MARFOR representative who maintains connectivity with the Marine TACC's current operations RCC. The JSRC liaison will—

- Maintain awareness of MAGTF-designated TRAP sorties planned in the ATO.
- Be the principal advisor to the JSRC director on MAGTF TRAP philosophies and concept, employment, and platform capabilities and limitations.
- Receive the search and rescue incident report messages from the Marine TACC's current operations RCC.
- Monitor the TRAP execution checklist.
- Ensure the required TRAP SPINS (e.g., execution checklist, communications plan) are included in the joint ATO.

Electronic Combat Representative (Combat Operations Division)

The electronic combat representative is an ACE augment who works in the JAOC combat operations division for the electronic combat duty officer. The electronic combat duty officer will—

- Coordinate, through the Marine TACC's current operations, all joint Marine Corps EA-6B sorties.
- Receive immediate requests for electronic combat aircraft support from the Marine TACC's current operations.
- Coordinate with the ACE electronic combat representative in the JAOC combat plans division and the Marine TACC future operations for all coordination issues on future tasking and requirements based on taskings that cannot be met on the executing ATO.
- Assist in integrating the electronic combat and air defense system suppression assets in support of mission objectives.
- Monitor execution of the current ATO to optimize ACE electronic combat support to the battle situation.
- Coordinate with intelligence analysts on current order of battle data and nominate immediate enemy C2 and communications targets.
- Assist in receiving and processing immediate electronic combat requests from US Air Force, joint, or combined forces and coordinate with the Army BCD and joint service LNOs for support requests.
- Coordinate with the JAOC airspace control section for airspace management of electronic combat assets.

MCWP 3-25.4

- Coordinate with the communications-electronics duty officer, the BCD, and the director of electronic combat for frequency deconfliction.
- Coordinate major electronic combat and deception plans and operations with the JAOC combat plans division and with the tactical deception officer.
- Recommend electronic combat initiatives to the JAOC combat plans division for other MAGTF requirements.
- Pass all joint electronic combat information to the Marine TACC's current operations.

Airspace Representative (Combat Operations Division)

The airspace representative is an ACE augment to the JAOC combat operations division and works for the airspace control duty supervisor. The airspace representative will—

- Serve as the conduit for the receipt of ACM requests from the Marine TACC's current operations airspace cell.
- Monitor and provide feedback to the Marine TACC's current operations airspace cell on any joint airspace issues that will affect ACE aircraft or air defense assets.
- Maintain access to the current MAGTF ACO and any SPINS updates to ensure that MAGTF requirements are met.
- Maintain liaison with the ACE augment to combat plans division/airspace plans to make necessary adjustments in subsequent ATO's.
- Coordinate with the JAOC frequency manager for frequency deconfliction.

- Post and update the JAOC airspace section maps with ACE ACMs.
- Monitor the ATO and ensure that joint sorties that support MAGTF forces are updated with MAGTF air control and airspace procedures through the fighter duty officer.
- Maintain liaison with ACE representatives in the JSRC, tanker branch, air defense section, and EW sections to ensure all assets are serviced with the applicable airspace requirement.

Air Defense Representative (Combat Operations Division)

The air defense representative is an ACE augment to the JAOC combat operations division and works for the senior air defense officer. The air defense representative will—

- Maintain situational awareness of ACE air defense assets in theater to include—
 - ACE air defense agency architecture.
 - Agencies and systems location.
 - Sector coverage.
 - Weapons conditions.
 - Alert status.
- Advise the senior air defense officer of ACE air defense system or platform employment philosophy, capabilities, and limitations.

MCWP 3-25.4

- Coordinate any changes in the ADP with the applicable air-space representatives.
- Serve as the conduit for any requests for change of assets or procedures in support of the MAGTF zone.
- Assist in requesting immediate (ground/aircraft) air defense assets to meet MAGTF requirements.

MAGTF BCD LNO

The MAGTF BCD LNO is the senior MAGTF ground liaison to the BCD and reports to the senior Marine. The MAGTF BCD LNO will—

- Maintain connectivity with the senior MAGTF fires section.
- Maintain copies of any decision support products produced by the MAGTF.
- Ensure FSCMs are coordinated, when requested, and, when approved, are implemented.
- Pass any changes of higher, adjacent, and/or supporting unit priorities to the MAGTF current operations.

MAGTF BCD Intelligence LNO

The MAGTF BCD intelligence LNO is the senior MAGTF intelligence representative in the JAOC and reports to the senior Marine. The MAGTF BCD intelligence LNO will maintain connectivity with the MAGTF G-2 and be the conduit for all intelligence information received from or disseminated to the MAGTF G-2.

Senior Marine Planner (Combat Plans Division)

The senior Marine planner is an ACE augment to the JAOC combat plans division and works for the director, combat plans. The senior Marine planner will—

- Maintain liaison with the JAOC senior Marine.
- Coordinate the activities of MAGTF liaisons to the combat plans division.
- Maintain connectivity with the Marine TACC's future operations ATO development section.
- Receive all decision support products from the ACE.
- Input the direct support ATO if the Marine TACC's ATO planning medium or software capability is degraded.
- Extract and provide to the joint aviation planning process the sorties and time on target of excess or directed MAGTF sorties.

Marine Aviation Planners (Combat Plans Division)

Marine aviation planners are provided by the ACE to support the joint ATO development process in the JAOC. Marine aviation planners will—

- Work for the senior Marine planner.
- Maintain connectivity with the Marine TACC's future operations ATO development section for the receipt of all MAGTF ACE decision support products (e.g., MAAP or SPINS).

MCWP 3-25.4

- Ensure MAGTF excess or directed sorties are entered into the theater ATO planning medium.
- Represent MAGTF aircraft platform capabilities, availability (in accordance with ACE flow plan), and integration into the joint aviation planning process (strike, CAS).
- Be prepared to enter the MAGTF direct support ATO into the joint planning medium if the Marine TACC's ATO production effort fails or is degraded.

Clerk (Combat Plans Division)

The combat plans clerk assists, as directed, the senior Marine planner in the JAOC combat plans division. The combat plans clerk will have a solid knowledge of the existing theater ATO planning medium or software.

Strategy Officer (Combat Plans Division)

The strategy officer is a MAGTF LNO, typically provided to the strategy board (implementation cell) at the JAOC. The strategy officer will—

- Assist in developing and refining the theater air strategy with MAGTF emphasis.
- Assist in developing and refining air objectives, prioritized tasks, and measures of effectiveness for each phase of the campaign.
- Keep the strategy board apprised of MAGTF aviation bed-down, force posturing, and force projection.

- Serve as the conduit for MAGTF information warfare requirements, including: electronic combat, psychological operations, special operations force, and tactical deception.

Marine Strategy Officer (Combat Plans Division)

The Marine strategy officer is an ACE liaison who reports to the senior Marine and works in the JAOC combat plans division (ATO production and development branch). The Marine strategy officer will—

- Assist in developing the JFACC daily guidance by providing MAGTF input.
- Review and assist in the JFACC apportionment recommendation.
- Receive the approved MAGTF apportionment recommendation from the Marine TACC's future operations officer.
- Assist in preparing the joint prioritized integrated target list.
- Receive and brief the ACE combat assessment from previous ATOs.
- Ensure seamless integration of the MAGTF information warfare plan into the joint targeting effort.

Marine Air Defense Planner (Combat Plans Division)

The air defense planner is an ACE liaison to the JAOC combat plans division (air defense branch). The air defense planner will—

- Be familiar with the MAGTF air defense asset laydown and concept of employment.

MCWP 3-25.4

- Assist in developing, coordinating, and promulgating theater ADPs and ROE with emphasis on the MAGTF zone of action.
- Maintain connectivity with the air defense planners in the Marine TACC's future operations ATO planning cell.
- Receive information from and promulgate information to the Marine TACC on all air defense issues: TACOPDAT, OPTASKLINK, air defense sectors, communication plan, CAP station management, etc.

Marine Airspace Management Planner (Combat Plans Division)

The airspace management planner is an ACE liaison to the JAOC combat plans division (airspace management branch). The airspace management planner will—

- Be familiar with the ACE laydown, concept of operations, and requirements as received from the airspace planner in the Marine TACC's future operations ATO planning cell.
- Coordinate the MAGTF airspace requirements for inclusion into the ACO and update with the SPINS.
- Be knowledgeable of the current automated airspace deconfliction/planning medium or software.
- Assist in planning and inclusion of all ACE inputs to the SPINS (e.g., communication plan, TRAP execution checklist, control agency check-in sequence).

AWACS Senior Marine LNO (Aviation Command Element)

The senior Marine Corps liaison aboard the Airborne Warning and Control System (AWACS) represents the ACE commander with the

JFACC aviation command element. He provides expertise on Marine Corps aviation tactical employment. The AWACS senior Marine LNO will—

- Maintain electronic connectivity with the Marine TACC's current operations SWO.
- Maintain copies of the ACE decision support products.
- Direct ACE direct support aviation activities with JFACC air command element assistance if the MACCS is significantly degraded or requires localized assistance.

AWACS Marine LNO (Aviation Command Element)

The Marine LNO aboard the AWACS is an ACE air defense representative to the JFACC airborne command element. He assists in air defense taskings or direction if the TAOC becomes a casualty, and MARFOR air defense assets (ground and air based) require control.

Additional Marine TACC Positions

During major theater wars the Marine TACC may require additional positions and/or cells to enhance the overall C2 capabilities of the ACE. The following paragraphs, not all encompassing, identify types of crew positions or cells that can be established due to the nature of the mission and related operational requirements.

Battle Captain

The battle captain is in many ways similar to the SWO, but he would be employed during large-scale (multiwing) operations. The battle captain would normally be an 0-6 aviator or C2 officer.

MCWP 3-25.4

The battle captain works directly for the commanding general and the chief of staff. They will attend commanding general's staff meetings/video teleconferences and supercede the SWO for the execution of the daily ATO within current operations.

Joint Issues Coordinator

The joint issues coordinator would be established during large-scale operations and he is responsible for coordinating ACE issues with higher aviation C2 agencies. For example, the joint issues coordinator during Operation Iraqi Freedom would coordinate the use of joint air assets with the CAOC. The joint issues coordinator will also provide the situational awareness of MAGTF air assets that support the overall joint ATO.

Air Tasking Order Manager

The air tasking order manager is also employed during large-scale operations. Their primary responsibility is to follow a single ATO from planning into execution and through assessment. They are the subject matter expert for a particular ATO and they can speak to why it was developed in a certain manner and how it can be adjusted to support emerging current operations.

Fraggers

The fraggers are comprised of a diverse cross section of Marine aviation (fixed wing, rotary wing, etc). They will monitor the status of MAG assets and will track the location of those assets whether they are at a FARP, a main air base, or operating from amphibious shipping. The fraggers serve as the subject matter experts for the employment of their aircraft type, model, and series and enable the efficient application of limited aviation assets.

Air Boss

The air boss, who in most cases is an aviator, is responsible for the overall operations at a particular FARP/FOB. The air boss works directly for the Marine TACC. All Marine wing support squadron and MACCS activities at a FARP/FOB location fall under the direction and authority of the air boss. They function as an extension of the Marine TACC and maintain a dialogue between the Marine TACC and aircrew in order to facilitate changes to the execution of the ATO. As directed by the Marine TACC, the air boss directs and prioritizes maintenance, ASRs, and other airfield activities to ensure aircraft launch, turnaround, and recover in a timely manner. The air boss will be a specific individual designated by the Marine TACC.

Electronic Warfare Control Center

The EW control center coordinates the EW efforts of not only MAGTF assets, but those joint assets that may fly in support of MAGTF operations. The EW control center will provide raw, real-time electronic intercepts and will effectively manage the ACE's limited EW assets. This cell is primarily manned by VMAQ aircrew or related staff.

Appendix C

Training

The training of the ACE battlestaff and Marine TACC crewmembers should be implemented and managed in accordance with the training management principles and guidance established in Marine Corps Order (MCO) 1553.3A, *Unit Training Management (UTM)*; MCRP 3-0A, *Unit Training Management Guide*; and MCRP 3-0B, *How to Conduct Training*. The primary tools for the conduct of training at the individual and unit level are the training and readiness (T&R) syllabus and its associated supporting software application, the Automated Training and Readiness Information Management System (ATRIMS).

Individual Training

Entry-Level Marine TACC Training

Marine TACC crewmembers are not identified by a unique military occupational specialty (MOS) designator. They are assigned from various air control, aviation, airfield services, intelligence, signals intelligence, and weather MOSs. They receive their training through related skills progression courses and managed on-the-job training in accordance with applicable individual training standards or T&R syllabi.

Most crew positions within the Marine TACC require skilled and experienced operators. ACE battlestaff personnel designated for the Marine TACC should be qualified in their respective specialty area or MOS. First tour personnel are not normally assigned to the Marine TACC.

Training and Readiness

The purpose of the Marine aviation T&R program is to provide the commander with standardized programs of instruction for all aviation personnel. The aviation T&R program provides policy for the development and standardization of all aviation T&R manuals. Aviation T&R manuals address—

- Aviation T&R program overview.
- Structure and organization for the construction of individual training syllabi.
- Training management and policies.
- Mission and instructor designation/qualifications, which identifies qualification and designation standardization policy.
- Core skill introduction training, which provides fleet replacement squadrons and entry-level schools training policy.
- Lists of all aviation T&R orders.
- Standardized T&R update and approval policy.

The goal of the T&R program is to implement a comprehensive, capabilities-based training system and not to measure individual proficiency. An effective T&R program is the first step in providing the MAGTF commander with an ACE capable of accomplishing any of its missions. The T&R program provides the fundamental tools for commanders to build and maintain unit combat readiness. Using these tools, unit training managers can construct and execute an effective training plan which supports the unit's mission-essential tasks (METs).

Core Competency

Core competency serves as the foundation of the T&R program. It is a collective term that entails requirements, capabilities, and information delineated in the applicable unit mission statement, mission-essential task list (METL), appropriate table of organization information, core capability statement, core model minimum requirements, and supporting tables such as METL/core skill matrix and qualification/designation tables. Core competency is a specific mission capability shared by Marines with the same MOS or by like units in the Marine Corps. It can be specifically defined by those individual or collective capabilities and skills that support those METs expected to be assigned in combat.

Mission-Essential Tasks

METs are those tasks a unit must be capable of performing in order to accomplish the unit mission, and these tasks focus individual and collective training. These tasks form a common baseline among like organizations and give the commander some initial requirements on which to base their training. Additional METs may be developed by the commander based on OPLANs, assigned missions, and taskers from higher headquarters. These unit-specific METs form the METL, which is a unit-specific, descriptive training document that provides the unit a clear, war-fighting-focused description of collective actions necessary to achieve wartime mission proficiency.

Core Capability

Unit core capability is a standardized measure of performance that a MAGTF commander should expect during sustained contingency/combat operations. The core capability for each MACCS squadron is described in individual T&R manuals.

Core Skills

Core skills are specific mission-related task areas that support a community's METL. Individuals must gain and maintain proficiency in core skills in order to execute unit core capability. Core skills consist of like T&R events and are normally delineated as T&R stage titles. Core skills are introduced in entry-level school training. Core skill training continues in a tiered approach through all phases of a T&R syllabus. Unit core skill proficiency is defined in terms of minimum numbers of crews required to be proficient in each core skill. Individual proficiency in a core skill requires an individual to attain and maintain proficiency per squadron T&R requirements.

Core Plus Skills

Core plus skills are those skills that have a high risk, low probability of execution or are considered theater specific. Core plus training is not considered essential to achieve unit core competency.

Marine TACC Training Progression

Each Marine TACC-specific T&R syllabus is based on a training progression model that provides training officers with a valuable tool for developing training plans (see fig C-1). The T&R syllabus depicts the logical progression of qualifications within the Marine TACC based on a crewmember's MOS experience level

and assigned crew position. The base of each model contains minimum qualifications necessary for assignment to the Marine TACC. The highest tier of the progression model contains qualifications held by only the most experienced personnel within a unit. A training officer's ability to produce viable training plans is enhanced by a clear delineation of qualification progression and an emphasis on the qualification of core skill basic and core skill advanced trained personnel. Units will use the model as a point of departure to generate weekly, monthly, quarterly, and annual training plans. The four phases of the training progression model are core skill introduction, core skill basic, core skill advanced, and core plus.

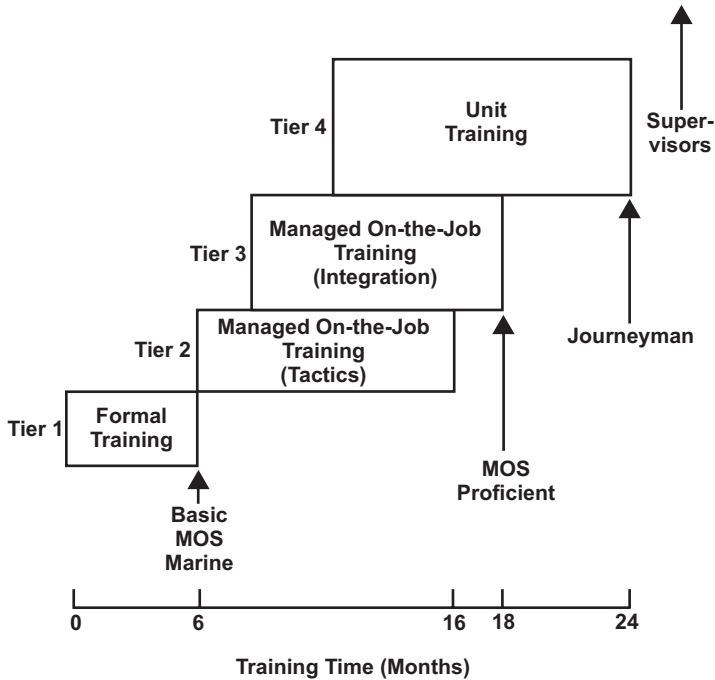

Figure C-1. Notional Training Progression Model.

Core Skill Introduction

The core skill introduction phase normally includes system/equipment operations familiarization, initial crew procedures, and initial exposure to core skills. This phase is accomplished at the crewmember's primary MOS training. At the completion of this phase, individuals are assigned to tactical units.

Core Skill Basic

The core skill basic phase contains core skill training essential to wartime employment of the unit systems. This phase should move an individual from basic understanding of core skills to proficiency in basic core skills of the assigned crew position in the Marine TACC. Personnel begin core competency training and start to develop critical operating skills after completion of this phase, personnel move to the core skill advanced phase.

Core Skill Advanced

The core skill advanced phase contains advanced core skill training. It includes the portion of the model that produces section coordinators and fully qualified crewmembers.

Core Plus

Core plus training events provide valuable training opportunities, but are not measured as part of unit SORTS [Status of Resources and Training System] reporting. This phase of training allows additional unit training flexibility.

Instructor or Specific Training

Marine TACC instructor training is not distinct from standard MOS training. It is a compilation of chosen events that qualifies a Marine to serve as an instructor for various levels of the T&R training phases.

In some cases, higher echelon supervisory position training and qualifications may be reflected where the development of a separate T&R syllabus is not practical or warranted. These personnel are the most experienced personnel within a unit.

MCO P3500.81, Aviation Training and Readiness (T&R) Manual, Tactical Air Command Center

The purpose of MCO P3500.81 is to provide a standardized program of instruction for all Marine TACC personnel. This enables commanders to develop and maintain individual unit combat readiness. This is achieved by following the syllabi contained in MCO P3500.81. Each syllabus is comprised of a series of lectures, live or simulator training events, and the proficiency interval associated with them. Additionally, each training event delineates the goal, requirements, and performance standards necessary to ensure proper training of Marine TACC personnel. Events may be chained to other events within each syllabus. MCO P3500.81 contains syllabi for TACC officer MOS 72XX and MOS 75XX as well as the TACC enlisted operator, MOS 72XX. Syllabi for the TACC intelligence officer (MOS 02XX) and TACC intelligence analyst (MOS 02XX) can be found in their respective training manuals.

Combat Readiness Percentage

Combat readiness percentage (CRP) is that percentage of a specific tactical aircraft/MACCS syllabus in which personnel are proficient. Four basic categories divide CRP into a total percentage of proficiency that personnel have demonstrated within their respective syllabi as shown below:

- Core skill introduction (60 percent CRP; 100 training level).
- Core skill basic (75 percent CRP; 200 training level).
- Core skill advanced (95 percent CRP; 300 training level).
- Core plus (100 percent CRP; 400 training level).

ATRIMS

ATRIMS is a special purpose training management tool designed specifically for training management in MACCS units. Currently, ATRIMS is designed to automate the use of Marine TACC T&R syllabi as a training management and decision support tool for the commander and trainer. ATRIMS provides the ability to store and track data related to Marine TACC crew member training and is capable of producing reports to effectively manage the training effort. Reports include summaries of live and simulated training time; qualifications obtained for individual crewmembers; greaseboard summary of all T&R events completed; CRP by individual, crew, or agency; academic training completed; individual deployed time; and a transfer data utility and summary that allows the merge of training records between ATRIMS databases.

ACE Battlestaff Training Responsibility

The Marine aircraft wing G-3 is responsible for the assignment of individuals to and the combat readiness of the ACE battlestaff. Marines assigned to the ACE battlestaff shall demonstrate proficiency in accordance with the mission qualifications and designations listed in the applicable T&R syllabus in MCO P3500.81.

Commanding Officer, Marine Tactical Air Command Squadron

The commanding officer, MTACS, shall ensure that the requisite Marine TACC training for MACG-assigned Marines is accomplished in accordance with the applicable T&R syllabus in MCO P3500.19B, *Aviation Training and Readiness Manual, Volume V, Marine Air Command and Control System (MACCS)*.

Wing G-2

The Marine aircraft wing G-2 shall ensure that the requisite Marine TACC training for Marines assigned to the wing G-2 or ACI is accomplished in accordance with the applicable T&R syllabus in MCO P3500.19B and the intelligence T&R manual.

Wing Battlestaff Trainer

The wing battlestaff trainer shall ensure that the requisite training for Marines assigned to other Marine aircraft wing organizations is accomplished in accordance with the applicable T&R syllabus in MCO P3500.19B.

Training management of the ACE battlestaff and reporting of CRP is the responsibility of the designated wing battlestaff

MCWP 3-25.4

trainer. The commanding officer, MTACS, and wing G-2 will submit ATRIMS transfer data records of crewmember training to the wing battlestaff trainer for merging and reporting to the wing commanding general on a quarterly basis.

Weapons and Tactics Instructor Course

The Weapons and Tactics Instructor Course consists of approximately 6 weeks of academics, C2 integration, and flight instruction. Conducted twice annually, it is designed to provide one weapons and tactics instructor per squadron or unit per year. The object is to graduate officers who are fully qualified in their MOS and who are capable of planning and executing air-ground missions. During the course, weapons and tactics instructor students refine their instructional abilities and hone aviation planning and execution skills during high-intensity, integrated tactical exercises.

Marine TACC-Related Courses of Instruction

Senior Watch Officer Course

Sponsored by Marine aviation weapons and tactics squadron-1, the SWO course is designed to familiarize senior aviators and C2 officers with MACCS agencies and equipment. The course is designed to enhance the commander's knowledge and ability to conduct combat operations within the context of the six functions of Marine aviation and function as a SWO or possibly battle captain during Marine TACC operations.

ACE Battlestaff Officer's Course

Sponsored by Marine aviation weapons and tactics squadron-1, the ACE Battlestaff Officers Course has been developed for naval

aviators or naval flight officers who are now serving or have the potential to serve in the Marine TACC. The course is designed to enhance knowledge of the MACCS and the ATO development process. Students will develop the ATO using TBMCS. After ATO development, the students will execute the ATO within the Marine TACC's current operations.

Multi-TADIL Advanced Joint Interoperability Course

The Multi-TADIL Advanced Joint Interoperability Course, sponsored by United States Army Forces Command, provides detailed information on TADIL operations and management and tactical data systems used by the Services. The course trains students in jointly approved concepts, doctrine, procedures, and techniques for integrating, operating, and managing multiple TADILs in joint operations.

Joint Tactical Information Distribution System Course

Sponsored by United States Army Forces Command, the Joint Tactical Information Distribution System (JTIDS) Course provides training in joint planning, employment, operating procedures, and systems capabilities of JTIDS.

AOC Initial Qualification Training, Offensive Course

This course trains personnel, O5 and below, who are assigned to an AOC weapon system or augmenting manpower forces unit how to perform offensive combat plans/operations duties in a JAOC. Personnel receive education and training on joint and Service doctrine; JAOC organization and processes; ABP development; ATO production and execution; operational assessment; and TBMCS applications and other associated AOC C2 systems

MCWP 3-25.4

tools. Training consists of academic lectures, seminars, computer application labs, practical exercises, and a comprehensive end-of-course exercise simulating a JAOC environment.

AOC Initial Qualification Training, Defensive Course

This course trains personnel, O5 and below, who are assigned to an AOC weapon system or augmenting manpower forces unit how to perform defensive combat plans/operations duties in a JAOC. Personnel receive education and training on joint and Service doctrine; JAOC organization and processes; ATO air defense planning, coordination and execution; and TBMCS applications and other associated AOC C2 systems tools. Training consists of academic lectures, seminars, computer application labs, practical exercises and a comprehensive end-of-course exercise simulating a JAOC environment.

Air and Space Operations Center Familiarization Course

This course familiarizes personnel, O-5 and below, on the command and control of air and space power at the operational level of war. The course covers the basic fundamentals of joint and Service doctrine and organization for combat, theater air ground system, JAOC organization, processes and systems, and the ATO cycle.

Joint Air Operations Staff Course

Sponsored by the US Air Force Air Ground Operations School, JAOSC focuses on battle management functions performed to integrate air and surface resources into joint combat operations. It provides an understanding of fundamental coordination considerations performed primarily at an AOC or an associated joint or component facility. The course covers threat; basic doctrine,

mission, and organization of the Services; command, control, and communications system; intelligence support capabilities; tactical missions and major weapons systems used in joint operations; capabilities and limitations of C2W concepts or strategy; and current TBMCS computer tools used in joint operations.

Crew and Agency Training

Marine Aviation Planning Program

The Marine aviation planning program (MAPP) is a low-cost, low-overhead training exercise that portrays military situations on maps and overlays that may be supplemented with or replaced by, terrain models and sand tables. MAPP allows commanders to train their staffs to perform tactical planning, special integration, and control functions to support decisions under simulated combat conditions. They are suitable for C2 training from the Marine aircraft wing level down to agency, crew, or section level. MAPP is especially useful for multi-echelon staff training when commanders desire minimum personnel yet strive to exercise staff planning procedures and techniques.

MISTEX

The main objective of the Marine air command and control system (MACCS) integrated system training exercise (MISTEX) is to bring the MACG together as a fully capable MACCS for employment. MISTEXs should focus on the establishment of necessary communications and data links between MACCS agencies and incorporate sufficient simulation and master scenario events list items to exercise and analyze system integration, crew

MCWP 3-25.4

coordination, and critical information flow wherever possible. The greatest benefit derived from a MISTEX program is integrated training at the system level. This does not imply that subordinate units cannot benefit from the program. Individual units not only receive the benefit of systems training, but small-unit and individual training objectives can be met.

Joint Service Training Exercise

Sponsored by the United States Army Forces Command, joint Service training exercises provide integrated systems training that emphasizes data link operations in the joint arena. Joint Service training exercises validate interoperability concepts and tactics and provide a unique training opportunity without excessive cost.

Marine Air Command and Control System Performance Record

The MACCS performance record (see Navy/Marine Corps Departmental Publication [NAVMC] 2898, *MACCS Performance Record [Jackets]*) is a tool designed to consolidate MOS-applicable training credited to an individual Marine in a single-source document. When used in conjunction with the ATRIMS, the MACCS performance record can provide a unit commander with a comprehensive record of the capability, experience, and weaknesses of a newly joined Marine or effectively track the progress of Marines during their assignments within the Marine air C2

squadron. The MACCS performance record consists of the following sections:

- Section I. Administrative information.
 - Privacy act statement.
 - Record of audit.
 - Formal training records.
- Section II. MOS training qualifications.
 - MOS qualification records.
 - Designation certificates.
- Section III. Managed on-the-job training.
 - Training summary.
 - T&R syllabus event evaluations.
 - Academic training records.
 - Training time summary.
 - Transfer data summary.
- Section IV. General training information.
 - Individual deployment records or information.
 - Professional military education or Marine Corps Institute records.
 - General information or miscellaneous.

The Systems Approach to Training

The Systems Approach to Training (SAT) is a dynamic, flexible, system for developing and implementing effective and efficient training to meet current and projected needs. This process is made up of five distinct phases, each serving a specific purpose.

Analyze Phase

- Review Marine Corps doctrine:
 - Campaign plans.
 - Contingency plans.
 - Table of organization mission statement for type of units.
 - Combat plans.
- Review higher headquarters, supported unit, and supporting unit METLs.
- Determine all specified and implied tasks for all units.
- Select METL.

Design Phase

- Relate METs to MPSs.
- List collective and individual tasks for subordinate units and Marines that support METL tasks.
- Evaluate or assess unit strengths and deficiencies.
- Prioritize training of METs.
- Design appropriate training plans for units and individuals.
- Ensure that all training tasks or objectives are stated as performance, condition, and standards statements.

Develop Phase

- Develop training materials and secure support.
- Train the trainers.
- Staff rehearsal of training plans and lesson plans.

Implement Phase

- Implement training plans.
- Conduct battle staff exercises, unit exercises, field training exercises, drills, and individual training.

Evaluate Phase

- Conduct internal after-action reviews.
- Review external evaluation feedback.
- Review training deficiencies of subordinate units/individuals.
- Reprioritize tasks in training plans based on assessment of deficiencies.
- Conduct evaluation during all phases.

SAT is a continuous, cyclical process that allows any one of the five phases to occur at any time. In addition, each phase within SAT further builds upon the previous phase, providing a system of checks and balances to insure all instructional data are accounted for and that revisions to training are identified and made. Figure C-2, on page C-18, provides an overview of the SAT process.

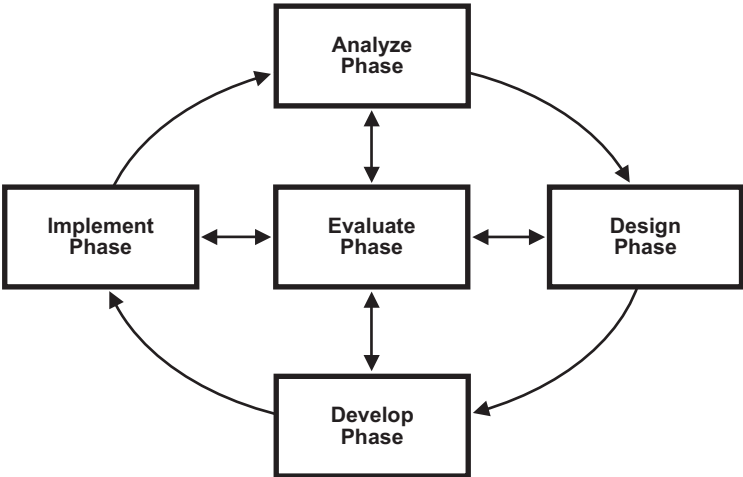

Figure C-2. SAT Overview.

Appendix D

Marine TACC Communications Nets

Voice and data circuits (to include SATCOM) employed by the Marine TACC are presented in this appendix. The ACE G-3 may choose to combine nets based on operational requirements or asset limitations. Nets can be combined whenever original net functions can still be accomplished and the net is not overloaded.

Marine TACC Voice Nets

MAGTF Tactical Net 1 (VHF/UHF-SATCOM/HF)

Provides the primary path for operational traffic between the CLF and the major combat elements of the MAGTF.

MAGTF Tactical Net 2 (HF/UHF-SATCOM)

Same as the MAGTF tactical net 1; established when warranted by volume of traffic.

MAGTF Tactical Air Command Net (UHF-SATCOM/HF)

Provides the means by which the MAGTF commander and the ACE commander coordinate air tasking and air apportionment decisions and task and supervise the execution of the six functions of Marine aviation.

MAGTF Command Net 1 (HF/UHF-SATCOM)

Provides a means for the MAGTF commander to exercise command and coordinate administrative and logistic functions with the major components of the MAGTF.

MAGTF Command Net 2 (HF/UHF-SATCOM)

Same as MAGTF command net 1; established when warranted by volume of traffic.

MAGTF Alert/Broadcast Net (UHF-SATCOM/HF)

Provides a means for rapidly passing alert warning information of any character. It may be used for transmitting all types of traffic.

MAGTF Intelligence Net (HF/UHF-SATCOM/VHF)

Provides a path for rapid collection and dissemination of intelligence between the CLF and the major combat elements of the MAGTF.

MAGTF Communications Information Systems Coordination Net (UHF/SATCOM/HF)

Provides higher headquarters a means for coordinating, installing, and restoring communications circuits with MSCs within the area of operations.

ACE Tactical Air Command Net 1 (HF/UHF-SATCOM)

Provides the primary means by which the TAC tasks subordinate elements to perform the six functions of Marine aviation.

ACE Command Net (HF)

Provides a means for the ACE commander to exercise command and coordinate administrative and logistic functions with subordinate units.

ACE Intelligence Net (HF/VHF)

Provides a means for rapidly collecting and disseminating intelligence information.

ACE Communications Information Systems Coordination Net (HF)

Provides a means for coordinating, installing, and restoring communications circuits.

Direct Air Support Net (HF/Multichannel Radio)

Provides a means for the DASC to request direct air support aircraft from the Marine TACC. Information pertaining to aircraft stationing, fuel and ordnance status, progress of direct air support missions, etc., may be passed over this net.

Tactical Air Request/Helicopter Request Net (HF/VHF)

Provides a means for forward ground combat units to request immediate air support from the DASC. Intermediate ground combat echelons monitor this net and may modify, disapprove, or approve a specific request. The DASC uses the net to brief the requesting unit on the details of the mission. Target damage assessments and emergency helicopter requests may be passed over this

MCWP 3-25.4

net. Multiple tactical air request/helicopter request (TAR/HR) nets may be required, depending on the scope of CAS operations.

Tactical Air Traffic Control Net (UHF/VHF)

Provides a means for the Marine TACC, TADC, TAOC, and DASC to exercise control of all tactical and itinerant aircraft in the area of operations. Information passed over this net includes aircraft reports of launches by mission number, aircraft clearances to their assigned control agencies, aircraft diversions as necessary, and aircraft completed mission reports prior to landing. Multiple tactical air traffic control nets are required, with the Marine TACC, TADC, TAOC, and DASC each having its own net.

Tactical Air Direction Net (UHF/VHF)

Provides a means for the direction of aircraft in the conduct of offensive air support missions and for the DASC to brief support aircraft on target information or assignment to a terminal controller. Multiple tactical air direction nets are required and are assigned to major air control agencies.

Air Operations Control Net (HF/Multichannel Radio)

Provides a means for the TAOC to request interceptor aircraft and to report friendly air defense situation information to the Marine TACC and TADC. Information pertaining to CAP availability, stationing, and assignment; assignment and disposition of targets; intercept progress; surface-to-air missile unit status; and employment and aircraft or missile weapons coordination is passed on this net. Multiple air operations center nets are normally required with one or more nets being established for each TAOC in operation.

Command Action Net (Multichannel Radio/HF/VHF)

Provides a means for command-level coordination of antiair warfare through the exchange of information pertaining to missile battery employment, assignment of air targets, and interceptor or missile coordination. Net functions may be performed over the air operations control net when multichannel radio circuits are not established.

Combat Identification/Direction Net (HF/Multichannel Radio)

Provides a means for reporting an unidentified or hostile aircraft, including initial contact reports, tracking, amplifying, and final disposition reports. Multiple combat identification or detection nets may be employed and are assigned to appropriate radar surveillance activities, as required.

Search and Rescue Net (UHF/HF)

Provides a means for the control and coordination of air rescue missions. Multiple search and rescue nets may be required, depending on the number of current search and rescue missions.

Voice Product Net (Multichannel Radio/HF/UHF)

Provides a means to forward nondigital SIGINT information to other interfacing units.

Guard Net (UHF/VHF)

Provides an emergency distress net used by aircraft to declare an emergency. It further serves as a means for air control agencies to advise aircraft of emergency conditions or serious hazards to aircraft safety.

Data Link Coordination Net (Multichannel Radio/HF/UHF)

Provides a means for maintenance coordination of data link operation. May be combined with the track supervision net for single-channel operations. Generally, there is one such net per TADIL B circuit.

Track Supervision Net (Multichannel Radio/HF/UHF)

Provides a means for track surveillance personnel to exchange voice information to maintain a clear air picture. This net may assume the function of the data link coordination net based on equipment and channel availability.

Air Defense Command and Control Net (HF/UHF/VHF/Multichannel Radio)

Provides a means for command-level coordination of tactical weapons and for interface command, control, and coordination.

Data Links

Tactical Data Link A (HF/UHF)

A half-duplex, netted link that provides a means for exchanging automatically processed digital data between various tactical data systems. Types of data passed include air and surface tracks, weapons status, and selected orders and functions. North Atlantic Treaty Organization (NATO) designation: Link 11.

Tactical Data Link B (Multichannel Radio/Landline/HF/UHF/SATCOM)

A full-duplex, point-to-point link that operates with continuous transmissions over a variety of media, including SATCOM, single-channel radio or multichannel radio links. Tactical data link B provides a functional equivalent to tactical data link A. NATO designation: Link 11B.

NATO Link-1 (Multichannel Radio)

Provides interface to NATO air defense ground environment agencies in a point-to-point mode using full-duplex data link.

Link 16 (UHF)

A nodeless, high-capacity, multifunctional, secure, jam-resistant tactical data link designed for the exchange of fixed format and voice messages using the Joint Tactical Information Distribution System (JTIDS) Class 2 or MIIDS [Military Intelligence Integrated Data System] terminal. Link 16 is UHF requiring line of sight between participating units. However, beyond line-of-sight capabilities exist to push Link 16 over SATCOM transmission control protocol/internet protocol or serial/telephone paths.

Tactical Intelligence Broadcasts

Tactical Information Broadcast Service

Provides a capability to disseminate correlated, time-sensitive tactical information to joint operational users via UHF broadcasts

MCWP 3-25.4

from aircraft or fleet SATCOM system. Current sources of data can include the following:

- RC-135 RIVET JOINT.
- Joint Surveillance Target Attack Radar System.
- AWACS.
- SENIOR TROUPE.
- SENIOR SCOUT.

Tactical Related Applications

Provides a capability to collect information from multiple sources and disseminate it through a UHF SATCOM broadcast to tactical users. TRAP provides global surveillance information for sensor cueing and integration into databases at the various field receive locations. Data is forwarded from sensor to processor to communications gateways or relays to one of the fleet SATCOM broadcast satellites for worldwide dissemination to military users.

Tactical Data Information Exchange System B

Provides a capability to process and distribute nationally generated tactical data to operational forces in support of indications and warning, sensor cueing, and user mission planning.

Communications Guard Charts and Terminal Equipment Locations

The following table contains recommended ACE communications guard chart information with suggested terminal equipment

locations. The actual assignment of communications nets and terminal equipment locations will vary based on the ACE commander's mission, enemy, terrain and weather, troops and support available—time available analysis.

Note: Individual tactical air traffic control nets are assigned to specific agencies by the G-6.

MCWP 3-25.4

Communications Guard Chart.

Voice Nets	Agencies						
	MEF	Marine TACC	TAOC	EW/C	MAGs	ATC Dets	DASC
MAGTF TAC 1	C	X					
MAGTF TAC 2	C R	R					
TAC air Command 1	C	R	X R	R	R	R	R
MAGTF Command 1	C	X					
MAGTF Command 2	C R	R					
MAGTF Alert	C	X					
MAGTF Intelligence	C	X					
MAGTF C/ISC	C	C*					
ACE TAC 1		C	X	X	X	X	
ACE Command		C	R	R	X	R	R
ACE Intelligence		C	X	R	X	R	X
ACE C/ISC		C*	X	X		X	X
DAS		C					X
TAR/ HR		R					C
Tactical air traffic control net		C R	C R	C R		C R	C R
Tactical air direction							C
Air operations centers 1-4		C	X	R			
Command action		C	X	X			
Combat identification/ direction net		R	C	X		X	R
Search and rescue		C	X	X	X	X	X
Voice product net		C	R	R			
Guard		X	X	X	X	X	X
Data link coordination net		C	X	X		X	
Track supervision net		C	X	X		X	
Air defense C2I net		C	X				

* MWCS - Marine wing communications squadron

ATC - air traffic control
C - net control station

C/ISC - communications/
information systems
coordination net

D - detachments
R - as required
X - guard

Appendix E

Glossary

Section I. Acronyms and Abbreviations

AADC	area air defense commander
ABP	air battle plan
ACA	airspace control authority
ACE	aviation combat element
ACI	air combat intelligence
ACM	airspace control measure
ACO	airspace control order
ACP	airspace control plan
AD	airspace deconfliction
ADP	air defense plan
AFATDS	Advanced Field Artillery Tactical Data System
AIRSUPREQ	air support request
ALD	aviation logistics division
ALLOREQ	allocation request
AODB	air operations database
ASR	assault support request
ATO	air tasking order
ATRIMS	Automated Training and Readiness Information Management System
AWACS	Airborne Warning and Control System
BCD	battlefield coordination detachment
BDA	battle damage assessment
C2	command and control
C2PC	command and control PC

MCWP 3-25.4

CAC2S.....	Common Aviation Command and Control System
CAOC.....	combined air operations center
CAP.....	combat air patrol
CAS.....	close air support
CATF.....	commander, amphibious task force
CBRN.....	chemical, biological, radiological, and nuclear
CE.....	command element
CLF.....	commander, landing force
COA.....	course of action
COMINT.....	communications intelligence
CRP.....	combat readiness percentage
CSAR.....	combat search and rescue
CTT3.....	commander's tactical terminal, three channel
DAS.....	deep air support
DASC.....	direct air support center
ECU.....	environmental control unit
ELINT.....	electronic intelligence
EM.....	execution management
EMC.....	execution management control
EMR.....	execution management replanner
EW.....	electronic warfare
EW/C.....	early warning/control
FARP.....	forward arming and refueling point
FFCC.....	force fires coordination center
FOB.....	forward operating base
FRAGO.....	fragmentary order
FSCL.....	fire support coordination line
FSCM.....	fire support coordination measures

G-1	brigade or higher manpower/personnel/ administrative office/officer
G-2	brigade or higher intelligence office/officer
G-3	brigade or higher staff operations/training office/officer
G-4	brigade or higher staff logistics office/officer
G-6	brigade or higher staff communications and information systems office/officer
GCCS	Global Command and Control System
GCE	ground combat element
GI&S	geospatial information and services
HF	high frequency
HMD DASC	high mobility downsized direct air support center
HR	helicopter request
IAS	intelligence analysis system
IDM	intelligence data management
IM	imagery management
INTREP	intelligence report
INTSUM	intelligence summary
IPB	intelligence preparation of the battlespace
ISO	International Organization for Standardization
JAOC	joint air operations center
JFACC	joint force air component commander
JFC	joint force commander
JP	joint publication
JSRC	joint search and rescue center
JTAR	joint tactical air strike request
JTCB	joint targeting coordination board

MCWP 3-25.4

JTF	joint task force
JTIDS	Joint Tactical Information Distribution System
LCE	logistics combat element
LNO	liaison officer
MAAP	master air attack plan
MACCS	Marine air command and control system
MACG	Marine air control group
MAG	Marine aircraft group
MAGTF	Marine air-ground task force
MAGTF II	Marine Air-Ground Task Force War Planning System II
MAPP	Marine aviation planning program
MARFOR	Marine Corps forces
MCESS	Marine Corps Expeditionary Shelter System
MCO	Marine Corps order
MCPP	Marine Corps Planning Process
MCRP	Marine Corps reference publication
MCWP	Marine Corps warfighting publication
MEF	Marine expeditionary force
MEP	mobile electric power
MERWS	modular extendable rigid wall shelter
MET	mission-essential task
METL	mission-essential task list
MEU	Marine expeditionary unit
MIDB	modernized integrated database
MISTEX	Marine air command and control system (MACCS) integrated simulated training exercise
MOS	military occupational specialty
MSC	major subordinate command
MTACS	Marine tactical air command squadron

Marine TACC Handbook

NATO	North Atlantic Treaty Organization
NAVMAC	Navy/Marine Corps departmental publication
OAAW	offensive anti-air warfare
OODA	observe, orient, decide, act
OPLAN	operation plan
OPORD	operation order
OPT	operational planning team
OPTASKLINK	operations task link
PDE&A	planning, decision, execution, and assessment
PIR	priority intelligence requirement
RAAP	rapid application of air power
RCC	rescue coordination cell
RFI	request for information
ROE	rules of engagement
S-3	battalion or regiment operations/ training officer/office/section
SAA	situation awareness and assessment
SAC	senior air coordinator
SADF	sector air defense facility
SAT	Systems Approach to Training
SATCOM	satellite communications
SIGINT	signals intelligence
SORTIEALOT	sortie allotment message
SPINS	special instructions
SWO	senior watch officer
T&R	training and readiness
TAC	tactical air commander

MCWP 3-25.4

TACC.....	tactical air command center (USMC); tactical air control center (USN)
TACOPDAT	tactical operational data
TADC	tactical air direction center
TADIL	tactical digital information link
TAOC	tactical air operations center
TAP.....	theater air planner
TAR	tactical air request
TBMCS	theater battle management core system
TERPES.....	tactical electronic reconnaissance processing and evaluation system
TNL	target nomination list
T&R.....	training and readiness
TRAP	tactical recovery of aircraft and personnel
TSCIF	tactical sensitive compartmented information facility
TWM	targeting and weaponeering module
UAS	unmanned aircraft system
UHF	ultrahigh frequency
VAC	volts, alternating current
VHF	very high frequency
VMAQ.....	Marine tactical electronic warfare squadron

Section II. Definitions

air boss—The single point of contact at an air facility, responsible to the aviation combat element G-3, who coordinates all activities at an air facility and is the primary interface with the tactical air command center. The air boss is responsible for synchronizing the operations of fuel, ordnance, maintenance, and ground support activities to execute the missions tasked in the daily air tasking order (ATO). Additionally, the air boss is responsible for recommending changes to the ATO based on changes in the status of operations at the air facility and adjusting the operations at the air facility to meet changes in the ATO.

air combat intelligence—That portion of the tactical air command center and aviation combat element commander's battle-staff responsible for the production of aviation-specific all-source intelligence and its dissemination throughout the tactical air command center. Also called **ACI**.

air control—1. The authority to effect the maneuver of aircraft. The elements of air control are: air control agency, air controller, airspace control, operational control, positive control, procedural control, radar control, and terminal control. 2. The authority to direct the physical maneuver of aircraft in flight or to direct an aircraft or surface-to-air weapon unit to engage a specific target. (MCRP 5-12C)

air control agency—An organization possessing the capability to exercise air control. (MCRP 5-12C)

air direction—1. The guidance and supervision that a commander employs to focus his resources on mission accomplishment. 2. The authority to regulate the employment of air resources (aircraft and surface-to-air units) to maintain a balance between their availability and the priorities assigned for their usage. 3. Air direction occurs as a sequence of the following activities: apportionment, allocation, tasking, and fragmentary orders.(MCRP 5-12C)

air reconnaissance—The acquisition of information by employing visual observation and/or sensors in air vehicles. (JP 1-02)

airspace control authority—The commander designated to assume overall responsibility for the operation of the airspace control system in the airspace control area. Also called **ACA**. (JP 1-02)

airspace control order—An order implementing the airspace control plan that provides the details of the approved requests for airspace coordinating measures. It is published either as part of the air tasking order or as a separate document. Also called **ACO**. (JP 1-02)

airspace control plan—The document approved by the joint force commander that provides specific planning guidance and procedures for the airspace control system for the joint force operational area. Also called **ACP**. (JP 1-02)

airspace management—The coordination, integration, and regulation of the use of airspace of defined dimensions. (JP 1-02)

area of operations—An operational area defined by the joint force commander for land and naval forces. Areas of operation do not typically encompass the entire operational area of the joint

force commander, but should be large enough for component commanders to accomplish their missions and protect their forces. Also called **AO**. (JP 1-02)

area of responsibility—The geographical area associated with a combatant command within which a geographic combatant commander has authority to plan and conduct operations. Also called **AOR**. (JP 1-02)

battlespace—All aspects of air, surface, subsurface, land, space, and electromagnetic spectrum that encompass the area of influence and area of interest. (MCRP 5-12C)

combat assessment board—A board formed within the tactical air command center designed: 1) to provide recommended process improvements in tactics, techniques, procedures, ordnance, countermeasures equipment/expendables, etc.; 2) to share its outputs with all other units in the joint/combined effort through the operational chain of command; and 3) to stimulate government labs, industry, and the procurement process into developing rapid solutions to real/critical problems.

command and control—The exercise of authority and direction by a properly designated commander over assigned and attached forces in the accomplishment of the mission. Command and control functions are performed through an arrangement of personnel, equipment, communications, facilities, and procedures employed by a commander in planning, directing, coordinating, and controlling forces and operations in the accomplishment of the mission. Also called **C2**. (JP 1-02)

decentralized control—In air defense, the normal mode whereby a higher echelon monitors unit actions, making direct

target assignments to units only when necessary to ensure proper fire distribution or to prevent engagement of friendly aircraft. (JP 1-02) In military operations, a mode of battlespace management in which a command echelon may delegate some or all authority and direction for warfighting functions to subordinates. It requires careful and clear articulation of mission, intent, and main effort to unify efforts of subordinate leaders. (MCRP 5-12C)

direct air support center—The principal air control agency of the US Marine air command and control system responsible for the direction and control of air operations directly supporting the ground combat element. It processes and coordinates requests for immediate air support and coordinates air missions requiring integration with ground forces and other supporting arms. It normally collocates with the senior fire support coordination center within the ground combat element and is subordinate to the tactical air command center. Also called **DASC**. (JP 1-02)

intelligence preparation of the battlespace—The systematic, continuous process of analyzing the threat and environment in a specific geographic area. Also called **IPB**. (MCRP 5-12C)

joint operation—An operation carried on by a force that is composed of significant elements of the Army, the Navy or the Marine Corps, and the Air Force, or two or more of these Services operating under a single commander authorized to exercise unified command or operational control over joint forces. *Note: A Navy/Marine Corps operation is not a joint operation.*

Marine air command and control system—A system that provides the aviation combat element commander with the means to command, coordinate, and control all air operations within an

assigned sector and to coordinate air operations with other Services. It is composed of command and control agencies with communications-electronics equipment that incorporates a capability from manual through semiautomatic control. Also called **MACCS**. (JP 1-02)

procedural control—A method of airspace control which relies on a combination of previously agreed and promulgated orders and procedures. (JP 1-02)

rules of engagement—Directives issued by competent military authority that delineate the circumstances and limitations under which United States forces will initiate and/or continue combat engagement with other forces encountered. Also called **ROE**. (JP 1-02)

tactical air command center—The principal US Marine Corps air command and control agency from which air operations and air defense warning functions are directed. It is the senior agency of the US Marine air command and control system that serves as the operational command post of the aviation combat element commander. It provides the facility from which the aviation combat element commander and his battle staff plan, supervise, coordinate, and execute all current and future air operations in support of the Marine air-ground task force. The tactical air command center can provide integration, coordination, and direction of joint and combined air operations. Also called **Marine TACC**. (JP 1-02)

tactical air control center—The principal air operations installation (ship-based) from which all aircraft and air warning functions of tactical air operations are controlled. Also called **Navy TACC**. (JP 1-02)

MCWP 3-25.4

tactical air direction center—An air operations installation under the overall control of the Navy tactical air control center (afloat)/Marine Corps tactical air command center, from which aircraft and air warning service functions of tactical air operations in support of amphibious operations are directed. Also called **TADC**. (JP 1-02)

Appendix F

References

Joint Publications (Joint Pubs)

- 3-13 Information Operations
- 3-13.1 Electronic Warfare

Navy/Marine Corps Departmental Publication (NAVMC)

- 2898 MACCS Performance Record (Jackets)

Marine Corps Warfighting Publications (MCWPs)

- 3-2 Aviation Operations
- 3-22 Antiair Warfare
- 3-25 Control of Aircraft and Missiles
- 3-25.3 Marine Air Command and Control System Handbook
- 3-25.8 Marine Air Traffic Control Detachment Handbook
- 5-11.1 MAGTF Aviation Planning

Marine Corps Reference Publications (MCRPs)

- 3-0A Unit Training Management Guide
- 3-0B How to Conduct Training
- 5-11.1A MAGTF Aviation Planning Documents
- 5-12C Marine Corps Supplement to the DOD Dictionary of Military and Associated Terms

Marine Corps Orders (MCOs)

- 1553.3A Unit Training Management (UTM)
- 3500.14 Aviation Training and Readiness (T&R) Program
- P3500.19B Aviation Training and Readiness Manual,
Volume V, Marine Air Command and Control
System (MACCS)
- P3500.81 Aviation Training and Readiness (T&R) Manual,
Tactical Air Command Center