

**ATP 4-44
MCRP 3-40D.14
(Formerly MCRP 3-17.7Q)**

Water Support Operations

October 2015

DISTRIBUTION RESTRICTION A: Approved for public release; distribution is unlimited.

SUPERSESSSION STATEMENT: This publication supersedes FM 10-52 dated 11 July 1990, FM 10-52-1 dated 18 June 1991, and FM 10-115 dated 15 February 1989.

Headquarters Department of the Army

PCN 144 000196 00

CD&I (C 116)

2 May 2016

ERRATUM

to

MCRP 3-17.7Q

WATER SUPPORT OPERATIONS

1. Change all instances of MCRP 3-17.7Q, *Water Support Operations*, to MCRP 3-40D.14, *Water Support Operations*.
2. File this transmittal sheet in the front of this publication.

PCN 144 000196 80

This publication is available at Army Knowledge Online
(<https://armypubs.us.army.mil/doctrine/index.html>).
To receive publishing updates, please subscribe at
http://www.apd.army.mil/AdminPubs/new_subscribe.asp

Army Techniques Publication
No. 4-44
Marine Corps Reference Publication
No. 3-17.7Q

Headquarters
Department of the Army
Washington, DC, 2 October 2015
Marine Corps
Combat Development Command
Quantico, VA, 2 October 2015

Water Support Operations

Contents

	Page
PREFACE	iv
INTRODUCTION	v
Chapter 1 WATER OPERATIONS OVERVIEW	1-1
Water Support Operations.....	1-1
Fundamentals Of Water Treatment.....	1-1
Fundamentals Of Water Supply	1-1
Water Storage	1-2
Water Distribution and Issue	1-2
Army Water Organizations And Staffs.....	1-2
Strategic Partners.....	1-2
Operational Headquarters At Echelons Above Brigade	1-4
Sustainment Headquarters At Echelons Above Brigade.....	1-5
Brigade Level Water Operations	1-7
Marine Corps Water Organizations and Staffs.....	1-8
Chapter 2 WATER SUPPORT PLANNING	2-1
Water Planning Tools	2-1
Consumption Requirements.....	2-2
Water Force Structure Planning	2-4
Water Reconnaissance	2-4
Deployment and Redeployment Planning	2-9
Marine Water Planning.....	2-11
Chapter 3 DEVELOPMENT OF A WATER SITE	3-1
Water Site Development.....	3-1
Water Source Improvement.....	3-3
Chapter 4 WATER TREATMENT OPERATIONS	4-1

Distribution Restriction: Approved for public release; distribution is unlimited.

***This publication supersedes FM 10-52 dated 11 July 1990, FM 10-52-1 dated 18 June 1991, and FM 10-115 dated 15 February 1989.**

	Section I – Water Quality	4-1
	Water Quality Overview	4-1
	Field Water Quality Standards	4-2
	Diseases and Disinfection.....	4-6
	Water Treatment Processes	4-8
	Section II – Operator Water Treatment Planning	4-17
	Petroleum Requirements	4-17
	Chemical Requirements.....	4-18
	Water Treatment Reports	4-18
	Extreme Weather Considerations	4-18
	Chemical Biological Radiological Nuclear (CBRN) Capability	4-18
	Water Treatment Safety	4-19
	Environmental Stewardship Measures	4-19
	Section III – Water Treatment Systems	4-19
	125 Gallons Per Hour (GPH) Lightweight Water Purifier (LWP)	4-20
	1,500 GPH Tactical Water Purification System (TWPS)	4-21
	3,000 GPH Reverse Osmosis Water Purification Unit (ROWPU)	4-22
	Marine Corps Water Treatment Systems.....	4-23
Chapter 5	WATER STORAGE, DISTRIBUTION, AND ISSUE OPERATIONS	5-1
	Water Storage Operations	5-1
	Hypo-Chlorination Requirements.....	5-1
	Bulk Water Storage Systems	5-2
	Water Distribution Operations.....	5-4
	Water Distribution Systems.....	5-4
	Marine Corps Water Storage and Distribution Systems	5-7
	Water Issue	5-9
	Safety and Environmental Stewardship	5-9
Appendix A	WATER PLANNING FACTOR TABLES	A-1
Appendix B	DEPLOYMENT PLANNING CONSIDERATIONS	B-1
Appendix C	COMPUTATIONS FOR WATER SUPPORT OPERATIONS	C-1
	GLOSSARY	Glossary-1
	REFERENCES	References-1
	INDEX	Index-1

Figures

Figure 2-1. Notional water site	2-7
Figure 3-1. Turnout	3-2
Figure 3-2. Turnaround	3-3
Figure 3-3. Stake method.....	3-4
Figure 3-4. Gravel pit method	3-5
Figure 3-5. Gravel pit method with bucket	3-5
Figure 3-6. Improvised dam	3-6

Figure 3-7. Baffle dam 3-6

Figure 3-8. Ocean Intake Structure System (OISS) vertical and horizontal configuration..... 3-11

Figure 4-1. Water treatment flow chart..... 4-8

Figure 4-2. Reverse osmosis process..... 4-10

Figure 4-3. Reverse osmosis membrane composition 4-11

Figure 4-4. Spirally wound reverse osmosis membrane assembly..... 4-11

Figure 4-5. Breakpoint chlorination chart 4-17

Figure 4-6. Lightweight Water Purifier (LWP)..... 4-20

Figure 4-7. Tactical Water Purification System (TWPS) 4-21

Figure 4-8. Reverse Osmosis Water Purification Unit (ROWPU) 4-22

Figure 4-9. Lightweight Water Purification System (LWPS)..... 4-24

Figure 4-10. Marine Corps Tactical Water Purification System (TWPS)..... 4-25

Figure 5-1. 40,000 Gallon Water Storage and Distribution System (WSDS)..... 5-2

Figure 5-2. 300,000 Gallon Water Storage and Distribution System (WSDS)..... 5-3

Figure 5-3. Tactical Water Distribution System (TWDS)..... 5-5

Figure 5-4. Forward Area Water Point Supply System (FAWPSS)..... 5-5

Figure 5-5. 2,000 Gallon Load Handling System (LHS) Compatible Water Tank Rack System (HIPPO)..... 5-6

Figure 5-6. Unit Water Pod System (Camel II)..... 5-6

Figure 5-7. Water Buffalo 5-7

Figure 5-8. Six Container (SIXCON) Water Storage Module 5-8

Figure 5-9. Six Container (SIXCON) Water Pump Module 5-8

Tables

Table 2-1. Raw water source reconnaissance considerations 2-8

Table 2-2. Preventive medicine inspections 2-10

Table 2-3. Marine Corps water production and storage 2-11

Table A-1. Standard planning factors related to personnel in force (gal/person/day), conventional theater.....A-2

Table A-2. Standard planning factors related to personnel in force (gal/person/day), integrated theaterA-2

Table B-1. Deployment planning considerations.....B-1

Table C-1. Water support formulas C-1

Table C-2. Strength of chlorine solutions C-1

Table C-3. Chlorine dosage calculator C-2

Preface

ATP 4-44/ MCRP 3-17.7Q provides doctrinal guidance and direction for United States Army and United States Marine Corps units conducting water support operations. The techniques provided in this publication are non-prescriptive ways or methods that can be used to perform water support missions, functions, or tasks.

The principal audience for ATP 4-44/MCRP 3-17.7Q is all members of the profession of arms. Commanders and staffs of Army and Marine Corps headquarters serving as joint task force or multinational headquarters should also refer to applicable joint or multinational doctrine concerning the range of military operations and joint or multinational forces. Trainers and educators throughout the Army and Marine Corps will also use this publication.

Commanders, staffs, and subordinates ensure that their decisions and actions comply with applicable United States, international, and in some cases host-nation laws and regulations. Commanders at all levels ensure that their Soldiers and Marines operate in accordance with the law of war and the rules of engagement. (See FM 27-10/MCRP 5-12.1A).

ATP 4-44/MCRP 3-17.7Q implements STANAG 2136 and STANAG 2885.

ATP 4-44/MCRP 3-17.7Q uses joint terms where applicable. Selected joint and Army terms and definitions appear in both the glossary and the text. Terms for which ATP 4-44/MCRP 3-17.7Q is the proponent publication (the authority) are italicized in the text and marked with an asterisk (*) in the glossary. Terms and definitions for which ATP 4-44/MCRP 3-17.7Q is the proponent publication are boldfaced in the text. For other definitions shown in the text, the term is italicized and the number of the proponent publication follows the definition.

ATP 4-44/MCRP 3-17.7Q applies to the Active Army, Army National Guard/Army National Guard of the United States, United States Army Reserve, and the total force Marine Corps unless otherwise stated.

The proponent of ATP 4-44/MCRP 3-17.7Q is the United States Army Combined Arms Support Command. The preparing agency is the G-3 Doctrine Division, USACASCOM. Send comments and recommendations on DA Form 2028 (Recommended Changes to Publications and Blank Forms) to Commander, United States Army Combined Arms Support Command and Fort Lee, ATTN: ATCL-TDD (ATP 4-44), 2221 A Avenue, Fort Lee, Virginia 23801 or submit an electronic DA Form 2028 by e-mail to: usarmy.lee.tradoc.mbx.lee-cascom-doctrine@mail.mil. In addition to submission of DA Form 2028, provide same comments and recommendations in MilWiki for rapid dissemination to doctrine authors and for universal review at <https://www.milsuite.mil>.

Marine Corps personnel should submit suggestions and changes by e-mail to doctrine@usmc.mil or by mail to Deputy Commandant for Combat Development and Integration, ATTN: C116, 3300 Russell Road, Suite 204, Quantico, VA 22134-5021.

Introduction

ATP 4-44/MCRP 3-17.7Q is the United States Army and United States Marine Corps manual for planning and executing water support for missions conducted across the full range of military operations. In the U.S. Army, water support operations are a Quartermaster Corps function, as well as a component of Army Logistics. Army Logistics is an element of the sustainment warfighting function, which provides the operational commander freedom of action, extended operational reach, and operational endurance. Water support operations include water treatment, storage and distribution. Water treatment is a field service function, while water storage and distribution are supply functions. In the U.S. Marine Corps, water support operations are a general engineering function, as well as a component of tactical-level logistics. Logistics is a warfighting function in the Marine Corps. Water support operations are critical to the U.S. Army and U.S. Marine Corps; they directly impact the depth and duration of military operations.

ATP 4-44/MCRP 3-17.7Q will combine, restructure, and update information previously published in three field manuals:

- FM 10-52, *Water Supply in Theaters of Operations*, dated 11 July 1990.
- FM 10-52-1, *Water Supply Point Equipment and Operations*, dated 18 June 1991.
- FM 10-115, *Quartermaster Water Units*, dated 15 February 1989.

ATP 4-44/MCRP 3-17.7Q contains numerous revisions. The title has been changed to Water Support Operations to correctly incorporate terminology from FM 4-40, *Quartermaster Operations* and JP 4-03, *Joint Bulk Petroleum and Water Doctrine*. This publication incorporates current terminology from the Army's operational concept described in ADRP 3-0, *Unified Land Operations*. Additional current terminology is also included from FM 4-40, *Quartermaster Operations*, Technical Bulletin Medical 577, *Sanitary Control And Surveillance of Field Water Supplies*, JP 4-03, *Joint Bulk Petroleum and Water Doctrine*, STANAG 2136, *Requirements for Water Potability during Field Operations and in Emergency Situations*, and STANAG 2885, *Emergency Supply of Water in Operations*.

Information that has been revised from previous publications includes force structure changes, new equipment fielding, and improved planning techniques. Information that has been added to this publication includes strategic partners, web-based planning tools, environmental stewardship, and location of joint well-digging capabilities.

ATP 4-44/MCRP 3-17.7Q contains five chapters:

Chapter 1 provides an overview of water support operations, to include water treatment, storage, distribution, and issue. In addition, this chapter will familiarize the reader with water organizations and staffs in the United States Army and United States Marine Corps.

Chapter 2 discusses planning for water support operations. Water consumption requirements, water reconnaissance, and deployment preparation are explained in detail. Water planning tools are provided up front to assist staff members and water support personnel in planning operations. Environmental and health considerations are also discussed.

Chapter 3 provides considerations for developing a water site to improve efficiency. This chapter will also include techniques for improving a water source to meet raw water requirements.

Chapter 4 discusses water treatment operations, to include water quality, water treatment process, operator level planning, equipment, reports, and safety. In addition, this chapter will discuss extreme weather and environmental considerations.

Chapter 5 discusses water storage, distribution, and issue operations. This chapter will include information on hypo-chlorination standards, as well as respective equipment and reports.

This page intentionally left blank.

Chapter 1

Water Operations Overview

A general overview of water support operations is described in this chapter. Water support operations includes water treatment, storage, distribution, and issue. A detailed discussion of water organizations and staffs will identify water support responsibilities at strategic, operational, and tactical echelons of command.

WATER SUPPORT OPERATIONS

1-1. Water is one of the most important logistics commodities required to sustain military operations. Water is necessary for hydration, food preparation, medical treatment, hygiene, construction, decontamination, maintenance, and many additional tasks (continued in chapter two). Water support operations consist of treatment, storage, distribution and issue of *potable* and *non-potable water* in a theater of operations.

1-2. Water is classified by FM 4-40, *Quartermaster Operations*, as both a field service and a supply function. Water treatment is a field service. A field service provides adequate quality of life for Soldiers and Marines in a field environment. Water purification, quality surveillance, storage and distribution of both potable and non-potable water are supply functions. Water supply functions enable freedom of action, extend operational reach, and prolong operational endurance.

FUNDAMENTALS OF WATER TREATMENT

1-3. The water treatment process ultimately turns *raw water* into water that is matched to its end use. Raw water is found naturally and has not been treated. Raw water can be classified as fresh, brackish, or salt water (seawater) based on the concentration of total dissolved solids (TDS). Army and Marine Corps water treatment units can purify water from all three forms of raw water utilizing water treatment systems.

1-4. Raw water is sourced from surface or ground water. Surface water includes streams, rivers, ponds, lakes, seas, and oceans. Ground water includes springs and wells. Raw water, whether sourced from surface or ground water, gathers many impurities as it goes through the hydrologic cycle (discussed in chapter four). These impurities must be removed or reduced (depending on type of impurity) to levels acceptable for human consumption.

1-5. Water treatment systems are synonymous to water purification systems when discussed in this Army techniques publication. Water treatment systems remove suspended solids, microbiological contaminants and undesirable chemicals from raw water. Water treatment involves purifying water from a raw source, and chemically disinfecting (treating) purified water to achieve potability standards. Purifying water alone does not achieve potability. Purified water must be chemically disinfecting (treated) to achieve potability standards.

FUNDAMENTALS OF WATER SUPPLY

1-6. After water has been treated to achieve potable water standards, it is stored and distributed to Army and Marine Corps units based on consumption requirements. Water storage and distribution can occur at multiple *echelons* above and at the brigade level. Water is supplied to units as a bulk or packaged product. It is important for sustainment organizations and staffs to understand the supply chain implications for both products.

BULK WATER

1-7. This Army techniques publication will primarily focus on bulk water support. Bulk water is large in volume and must be distributed in tanks, bags, drums, hoses, or pipelines. Bulk water is produced as close

as possible to end users to minimize water distribution requirements. When equipment availability is limited, requirements for both potable and non-potable water can be met with potable water in order to prevent having two separate bulk water systems. Using potable water for non-potable purposes decreases opportunities for water reuse and the need to increase energy efficiency in theater. Using potable for non-potable purposes increases operational risk because it maintains an artificial demand for potable water that does not exist, and uses additional fuel that has to be procured and delivered. Planners need to incorporate risk of only having potable water for use in non-potable end uses.

PACKAGED WATER

1-8. Packaged water is sealed in individual containers such as plastic bottles or pouches. The most common form of packaged water is bottled potable water. Bottled potable water can be manufactured by military or commercial means. The Army has a small quantity of expeditionary water packaging systems in operational project stocks to meet initial combatant command requirements, and additional systems can be procured. These systems are normally maintained and operated by contractors under Army Materiel Command (AMC). Expeditionary water packaging systems are capable of bottling water, but still require a separate water treatment system (or bulk delivery) to receive potable water. Because packaged water is typically sourced from an industrial base through Department of Defense (DOD) contracts, it moves through multiple echelons prior to reaching the end user. Packaged water requires an extensive distribution network, which consumes transportation assets and materials handling equipment located at strategic, operational, and tactical echelons.

WATER STORAGE

1-9. Water units store potable bulk water to build required quantities in support of tactical operations. Stored bulk water is chlorinated to kill any residual harmful organisms and to assist in the retention of potability standards as it move through the distribution network. The final stage of water treatment includes injecting chlorine at two parts per million (ppm) to disinfect. Potable bulk water is issued from storage systems directly to end users, or issued for distribution to end users.

WATER DISTRIBUTION AND ISSUE

1-10. Bulk water distribution occurs at all echelons from Army Service component command (ASCC) to company level. Water units are designed to provide unit distribution to a brigade or battalion supply point. However, a combination of unit distribution, supply point distribution, and throughput distribution may be required at various echelons to meet water consumption requirements. *Unit distribution* is a method of distributing supplies by which the receiving unit is issued supplies in its own area, with transportation furnished by the issuing agency. *Supply point* distribution is a method of distributing supplies to the receiving unit at a supply point, railhead, or truckhead. When executing supply point distribution, receiving units travel to a supply point where they are issued water directly into their organic water distribution systems. *Throughput distribution* is a method of distribution which bypasses one or more intermediate supply echelons in the supply system to avoid multiple handling.

ARMY WATER ORGANIZATIONS AND STAFFS

1-11. Organizations and staffs at the strategic, operational, and tactical level enable water support operations. An understanding of the various roles and responsibilities at each echelon will help water planners and executers gain a comprehensive understanding of the water supply chain. Organic unit capabilities discussed in this section may increase or decrease based on force design and other operational variables. Chapter two includes web based planning tools that provide current unit capabilities.

STRATEGIC PARTNERS

1-12. It is critical that logistics leaders and commodity managers understand the strategic partners that play a role in water support operations. Each partner, the type of support provided, and coordination points of contact must be understood and leveraged.

ARMY

1-13. The Army is the DOD *executive agent* for management of land-based water resources in support of contingency operations per DOD Directive 4705.01E, paragraph 1.2. As prescribed in AR 700-136, *Tactical Land Based Water Resources Management*, the Deputy Chief of Staff, G-4 is designated the Army Staff proponent for land-based water resource matters in support of contingency operations and is delegated the authority to act on behalf of the Secretary of the Army for any or all of the DOD executive agent responsibilities, functions, and authorities. Based on executive agent responsibilities, Army organizations and staffs have a responsibility to account for all joint partners when determining water supply requirements.

ARMY GEOSPATIAL CENTER (AGC)

1-14. The AGC is a major subordinate command under the Army Corps of Engineers. AGC coordinates, integrates, and synchronizes geospatial information requirements and standards across the Army and provides direct geospatial support and products to Soldiers. When it comes to water resources, AGC's expertise encompasses the collection, analysis, synchronization, and provisioning of operational, strategic and tactical level water resource geospatial information for water resource reasoning and management; focusing on ground, surface, and man-made water resources features and facilities for the DOD. The AGC hydrologic analysis team maintains the water resource database, an enterprise geodatabase that provides information on quality, quantity, and availability of water resources focused on outside the United States areas of importance to the DOD. The data within the water resource database is attributed and categorized based on DOD water supply standards and equipment requirements. The AGC Water Detection Response Team (WDRT) is the DOD's prime organization for assisting military well drillers. Its primary function is to assist and advise well-drilling teams on the location of the best well-drilling sites and depths, and to provide information on drilling conditions for logistical planners.

ARMY MEDICAL DEPARTMENT

1-15. The Army Medical Department oversees Army medicine, which influences health to improve readiness in support of the total force. It is strategically aligned to provide force health protection during all contingency operations. Force health protection encompasses preventive medicine. Preventive medicine provides water quality surveillance and ensures the health of all Soldiers through their expertise in disease prevention. Preventive medicine ensures water quality is within standards set by the Army Medical Department.

DEFENSE LOGISTICS AGENCY (DLA)

1-16. DLA is the DOD strategic logistics provider and provides support for supply classes I, II, III, IV, VI, VII, and IX. DLA supports each geographic combatant command with a DLA support team that coordinates DLA activities throughout a theater of operations. DLA procures all water treatment chemicals, some water treatment system components, and some water treatment system replacement parts from commercial businesses that make up DOD's industrial base. DLA procures the majority of low cost and consumable items for water treatment systems, while Tank-automotive and Armaments Life Cycle Management Command (TACOM LCMC), a subordinate of Army Materiel Command, procures high cost and non-expendable items such as pumps, bags, and test kits (TACOM LCMC is discussed in more detail in paragraph 1-19). DLA typically does not store items in inventory, but rather utilizes established contracts to ship from vendor to customer. In some circumstances DLA may develop vendor contracts for packaged water support to Army and Marine Corps units.

ASSISTANT SECRETARY OF THE ARMY FOR ACQUISITION, LOGISTICS, AND TECHNOLOGY

1-17. The Assistant Secretary of the Army for Acquisition, Logistics, and Technology oversees the program executive office which supervises the product manager (PM) for water systems for the Army. The PM for water systems works with original equipment manufacturers to design and develop new material solutions that fill water capability gaps. The PM also works with original equipment manufacturers to develop associated new equipment manuals (such as technical manuals) and new equipment training programs. The PM fields or deploys new water systems to Army units and Army stocks based on authorizations and operational requirements. The PM also oversees water systems life cycle management, which is executed by

the Integrated Logistics Support Center (ILSC), a subordinate to TACOM LCMC. Although the PM does not belong to AMC or TACOM LCMC, the PM must work closely with these organizations to ensure quality life cycle logistics support and water systems management.

ASSISTANT SECRETARY OF THE ARMY FOR INSTALLATIONS, ENERGY, AND ENVIRONMENT

1-18. The Assistant Secretary of the Army for Installations, Energy and Environment oversees contingency base policy, including their design, construction, and operations, and maintenance. The contingency base must be designed and be operated in order to accommodate the water needs of the resident population. This includes both potable and non-potable water storage locations and accessibility.

AMC (ARMY MATERIEL COMMAND), TACOM LCMC (TANK-AUTOMOTIVE AND ARMAMENTS LIFE CYCLE MANAGEMENT COMMAND), AND ILSC (INTEGRATED LOGISTICS SUPPORT CENTER)

1-19. AMC is the Army's lead materiel integrator and provides technology, acquisition support, materiel development, logistics power projection, and sustainment support. AMC is the headquarters for TACOM LCMC, which executes life cycle management through the ILSC. The ILSC has item managers that procure water systems, high value replacement parts, and non-expendable components from commercial businesses that make up DOD's industrial base. LCMC typically stores these high value items in inventory (unlike DLA). The item managers field or deploy water systems to Army units and Army stocks based on authorizations and operational requirements.

OPERATIONAL HEADQUARTERS AT ECHELONS ABOVE BRIGADE

1-20. The operational headquarters above brigade will typically consist of an ASCC, a joint task force (JTF) formed by an Army corps, and a division headquarters. As the headquarters organizations providing mission command to various subordinate commands within the force, they must be fully aware of water requirements and statuses of subordinate organizations. These headquarters must integrate water support into all planning and effectively communicate, coordinate, and cooperate with the various sustainment headquarters and support organizations. These headquarters are key to establishing water requirements and forecasting future demand. An additional capability that resides in the Army National Guard is water reconnaissance and well-drilling teams within the engineer corps. See chapter two for further details.

ARMY SERVICE COMPONENT COMMAND (ASCC)

1-21. The ASCC is the senior Army command in an area of responsibility (AOR) responsible for all sustainment support requirements established under Title 10 United States Code. The ASCC can be tailored and augmented to the specific requirements of the AOR it supports while providing a long term presence supporting Army forces in unified land operations, and to joint forces in the joint operations area. Responsibilities of the ASCC include communicating capabilities to the geographic combatant commander, coordinating with the industrial base, overseeing common user logistics, conducting Army executive agent responsibilities, coordination with joint or multi-national partner theater-level components, supporting multiple joint operations areas, and to conduct theater level planning.

1-22. Embedded within the ASCC are staff elements which play a vital role providing staff oversight of water supply, storage, reporting, and health safety within the AOR. The assistant chief of staff, operations (G-3) and the assistant chief of staff, logistics (G-4) are the primary staff at the ASCC level concerned with water requirements determination. Theater level water situational awareness occurs between the ASCC and the theater level logistics headquarters.

JOINT TASK FORCE (JTF) AND CORPS

1-23. The Army corps headquarters is the organization best suited for commanding and controlling land forces or transitioning to a JTF or joint force land component commander headquarters for major operations. A division headquarters is also capable of transitioning to a JTF or joint force land component commander.

The staff structure of a corps and division headquarters are similar and responsibilities are relatively the same. The operations directorate of a joint staff (J-3) and logistics directorate of a joint staff (J-4) work together to establish logistics priorities for the joint operations area. The logistics directorate of a joint staff (J-4), with input from the manpower and personnel directorate of a joint staff (J-1) and operations directorate of a joint staff (J-3), will plan and forecast water requirements to support tactical operations. The logistics directorate of a joint staff (J-4) consolidates reports, monitors statuses, and communicates requirements through support channels.

DIVISION HEADQUARTERS

1-24. The division headquarters, the echelon of command below corps, is capable of performing mission command of multiple brigade combat teams (BCTs) and other functional and multifunctional brigades engaged in unified land operations. The BCTs may be of a habitual or historical mission command relationship or they may be task organized and assigned, as needed, for particular missions. The division assistant chief of staff, operations and G-4 have responsibilities to plan for water requirements in support of operations, as well as receive, consolidate, monitor, and communicate water reports through support channels during operations. However, the actual function of providing logistical support to facilitate water supply operations on the battlefield rests with sustainment organizations. Water materiel management functions are performed at the theater sustainment command (TSC), expeditionary sustainment command (ESC), and sustainment brigade headquarters.

SUSTAINMENT HEADQUARTERS AT ECHELONS ABOVE BRIGADE

1-25. Sustainment headquarters allocate resources in order to meet operational requirements and priorities for water support. It is imperative that the operational and sustainment headquarters maintain close coordination and cooperation with each other to ensure complete understanding of the operational environment, support priorities, and water support capabilities.

THEATER SUSTAINMENT COMMAND (TSC) AND EXPEDITIONARY SUSTAINMENT COMMAND (ESC)

1-26. The TSC is the senior Army sustainment headquarters within an AOR. The TSC is assigned to and receives mission command from the ASCC in support of the geographic combatant commander. It provides centralized mission command and enables decentralized sustainment operations throughout an AOR. The TSC provides the sustainment needed by Army forces to extend operational reach, enable freedom of action, and prolong endurance. The TSC is focused on strategic and operational sustainment management, acting as a bridge between the strategic and operational levels of logistics by coordinating with national providers, and directing subordinate logistics commands in the AOR.

1-27. The TSC has four operational responsibilities to forces in theater: theater opening, distribution, sustainment, and theater closing. The TSC provides water support by directly managing the requirements, storage objectives and distribution of water in the assigned AOR. The TSC ensures an adequate water support structure is in place to support the AOR. The fuel and water branch within the TSC support operations (SPO) staff section plan and coordinate water support with subordinate ESCs or other subordinate headquarters as necessary. The TSC also reaches back to leverage strategic partners as necessary.

1-28. The role of the ESC is to deploy to an area of operations and provide mission command capabilities when multiple sustainment brigades are employed or when the TSC determines that a forward command is required. The ESC may be employed directly under the mission command of the corps, Army forces, or JTF as designated by an appropriate order. The TSC maintains oversight of sustainment operations within an area of operations through direct coordination with the ESC and its sustainment information systems. This capability provides the TSC commander with the regional focus necessary to provide effective operational-level support to Army or JTF missions. The TSC may employ multiple ESCs within the theater.

1-29. The forward deployment of the ESC facilitates agile and responsive support by placing the ESC in relative proximity of the supported force. Positioned to provide a regional focus, the ESC is optimally placed

to refine that portion of the TSC logistics preparation of the theater assessment applicable to the JTF area of operations and to array logistics forces accordingly. While the organizational design of the TSC and ESC are similar, the ESC is focused on synchronizing operational-level sustainment operations to meet the day-to-day and projected operational requirements of the JTF or supported force. Similar to the TSC, the fuel and water branch within the ESC support operations (SPO) staff section plan and coordinate water support with subordinate sustainment brigades or other subordinate headquarters as necessary.

SUSTAINMENT BRIGADE AND COMBAT SUSTAINMENT AND SUPPORT BATTALION (CSSB)

1-30. Sustainment brigades provide mission command to units to execute the missions directed by the TSC and ESC. The sustainment brigade is a flexible, tailorable organization that performs theater opening, distribution, and sustainment missions, often simultaneously, and is capable of supporting joint and multinational operations. Each sustainment brigade is a multifunctional organization, tailored and task organized to provide support for multiple brigade-sized or smaller units using its subordinate battalions, companies, platoons, and teams to perform specific sustainment functions. The sustainment brigade provides mission command of all assigned, attached, and operational control (OPCON) units. The fuel and water section within the SPO staff section provides water planning, guidance, and support to forces in an area of operation.

1-31. CSSBs are modular, tailorable, task organized building-block organizations that perform functional missions in support of sustainment brigade missions. The CSSB is attached to the sustainment brigade and provides general support to BCTs, multifunctional support brigades, and other units operating in its assigned support area. The SPO staff section provides water planning, guidance, and support to forces in an assigned support area. A CSSB can typically provide mission command for up to seven attached companies. A water support company or a composite supply company will be attached to or placed operational control (OPCON) to the CSSB to execute water support operations. BCTs are dependent on the CSSB to provide purified water, as they do not have organic water treatment systems.

QUARTERMASTER WATER SUPPORT COMPANY

1-32. The mission of a quartermaster water support company is to produce, store and distribute potable water to supported units within a designated area. The company has three platoons, each capable of producing potable water (maximum of 150,000 gallons per day from *fresh water* source and 100,000 gallons per day from a brackish or contaminated source) with organic water treatment systems (two reverse osmosis water purification units [ROWPUs] and one tactical water purification system [TWPS] per platoon). Each platoon can store potable water (maximum of 40,000 gallons with two 20,000 gallon bags or 100,000 gallons with two 50,000 gallon bags) with organic water storage systems. The organic distribution capability for each platoon is 20,000 gallons per day (or 40,000 gallons with two turns). Water support companies are designed to expand capabilities by drawing water storage and distribution systems (WSDS) from Army Prepositioned Stock. Types of WSDS are discussed in chapter five, Water Storage, Distribution and Issue. In addition to the three platoons, this company may also have mission command of a Tactical Water Distribution System (TWDS) detachment (also known as a hoseline detachment). This unit provides additional potable water distribution by establishing, maintaining, and operating up to 10 miles of hose line. The majority water support companies are located in the Army National Guard and Army Reserve. This company will normally be attached to a CSSB and have a general support relationship with supported units.

COMPOSITE SUPPLY COMPANY (CSC)

1-33. The mission of a composite supply company is to provide general supply, petroleum, and water support to the BCT and supported units. The composite supply company has a supply support activity platoon, a fuel platoon, and a water platoon; a second version of the composite supply company may also have an ammunition transfer and holding point section. The water platoon is capable of producing potable water (maximum of 130,000 gallons per day from fresh water source and 86,000 gallons per day from a brackish or contaminated source) with organic water treatment systems (four TWPS and four lightweight water purifiers [LWPs]). The organic storage capability of this platoon is 80,000 gallons, and the organic distribution capability is 60,000 gallons per day (or 120,000 gallons with two turns). The water section primarily stores and distributes water using WSDSs and 2,000 gallon load handling system (LHS) compatible

water tank rack systems (HIPPOs). A composite supply company may increase capabilities by drawing systems from Army Prepositioned Stock. This company will normally be attached to a CSSB and have a general support relationship with supported units.

BRIGADE LEVEL WATER OPERATIONS

1-34. BCTs are the primary combined arms force that executes unified land operations for the Army. There are three standard types of BCTs: the armored brigade combat team, the infantry brigade combat team, and the Stryker brigade combat team. BCTs primarily receive logistics support (including water support) from an organic brigade support battalion (BSB).

BRIGADE S-4

1-35. The brigade S-4 develops, coordinates, and monitors plans, policies, procedures, and programs for supply, transportation, maintenance, field services, and facilities for the command's subordinate units. It determines logistics requirements for subordinate units, monitors the logistics posture of subordinate units, and establishes support priorities in accordance with the commander's priorities and intent. Requirements are determined in coordination with the brigade S-1 and brigade S-3. This staff section provides staff supervision of subordinate unit field feeding and subsistence operations; monitors and analyzes subordinate unit equipment readiness status. It is also responsible for planning and management of fixed facilities and coordination of construction, utilities, and real estate for the command.

BRIGADE SUPPORT BATTALION (BSB)

1-36. The BSB's role is to support the brigade's execution of operations by providing logistic support. The BSB commander must understand the supported commander's plan and then execute support so the brigade maintains freedom of action and maneuver. Tactical logistics and Army Health System support must be integrated into the brigade's concept of operations.

1-37. The BSB commander exercises mission command over all organic BSB capabilities in support of BCT priorities. The forward support companies (FSCs) extend the operational reach of the BSB into the maneuver area and are critical to the success of the logistic concept of support. BSBs perform similar roles in support of brigades, however, the capabilities of a BSB vary by design. The BSB provides area support on an exception basis when they have the capability and capacity to do so.

BSB SUPPORT OPERATIONS (SPO)

1-38. The BSB SPO is the principal staff officer responsible for synchronizing BSB water distribution operations for all units assigned or attached to the brigade. The BSB SPO is responsible for applying the BSB capabilities against the brigade's requirements. The brigade S-4 identifies requirements through daily logistic status reports, running estimates, and mission analysis.

1-39. The brigade S-4 is the log planner for the brigade, focusing on long range planning. The brigade S-4 develops the brigade concept of support. The SPO straddles mid-range and short range planning. The SPO develops the concept of operations (based on the concept of support) and the distribution or logistics package plan. A logistics package is a grouping of multiple classes of supply and supply vehicles under the control of a single convoy commander. The BSB SPO is the key interface between supported units and the sustainment brigade. The SPO is responsible for coordinating water support requirements with CSSB and sustainment brigade SPOs.

BSB DISTRIBUTION COMPANY AND FORWARD SUPPORT COMPANY (FSC)

1-40. The fuel and water platoon (located in the distribution company of the BSB) provides water storage and distribution support to the BCT. The water section within the fuel and water platoon does not have an organic water treatment capability. The water section is reliant on the composite supply company to provide water treatment capabilities, which may be pushed forward based on the concept of support. The distribution company water section has the capability to store and distribute water utilizing a forward area water point supply system (FAWSS) and water HIPPOs (23,000 gallons with ten HIPPOs and one FAWSS). Of note,

aviation support battalions do have an organic water treatment capability to support internal combat aviation brigade potable water requirements.

1-41. FSCs do not have the organic capability to purify water, or store and distribute water to maneuver units. Water equipment organic to FSCs are the 400 gallon M-149 “water buffalo” and the 800 gallon unit water pod system “camel II,” which supports the FSC field feeding mission and internal FSC water consumption. The BSB may provide water HIPPOs to the FSC battalion supply point, in which maneuver companies would receive water through unit distribution.

MARINE CORPS WATER ORGANIZATIONS AND STAFFS

1-42. The Marine Corps has several different tactical organizations that are capable of providing water support and hygiene services to meet the requirements of Marine air ground task forces (MAGTFs) that are conducting missions across the full range of military operations. MAGTFs include four elements; logistics combat element, aviation combat element, command element and ground combat element. Water support organizations within each Marine expeditionary force (MEF) sized MAGTF include the engineer support battalion (ESB) and the combat logistics battalions (CLBs) of the Marine logistics group (MLG), and the Marine wing support squadrons (MWSSs) in the Marine aircraft wing. The MLG CLB and the MWSS are typically designated to provide direct support to a regimental combat team (RCT) or Marine aircraft group (MAG) respectively. The ESB is employed to provide general support across a MEF or Marine expeditionary brigade (MEB) sized MAGTF. The Marine expeditionary unit (MEU) sized MAGTF possesses a single water section within the engineer platoon of the MEU CLB.

COMBAT LOGISTICS BATTALION (CLB)

1-43. An RCT typically consists of three infantry battalions that are reinforced with detachments provided by the combat support battalions of the Marine division (combat engineer, light armored reconnaissance, artillery, tank, assault amphibian, reconnaissance). An RCT receives direct logistic support from a designated CLB of the MLG. A habitual supporting unit to supported unit relationship exists between the RCT and the CLB in garrison and while deployed. Core competencies of a CLB include executing water support operations (purifying, storing and distributing potable water) and providing hygiene services to support ground maneuver units. The CLB is an agile unit with a limited capability and capacity to provide water support and hygiene services. The CLB possesses a small quantity of organic lightweight water purification systems (LWPS) to purify fresh, brackish or salt water. The CLB uses small collapsible storage tanks, water six container (SIXCON) systems, hoses, and connection sets to store bulk potable water. The water SIXCON system is described in chapter 5. The CLB can use SIXCONs and 400 gallon water tank trailers (water buffalos) to deliver bulk potable water to the supported ground units on the forward edge of the battlefield. Hygiene services are provided via a small quantity of portable field shower and laundry units which typically are positioned near a raw water source or centrally located in the RCT’s battlespace. The CLB does not possess the tactical water purification system (TWPS) due to the large ground footprint that is required to install and operate the TWPS. A water section is located in the engineer company of the MLG CLB. The section generally consists of less than a squad sized detachment of water support technicians (MOS 1171).

1-44. The MEU sized MAGTF possesses an organic CLB. The MEU CLB contains a water section that is located inside the battalion’s reinforced engineer platoon. This engineer platoon provides general support general engineering to the entire MEU. It is capable of producing bulk potable water and operating field showers by using its organic equipment (LWPS, collapsible storage tanks, hoses and field shower unit).

ENGINEER SUPPORT BATTALION (ESB)

1-45. The ESB provides general support general engineering to a MEF or MEB sized MAGTF. The ESB contains the requisite personnel, equipment and command and control mechanisms necessary to conduct simultaneous water support operations across the MAGTF’s battlespace. Its core competencies include executing water support operations and providing hygiene services. The battalion maintains a more robust water support capability and capacity than the CLBs of the Marine logistic group. Additionally, the ESB has a larger quantity of water purification equipment including the LWPS and the TWPS, which allow it to purify fresh, brackish or salt water. The battalion uses small (500 and 3,000 gallon) and large (20,000 and 50,000

gallon) collapsible storage tanks, water SIXCON systems, hoses and connection sets to store bulk potable water. Water distribution can be accomplished by using SIXCONs, 400 gallon water tank trailers, water pumps and scalable expeditionary water distribution systems (EWDS). Each EWDS has the capability to distribute water across a distance of 1.4 miles. The EWDS is discussed in chapter 5. Hygiene services are provided by a sizable quantity of portable field shower and laundry units that are typically located near a raw water source. These hygiene equipment items can be positioned to support company level or larger organizations throughout the MAGTF's battlespace. The engineer support company of the ESB contains a large utilities platoon that consists of water support technicians (MOS 1171).

MARINE WING SUPPORT SQUADRON (MWSS)

1-46. The MWSS is organized to provide aviation ground support directly to a composite MAG. It is capable of simultaneously operating one main air base and two forward arming and refueling points. The squadron's primary purpose is to sustain the operational tempo in terms of sortie generation for the supported MAG and attached elements of the Marine air control group. This can be accomplished from either a sea base (comprised of amphibious assault ships), shore based air installations (bare base or expeditionary airfield), or a combination of both. Core competencies of the MWSS include executing water support operations to address personal consumption, aviation maintenance, hygiene service, aircraft rescue and firefighting, and dust abatement requirements of the supported MAG. The MWSS possesses the LWPS and TWPS, which allow it to purify fresh, brackish and salt water. It also possesses collapsible storage tanks (3,000 and 20,000 gallon), SIXCONs, hoses and connection sets to store bulk potable water. To distribute bulk potable water, the MWSS can use SIXCONs, 400 gallon water tank trailers, water pumps and the EWDS. The MWSS provides hygiene services by using organic portable field shower and laundry units. The engineer company of the MWSS contains a squad of water support technicians (MOS 1171) in the water supply and hygiene branch.

This page intentionally left blank.

Chapter 2

Water Support Planning

This chapter begins with a discussion of water planning tools available to water staff planners and systems operators. Water requirements are based on many operational factors that are discussed below. A water reconnaissance is conducted to ensure the selected water site is most conducive to water support operations. Deployment planning considerations are provided to ensure water unit readiness.

WATER PLANNING TOOLS

2-1. Planners and executors at all echelons can benefit from knowledge of several water planning tools available through various DOD websites. These planning tools will assist in water source identification, water consumption requirements, and determining unit organic capabilities.

ARMY GEOSPATIAL CENTER (AGC)

2-2. The AGC website can assist in determining a raw water source. The AGC hydrologic analysis team maintains a water resource database that provides information on quality, quantity, and availability of water resources in areas of the world of interest to DOD. The water resource database is an improved, expanded and automated water resources intelligence database that can assist commanders in making water support logistics decisions. AGC's water resource layers are the primary data set populating the water resource database geographic information system, which depicts existing water facilities, surface water supplies, and ground water resources. Coverage is global in extent but focused on arid and semi-arid regions.

2-3. The AGC water detection response team is the DOD's prime organization for assisting military well drillers, whether for military or humanitarian, or nation-building activities. Its primary function is to assist and advise well-drilling teams on the location of the best well-drilling sites and depths, and to provide information on drilling conditions for logistical planners. A staff of ground water experts is available on-call to provide information and assistance, and to produce studies for military well-drilling-related activities. The team possesses an inventory of state-of-the-art remote sensing and geophysical equipment, and has numerous bibliographic sources readily available for most areas of the world. The water detection response team also offers a "Hydrogeology for Military Well Drillers" short course upon request.

POTABLE WATER PLANNING GUIDE

2-4. The Potable Water Planning Guide is available for download on the U.S. Army Quartermaster Petroleum and Water Department website. The planning factors take into account various environments, echelons, and activities. Planners should modify or adjust these standard planning factors based on the latest logistics preparation of the battlefield assessments or other unique conditions associated with a given operation or area of operations. Appendix A, Water Planning Factor Tables, details standard planning factors for general theater planning (these tables were obtained from the potable water planning guide).

OPLOG (OPERATIONAL LOGISTICS) WATER CONSUMPTION CALCULATOR

2-5. The Combined Arms Support Command planning data branch website contains an OPLOG planning tool used to determine water consumption requirements. The OPLOG planner is the Army's program of record for water planning. The water planning guide contains all feeder data pertaining to water planning factors that are used in automated systems, which includes the OPLOG planner.

FORCE MANAGEMENT SYSTEM WEBSITE AND ARMY EQUIPPING ENTERPRISE SYSTEM

2-6. The Army force management system website and the Army equipping enterprise system website are two resources that can be used to determine unit organic water support capabilities. The force management system website contains unit requirement and authorization documents for all Army units, which includes personnel and equipment. The Army equipping enterprise system contains current unit on hand capabilities for both personnel and equipment. These systems can assist staff planners in understanding the water support capabilities of modular sustainment units, as well as determining water support requirements for supported units.

CONSUMPTION REQUIREMENTS

2-7. Planning for water support begins with determining the amount and quality of water required. This will depend on mission guidance from the tactical commander, mission scope, mission duration, stage of operation, operational environment, enemy chemical, biological, radiological, and nuclear (CBRN) capabilities, and size of the force. The potable water planning guide provides commanders and logistics staff planners at all echelons with a comprehensive water sustainment planning tool. Information in the potable water planning guide will enable logistics planners to identify requirements, assess capabilities and identify water purification, storage and distribution requirements to support military force projection operations. There is no formal supply accountability for water. In regions with an extreme environment, the commander may issue water restriction guidance to conserve and prioritize water supplies. All levels of command must be concerned with the quantity and quality of water.

POTABLE WATER REQUIREMENTS

2-8. Potable water, as described in TB MED 577, *Sanitary Control and Surveillance of Field Water Supplies* is required for the following activities:

- Drinking.
- Ice making.
- Food preparation.
- Medical treatment.
- Personal hygiene (brushing teeth, shaving, and showering).
- Mortuary affairs operations.
- CBRN decontamination (refer to TB Med 577).

NON-POTABLE WATER REQUIREMENTS

2-9. Preventive medicine personnel may approve the use of non-potable water for certain activities. If non-potable water is used, it is preferable to use fresh water whenever possible. Brackish and saltwater are minimally acceptable and may lead to significant corrosion if used. Non-potable water, as outlined in TB MED 577, falls into different classes based on filtration and suitability for the following activities:

- Laundry (water must meet quality standards outlined in TB MED 577).
- Engineer construction.
- Aircraft maintenance (water must meet quality standards outlined in aircraft technical manual).
- Vehicle maintenance.
- Vehicle and cargo washing.
- CBRN decontamination (refer to TB MED 577).
- Firefighting.
- Pest control.
- Dust control.

MULTINATIONAL AGREEMENTS AND HOST NATION CONSIDERATIONS

2-10. North Atlantic Treaty Organization (NATO) countries have agreed when operating on land, to adopt minimum requirements for potability of drinking water to be issued to troops in combat zones or in any other emergency situations. The two agreements that encompass water quality standards are the NATO Standardization Agreement (STANAG) 2136, *Requirements for Water Potability During Field Operations and in Emergency Situations*, and NATO STANAG 2885, *Emergency Supply of Water in Operations*. As a member nation of NATO, the U.S. has agreed to accept and provide water meeting these standards when participating in multi-national water support operations. Of note, the quality standards outlined in TB MED 577 meet or exceed these requirements.

2-11. Multinational forces are responsible for their own water support systems. However, if they exceed their capabilities, the joint commander may direct the Army to provide backup water support.

ENVIRONMENTAL PLANNING FACTORS

2-12. The type of environment where operations take place will significantly impact water consumption planning factors. The four types of environments; tropical, arid, temperate, and arctic, each present different planning considerations. The planning factor tables in Annex A account for each type of environment.

Tropical

2-13. Tropical areas of the world have an annual mean daily temperature of more than 80 degrees fahrenheit. In tropical regions, water sources are expected to be abundant. Dense vegetation and lack of roads may pose significant problems in exploiting water sources. Poor ground lines of communication may inhibit water distribution by truck and place greater reliance on aerial resupply. Individual consumption will increase due to high temperatures and humidity. Cool water should be provided when feasible to encourage Soldiers and Marines to drink large quantities of water to prevent heat injuries.

Arid

2-14. Arid areas of the world have an annual daily temperature of more than 80 degrees fahrenheit. In arid regions, available water sources are limited and widely dispersed. The lack of water sources will result in a large storage and distribution requirement. Potable water is used to meet non-potable water requirements when raw water is unavailable. Individual consumption will increase due to high temperatures. Cool water should be provided when feasible to encourage Soldiers and Marines to drink large quantities of water to prevent heat injuries.

2-15. Planners should assume no host nation water is available in arid regions. Minimal water sources and poor water quality will limit any operation that depends on host nation support. In the early days of deployment, host nation processed or bottled water may be used if certified as potable by preventive medicine personnel. Use of host nation municipal or private fixed facilities is dependent on the above stipulations and local policies as directed by the theater commander.

Temperate

2-16. Temperate areas of the world have an annual mean daily temperature ranging from 32 degrees fahrenheit to 80 degrees fahrenheit. In temperate regions water sources are normally abundant. Sources convenient for water supply operations should be easy to locate and develop. Drinking water typically does not need to be cooled.

Arctic (Cold)

2-17. Arctic areas of the world have an annual mean daily temperature of less than 32 degrees fahrenheit. In arctic regions, dominant water sources are unfrozen water underlying frozen rivers and lakes, or civilian and military constructed wells. Location and exploitation of water sources convenient for water supply operations may be difficult. The dispersion of suitable water sources will result in a large distribution requirement. Water treatment, storage, and distribution systems may require augmentation with additional equipment to prevent freezing. Individual consumption should be greater than in temperate regions to prevent dehydration.

WATER FORCE STRUCTURE PLANNING

2-18. The proper force structuring of water support and the time-phased deployment of units in that structure is an iterative process. It is done by organizational integrators who consider the operational scenario, strategic lift availability (sorties), and pre-positioned supplies and equipment. The process normally begins with the identification of the force size and planned troop deployment rate. Time-phased water requirements are then estimated using consumption planning factors (Appendix A). Sustainment organization commanders and staffs must assess adequacy of water capabilities and request additional capabilities as required. Units are then selected and scheduled for deployment so that treatment, storage, and distribution capabilities are consistent with requirements.

2-19. Early deployment of water units can be expected in arid regions. This is necessary because of the increased consumption requirements, limited availability of aircraft for aerial resupply, and the need for centralized production. Centralized production will be near the shore or offshore; tank trucks for distribution will be required early on. The water units needed to operate high-capacity water treatment systems, as well as water supply companies and detachments that operate water storage and distribution systems, will deploy early during most operations.

2-20. Since the capability of Army units and other services to produce their own requirements may be difficult to predict, logistics planners must provide a force structure adequate to purify, store, and distribute the daily requirement for the force. Logistics planners should develop contingency plans with host nations for identifying and determining the availability of water resources for use by U.S. forces. Existing host nation communication channels should be used to determine the ability of the host nation to assist in meeting water requirements.

2-21. In emergency situations, or when personnel are cut off from supply lines, the use of iodine tablets can be used to minimize the risk for severe intestinal distress caused by water borne pathogens. See TB MED 577 for information on the use of iodine tablets, and additional information on emergency field water standards.

WATER RECONNAISSANCE

2-22. After water consumption requirements are projected, a water reconnaissance must be conducted prior to establishing a water site. The water reconnaissance team should consist of a water treatment specialist, as well as preventive medicine, engineer, and CBRN personnel. The water reconnaissance team must have a clear understanding of the operation plan, intelligence situation, operational environment, and concept of support plan prior to conducting a reconnaissance. Preventive medicine, engineer, and CBRN, personnel should augment the reconnaissance team to provide expertise in determining the viability of a water site. The water reconnaissance team will validate primary and alternate water sites during the reconnaissance.

WATER RECONNAISSANCE PLANNING

2-23. Proper planning is essential to water site selection and should be foremost in the minds of the reconnaissance personnel. The planning for a water site, whether it be for treatment, storage, or distribution, begins with mission guidance from the tactical commander. Whenever possible, include the water site within logistics areas (such as a Brigade Support Area) or base camp. At the very least, laundry, bath, and personnel decontamination units should be near water supply operations for mutual support. To enhance resupply operations, collocate Class I and water points. Unit intelligence personnel are the source for information concerning ground and air reconnaissance and surveillance, imagery, human intelligence, and other sources of terrain and technical intelligence.

RECONNAISSANCE OBJECTIVES

2-24. Water supply reconnaissance is concerned with the quantity and quality of water available, the extent to which the source has been developed, and the potential for establishment of a water site. The team must consider placement of water storage and distribution equipment within the water site. A satisfactory water source is one of sufficient quantity to meet the needs of the force it is supporting, and of such quality that it

can be purified to military water standards and sustainable on a long term basis. A reconnaissance team assesses the following areas related to water source and water site development:

- Type of water source.
- Amount of water available, including rate of replenishment.
- Quality of raw water.
- Survey two miles upstream for possible contamination.
- Route of water from original source to proposed extraction point.
- Feasibility of impounding water by construction of dams, embankments, or infiltration trenches (for springs, streams, and rivers).
- Available Space.
- Site layout requirements to ensure proper land use (consider treatment, storage, and distribution system requirements).
- Suitability of terrain.
 - Avoid sloped ground.
 - Avoid low areas where vapors can collect.
 - Seek firm ground, free of surface rocks and large stones.
 - Soil conditions for proper draining.
- Road networks.
- Hazards.
- Existing facilities available for use.
- Bivouac for personnel.
- Security, to include cover and concealment.

2-25. For detailed information on the above-mentioned areas, see chapter three, paragraph 3-1 to 3-10.

RECONNAISSANCE EQUIPMENT

2-26. During a water site reconnaissance, water treatment specialists will take the Water Quality Analysis Set-Purification (WQAS-P) equipped with the M272 Chemical Agents Water Testing Kit and the M329 Joint Chemical, Biological, Radiological Agent Water Monitor (JCBRAWM). During a water reconnaissance, water treatment specialist will analyze the raw water for turbidity, TDS, potential of hydrogen (pH), and temperature. The M272 Chemical Agents Water Testing Kit is for visual tests using color comparison to determine hazardous levels of Lewisite, Nerve, Cyanide, and Mustard agents. The M329 Joint Chemical, Biological, Radiological Agent Water Monitor (JCBRAWM) detects and presumptively identifies biological agents and detects and quantifies the presence of radiological *contamination* in water. It also provides field capability to detect two biological agents per handheld assay and gross alpha and beta radiological contamination.

RECONNAISSANCE OPERATIONS

2-27. Maps and aerial photographs should be studied prior to the actual air and ground reconnaissance. Because military maps may be incomplete and outdated, an air reconnaissance should precede a ground reconnaissance when time and equipment permit. An air reconnaissance is a rapid means of securing information about water sources and potential storage and distribution sites over a large area. An air reconnaissance is limited by adverse weather and security considerations.

2-28. A ground reconnaissance is the only way of obtaining accurate information to select a water site or storage and distribution area. First-hand knowledge of the terrain is critical to planning. Water treatment specialists are responsible for conducting a water quantity and quality analysis on site.

DA Form 1712

2-29. DA Form 1712 (Water Reconnaissance Report) is used to record information about the proposed water site during the site survey. Data entered on the DA Form 1712 must be accurate and detailed as logistics planners will be basing their decision on this information.

Section One

2-30. Section one includes the quality and quantity of a water source. This information facilitates the selection of the most suitable water source for operations based on the amount and quality of water available at a source. The type of source will influence site selection by indicating contamination potential and security requirements for operation on the source. TDS, Temperature, Turbidity, and pH will effect water production and chemical and material requirements for operation on the source. Quantity indicates the potential duration of operations on the site, as well as the production capability.

Section Two

2-31. The Site conditions section indicates the immediate condition of the operational site, as well as projections for suitability and additional improvements (completed organically or with engineer support) that are required or recommended.

- Security: Lists the general defensibility of the site and should contain a force protection assessment, to include cover and concealment, avenues of approach, egress options and a response time estimate for support or quick reaction force if available. Additionally, the security section should include an assessment for protecting the water source.
- Drainage-Soil Type: Lists the suitability of a site for continuous operation in regards to mud or standing water generation. This section is for recon personnel to indicate if the site has adequate drainage either as a result of topography or absorption potential of the soil, as well as to identify what site improvements would be required to create suitability.
- Terrain: Lists the general topography of the area, which ties closely to the security and drainage sections, as well as giving an indication of accessibility for customers or resupply. This section would also list any recommendations for water source development or road network improvements.
- Bivouac: Lists the life support potential for the area, both in potential capacity, and special requirements needed to sustain adequate living conditions for operators. Temperature and wildlife concerns would be listed here, and potential improvements that would be required to mitigate those issues, in addition to any associated risks with the drainage (soil type or terrain).
- Distance to Consumers: If known, this section allows planners at the staff and operator level to determine logistical requirements associated with operating on the projected site, and is an important discriminating factor when multiple site locations are available.

Sketch of Area

2-32. This section is used to create an overhead view of the operational site, including road nets and traffic circulation. The sketch should include the proposed site layout, with all equipment in place and distances between key areas included in the sketch. A scale must be included in order for planners to project additional needs for the operational area and determine suitability. If equipment configuration or utilization is unknown, the potential operational area must be accurately measured so that when equipment is designated, planners can determine if the site is adequate. Figure 2-1 is an example of a notional water site field layout sketch.

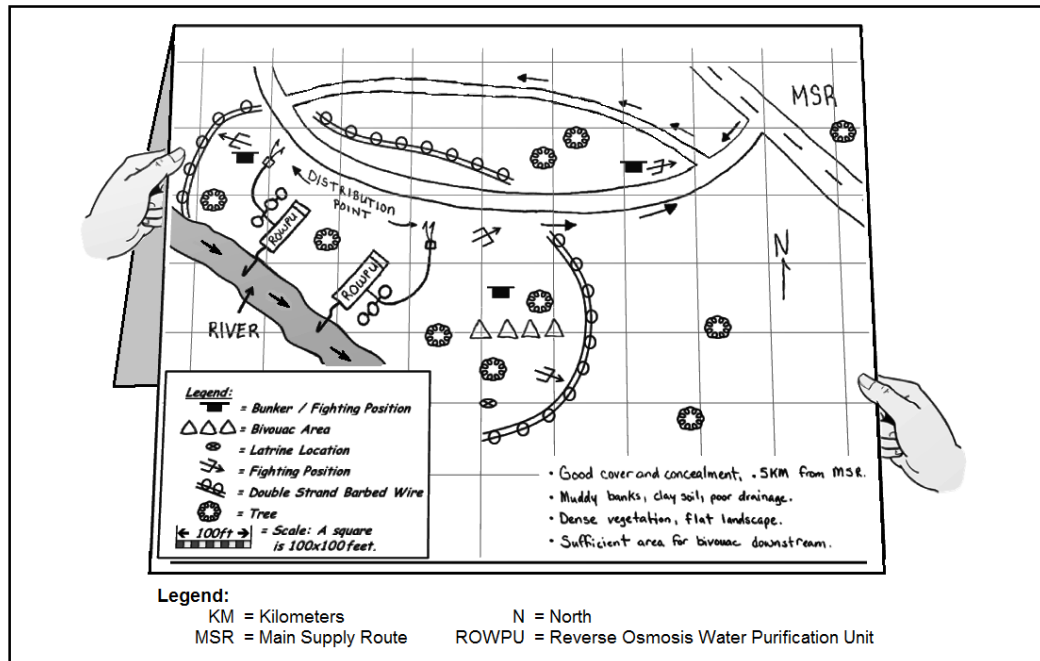

Figure 2-1. Notional water site

Coastal Reconnaissance Operations

2-33. Conducting water treatment operations on a coastline has its own challenges. Avoid problems associated with surf turbulence and storm surge when possible. Plan to locate water treatment systems on sheltered bays, harbors, lagoons or inlets, instead of coastlines. When considering coastal operations, the following generalizations can be made:

- Every coast is different and unique and can vary to extremes in very short distances.
- Coastal ground can range from soft sand to lava and rock.
- Tidal fluctuations can vary as much as 200 feet or more on flat coastal shelves.
- Besides shorelines; bays, harbors, estuaries, lagoons, and inlets are affected by the rise and fall of the tides.

2-34. When planning a reconnaissance for coastal areas, ensure that coastal maps and tidal charts of the area are available. Coastal maps represent the terrain at the shoreline above and below the water line. A steep drop-off on the shore may indicate that the tide may not recede that much at low tide, where as a very flat coastal shelf may indicate the tide will ebb great distances. Tidal charts include the predicted times and heights of the tide for each day. The time between successive high tides averages 12 hours 25 minutes, thus high and low tide will occur twice every 24 hours 50 minutes which is the length of the lunar day. During planning, the water reconnaissance team must also identify areas where landing craft will come ashore so equipment is not emplaced where it could impede landing operations.

2-35. When conducting reconnaissance, be at the potential site at the predicted times for high and low tide. If you cannot be there for both, at least be there for low tide to determine the distance the tide will recede. You can determine the height of the high tide by looking for the distinct cut and debris on the shore that the high tide leaves behind. Determine if the equipment can be safely positioned and operated on the shore. Determine the impact it will have on water treatment operations. When possible, it's also important to talk to the local population about tide fluctuations and storm surge as they know the history and characteristics of the coastal area. Ensure that potential sites are not part of environmentally sensitive ecosystems such as protected coastal areas and wetlands.

2-36. Ensure the site is accessible to all sizes of vehicles that will be entering the site. Vehicles and trailers will bog down quickly in loose sand, especially the heavier reverse osmosis water purification units

(ROWPUs), tactical water purification systems (TWPS) and HIPPOs. Material may be needed to lay down such as wood planking, and steel or fiberglass matting to provide a platform for vehicles to roll over.

PREVENTIVE MEDICINE SUPPORT

2-37. During the water reconnaissance, preventive medicine personnel perform surveys and water testing according to TB MED 577. Preventive medicine uses the testing results and survey findings to characterize raw water sources in terms of their treatability and to establish a basis of comparison for post treatment water test results. Preventive medicine reconnaissance considerations are listed in table 2-1.

2-38. If preventive medicine personnel are not present during the water site reconnaissance, water treatment specialists will collect raw water samples that will be submitted after the reconnaissance is completed. Samples will be submitted to supporting preventive medicine personnel.

Table 2-1. Raw water source reconnaissance considerations

<i>Parameter</i>	<i>Considerations</i>
Water quantity	Is the source permanent or intermittent, depending on season, temperature, or other factors (human controls such as dams)? The greater the source flow and volume, the lesser the impact from added toxic substances (intentional or accidental).
Pollution sources nearby or geographically located so that runoff/discharge may reach the source by surface runoff or subsurface movement	Landfills; agricultural and livestock wastes; industrial discharges; petroleum refineries, distribution, or storage systems; domestic sewage discharges
Visible evidence of contamination	Dead fish or vegetation, excessive algae growth, oil slicks/sludge, or strange-colored soil or surface residues
Potential for contamination from accidents or hostile action	Upstream industrial facilities with significant quantities of toxic industrial chemicals; toxic industrial chemical transportation routes in upstream watershed area; upstream area controlled by hostile forces
Information from local populations	Smells, tastes, health effects and/or endemic water-borne diseases

ENGINEER SUPPORT

2-39. Engineer personnel can provide expertise in terrain and hydraulic analysis, ground survey teams, and well drilling teams. Well drilling teams are located in the Army National Guard, Navy, and Air Force. These teams are typically requested through engineer planners at the division and corps level. During the water reconnaissance, work with engineer personnel to determine if site improvements are possible such as leveling the area, improving drainage, or building roads.

2-40. The AGC hydrologic analysis team and water detection response team (described in paragraph 2-2 and 2-3) should be utilized to help identify optimal locations for drilling a well. Chapter three, paragraph 3-24 through 3-26 has additional information on water-well drilling operations.

2-41. Consideration should be given to work required to make the site useable for a water operation and also work required for improving the efficiency of the site after operations have been established. The engineers will use DA Form 1711 (Engineer Reconnaissance Report) to record work estimate data. The report will provide information on the description of work, man hours required, type of equipment and hours required, and the type of materials and quantity required. A copy of this form should accompany the DA Form 1712. The engineers can also conduct an infrastructure reconnaissance on fixed facilities such as water treatment plants, storage and distribution facilities, power plants, and wells. They collect detailed technical information on the facilities to include operational status and damage assessments.

WATER SITE SELECTION

2-42. Upon completion of water reconnaissance operations, the water reconnaissance team will meet with logistics and operational planners to select the final location of the water site. In some circumstances, multiple reconnaissance teams were sent out to survey primary and alternate water site options. Water reconnaissance reports will be compared against logistics and operational considerations when determining the final water site location. All water site assessment areas outlined in paragraph 2-25 will be considered in determining the viability of a water site. Sites requiring extensive engineer support should be used as alternate sites or eliminated for use.

DEPLOYMENT AND REDEPLOYMENT PLANNING

2-43. Water units must ensure they are ready to deploy to conduct water support operations. As part of deployment readiness, water units must incorporate water planning considerations into unit movement plans and standing operating procedures. During training exercises water units should review, rehearse, revise and validate the standing operating procedures so that every Soldier and Marine understands the deployment process.

LOAD PLANNING

2-44. Load planning is a critical part of deployment planning. The load plan details equipment and supply locations by container or bumper number. Water packing lists may change slightly from mission to mission, but the majority of items are necessary for all water support operations. Based upon raw water source and environmental factors, additional chemicals, filters and reverse osmosis elements may be added to the packing list. Water chemicals requiring hazardous material paperwork should be identified on load plans. Hazardous materials paperwork should be completed as part of deployment readiness training. Appendix B, Deployment Planning Considerations, provides a list of recommended water unit deployment planning considerations (Table B-1 on page B-1). Similar considerations should be implemented into the water unit standard operating procedure. Considerations should be tailored to the unit mission and operational requirements.

INSPECTION REQUIREMENTS

2-45. Preventive medicine personnel should participate in pre-deployment planning and preparation of the plan to provide potable water during deployments. Preventive medicine participation is important because it helps ensure successful execution of the water support mission. In accordance with TB MED 577, field water treatment systems should be inspected by preventive medicine at least semiannually in the operating mode in garrison to ensure deployment readiness. Potable water containers such as water trailers, tank racks, and fabric tanks or drums should also be inspected prior to deployment.

2-46. TB MED 577 establishes potable water standards for the Army. These same standards have been adopted by the Navy, Marine Corps, and Air Force. Water treatment specialists conduct operational monitoring for TDS, turbidity, pH, and free available chlorine to ensure that the treatment system is operating properly and that potable water meets standards outlined in TB MED 577. Preventive medicine personnel conduct additional testing to confirm potability prior to initial distribution and then monthly as recommended in TB MED 577. Preventive medicine personnel inspect water sites using the Defense Occupational Environmental Health Readiness System (DOEHRS) Water Treatment System Inspection Survey and water containers using the DOEHRS Water Container Inspection Survey. TB MED 577 outlines detailed inspection criteria that relates to the aforementioned inspection surveys. Table 2-2 on page 2-10 lists preventive medicine inspection requirements as outlined in TB MED 577.

Table 2-2. Preventive medicine inspections

What	Who			When		
	PM	Owners	Operators	Initial	At and after 30 days	Additional Notes
Raw Water Sources	X			X		Annual Sanitary Survey, Annual AWT
Water Purification points	X			X	Monthly	Semiannual AWT
			X	X	Hourly	FAC, Turbidity, TDS, pH
Storage and distribution facilities	X			X	Monthly	Inspect and FAC
		X	X	X	Daily	
Bottled water storage					Monthly	As requested by units and storage location operators
Unit potable water containers	X			X	Monthly	Inspect and direct cleaning and disinfection as needed
		X			2 x Daily	FAC
Bulk storage	X			X	Monthly	Disinfection
		X	X	X	Daily	FAC
Mobile water storage and delivery	X			X	Monthly	Semiannual Disinfection
		X	X	X	Daily	Logs
Fabric tanks and drums	X				Monthly	FAC
		X		X	Hourly, Daily	
Showers and personal sanitation points	X			X	Monthly	Cleanliness, FAC
		X	X	X	Daily	
Supplies		X		X	Weekly	Order early
AWT = advanced water testing FAC = free available chlorine pH = potential of hydrogen			PM = preventive medicine TDS = total dissolved solids			

ENVIRONMENTAL PLANNING

2-47. Because water treatment involves the use of chemicals, care must be taken to limit any possible hazardous effects on the environment. Caring for the environment protects health, safety, and natural resources. Some states and nations view water treatment as an industrial process that results in industrial waste. For this reason, local laws may require a discharge permit. Local laws may also require a dig permit when constructing or improving a water site. Whenever possible, water treatment personnel should seek to understand local environmental laws and regulations prior to deployment. This will help facilitate water site development. The type of operation, or the stage of an operation, may limit a unit's ability to adhere to local laws and regulations. Logistics planners and water treatment specialists should understand the environmental

effects of operating a water site. Logistics planners and water treatment specialists also have a responsibility to adhere to theater command policies that dictate health and environmental standards.

MARINE WATER PLANNING

2-48. Water support planning within the MAGTF involves collaboration between the supported Marine Corps Service Component Commander, the MAGTF headquarters' staff logisticians and engineers, and subordinate elements of the MAGTF that either require bulk potable water support or provide bulk potable water support. Consumption requirements for the MAGTF are developed using combat planning factors for the size and composition of the force, the duration of the operation, combat intensity, unique environmental conditions (cold, mountainous, jungle, desert, or urban) and other mission variables. The composition of each MAGTF is tailored to accomplish the assigned mission. Similar consideration is given to calculate the quantity and diversity of accompanying supplies that deploy with the MAGTF. To maximize available amphibious or strategic sealift and preserve combat power, MAGTFs rely upon detailed intelligence preparation of the battlespace (IPB) to identify sources of local resources that can be used to conduct sustained operations ashore. Finding and evaluating the suitability of existing sources of raw or potable water is always included during IPB. To facilitate deliberate water support planning, table 2-3 provides the total daily bulk potable water production rate and storage capability for each tactical water support organization in the Marine Corps. Of note, the data in table 2-3 reflects the maximum daily production rate achievable when all of the water purification equipment rated by each organization is fully operational. Actual production rates may be reduced however, based on the quality of the water source, environmental factors, equipment maintenance and other mission variables.

Table 2-3. Marine Corps water production and storage

<i>Unit</i>	<i>Daily Production Rate (gallons)</i>	<i>Storage (gallons)</i>
CLB, MLG	78,000	96,000
CLB, MEU	78,000	45,600
ESB, MLG	840,000	746,000
MWSS, MAG	153,000	300,000
CLB = combat logistics battalion		MEU = Marine expeditionary unit
ESB = engineer support battalion		MLG = Marine logistics group
MAG = Marine aircraft group		MWSS = Marine wing support squadron

2-49. Planners throughout the MAGTF use the Marine Corps Planning Process (MCP) to conduct planning prior to deployment. MCP incorporates IPB, analysis of mission variables, determination of water and other logistics commodity requirements, and staff estimates to determine feasibility of support. During IPB, planners evaluate forecasted consumption rates against available water resources and the MAGTF's bulk water purification, storage and distribution capability. MCP assists the MAGTF commander in developing an operation order for execution. The operation order will finalize details pertaining to force composition (task-organization of personnel and equipment), deployment phasing, concept of operations and concept of logistics support.

2-50. Depending on the mode of transportation used to deploy it to the theater of operations, the MAGTF will be able to leverage the water production capability of amphibious assault vessels or withdraw from bulk water stocks that are located aboard 'host' maritime prepositioning program ships. Maritime prepositioning program vessels use the hoses and pumps of the amphibious bulk liquid transfer system to send bulk water ashore. The amphibious bulk liquid transfer system consists of 10,000 feet of buoyant four-inch hose and pumps which can deliver bulk water to landing force water storage locations ashore. This method of distributing bulk water from maritime prepositioned stocks can be performed while the 'host' vessel is conducting an in-stream or pier-side offload. Accessibility to maritime resources is critical to meet the needs of units employed ashore (especially when the MAGTF's full water purification, storage and distribution capability has not been moved or established ashore).

2-51. Planners in each water support organization will develop detailed plans for task-organization and coordinate the employment of engineer assets (such as water support equipment) using a battle rhythm that supports rapid decision-making and the MAGTF's mission. The water support technicians within each unit

are specifically trained to conduct water reconnaissance, water surveys and water quality analysis. They are also capable of performing a variety of other water support activities including establishment and development of water treatment sites to purify water within a CBRN environment, performance of preventive and corrective maintenance on all Marine Corps water support equipment, and tactical employment of water storage and distribution equipment. Marine Corps water technicians are essentially self-sufficient because they are considered an equipment operator and a maintainer.

Chapter 3

Development of a Water Site

This chapter will discuss water site development and water source improvement. After a water site is selected, it may require development to improve efficiency. In some circumstances, the raw water intake point may require improvement to meet raw water requirements.

WATER SITE DEVELOPMENT

3-1. The development of a water site is the gradual improvement of a water site to increase the quantity and quality of water, and the efficiency of treatment, storage, and issue facilities. Orderly development eliminates bottlenecks and other shortcomings which can occur at water sites.

3-2. A water site may include a raw water source, water intake point, treatment area, storage area, and issue point. The raw water source is the category of surface or ground water that feeds the intake point. The intake point is the location where raw water is pulled from a water source for treatment. The treatment area is the location where water is purified and treated. The storage area is the location where water is stored prior to issue. The issue point is the location where water is issued to end users, or issued for distribution to end users.

3-3. If the water intake point requires improvement, this will become a top priority upon occupation of the water site. The next section of this chapter, Water Source Improvement, will focus on techniques to improve a water intake point. Aside from the water intake point, there are many other site improvements that should be considered.

DRAINAGE

3-4. Wastewater from treatment systems, leakage from tanks, and spillage from distribution facilities keep the water site wet. Poor drainage may prevent movement to and from the water site. Also, during the winter this water may freeze, causing a serious safety hazard for personnel and equipment. Avoid such conditions by having good drainage at each site. Always direct drainage downstream from treatment, storage, and issue activities.

3-5. Water stagnation occurs when water stops flowing. Stagnant water can be a major environmental hazard, and can cause mosquitoes to reproduce. An increase in mosquito population can lead to an outbreak of dengue. Stagnant water can be dangerous for drinking because it provides a better incubator than running water for many kinds of bacteria and parasites. Stagnant water is often contaminated with human and animal feces, particularly in deserts or other areas with low precipitation.

STORAGE FACILITIES

3-6. Storage facilities should be large enough to meet daily peak demands and maintain command directed requirements. This will eliminate long waits at the water point by consumers and ensure sufficient quantities are available for mission requirements. Water treatment personnel may install additional fabric tanks to achieve required storage capability. This is in addition to the tanks issued with water treatment systems. Site considerations for these collapsible fabric bags include level (less than 3-degree slope in 100 yards) and clear terrain. Also, you may use existing host nation or occupied country facilities.

ROAD NETWORKS

3-7. A satisfactory water point must be accessible to vehicles and personnel. A good road network with turnarounds, checkpoints, cover, concealment, and adequate parking are desirable features. The load capacity

of roads should be sufficient to withstand the heaviest vehicles under all weather conditions. Locate the water site on improved roads when possible, while considering the type of operation or unit mission.

TURNOUTS AND TURNAROUNDS

3-8. When water points are located along roads, provide facilities for issuing water without interfering with normal traffic. A turnout may be a widened section of the main road or a new one-way road past the water point (Figure 3-1). For large installations, a turnaround is more convenient and efficient since there is space for water to be distributed to more than one truck at a time (Figure 3-2). The type used depends on labor and equipment available. Drainage is very important, especially if new construction is required for the turnouts or turnarounds.

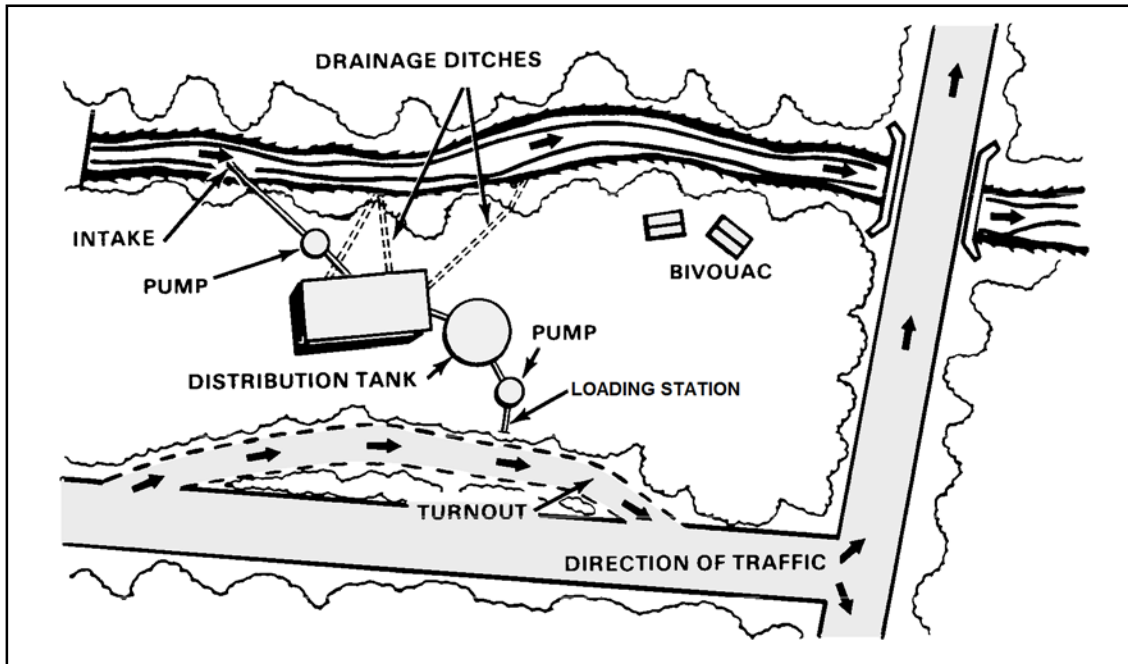

Figure 3-1. Turnout

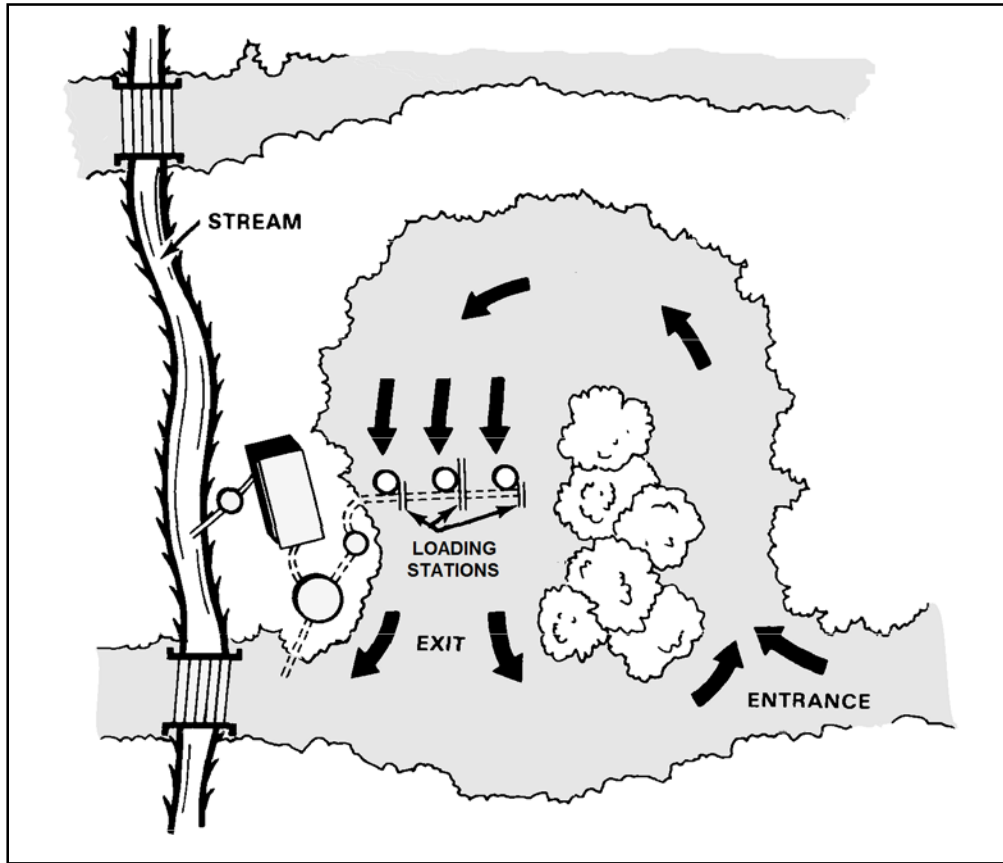

Figure 3-2. Turnaround

TRAFFIC SIGNS

3-9. Water treatment personnel should mark the route to the water point with signs. The signs should be clearly visible to vehicle drivers. Place them so there will be little cross-traffic interference. Also, post them at all critical points within two miles of the water point. Post them at side roads, crossroads, and forks in the road. Place luminous markers on the signs to help direct vehicles during blackouts. The signs should be made in advance and stored with the water equipment for field use.

BIVOUAC

3-10. In addition to the other steps involved in developing a water site, select a bivouac area for water site personnel and security forces. In selecting a location, consider security, facilities, sanitation, and comfort of the troops. Conveniently locate water supply personnel in the vicinity of the water site. Such a location will facilitate the arrangement of shifts and make personnel readily available in case of emergencies. Locate the bivouac area at least 100 yards downstream or down gradient from the selected water source and water equipment. The latrines and trash collection point should be located 100 yards from the water source and bivouac area. See TC 4-02.3, *Field Hygiene and Sanitation*, and ATP 4-25.12, *Unit Field Sanitation Teams*, for additional information.

WATER SOURCE IMPROVEMENT

3-11. The raw water intake point, which pulls from the water source, may need to be improved to meet raw water quantity and quality requirements. Improvement of a water intake point includes all work that increases the quantity of water, improves its quality, or makes it more readily available for treatment.

3-12. All intake hoses or pipes should have an intake screen regardless of how clear the water appears. Protect suction screens from floating debris, which may damage, clog, or pollute them. Proper anchorage of suction lines and screens prevents puncture of kinked lines, damage to the screen, and loss of prime. In addition, water at the intake point should be as clear and deep as possible. The screen on the suction hose must be at least eight inches below the water level and eight inches above the bottom of the source (unless depth of source is too shallow). This helps to keep the screen from becoming clogged with floating debris. It also prevents loss of prime from air getting into the suction line.

3-13. Suction lift decreases at higher altitudes. In addition, the pumps must create a partial vacuum in the suction line. Therefore, the raw water intake hose must be airtight for the pump to work properly.

DEVELOPMENT OF SURFACE WATER SOURCES

3-14. Surface water is easy to find and easy to develop. Surface water sources can be accessed with military water treatment systems, with little engineer support required. When using a shallow raw water source, improvements may be required to ensure an adequate intake point when there is insufficient depth to accommodate the purification equipment's floating strainer. There are various techniques for constructing intake points for surface water sources utilizing the purification equipment's ice hole strainer or commercially purchased strainer.

Rocks and Stakes

3-15. When streams and shallow lakes are used as a raw water source, rocks and stakes may be used to anchor the intake screen at an optimal depth. This will prevent clogging of the screen by a streambed or lakebed, and provide enough water overhead to prevent the suction of air into the intake screen. Figure 3-3 presents a visual example of the stake method.

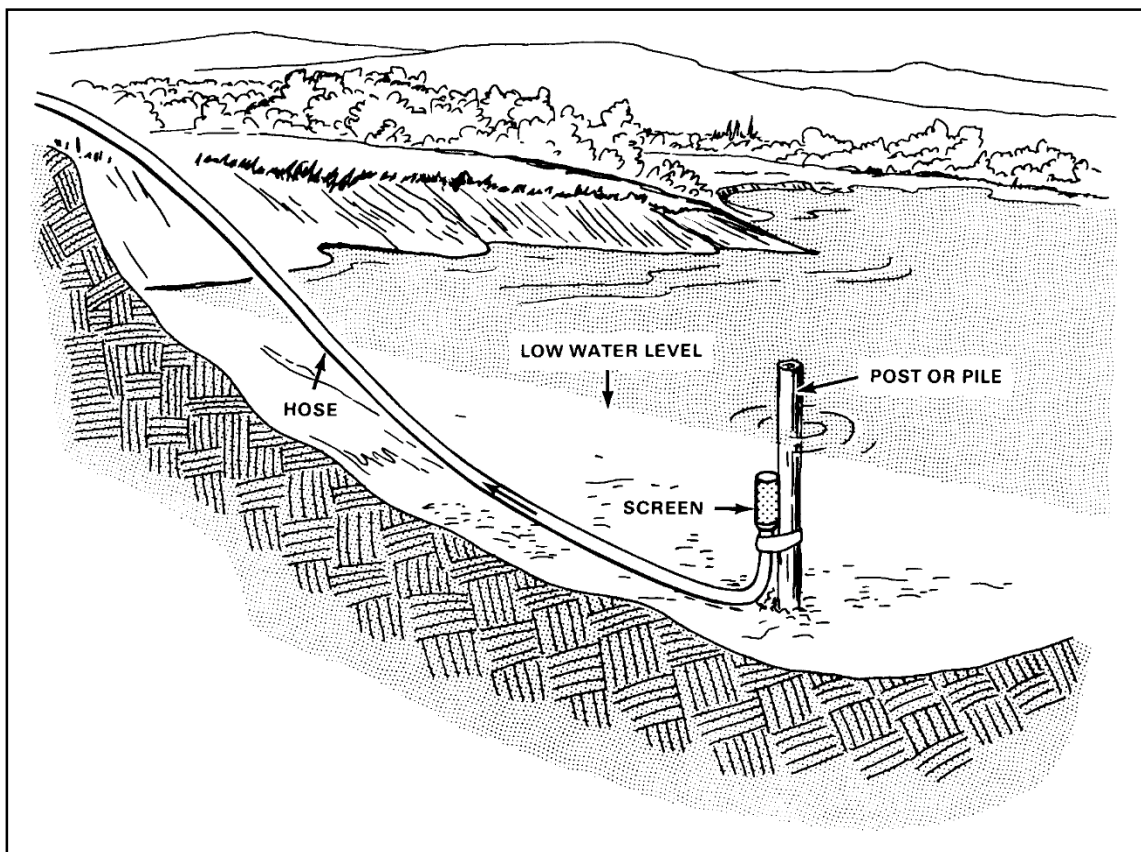

Figure 3-3. Stake method

Pits

3-16. When a stream is so shallow that the intake screen is not covered by at least 4 inches of water but the source must be used, a pit should be dug to increase the depth at a section of the stream. Line pits dug in streams with clay or silt bottoms with gravel to prevent dirt from entering the water treatment systems. Surround the screen with gravel to prevent collapse of the sides of the pit and to shield the screen from damage by large floating objects. The gravel also acts as a coarse screen for the water. Enclosing the intake screen in a bucket is another way to create a shield. Figure 3-4 and 3-5 show visual examples of the pit method.

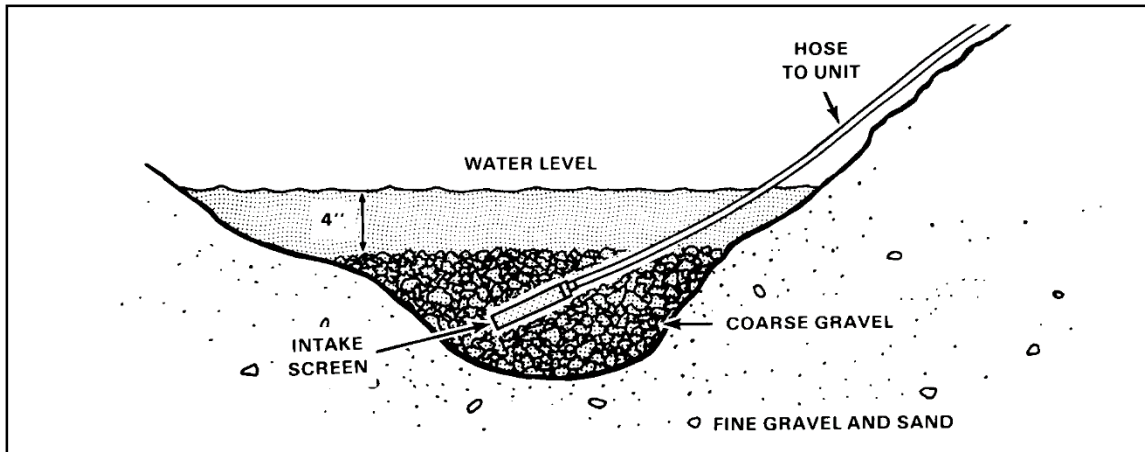

Figure 3-4. Gravel pit method

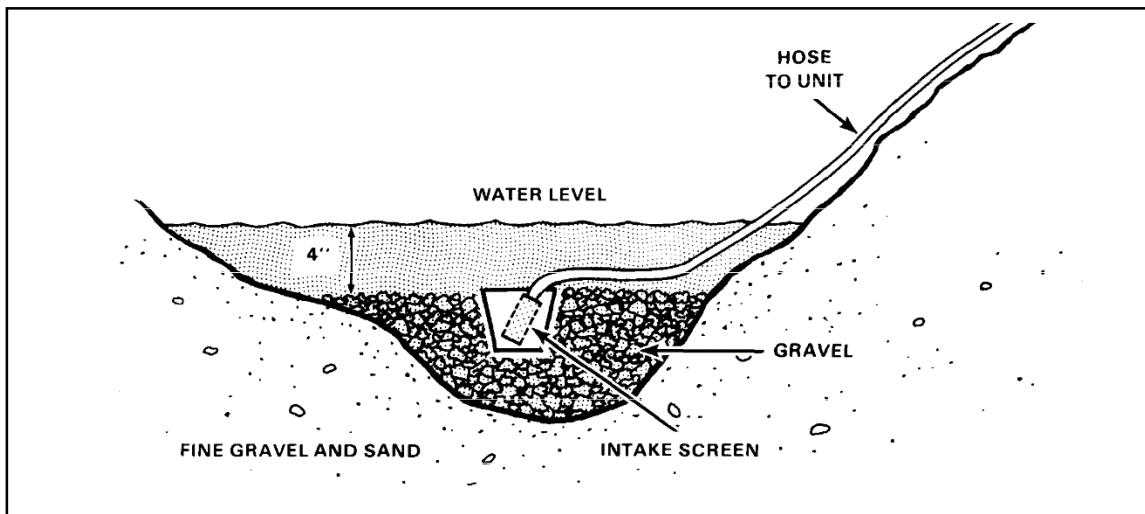

Figure 3-5. Gravel pit method with bucket

Dams

3-17. Raise the level of the water in small streams to cover the intake screen by building a dam. In swift flowing streams, construct a wing or baffle to protect the intake screen without impounding the water. Figure 3-6 and 3-7 on page 3-6 show visual examples of a dam and baffle dam respectively.

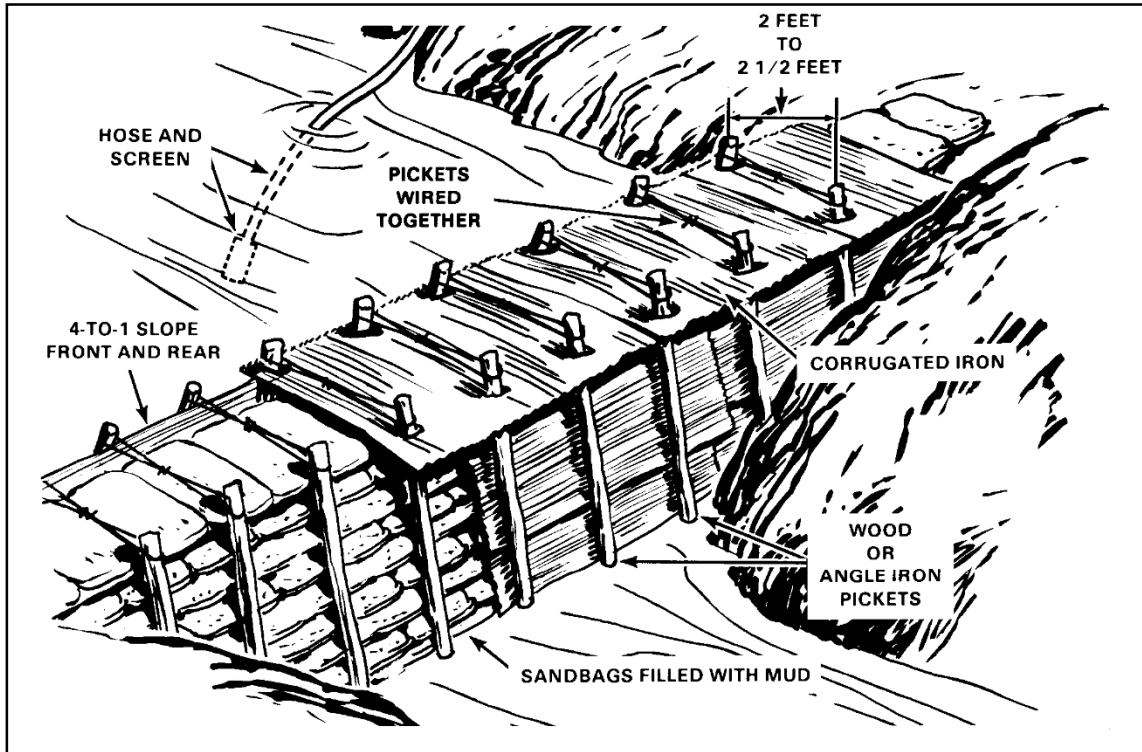

Figure 3-6. Improvised dam

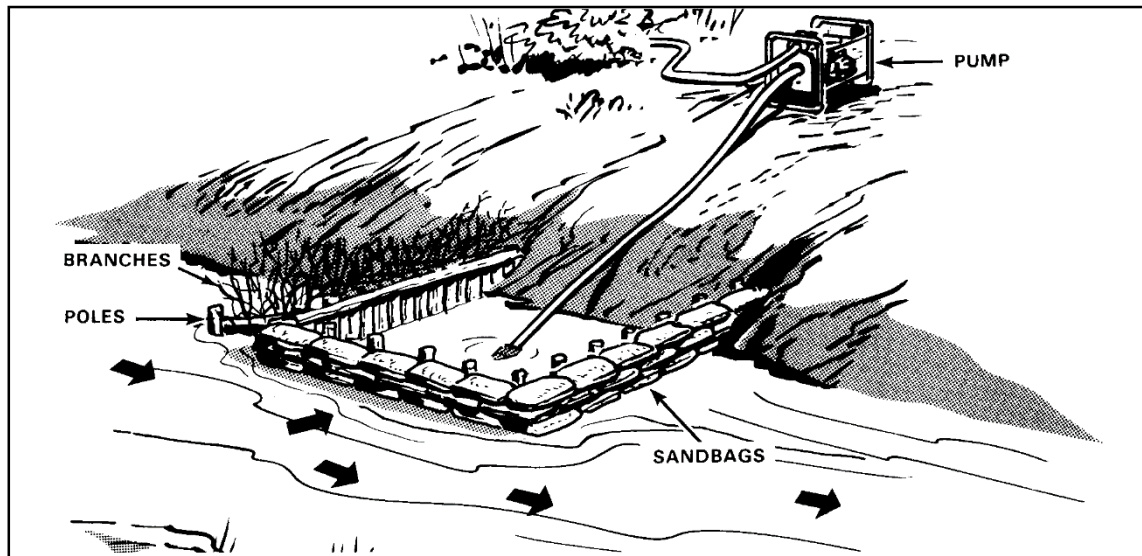

Figure 3-7. Baffle dam

Floats

3-18. Commercial or field expedient floats can be used to position an intake screen in deep water. They are especially useful in large streams where the quality of the water varies across its width or where the water is not deep enough near the banks to cover the intake screen. Cover the intake with an adequate depth of water by anchoring or stationing the float at the deep part of the stream. Secure the intake hose to the top of the float, allowing enough slack for movement of the float. If using support lines to secure the float to the banks,

alter the position of the float to correspond to changes in depth by manipulation of the lines. The chief advantage of a float intake is the ease with which the screen can be adjusted vertically.

Galleries

3-19. Engineers can improve the quality of water from muddy streams by digging intake galleries along the bank. To do this, they dig a trench along the bank. The trench must be deep enough to allow the water from the stream to seep into it and to intercept ground water flowing toward the stream. They fill the trench with gravel to keep the sides from collapsing. Then they place the intake screen in the gravel below the waterline. A gallery requires a lot of work, but it may be worth it. It reduces the amount of chemicals needed for coagulation, extends the life of filter cartridges, and extends the filter run between backwashing.

DEVELOPMENT OF GROUND WATER SOURCES

3-20. When surface water supplies are inadequate or unusable, ground water supplies should be developed as a raw water source. Subsurface or ground water is water existing below the earth's surface. About 97 percent of the earth's fresh water (not counting the fresh water frozen in the polar ice caps and glaciers) is located underground in *aquifers*. In most regions, the ground is saturated with water to a depth that depends largely on the type of rocks and soil, the amount of rainwater, and the topography of the land. Ground water is accessed by water treatment specialists through springs or man-made wells.

3-21. Developing a groundwater supply has many advantages over using surface water. Groundwater is more abundant than surface water, is often cleaner, requires less treatment, and may be easier to protect than surface-water supplies. A water well is easy to seal from natural contamination and to protect from clandestine contamination. Groundwater supply remains unaffected by short-term drought unless it relies directly on surface sources.

Spring Development

3-22. Water which emerges at the surface naturally with a distinct current is called a spring. When a distinct current is not present, the flow is called a seep. Develop a spring by enlarging the outlet of the spring and by building a dam and guiding the water to storage. To reduce possible pollution, clear a spring of all debris, undergrowth, top soil, loose rocks, and sand. Improve springs by building collecting boxes or digging ditches and tunnels. Collecting boxes or basins can be of wood, tile, or concrete. They collect water, which flows, from rocks under the force of gravity. The box should be large enough to hold most of the flow. Place it below the ground level so that only the top is slightly above the surface. Tightly cover the box to prevent contamination and decrease evaporation. Design the inlet to keep out surface drainage and prevent pollution. Fence the area and provide proper drainage. A screen on the overflow pipe keeps out insects and small animals. Another screen on the intake pipe keeps large suspended particles from being taken in by the raw water pump.

3-23. To get water from a seep, dig deep narrow ditches leading from the spring to the intake point. Another method is to build pipeline tunnels from the spring to the intake point. Large-diameter pipe is more suitable for this purpose. Trap water from ditches or pipes by a constructing a dam at the intake point.

Man-Made Wells

3-24. Man-made wells may be existing, or may require construction by military well drilling teams. Existing wells must be inspected to determine if quantity and quality requirements can be met. Existing wells may require improvement by engineer personnel prior to use.

3-25. In the case that an existing well does not exist, or an existing well cannot be improved to achieve raw water requirements, a new well should be constructed by an engineer well drilling unit. Water treatment specialists may receive support from joint engineer partners in the Army, Navy, or Air Force. Army well drilling units are located in the Army National Guard, but operational control (OPCON) to a JTF or operational headquarters when forward deployed. Navy well drilling capabilities are located within Naval Mobile Construction Battalions, also known as Seabees. The Air Force assigns well drilling units to Rapid Engineer Deployable Heavy Operational Repair Squadron Engineers, also known as RED HORSE.

3-26. TM 3-34.49/NTRP 4-04.2.13/AFMAN 32-1072, *Water-Well Drilling Operations*, provides general information for engineer personnel responsible for planning, designing, and drilling wells, focuses on techniques and procedures for installing wells, and includes expedient methods for digging shallow water wells, such as hand-dug wells.

Types of Man-Made Wells

3-27. Wells are classified into five types, according to their method of construction. The five types of wells are discussed below:

- A dug well is one in which the excavation is made by the use of picks, shovels, spades, or digging equipment, such as sand buckets or clamshell buckets.
- A bored well is one in which the excavation is made by the use of hand or power augers.
- A driven well is constructed by driving a pointed screen, referred to as a drive point, into the ground. Casings or lengths of pipe are attached to the drive point as it is being driven into the ground.
- A jetted well is one in which the excavation is made by use of a high velocity jet of water. However, in some regions of the Arctic, steam is used for jetting instead of water.
- A drilled well is one in which the excavation is made by either percussion or rotary drills. The excavated material is brought to the surface by means of a boiler, sand pump, suction bucket, hollow drill tool, or hydraulic pressure.

Hydraulics of Wells

3-28. Before a well is pumped, the water level is the same as the level of the surrounding *water table*. Measure the depth from the ground surface to the water level. This distance is called the static level of the well. Thus, if the water in a well is 25 feet below ground, the static water level is 25 feet. Elevation of the static water level above mean sea level can also describe its position.

Pumping Level

3-29. When a well is pumped, the static water level drops. After several hours of pumping at a constant rate, it stabilizes itself in a lower position. This is called the pumping level or dynamic water level for this rate of pumping.

Drawdown

3-30. The distance that the water is lowered by pumping is called drawdown. It is the difference between the static level and the pumping level. The drawdown in the well, resulting from the pumping, lowers the water pressure in the well; but the surrounding water-bearing soil retains its original pressure. In response to this difference in pressure, water flows out of the soil into the well.

Intrusion

3-31. Along coastal areas and on islands, there is always the danger of saltwater intrusion into ground water sources. Analysis can accurately determine the degree of salinity. When discovering saltwater intrusion in the ground water supply, take steps to determine the cause. When small amounts of fresh water exist on islands and peninsulas, conservation is usually necessary to prevent saltwater intrusion. The amount of fresh water that can be pumped without intrusion of saltwater depends on local conditions, type of well, rate of pumping, and the rate of recharge of the sand by fresh water.

3-32. In areas of high rainfall, the recharge rate of the sand is usually rapid; but if the rainfall is seasonal, the wells may become dry if water is not rationed during the dry period. A rise in the level of the saltwater occurs if the head (amount) of fresh water is reduced for any reason such as excessive pumping or a decrease in rainfall. The drawdown in the fresh water level around the well causes a rise in the underlying saltwater. Restrict pumping of any one well according to drawdown, for saltwater will enter the well if drawdown is maintained greatly below sea level for extended periods. The pumping rate should not exceed the rate of recharge.

Well Yield and Drawdown

3-33. Pumping tests are made on wells to determine their replenishment rate in addition to other hydraulic characteristics, and to obtain information so that permanent pumping equipment can be skillfully selected and used. Preliminary tests of wells drilled as test holes are sometimes made to compare the yielding ability of different water-bearing formations or different locations in the same formation. Use this information as a basis for selecting the best site for a supply well and the aquifer in which it should be completed. Engineer well drilling units conduct these tests. However, if engineer units do not test the completed well, water treatment specialists must conduct these tests.

3-34. The measurements that should be made in testing wells include the volume of water pumped per minutes or per hour, the depth to the static water level before pumping is started, the depth to the pumping level at one or more constant rates of pumping, the recovery of the water level after pumping is stopped, and the length of time the well is pumped at each rate during the testing procedure.

3-35. The specific capacity of a well is its yield per foot of drawdown, usually expressed as gallons per minute per foot of drawdown. The specific capacity is not constant for all values of drawdown but is nearly so for wells tapping very thick aquifers and wells operating under artesian conditions. Normally, the specific capacity of a well decreases with increased drawdown. The specific capacity indicates the relative yield of a well.

DEVELOPMENT OF SALTWATER SOURCES

3-36. Water support operations may require deployment of water treatment systems to operate on coastal raw water sources. This section provides insight into techniques necessary to overcome operational difficulties associated with water treatment at coastal sites. Factors to be considered in developing saltwater sources are surf action, saltwater corrosion, suspended sand and silt in the water, living organisms, surface oil along beaches, and the rise and fall of the water level with the tide. In Arctic regions, another factor is the potential for damage to raw water supply lines from ice floes washing onto the beach. In all regions, locate water treatment systems on sheltered bays, harbors, lagoons, or inlets when possible. Supply raw water by intakes constructed the same as surface intakes for fresh water. On open beaches and small islands, saltwater wells or offshore intakes can be constructed.

Saltwater Wells

3-37. Saltwater (beach) wells are preferred to offshore intakes because they eliminate problems caused by tides, surf, and shallow water close to shore. Driven and jetted wells can be dug to tap brackish or ground saltwater at sandy beach locations. Another advantage of such wells is that they can be constructed behind the shoreline under natural overhead concealment. A disadvantage of saltwater wells is the possibility of hydrogen sulfide content in raw water and under certain conditions, water exiting the pump may have an offensive “rotten egg” odor. This is due to the presence of hydrogen sulfide gas. Sulfur-reducing bacteria are the primary producers of large quantities of hydrogen sulfide. These bacteria use sulfur as an energy source, chemically changing natural sulfates in water to hydrogen sulfide. When dealing with water containing hydrogen sulfide gas, you should be aware of the following:

- The reverse osmosis elements, multimedia filtration, microfiltration and ultrafiltration will not remove gaseous hydrogen sulfide.
- Hydrogen sulfide in the water will result in pump seal failures, pump impellor corrosion and eventual corrosion of the piping.
- Adding chlorine to product water containing hydrogen sulfide gas will cause the gas to change from a gas to a solid (free sulfur), causing the water to become cloudy in appearance.
- The ocean intake structure system (OISS) section below provides ways to mitigate the presence of hydrogen sulfide.

Offshore Intakes

3-38. Offshore intakes are sometimes required due to lack of time, personnel, or equipment required to develop beach wells. In addition, coral formations sometimes prevent construction of beach wells. When

constructing offshore intakes, the raw water intake point is placed directly in the water source. Floating intake strainers must be securely anchored when used at costal water sites. When environmental conditions prevent use of a floating intake strainer, the ocean intake structure system OISS may be employed to create a secure offshore intake.

Ocean Intake Structure System (OISS)

3-39. The OISS can be used by water treatment specialists to drill well heads or create offshore intakes during costal operations. The OISS is a component of the TWPS and can also be used with the ROWPU. The OISS is not a component of the ROWPU, however, it can be purchased separately. The OISS is designed to extract seawater and feed raw water into a TWPS or ROWPU (it can also be used for freshwater sources). It can be arranged in three different configurations to match the environmental conditions of a costal site. For sandy beach areas and optimum performance, well heads can be jetted into the ocean floor using water to fluidize sand and sink the wellpoint. Risers are added to the wellpoint to aid in extracting water from areas where the water level is greater than four to six feet below the sand level. This is especially important when water levels retreat away from pumping locations during low tide.

3-40. Two additional methods are used when conditions will not permit jetting wells. They are the vertical and horizontal position methods, which allow wellpoints to be placed directly in the water. The vertical position method consists of wellpoints attached to metal stakes that have been driven into the ocean floor (see figure 3-8). In the horizontal position method, the wellpoints are laid flat in the water on the ocean floor with the wellpoints connected together directly to the tees (see figure 3-8). The vertical and horizontal positions are especially applicable to extracting water from a fresh water source, when jetting a well is not possible. Refer to the TWPS TM for initial setup and layout of the OISS.

3-41. All of these installation techniques should be performed at maximum low tide. This should eliminate the need to move the wellpoints as tides change. Low tides normally occur twice a day with one being significantly lower than the other. It is during the extreme low tide that the OISS should be positioned. The movement of the tide will cause changes in the flow produced by the OISS. At high tides, flows will be the greatest since the water is closer to the pump. During low tide conditions water will be further from the pump, increasing suction lift.

3-42. To avoid or mitigate hydrogen sulfide gas, water treatment specialists can aerate raw water and treat with citric acid. To aerate water, spray water through the air as it is pumped into a 3,000 gallon raw water tank. Aerating the raw water will cause hydrogen sulfide gas to change to a solid (free sulfur). When this water is pumped into the water treatment systems, the sulfur should be removed by the multimedia filter or microfiltration assembly. In addition, citric acid can be added to the raw water tank to reduce the amount of sulfur to a pH level between four and five.

3-43. Vertical wellpoints can be connected together and positioned directly in the water, either attached to stakes vertically or laid on the ocean floor in the horizontal position. When using the vertical configuration, 5-foot risers are replaced with 6-inch risers. The two 10-foot sections of suction hose between the wellpoint and the tee are not required, and the wellpoints can be connected directly to the tee as an option. The wellpoints should be installed at low tide to ensure that the wellpoint screen is submerged below the low tide water line. This will ensure that water intake holes located at the lower end of the steel jetting pipe are completely submerged, regardless of tide conditions.

3-44. When installing the OISS in the horizontal configuration, hoses are positioned and connected in the same way as with the vertical method. The two 10-foot sections of suction hose between the wellpoint and the tee are optional, and the wellpoints can be connected directly to the tee. However, a major difference between the vertical and horizontal configurations is that the wellpoints are laid horizontally, flat on the ocean floor. When laid on the ocean floor, the wellpoint must utilize the plastic boot or be taped closed. This is because the floating ball check valve in the jetting shoe of the wellpoint was designed to operate in the vertical position only. With the horizontal orientation of the wellpoint, there is a possibility of faulty operation of the ball check valve. To aid the horizontal position, a trench may be dug on beach where the wellpoint can be securely anchored and monitored. Figure 3-8 depicts the difference between vertical and horizontal configurations.

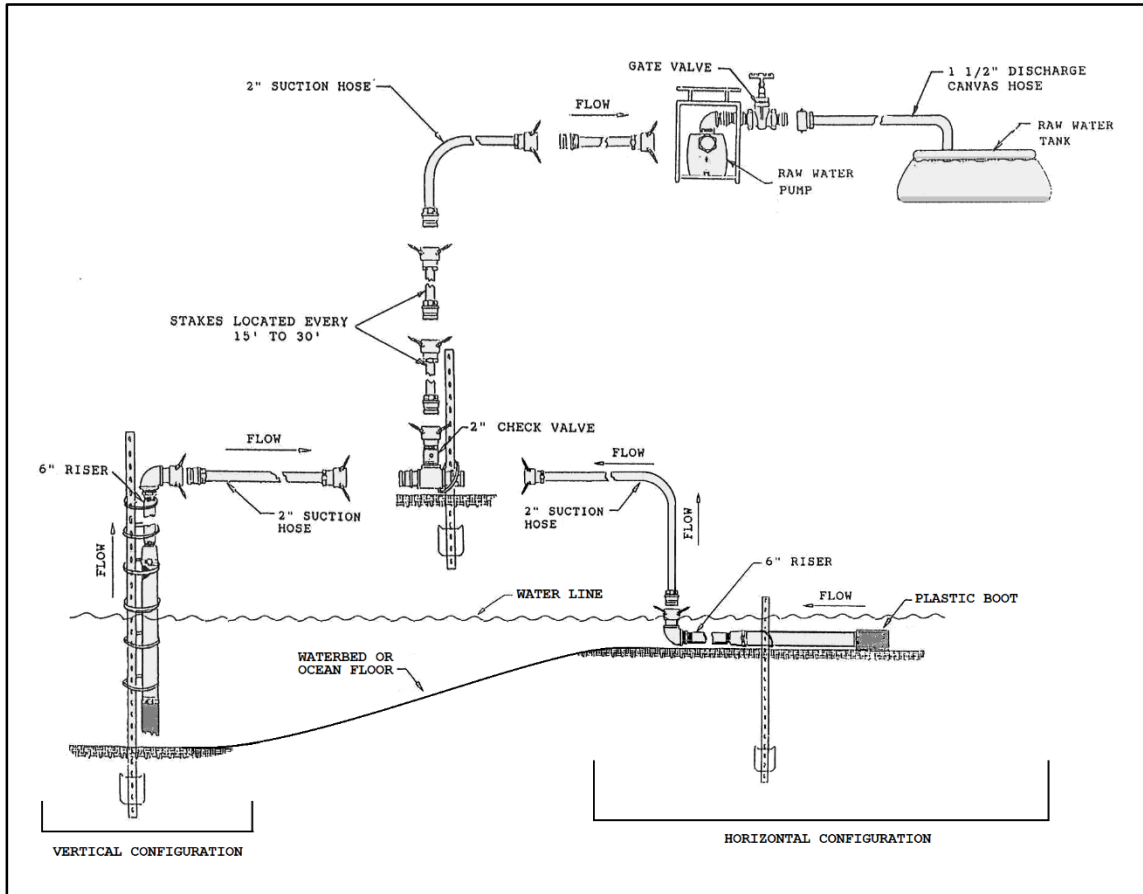

Figure 3-8. Ocean Intake Structure System (OISS) vertical and horizontal configuration

3-45. There are specific safety considerations to be aware of when operating the OISS. The OISS electrical circuits contain high voltages when in operation. Death on contact may result if personnel fail to observe safety precautions. Do not attempt inspection or maintenance while equipment is connected to a power source. When sand is fluidized during well construction, the area near the hole may become wider. This could result in loss of solid footing, and an operator could fall into the hole being drilled. This could result in death by drowning. The OISS operator must be tied off to a safety harness and wear a personal flotation device when drilling wells. Ensure that there are at least two personnel present when wellpoints are being drilled.

This page intentionally left blank.

Chapter 4

Water Treatment Operations

This chapter will discuss water treatment operations. The water treatment process ultimately turns raw water into potable water, which is safe for human consumption. The sections of this chapter include a water quality overview, operator water treatment planning, and water treatment systems.

SECTION I – WATER QUALITY

4-1. This section will begin with a water quality overview and information on water quality standards. The water treatment process will then be discussed in detail, to include filtration, reverse osmosis, and disinfection.

WATER QUALITY OVERVIEW

4-2. Water quality has two major areas of concern within the water treatment process. The first is the quality of the raw water source. The nature of the raw water source will dictate the amount of water each purifier can produce, the stability of purifier components, and the amount of treatment chemicals required. Each military water treatment system has design limits for total dissolved solids (TDS), above which it would not be possible to produce potable water in a single-pass configuration. Consult the respective technical manual for the operational limits of the system to be employed. Raw water turbidity will also impact the efficiency of water production and the rate at which filters clog. As discussed in chapter two, raw water source samples are collected during water reconnaissance operations, and quality results will be used in determining the selection of a water site. Choose the best source available and pursue improvements to the intake as discussed in chapter three.

4-3. The second water quality concern is product water. Product water has been purified and disinfected, but is not considered potable until certified by the theater or command surgeon's representative (normally a preventive medicine specialist). Any water in the field, whether raw or treated, that has not been approved for consumption by preventive medicine is considered non-potable. Non-potable water sources (such as taps or spigots) must be marked with signs that read "NON-POTABLE WATER DO NOT DRINK." In the event that preventive medicine personnel cannot test military purification system produced water in a timely manner, senior noncommissioned officers and supervisors of water production systems and operations may distribute the water for drinking and other activities on a provisional basis until preventive medicine personnel are available for testing and approval (TB MED 577).

4-4. Chemical analyses and microbiological examinations of raw and *treated water* are required on a routine basis at water sites. Chemical tests are necessary to ensure correct operation of the water treatment system. Chemical analyses are continuously conducted during treatment to ensure proper chemical dosages and that the product water is potable. Microbiological examinations are conducted after treatment at water storage and distribution sites to determine the potability of the water. Until the water is issued to the using unit, water quality is monitored and must contain a residual chlorine level at the standard prescribed by the command surgeon. Water testing kits used by preventive medicine and water treatment specialists are described in TB MED 577 and appropriate technical manuals (TMs).

HYDROLOGIC CYCLE

4-5. The hydrologic cycle is the term used to describe the natural circulation of raw water in, on, and above the earth. Water occurs in many forms as it moves through this cycle. The steps in the hydrologic cycle include precipitation, infiltration, runoff, evaporation, transpiration, and condensation. Water is placed in the

air by evaporation from water and land surfaces and by transpiration from plants. It then condenses to produce cloud formations and returns to earth as precipitation. Some of this evaporates, while some flows as runoff into lakes and streams. The remainder goes into the soil and then into underlying rock formations by seepage or infiltration. The water which has seeped through the earth will finally find its way to the surface through springs. It can also flow through porous media until intercepted by streams, lakes, or oceans. The cycle does not always progress through a regular sequence; steps may be omitted or repeated at any point. For example, precipitation in a hot climate may be almost wholly evaporated and returned to the atmosphere.

IMPURITIES IN WATER

4-6. Water is a universal solvent that absorbs the chemical makeup of materials it comes into contact with. As water goes through the hydrologic cycle, it gathers many impurities. Dust, smoke, and gases fill the air and can contaminate rain, snow, hail, and sleet. As runoff, water can pick up silt, chemicals, and pathogens. A pathogen is a disease producing microorganism (virus, bacteria, prion, fungus, or parasite) that directly attacks human tissue and biological processes. As water enters the earth through seepage and infiltration, some of the suspended impurities may be filtered out. However, other *minerals* and chemicals are dissolved and carried along. As ground water in underground deposits, it may contain pathogens as well as harmful chemicals. In addition to the impurities in water resulting from infiltration, many are contributed by an industrialized society. Garbage, sewage, industrial waste, pesticides, and NBC agents are all possible contaminants of raw water. Impurities in raw water are either suspended or dissolved. Suspended impurities include disease organisms, silt, bacteria, and algae. They must be removed or destroyed before the water is consumed by Soldiers and Marines. Dissolved impurities include salts, (calcium, magnesium, and sodium), iron, manganese, and gases (oxygen, carbon dioxide, hydrogen sulfide, and nitrogen).

RAW WATER CLASSIFICATIONS

4-7. Classification of water is based on the concentration of TDS and is classified as fresh, brackish, or salt water (seawater). Generally, ground water (subsurface) has less chemical or biological contaminants than surface water, provided reasonable care is exercised in the selection of the well site. As discussed in the Hydrologic Cycle, harmful microorganisms are usually reduced to tolerable levels by passage through the soil. Classification standards for raw water are as follows:

- Fresh water has a TDS concentration of less than 1,500 ppm.
- Brackish water is high in minerals and has a TDS concentration between 1,500 ppm and 30,000 ppm.
- Salt water (seawater) has a TDS concentration greater than 30,000 ppm.

4-8. Raw water is sourced from surface or ground water. Surface water includes streams, rivers, ponds, lakes, seas, and oceans. Ground water includes springs and wells.

TREATED WATER CLASSIFICATIONS

4-9. Treated water may be classified as potable and palatable. Potable water is defined in TB MED 577 as water that does not contain disease producing organisms, poisonous substances, and chemical or biological agents and radioactive contaminants at levels which produce disease or injury. Potable water may or may not be palatable.

4-10. *Palatable water* is pleasing in appearance and taste. It is significantly free from color, and foul taste or odor. Water is more palatable to the consumer in an arid environment when it is cooler and aerated. Cooler water encourages acceptance. Therefore, efforts to maintain water at the optimum temperature (60 degrees Fahrenheit or 16 degrees Celsius) should be made by shading or other means, such as mechanical water chillers or adding potable ice. Palatable water may also not be potable. Therefore, leaders must ensure that Soldiers and Marines comply with guidelines restricting consumption of raw untreated water.

FIELD WATER QUALITY STANDARDS

4-11. Water Quality standards were developed to protect Soldiers and Marines against performance-degrading effects resulting from the ingestion of field water in an area of operations. Standards for field water

quality were developed for field water constituents and impurities that naturally occur or have been introduced by man into the water (TB MED 577). DOD military field water standards for water quality are applicable to drinking water quality in a military field environment.

MULTINATIONAL AGREEMENTS

4-12. Field water quality standards have been developed by international agreements among North Atlantic Treaty Organization (NATO) Forces. NATO countries have agreed when operating on land, to adopt minimum requirements for potability of drinking water to be issued to troops in combat zones or in any other emergency situations. The two agreements that encompass water quality standards are the NATO Standardization Agreement (STANAG) 2136, *Requirements For Water Potability During Field Operations and in Emergency Situations*, and NATO STANAG 2885, *Emergency Supply of Water in Operations*. As a member nation of NATO, the U.S. has agreed to accept and provide water meeting these standards when participating in multi-national water support operations. DOD standards are as stringent as or more stringent than the minimum multinational standards.

SHORT TERM AND LONG TERM CONSUMPTION STANDARDS

4-13. Short term and long term consumption standards (standards in STANAG 2136 are referred to as emergency and routine water standards) are outlined in TB MED 577. An operational situation may exist which prevents Soldier or Marine access to drinking water meeting long term consumption standards (greater than 7 days). The short term standards (less than 7 consecutive days) for potable water is less stringent than the long term standards. Commanders must accept the risk of potential troop performance degradation, increased incidence of disease, casualties from toxic substances, and reduced combat efficiency with each day the imposition remains in effect. Commanders must routinely consult preventive medicine personnel on the use and impact of short term standards and the potential health hazards.

4-14. Long-term consumption standards are equal to Environmental Protection Agency (EPA) developed municipal drinking water system's standards. The standards in TB MED 577 apply to all situations that continue for more than 7 days where potable water is produced by water treatment units. These standards should be adopted as a goal to provide the highest quality water possible to the Soldiers and Marines in an area of operations.

POTABLE WATER QUALITY STANDARDS

4-15. Potable water must be of the highest quality possible to ensure combat readiness of Soldiers and Marines is not degraded. Standards are used to measure the physical, chemical, microbiological, and radiological quality of water and to test for the presence of chemical agents. Military Field Water Standards (TB MED 577) are applicable to water produced by military water support units, bottled water, tactically-packaged water by military units, and host nation water. Too little chlorine residual may result in water not being safe to consume. Too much chlorine residual may result in Soldiers or Marines not wanting to consume the treated water and produce severe dehydration or laxative effects.

Physical Quality

4-16. The principal physical characteristics of water are color, odor, taste, turbidity, and temperature. Each of these is described as follows:

- Color in water comes from colored substances, such as vegetable matter, dissolved from roots and leaves, from humus, or from inorganic compounds such as iron and manganese salts. The clear color standard is designed to make drinking water more palatable.
- Odor and taste found in water are most commonly caused by algae, decomposed organic matter, dissolved gases, or industrial waste. There are no set standards for odor and taste and there are no specific tests for these. The treatment process removes tastes and odors which make water not palatable to Soldiers and Marines in the field.
- Turbidity is a muddy or unclear condition of water caused by suspended clay, silt, organic and inorganic matter, and plankton and other microorganisms. The turbidity standard was established

to improve the efficiency of *disinfection* by reducing particles to which microorganisms could attach.

- Temperature relates to the palatability of the treated water and to the chlorination and purification of water. Warm water tastes flat whereas cooling the water suppresses odors and tastes and makes it more palatable. Disinfection takes longer when water is colder, and purification capacity is reduced while using reverse osmosis treatment equipment. When water of low physical quality must be used, the appropriate command level will make that decision based on medical recommendations.

Chemical Quality

4-17. The chemical quality of water depends on the chemical substances it contains and the effect the water will have on the health of a Soldier or Marine. The effect of a particular chemical substance determines if a limit is established for that substance. These substances include TDS, chlorides, sulfates, and other ions. The chemical quality of water involves its hardness, alkalinity, acidity, and corrosiveness. **Alkalinity is the content of carbonates, bicarbonates, hydroxides, and occasionally berates, silicates, and phosphates in water.** Chemical substances having an adverse health effect have established standards that will not be exceeded without medical approval. Generally, the amount of product water produced is inversely proportional to the amount of substances that the water contains. Specific standards are defined in TB MED 577. These substances are described below.

Potential Hydrogen (pH)

4-18. The pH is a measure of the acidic or alkaline nature of water. It is technically defined as the negative logarithm of the hydrogen in concentration. It ranges from 0 to 14. A pH value of 7 is neutral. The pH directly influences the corrosiveness of the water, the amount of chemicals needed for proper disinfection, and the ability of an analyst to detect contaminants. Water with a pH below 7 is regarded as acidic while water with a pH above 7 is regarded as alkaline. The pH standard was established to ensure effective purification and disinfection.

Arsenic and Lewisite

4-19. Arsenic may be present in natural water sources in a wide range of concentrations. It can come from either natural or industrial sources. Ingestion of low concentrations of arsenic can cause nausea, vomiting, abdominal pain, or nerve damage. In high doses it can kill. The standard for arsenic was established to ensure no adverse health effects would occur to degrade Soldier or Marine performance. Lewisite is an organic trivalent arsenic compound that is a threat agent; ingestion of lewisite can cause gastrointestinal injury and may be lethal.

Chloride

4-20. The health effects of greatest concern for military populations exposed to elevated concentrations of chloride ion in field water assets are associated with the dehydration of military personnel who reduce their consumption of field water because of its poor taste. Chloride might also produce laxative effects at concentrations exceeding 600 milligrams per liter (mg/L), but leaders must be more concerned with dehydration rather than the laxative effects.

Cyanide

4-21. Cyanide can be present in natural water from industrial sources, such as metal processing, coke production, mining, or photograph development. Chlorination of water containing hydrogen cyanide results in the formation of cyanogen chloride, a toxic chemical agent. Exposure to cyanide in drinking water can lead to a variety of performance degrading health effects. Ingestion of low concentrations of cyanide can cause headaches, nausea, or nerve tremors. In high doses, cyanide can result in convulsions, paralysis, respiratory arrest, or death. Once a toxic level has accumulated in the blood, the cyanide exerts its effects rapidly, acting as a chemical asphyxiant. The nervous and respiratory systems are the first to fail. Typical symptoms of acute exposure to cyanide include headache, breathlessness, weakness, palpitation, nausea, giddiness, and tremors.

Lindane

4-22. Lindane is a representative pesticide used worldwide and induces a wide variety of dose-dependent symptoms when ingested in drinking water. It enters water sources from aerial spraying, runoff, or direct application for mosquito control. Wells may be contaminated with lindane when the chemical is spilled around the well during mixing operations or from prolonged exposure to repeated applications in surrounding areas. Symptoms include nausea, vomiting, frontal headache, restlessness, upper abdominal pain, diarrhea, tremors, ataxia, and reflex loss. At high doses, epileptic seizures can occur, followed by major systemic failure and even death.

Magnesium

4-23. The performance-degrading health effects stemming from elevated levels of magnesium ion above the recommended standards for field-water supplies center on the risk of dehydration caused by acute laxative action commonly known as the "runs." As the eighth most abundant element on earth, magnesium is the main contributor to water hardness. When ingested in moderate doses, magnesium acts as a laxative. The magnesium standard was established to prevent chemically induced diarrhea, which can degrade Soldier or Marine performance.

Sulfates

4-24. Similar to magnesium, the degradation of Soldier or Marine health from ingestion of sulfate ion levels above recommended standards in field-water supplies comes about through the risk of dehydration caused by acute laxative action. Sulfates occur naturally in water as the result of dissolution of sulfur-bearing minerals. Significant concentrations also result from industry sources, such as coal mine drainage, pulp paper mills, tanneries, textile mills, and domestic waste water. Sulfate is easily recognized by its distinct bad taste in water.

Hardness

4-25. Hardness is chiefly due to the carbonates and sulfates of calcium, iron, and magnesium as discussed earlier. Hardness is generally computed from the amounts of calcium and magnesium in the water and expressed as equivalent calcium carbonate.

Total Dissolved Solids (TDS)

4-26. The TDS of water is composed of mineral salts and small amounts of other inorganic and organic substances. TDS is composed of chloride, magnesium, sulfate, and other ions and its ingestion in water may result in chemically induced diarrhea. Concentrations of TDS above the recommended standards in field water quality will likely impact the health of Soldiers and Marines by degrading performance. The risk of dehydration is directly proportional to the increased levels of TDS caused by water rejection.

Microbiological Quality

4-27. The microbiological quality of potable water indicates the water's potential to transmit waterborne diseases. Diseases may be caused by viruses, bacteria, protozoa, or higher organisms. Medical personnel will conduct microbiological testing at the point of production, initially and at intervals thereafter as directed in TB MED 577 or determined by the local medical authority. Preventive medicine will also test packaged water, major water storage sites, and water provided by a host nation. Total coliform testing will be performed using the membrane filter technique, or by the defined substrate method, such as the commercially available "Colilert" and "Colisure" tests. Each lot of bottled or packaged water should be tested by veterinary personnel upon receipt at a central storage facility, warehouse, port of entry, or other theater area issue point. Water provided by a host nation or treated by host nation should comply with STANAG 2136 or other multinational agreements as applicable. TB MED 577 prescribes the procedures and standards for testing frequency and water quality.

Radiological Quality and Standards

4-28. Radiological elements may appear in water supplies as a result of naturally occurring contamination, indiscriminate disposal of hospital or industrial nuclear wastes, and from directed nuclear weapons employed in combat. These are all in addition to the deliberate effect of nuclear weapons directed at Soldiers or Marines engaged in combat on an active CBRN battlefield.

4-29. Water treatment specialists and preventive medicine personnel are responsible for measuring levels of radioactivity in bulk water supplies. Radiation has an adverse physical effect on Soldiers and Marines, causing nausea, vomiting, hair loss, and the degradation of the body's natural defenses to infections. Depending on the severity of contamination, Soldiers and Marines suffering from radiological poisoning may become combat ineffective.

Chemical Agent Standards

4-30. Chemical agent standards are established to prevent degradation of Soldier and Marine performance by low levels of agents. Additional information on chemical agents is contained in TB MED 577. The M272 kit within the WQAS-P is used to detect the chemical agents discussed below.

Hydrogen Cyanide

4-31. Hydrogen cyanide is used as a chemical agent and interferes with enzymes that facilitate the use of oxygen by cells. It is also referred to as hydrocyanic acid or prussic acid. Its effects are the same as those described for cyanide and the recommended standards to prevent performance-degrading effects are considered to be the same.

Lewisite

4-32. The active ingredient in Lewisite is Arsenic and it exists in many forms in water. Organic arsenic forms are more toxic than inorganic forms. Reports of human exposure to inorganic arsenic via ingestion include several in which the arsenic was consumed in drinking water. When exposures were high enough to cause observable health effects, several different organ systems are affected, including the circulatory, gastrointestinal, integumentary (skin), nervous, hepatic, renal, and immune systems.

Mustard

4-33. This agent causes skin blistering and blindness. If ingested, it can cause vomiting and fever as it burns the lining of the stomach and intestines. Sulfur mustard, a blistering agent, may be used in any of three formulations; distilled mustard (HD), thickened mustard (THD), or impure mixture (HT) containing 60 percent HD. All are only slightly soluble in water.

Organophosphorus (OP) Nerve Agents

4-34. Concentrations of organophosphorus (OP) nerve agents in field water greater than the recommended standards can produce performance-degrading health effects that can include abdominal cramps, vomiting, diarrhea, and headaches. A sufficiently high level consumed over the course of a 7-day period may even lead to death.

DISEASES AND DISINFECTION

4-35. Disinfection of potable water supplies reliably removes disease producing organisms from water. Leaders must instruct Soldiers and Marines not to drink unapproved water which could cause the spread of disease. Waterborne diseases and disinfection methods are described below and in TB MED 577, TC 4-02.3, *Field Hygiene and Sanitation*, ATP 4-25.12, *Unit Field Sanitation Teams*, and FM 4-02.17, *Preventive Medicine Services*.

WATERBORNE DISEASES

4-36. Water is a carrier of many organisms which cause intestinal disease. An entire unit's combat readiness can be degraded by the spread of any of many preventable diseases. An epidemic of one of these diseases among service members can be more devastating than enemy action and can cause great damage to morale as well as health. A heavy responsibility thus rests upon leaders, who must ensure that their personnel are familiar with the dangers of consuming untreated water. Water treatment specialists and the unit field sanitation team must maintain proper disinfectant residuals in potable water. The types of water treatment methods to be used when certain chlorine resistant organisms are encountered should be prescribed by the command surgeon and preventive medicine personnel who can recognize or anticipate the presence of these organisms. In addition to the native water bacteria, water usually does contain a variety of bacteria as a result of contamination from external sources. These sources include air, soil, and human and animal excreta. The number of bacteria in the air bears a close relation to the quantity of larger suspended particles or dust.

Types of Diseases

4-37. The principle diseases contracted by humans from ingesting contaminated water are diarrheal disorders due to certain *E. coli*, which produces toxins, salmonellosis, shigellosis, cholera, amebiasis, giardiasis, and several others. Infectious hepatitis and typhoid fever are non-diarrheal infections that can be waterborne. Schistosomiasis and leptospirosis, also waterborne diseases, principally occur from walking, working, or bathing in contaminated water.

Onset of Symptoms

4-38. A waterborne disease rarely produces symptoms in its victims immediately after drinking contaminated water. A period of time, known as the incubation period, must pass before the victim comes down with the disease. During this incubation period the disease organisms are growing and multiplying within the host. Therefore, an absence of symptoms for several days after drinking untreated water is no guarantee that the water is safe. The absence of disease among the local inhabitants is also no assurance of safety because they may have developed immunity.

4-39. When evaluating risk from waterborne infections, the latency period for the pathogenic microorganisms of concern generally is 1 to 3 days. This means that the expected percentage of troops that will become ill may still be capable of executing their military responsibilities for up to 1 day and maybe even for up to 3 days after ingesting field water containing any of the microorganisms of concern. TB MED 577 contains detailed information on these waterborne diseases that are of concern to the military: diarrhea, cholera, typhoid, amebiasis, giardiasis, cryptosporidiosis, shigellosis, viral hepatitis A, schistosomiasis, leptospirosis, metabolites of algae and related aquatic bacteria, and water related organisms.

DISINFECTION OF WATER

4-40. Chlorination will be used for disinfection of potable water in most cases. TB MED 577 provides detailed information on the responsibilities of preventive medicine personnel and the guidelines that are applicable to the measurement of chlorine residual in potable water. The efficiency of chlorine disinfection is affected by the following characteristics:

- Form of chlorine present, the pH of the water and the contact time.
- Type and density of organisms present and their resistance to chlorine.
- Concentration of substances other than disease-producing organisms that exert a chlorine demand.
- Adequate mixing of chlorine and chlorine demanding substances.
- Adding a sufficient amount of chlorine to produce a chlorine residual.

4-41. At the water treatment area, water treatment personnel will add sufficient chlorine to system-treated water to maintain a 2.0 milligrams per liter (mg/L) free-available chlorine (FAC) residual after a 30-minute contact time. This is the minimum level required to provide disinfection of treated water. If chlorine supplies are low and there is a need to conserve remaining supplies, the command surgeon may authorize reduced chlorine residuals. Disease-producing organisms, such as *entamoeba histolytica* and *giardia lamblia*, are

resistant to normal chlorine residuals. In areas where they are widespread, the command surgeon may require higher than normal residuals and longer contact times.

WATER TREATMENT PROCESSES

4-42. Army water treatment specialists use three treatment processes to treat water: filtration, reverse osmosis, and disinfection. The water treatment process effects the physical and chemical characteristics of water. The water treatment specialist must know how to monitor for and respond to the presence or absence of these characteristics if he is to properly operate water treatment, storage, and distribution systems.

4-43. Water treatment systems are used to achieve potability standards for drinking water. Raw water goes through initial filtration to remove large suspended solids. After initial filtration, some circumstances may require chemical pretreatment in order to increase the effectiveness of second stage filters or neutralize chlorine existing in source water. Next, water passes through second stage filtration (filter types vary with different water treatment systems) that removes micro-organisms and other suspended matter.

4-44. Another chemical injection (antiscalant/sequestrant) occurs after second stage filtration to reduce scaling and corrosion of pipes, pumps and filters. Next, water under high pressure is forced through reverse osmosis membranes to remove all remaining dissolved solids and contaminants. Finally, water is disinfected by water treatment specialists to achieve potability standards outlined in TB MED 577. Purified water is chemically disinfected using calcium hypochlorite to neutralize any remaining pathogens and provide residual disinfectant in storage and distribution systems, which protects against future contaminants. Figure 4-1 is a flow chart of the basic water treatment process.

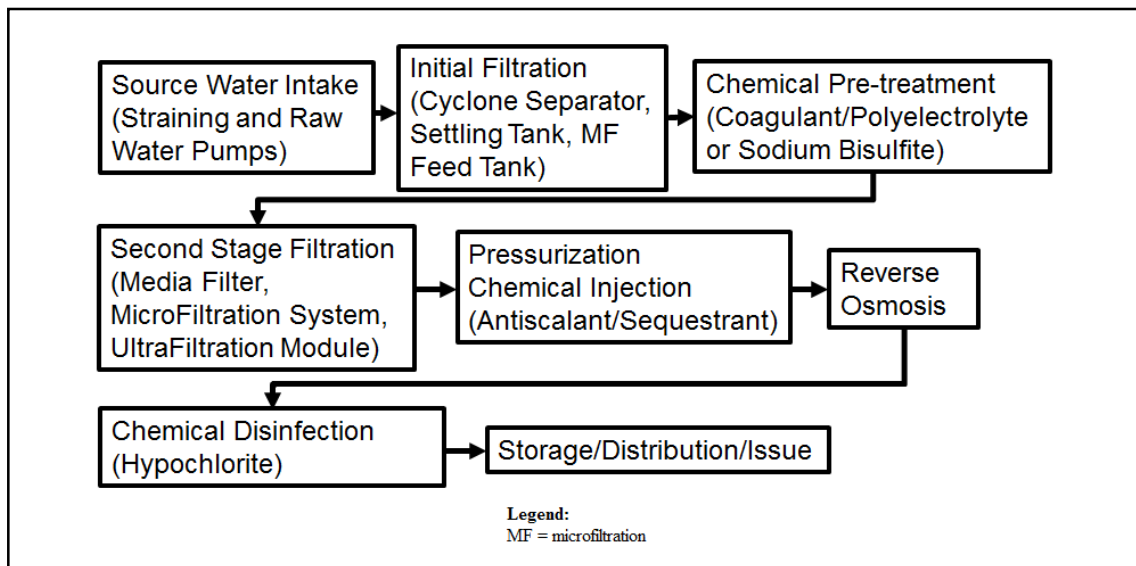

Figure 4-1. Water treatment flow chart

FILTRATION

4-45. The filtration process removes suspended solids including silt, dirt, small particles, microorganisms, algae, plant and animal products prior to reverse osmosis. The removal of these suspended solids is essential, as the feed-water for reverse osmosis must be as free from suspended solids as possible. Individual water treatment systems use different types of strainers, tanks, and filters to achieve first and second stage filtration. While each system uses a different filtration process, the outcome will remain the same. The following is an overview of the two stages of filtration.

Initial Stage Filtration

4-46. The initial filtration stage removes large suspended solids and debris from raw water which can damage water treatment systems components. The following types of strainers are used in the initial filtration stage prior to feed water entering main components of water treatment systems:

- Floating inlet strainers (all water treatment systems) are used to hold the raw water intake hose off the bottom of the water source and screens out leaves, sticks, fish and other large objects.
- Settling tanks (LWP) receive raw water from the floating inlet strainer, which is then filtered through an additional floating strainer inside the settling tank. This allows suspended solids to settle at the bottom of the tank. Feed water is then pulled from the top of the tank into the water treatment system.
- Microfiltration feed tanks (TWPS) receive raw water from the floating inlet strainer, which is then pumped through a cloth mesh filter bag that fits inside the microfiltration feed tank. Feed water is then pulled from below the filter bag into the water treatment system.
- The cyclone separator (TWPS and ROWPU) receives raw water from the floating inlet strainer, and then uses centrifugal water flow action to remove sand and heavy dirt from the raw water. When used in conjunction with a microfiltration feed tank, a cyclone separator is placed between the floating inlet strainer and the microfiltration feed tank.
- Basket strainers (TWPS and ROWPU) catch any remaining suspended solids that leaked through earlier stages of initial filtration in order to prevent damage to water treatment systems.

Second Stage Filtration

4-47. Second stage filtration removes suspended solids prior to reverse osmosis. This stage of filtration is focused on the removal of turbidity and smaller suspended solids including micro-organisms and bacteria.

Ultrafiltration

4-48. Ultrafiltration is used in the LWP system. The ultrafiltration process uses a ultrafiltration membrane cartridge to filter water prior to reverse osmosis. It is accomplished by means of three ultrafiltration cartridges that can filter suspended particles, bacteria and microorganisms. The ultrafiltration membranes offer the advantage of prolonged reverse osmosis membrane life due to micron size removal (regardless of the feed water conditions) and elimination of disposable filters.

Microfiltration

4-49. Microfiltration is used in the TWPS. Each filter module contains a filter element that is composed of a bundle of hollow, porous fibers. Microfiltration feed water enters the microfiltration assembly, passes through the porous wall of each fiber and exits the hollow core of each fiber as filtrate (filtered feed water). The suspended solids and microorganisms that accumulate on the fibers are removed from the fibers during regular automatic backwashes.

Multimedia and Cartridge Filtration

4-50. Multimedia filters are used in the ROWPU. Water enters the top of the filter through the upper distribution, flows downward through one layer of coarse aggregate filter media, and a final layer of very fine garnet sand. These layers are all supported by three layers of support gravel. A collector picks up the filtered water for discharge. If the suspended solids are too small to be removed by the straining action of the filter media, a coagulant (polyelectrolyte) can be added to the feed water to group suspended solids for more effective removal. With the aid of this chemical, the filter can remove most suspended solids from water resulting in a turbidity level within treatment parameters. Water exiting the multimedia filter is then processed by a cartridge filter, which further removes suspended solids prior to the reverse osmosis process.

REVERSE OSMOSIS

4-51. Reverse osmosis is a purification process in which filtered water is pumped against a semipermeable membrane under great pressure. The membrane allows product water to pass through while rejecting the

impurities, both suspended and dissolved. Extremely high pressure is used to get a proper volume of water passing through a unit area of membrane. The reverse osmosis process is illustrated in figure 4-2 on page 4-10.

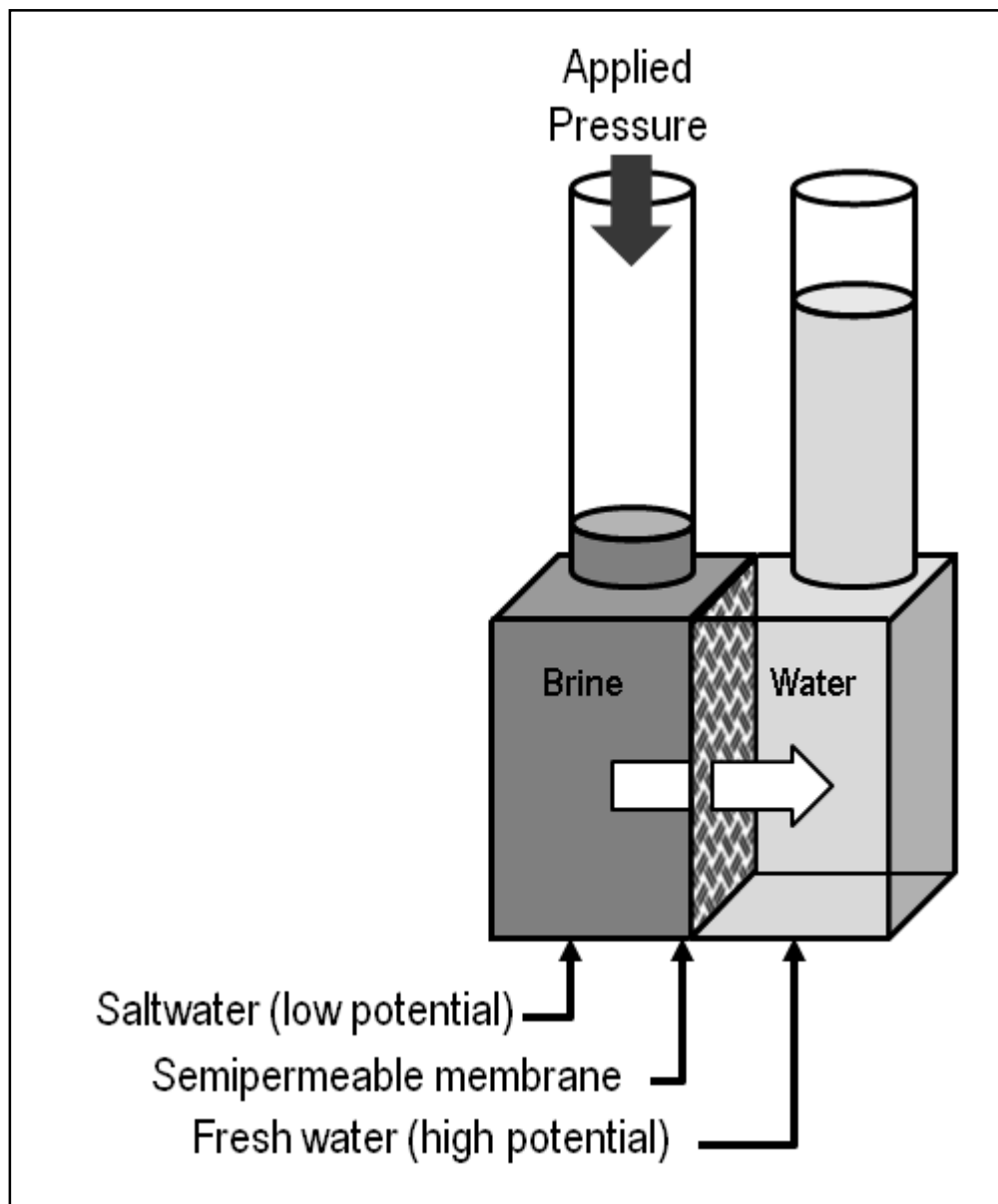

Figure 4-2. Reverse osmosis process

4-52. Although reverse osmosis can appear to be similar to a filtration process, there are distinct differences. In filtration, the entire liquid stream flows through the porous filter medium, and there are no changes in chemical potential between the feed and filtrate. In reverse osmosis, the feed flows parallel to the semipermeable membrane with a fraction of it passing through a given membrane area; dissolved ionic and organic solutes are largely rejected by the membrane. Reverse osmosis removes selenium, copper, iron, manganese, chloride, lindane, radiation, and most color and odor causing compounds.

4-53. A reverse osmosis element is composed of sheets of membranes in a spirally wound tube, see figure 4-3. Mesh spacers are inserted between layers of the membrane to allow water to flow into and out of the element. See figure 4-4 for a cut away view of a partially unwound element. The center of the element is a plastic tube with small holes for the collection of product water. The leaves of membranes and spacers are

rolled around the product water collection tube in the center of the element. The structure of the reverse osmosis element allows water to flow from one end of the element to the other without any water passing through the membrane until the osmotic pressure is overcome. When the water has a low osmotic pressure, it flows through the elements and out the brine channel, but not into the product line. Under a lower than osmotic pressure condition, the elements, and consequently the membrane, are doing no work. The water just passes by the membrane rather than through it, so water does not collect in the product water collection tube.

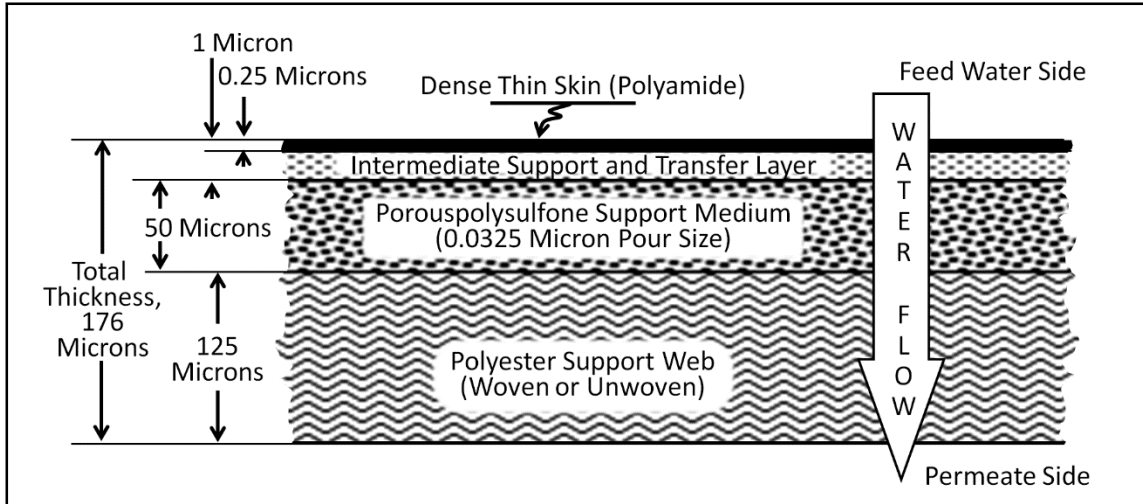

Figure 4-3. Reverse osmosis membrane composition

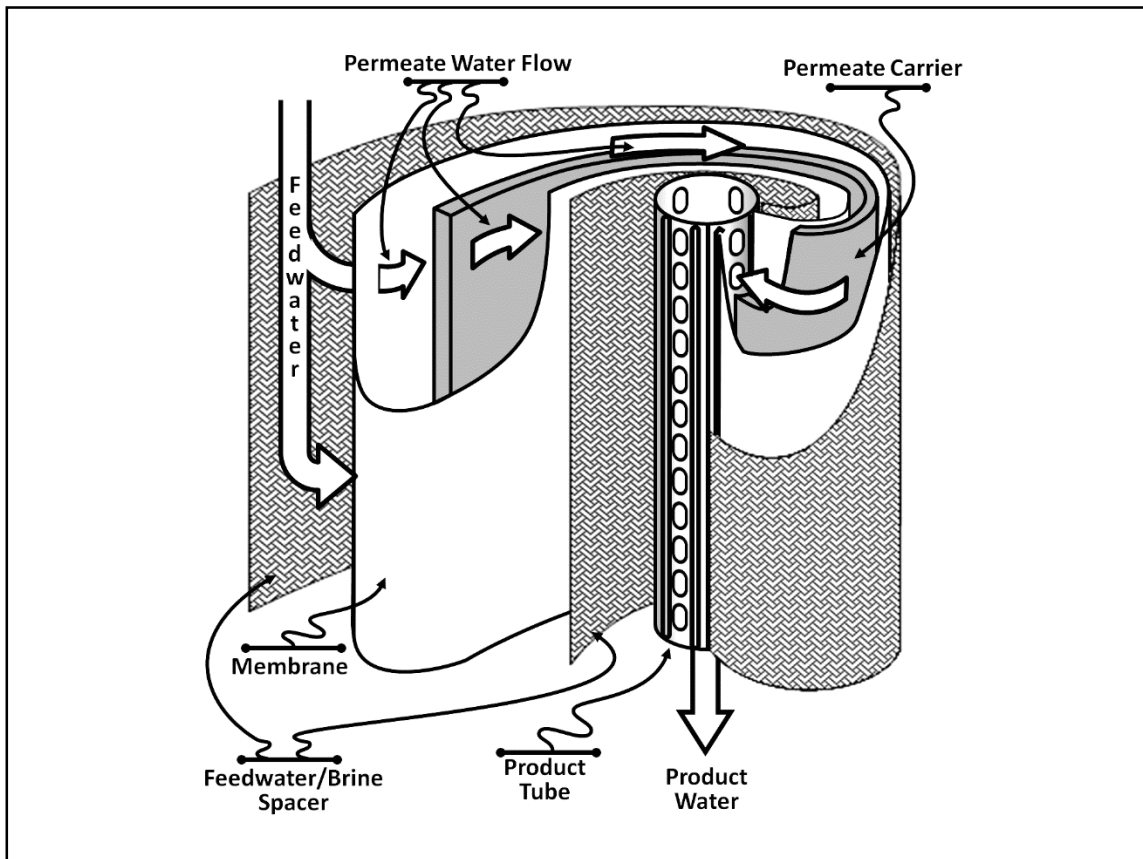

Figure 4-4. Spirally wound reverse osmosis membrane assembly

4-54. When the reverse osmosis element is operating normally (at feed pressures in excess of the osmotic pressure), the concentrated brine (waste) stream flows out through the feed water spaces. The brine collects at the end of the last element and flows out of the pressure vessel. Product water passes through the membrane into the product water channel from both sides. The product water entering the mesh from the membrane flows spirally towards the central product water collection tube. At the very center of the element, the product water channel butts up against the holes in the product water collection tube. Water passes from the product water channel into the product water collection tube, and then flows out of the pressure vessels and finally into the product water piping.

4-55. Feed water does not seep into the product water channel because three sides of the leaf of two membrane sheets and the product water channel mesh are glued together. Two of the glued sides become the ends of the element. This isolates the product water channel from feed water on one end of the element and brine on the opposite end. The third side becomes a seam, which stops feed water from reaching the product water channel without passing through the membrane. The mesh must protrude from this membrane sandwich on the remaining side so that it can butt up against the product water collection tube. Because of this arrangement, only water that has passed through the membrane can enter the product water channel mesh.

4-56. The wagon wheel-shaped plastic stems, which extend from the central product water collection tube to the outside perimeter of the element, are called antitelescoping devices. These stems form a frame, which prevents telescoping of the membrane. Telescoping describes the condition when the feed water spacer begins to extend beyond the membrane leaves at the ends of the element. Excessively high pressure operation of the reverse osmosis purifier could lead to telescoping if not for these devices.

Membrane Fouling and Treatment

4-57. It is imperative to have a thorough understanding of what causes an increase of pressure in reverse osmosis systems and how to reliably monitor and maintain reverse osmosis system performance. Membrane fouling occurs in nearly all reverse osmosis systems and all membranes lose their performance quality over time. The frequency of fouling varies from one reverse osmosis unit to the next, and depends on a number of variables including system recovery rate, reverse osmosis feed water characteristics, and pretreatment. Understanding the basic principles of membrane fouling helps operators more effectively prevent premature fouling.

Types of Foulants

4-58. Reverse osmosis membranes can be fouled and clogged by bacterial slimes, hard water scale, iron, and silt. The concentrations of the dissolved and suspended solids on the membrane surface affect the performance of the membrane. Higher concentrations mean higher osmotic pressure, which results in a higher tendency for suspended solids to cluster and coat the membrane surface, and higher likelihood of scaling to take place. The following are four categories of membrane foulants which can be classified by physical type and location on the membrane.

- Dissolved solids are scale-forming materials such as calcium and barium, which are soluble in feed water. They are either cations (positively charged ions) or anions (negatively charged ions), which may complex and precipitate in the brine stream as their concentrations increase in reverse osmosis. Examples of precipitated cation or anion compounds include calcium carbonate, calcium sulfate, barium sulfate, and strontium sulfate.
- Suspended solids maintain their suspension through a process of repulsion by a double layer of charge. Examples of suspended solids include colloidal forms of metal oxides such as iron, aluminum or silica. Suspended solids can stabilize particulates such as carbon fines which may inadvertently leak during second stage filtration. Suspended solids tend to cluster and settle onto the membrane surface when concentrated past the point of their charge related stability.
- Biological foulants are aerobic and anaerobic living materials such as bacteria, fungus, algae, and the metabolic waste they generate. Such foulants tend to be present in low concentrations and literally grow into massive quantities that effectively block flow through the membrane surface.
- Non-biological organic foulants are substances that contain carbon-based chemical structures, but which are not living organisms. Examples of non-biological organic foulants are materials such as oil, plant materials, cationic surfactants, and hydrocarbons.

Foulant Location

4-59. Fouling occurs at various locations within the reverse osmosis system and is directly due to the type of foulant. Generally speaking, colloidal fouling will start at the first element in the first pressure vessel where it collects the small particles that escape the pretreatment system. Because of the higher concentration of dissolved solids, scaling will start in the end element in the last pressure vessel and work its way forward. Biological fouling should occur throughout the system.

Prevention and Pretreatment

4-60. Proper pretreatment produces reverse osmosis feed water of an acceptable quality and minimizes the particles that may carry over to the reverse osmosis membranes. Membrane life is a function of feed water source, pretreatment, frequency of cleaning, and operating conditions. Ineffective or unreliable pretreatment can adversely affect the reverse osmosis system with problems such as high rates of membrane fouling, excessive cleaning requirements, lower recovery rates, high operating pressure, reduced membrane life, and poor quality product water. Each of these factors contributes to higher operational costs and lower productivity. Operators and supervisors must understand reverse osmosis fouling prevention and pretreatment in order to maximize membrane life and water production. An efficient operation should yield a five year life span for membranes.

Chemical Treatment

4-61. Ensure operators are properly using chemicals when required. For systems with a multimedia filter, coagulant must be added to the influent stream before it reaches the filter and periodically adjusted to optimize the polymer's effectiveness. **An influent is water flowing into a reservoir, basin, or treatment operation.** This will flocculate the colloidal material and provide consistent removal of solids in the multimedia filter. It will also provide a quality feed to the cartridge filter which removes the smaller particles. As these filters become clogged, they will have to be serviced. The desired turbidity of the membrane feed water is one nephelometric turbidity unit or less. Systems utilizing ultrafiltration (LWP) and microfiltration (TWPS) usually do not require the use of a coagulant because of their ability to remove most particles and microorganisms. For the LWP, the use of a coagulant is required if raw water turbidity is greater than 150 nephelometric turbidity units.

4-62. Antiscalants must be used to solubilize or disperse foulants and scale forming compounds. Sodium hexametaphosphate is an antiscalant and should be used to inhibit the formation of scale forming compounds. It is injected in the raw water to prevent scaling of the system caused by calcium carbonate. Citric acid can be used to dissolve calcium carbonate. It is injected to prevent calcium carbonate deposits that may build on the reverse osmosis elements by maintaining a lower pH in the feed water.

Rinses and Preservations

4-63. Supervisors must stress the importance of performing rinses and preservations. If water treatment operations are interrupted or periodically shut down, membranes should be rinsed with permeate water. The objective is to minimize the concentration of salts in membranes while there is no flow.

4-64. Particulate foulants should also be rinsed before shutdown or they may also settle onto the membrane surface and result in severe and often irreversibly fouled membranes. If the membranes are expected to remain idle for a longer period of time, an appropriate preservative should be used to inhibit biological growth. Bacteria can grow through reverse osmosis membranes leading to bacteria growth in post-filter areas.

Reverse Osmosis Cleaning Tips

4-65. The fouling or scaling of elements typically consists of a combination of foulants and scalants. Therefore, it is very critical that the first cleaning step is wisely chosen. Membrane manufacturers typically recommend alkaline cleaning as the first cleaning step. Acid cleaning should only be applied as the first cleaning step if it is known that only scaling is present on the membrane elements. Acid cleaners typically react with silica, organics and biofilm present on the membrane surface which may cause a further decline in membrane performance. Sometimes, an alkaline cleaning may restore this decline that was caused by the acid cleaner, but often an extreme cleaning will be necessary. If the reverse osmosis system suffers from

colloidal, organic fouling or biofouling in combination with scaling, then a two-step cleaning program will be required consisting of a high pH alkaline cleaning followed by a low pH acid cleaning. The acid cleaning may be performed when the alkaline cleaning has effectively removed the organic fouling, colloidal fouling and biofouling. Refer to the water treatment system's technical manual for specific cleaning procedures.

DISINFECTION

4-66. Disinfection is a water treatment process in which pathogenic (disease producing) organisms are killed, destroyed, or otherwise inactivated (TB MED 577). Disinfection is usually the last process and final treatment barrier to micro-biological contaminants in water treatment systems. Disinfection involves exposing the water to an oxidant for a specific period of time to kill or inactivate pathogenic micro-organisms that were not removed by the preceding treatment processes. The disinfectant may also oxidize certain chemical contaminants that passed through the previous treatment steps. A secondary purpose for disinfecting military drinking water is to provide a measurable disinfectant residual in storage and distribution systems as a sentinel to post treatment contamination and to prevent and minimize bio-film growth.

4-67. Water must be disinfected to be considered potable. No other treatment process, or combination of processes, will reliably remove all disease-producing organisms from water. All methods of disinfection must satisfy the following criteria. The disinfectant should:

- Mix uniformly to provide intimate contact with potentially present microbial populations.
- Have a wide range of effectiveness to account for the expected changes in the conditions of treatment or in the characteristics of the water being treated.
- Not be toxic to humans at the concentration levels present in the finished water.
- Have a residual action sufficient to protect the distribution systems from micro-biological growths and act as an indicator of recontamination after initial disinfection.
- Be readily measurable in water in the concentrations expected to be effective for disinfection.
- Destroy virtually all micro-organisms.
- Be practical to use and maintain.

Chlorine

4-68. Chlorine is the disinfectant agent usually specified for military use. Presently, this is the only widely accepted agent that destroys organisms in water; it leaves an easily detectable residual that serves as a trace element. Sudden disappearance of chlorine residual signals there is a potential contamination in the system. No other available disinfectant is as acceptable or adaptable for potable water treatment operations as chlorine. A major disadvantage is that chlorine reacts with certain organic compounds to form trihalomethanes, a known carcinogen.

4-69. The most important variables in the effectiveness of chlorine disinfection of drinking water are the chlorine dose, demand, residual concentration, and contact time after the demand has been exceeded. The chlorine dose is the amount of chlorine added per unit volume of water and is usually expressed in parts per million or its equivalent milligrams per liter. The chlorine demand is the amount of chlorine per liter of water that reacts with inorganic and organic matter, including micro-organisms, and is no longer available for disinfection. After the demand is completely satisfied, any remaining chlorine will be free chlorine that is available to be measured as a residual. The residual chlorine will react with any contaminants that subsequently get into the water as well as prevent regrowth of inactivated bacteria in any storage and distribution system that may be in use.

4-70. There are two types of hypochlorite (dry and liquid). These are explained below:

- Dry hypochlorites added to water form hypochlorite solutions containing an excess of alkaline material, which tend to increase the pH. If the pH of the hypochlorite and water mixture rises high enough, calcium in the water and in calcium hypochlorite precipitates as calcium carbonate sludge. Precipitate is to separate from solution or suspension. If this occurs, allow the hypochlorite and water mixture to stand so that the calcium carbonate may settle out. After the liquid hypochlorite solution settles, decant it into a separate tank for use. Dry hypochlorites use calcium hypochlorite and lithium hypochlorite. High-test hypochlorite products contain about 70 percent available

chlorine and 3 to 5 percent limes. Calcium hypochlorite is available in granular, powdered, or tablet forms and is readily soluble in water. Ship granular and tablet forms in 35 or 100 pound drums, cases, or smaller reusable cans. This is the form of chlorine found most often in Army water treatment operations. Lithium hypochlorite contains about 35 percent available chlorine, readily dissolves in water, and does not raise the pH as much as other hypochlorite forms. Lithium hypochlorite is available in granular form. It is generally used for disinfecting swimming pools.

- The liquid solutions are clear; light yellow, strongly alkaline, and corrosive. They are shipped in plastic jugs, carboys, and rubber-lined drums of up to 50 gallon volumes. Sodium hypochlorite is available commercially in liquid form, such as Clorox. Household bleach is a sodium hypochlorite solution containing about 5 percent available chlorine. The usual concentration of sodium hypochlorite is between 5 and 15 percent available chlorine.

4-71. High-test hypochlorites are relatively stable during storage. Storage at temperatures below 86°F reduces the rate of deterioration. Unlike calcium hypochlorite, which can be stored for up to a year, sodium hypochlorite solution has a shelf life of only 60 to 90 days. Store sodium hypochlorite solutions in dry, cool, and darkened areas or in containers protected from light. Store hypochlorite solutions in rubber lined or polyvinyl chloride lined steel tanks fed through fiberglass, saran lined, or polyvinyl chloride piping. Do not store or use dry hypochlorite in the presence of oil because of the fire potential.

Ozone

4-72. The ozone is an unstable form of oxygen that kills organisms faster than chlorine. Ozone, as a disinfection agent, is less influenced by pH and water temperature than chlorine. Another advantage of ozone is that it does not form compounds that create or intensify odors in the water. The main disadvantage of ozone is that it provides no lasting residual disinfecting action. In addition, because of its instability, ozone is usually generated at the point of use. The process is not as adaptable to variations in flow rate and water quality as chlorine.

Chlorine Dioxide

4-73. Chlorine dioxide is a red-yellow gas or liquid with a very irritating odor. It has over two and half times the oxidation capacity of chlorine; but its rate of reaction is slower, and the mechanism of disinfection is completely different. It is effective over a broad pH range (5 to 9) and is not affected by sunlight. A major advantage of chlorine dioxide is that it does not hydrolyze in water and will not react with organic compounds to form trihalomethanes.

Chlorination Effectiveness

4-74. Chlorination is the treatment of water by the addition of chlorine either as a gas or liquid, or in the form of hypochlorite, usually for the purpose of disinfection or oxidation. Use chlorination to disinfect potable water in most cases. The efficiency of chlorine disinfection is affected by the following variables.

4-75. As the pH of the water increases from five to nine, the form of the chlorine residual changes from hypo-chlorous acid to hypochlorite ion, which is less effective. The most effective disinfection occurs when the pH is between 5.5 and 6.5. At the same pH, a longer contact time also results in increased disinfection. Contact time is the time elapsing between the introduction of the chlorine and the use of the water. The required contact time is inversely proportional to residual, within normal limits. If the residual is halved, the required contact period is doubled. Army standards specify a minimum of 30 minutes contact time before product water is tested for residual to determine potability. A free available chlorine residual of two parts per million must be maintained for water to be potable after the 30 minute contact time.

4-76. The type and density of organisms present (virus, bacteria, protozoa, helminths, or other) and their resistance to chlorine. Bacteria are most susceptible to chlorine disinfection whereas the cysts of the protozoa *entamoeba histolytica* and *giardia lamblia* are the most resistant.

4-77. At lower temperatures, the micro-organism kill rate tends to be slower needing higher chlorine residuals or longer contact times. Disinfection efficiency increases in warm water. Longer contact time or increased chlorine dosage is required when the water temperature is low. Effectiveness of free chlorine at 35° Fahrenheit is about half of that at 70° Fahrenheit.

4-78. During disinfection, chemical compounds such as those containing ammonia and organic material can exert chlorine demand. When these reactions occur, the chlorine is not available for disinfection. Chlorine demand is chlorine required to react with chlorine destroying compounds. Disinfection cannot begin until chlorine demand has been satisfied. Some of the compounds in water that exert a chlorine demand include iron, manganese, hydrogen sulfide, ammonia, and miscellaneous organic compounds. Add sufficient chlorine to the water supply to satisfy the chlorine demand, in addition to the amount required for actual disinfection.

4-79. Adequate mixing of chlorine and chlorine demanding substances is important because suspended solids can surround and protect organisms from the disinfectant. Thoroughly mix the disinfecting agent to ensure that all disease-producing organisms come in contact with the chlorine for the required contact time.

Chlorination Treatment

4-80. Combined residual chlorination involves applying chlorine to water to produce combined available chlorine residual and to maintain that residual through the water treatment and distribution operations. Combined available chlorine forms are less effective as disinfectants than free available chlorine forms. About 25 times as much combined available residual chlorine is needed to obtain equivalent bacterial kills as required for free available residual chlorine under the same conditions of pH, temperature, and contact time. About 100 times longer contact time is needed to obtain bacterial kills for equal amounts of combined versus free available chlorine residuals under similar conditions. Use combined residual chlorination to control algae and bacterial after growth in potable water distribution systems. Combined chlorine residuals can maintain a stable residual throughout the system to the point of usage at the distribution point. In some cases, use free residual chlorination to ensure effective disinfection, followed by the addition of ammonia to convert the free residual to a combined available residual.

Free Residual Chlorination

4-81. Free residual chlorination involves producing a free available chlorine residual through part or all of the water treatment and distribution operations. Free available chlorine is the equilibrium products present in the forms of hypo-chlorous acid or hypochlorite ions. Form free available chlorine residuals by applying chlorine to water, if the water contains no ammonia or other nitrogenous materials. If the water contains ammonia and combined available chlorine residuals are formed, add sufficient chlorine to destroy the combined chlorine residual. Free residual chlorination provides initial disinfection with a contact period of about 10 minutes, whereas combined chlorine residual requires at least 60 minutes. Changes in pH and temperature will impact free chlorine efficacy. Combined chlorine residual must be increased significantly with increases in pH and decreases in temperature. Diminish taste and odors by using free residual.

Breakpoint Chlorination

4-82. ***Breakpoint chlorination is the application of chlorine to water containing free ammonia.*** Adding chlorine to water with ammonia forms chloramines. Chloramines (chemistry/elements and compounds) are an unstable colorless liquid with a pungent odor, made by the reaction of sodium hypochlorite and ammonia. With additional application, chlorine residuals increase and reach a maximum when the ratio of chlorine to ammonia is equal. As greater dosages of chlorine are applied and the ratio of chlorine to ammonia increases, ammonia oxidizes by the chlorine to reduce the chlorine residual. When approximately 10 milligrams per liter of chlorine is added for each milligram per liter of ammonia present, chlorine residuals decline to a minimum value. This is the breakpoint and represents a point where further addition of chlorine produces a free residual (see figure 4-5). The actual amount of chlorine required to arrive at the breakpoint varies between seven and 15 times the ammonia nitrogen content of the water. Due to the presence of organic and other chlorine reactive materials, use up to 25 times as much chlorine as ammonia nitrogen to reach breakpoint. Beyond the breakpoint, the residual should have at least 90 percent free available residual chlorine. The rate of the breakpoint reaction appears to be most rapid between a pH of seven and eight, and it increases with a higher temperature. Nitrogen trichloride forms after the breakpoint treatment if pH levels are below eight, imparts odors to the water. Expose the water to air to provide for the release of nitrogen trichloride. Suspended solids can surround and protect organisms from the disinfectant.

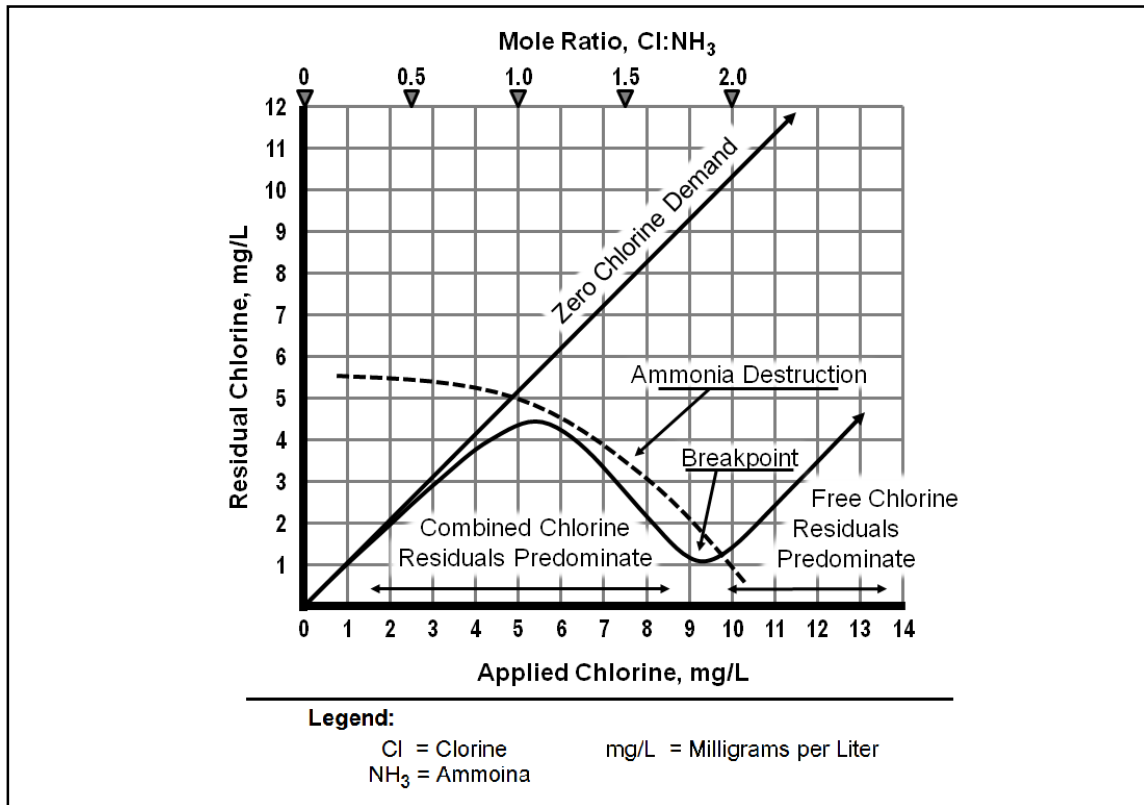

Figure 4-5. Breakpoint chlorination chart

SECTION II – OPERATOR WATER TREATMENT PLANNING

4-83. This section will discuss planning considerations for water treatment system operators. Water treatment system operators must forecast petroleum and chemical requirements to ensure continuous operations. Reports must be maintained to capture historical data and calculate accurate supply forecasts. Operators must also plan for extreme weather, CBRN decontamination, safety, and environmental stewardship. Appendix C provides formulas and conversions that are commonly used during water support operations.

PETROLEUM REQUIREMENTS

4-84. The number of pieces of fuel-consuming equipment at each water site must be known to determine petroleum needs. The tempo and stage of operations will also impact fuel consumption. The most accurate method of estimating fuel, oil and lubricant requirements is based on unit historical data which reflects the variables of weather, terrain, organizational strength, and operational vehicles and equipment. When historical data is unavailable, operators can use the equipment TM and data plate to assist in determining fuel, oil, and lubricant capacities and consumption rates. Water treatment specialists are responsible for estimating petroleum needs and submitting them to the supply sergeant in a timely manner.

4-85. Water treatment specialists should deploy with enough expendables such as oil, lubricants, fuel filters, and oil filters to sustain operations until resupply can take place. If conducting long term operations consider using 55-gallon drums to store fuel. Most generators have an auxiliary connection that can accommodate the auxiliary hose assembly that connects to the 55-gallon drum fuel assembly adapter. This information is usually found in the generator TM.

CHEMICAL REQUIREMENTS

4-86. When deploying a water treatment system, water treatment specialists typically take enough chemicals to last at least 30 days, based on 20 hours of operation per day (amount of chemicals could be much higher based on mission analysis). Estimating the amount of chemicals required for an operation is a lot more complicated than estimating petroleum consumption. The chemical requirement for an operation is dependent on several variables that water treatment specialists should be aware of. These variables include:

- Source water temperature.
- Source water physical and chemical properties.
- Type of water treatment system.
- Estimated hours of operation.
- Quality of water treatment system maintenance.

4-87. Analyzing historical chemical consumption is the most accurate method of determining resupply rates and initial supply quantities. Operators can also use the equipment TM and the potable water planning guide (discussed in chapter two) to estimate chemical requirements. The TM will provide consumption estimates as well as requirements for individual system cleaning, system preservation, and base and batch charges that will help determine accurate forecasts. The potable water planning guide provides additional information on determining chemical consumption requirements. Water treatment specialists are responsible for estimating chemical requirements and submitting them to the supply sergeant in a timely manner.

WATER TREATMENT REPORTS

4-88. Daily water production logs are critical because they capture historical information that is used to schedule future resupply of fuel, oil, lubricants, and treatment chemicals. In addition, the log is used to schedule maintenance services. For this reason, data entered on production logs should be complete and accurate. DA Form 1713 (Daily Water Production Log – ROWPU), DA Form 1713-2 (Daily Water Production Log – TWPS), and DA Form 1713-3 (Daily Water Production Log – LWP) are used to record data on each individual ROWPU, TWPS, or LWP respectively. DA Form 1716 (Water Point Daily Production Summary) is used to compile all production data into a daily summary.

EXTREME WEATHER CONSIDERATIONS

4-89. Extreme weather conditions cause increased wear on water treatment systems. Extreme hot and cold weather can also prevent operation (see above-mentioned individual system descriptions for operating temperature range). Extreme hot weather environments can be arid with heavy dust, sand, and wind. Water treatment systems may require increased service timelines. Lubrication is critical to prevent abrasion of parts from dust and sand. Electrical wire insulation can wear down from sand and grit. Wires should be protected with electrical tape and inspected routinely.

4-90. Water increases in viscosity in extreme cold weather, and therefore moves slower through pumps. Disinfection chemicals require additional time to be effective in freezing temperatures. Water flow through treatment systems must be slowed to account for increased time for chemical reactions. For these reasons, production rates of water treatment systems will be reduced during cold weather operations. Extreme cold weather may cause parts to crack, especially if made of plastic. Electronic instruments may become less dependable and even fail. A winterization kit (custom component of all water treatment systems) is required when operating in freezing temperatures, and when expecting to operate in freezing temperatures. All systems components should be drained when not in use to prevent freezing. The LWP requires an additional generator and tent for operation in freezing temperatures.

CHEMICAL BIOLOGICAL RADIOLOGICAL NUCLEAR (CBRN) CAPABILITY

4-91. Water treatment systems can decontaminate raw water which contains CBRN agents. The feed water filters and the reverse osmosis elements remove most CBRN agents, however, safe levels are not assured without the use of a CBRN filter. When decontaminating raw water during CBRN missions, the product

water is additionally passed through a CBRN filter for final agent removal. CBRN filters are configured differently for each water treatment system. See separate equipment TM for specific CBRN filter specifications and service life.

WATER TREATMENT SAFETY

4-92. Operators should review the system TM to understand all safety hazards unique to each water treatment system. The following list includes some general safety precautions to observe when operating water treatment systems:

- Properly ground the water treatment system. If the generator is separated from the system, ground it also. The grounding rod should be 8 feet down and one foot up.
- Properly block wheels for trailer mounted systems.
- Serviceable fire extinguishers must be on site and a fire point established.
- All system support legs must be down and in the locked position.
- Operators will wear hearing protection when equipment is in operation.
- Post no smoking signs near fuel points and operational areas.
- Do not store chemicals under direct sunlight and always use aprons, gloves, and goggles when handling chemicals.

ENVIRONMENTAL STEWARDSHIP MEASURES

4-93. Water treatment specialists handle hazardous chemicals and generate hazardous waste when conducting water treatment operations, which can negatively impact Soldier and Marine health and the environment if not managed with care. Chapter two, paragraph 2-50 presents environmental planning considerations. The water treatment area should be designed to reduce health risks and prevent pollution whenever possible. Water units and water treatment specialists must make every effort to adhere to the following stewardship principles:

- Apply risk management procedures.
- Comply with local laws and Army (or Marine Corps) policy.
- Maintain a clean and safe work area.
- Properly store chemicals.
- Use required safety equipment when handling hazardous materials and waste.
- Report spills and other violations.
- Turn in hazardous substances.
- Conserve resources.

4-94. Wastewater from water treatment systems can be categorized as brine wastewater, filter backwash wastewater, and membrane cleaning wastewater. Each type of wastewater carries different treatment bi-products, and therefore pose different individual risks to the environment. Water treatment personnel must consider local environmental laws and regulations when executing water support operations. Typically, the theater command will issue environmental compliance guidelines. The pace of tactical operations (depending on the type or stage of an operation) may limit a unit's ability to adhere to local laws and regulations. Water treatment specialists have a responsibility to advise the chain of command when unit actions do not comply with environmental guidelines. In addition, hazardous material and hazardous waste spills should be reported immediately so that contaminated sites are restored as quickly as possible.

SECTION III – WATER TREATMENT SYSTEMS

4-95. There are three types of water treatment systems organic to Army units. The three systems include the Lightweight Water Purifier (LWP), the Tactical Water Purification System (TWPS), and the Reverse Osmosis Water Purification Unit (ROWPU). While each system uses reverse osmosis technology, they are all configured in a different way, with dissimilar production capabilities and components. There are two types of water treatment systems organic to Marine Corps units. These systems are the lightweight water purification system (LWPS) and the tactical water purification system (TWPS). The Marine Corps systems

are configured differently than Army systems, and are described separately under the Marine Corps Water Treatment Systems heading below. For detailed information on system specifications and maintenance requirements refer to the system technical manual.

125 GALLONS PER HOUR (GPH) LIGHTWEIGHT WATER PURIFIER (LWP)

4-96. The LWP gives quartermaster units the ability to produce a safe, reliable supply of potable water to support early entry, highly mobile forces across a spectrum of missions, entailing everything from humanitarian aid, limited conflicts, or total war. The LWP provides quality water support to small units and detachments where distribution of bulk water is not feasible, necessary, or practical. The LWP provides water support without committing larger water production assets from the logistics support structure. It tailors water production flow rates to the demands of independent special operations forces, detachments, and units typically engaged in remote site missions. The system includes a potable water dispensing capability that interfaces with military fixed holding tanks. The LWP can purify water from all water classifications, to include CBRN contaminated water. Figure 4-6 displays a picture of an operational LWP.



Figure 4-6. Lightweight Water Purifier (LWP)

LWP Characteristics, Capabilities and Features

4-97. The following are characteristics, capabilities and features of the LWP:

- Positioned no greater than 50 feet from raw water source.
- Area requirement is 75 feet by 75 feet.
- Produces 125 gallons per hour (GPH) from freshwater and 75 GPH from saltwater (temperature dependent).
- Utilizes ultra-filtration and reverse osmosis technology to produce potable water from virtually any raw water source.
- Equipment can be transported in a high mobility multipurpose wheeled vehicle or triple container to the operational site. It can be sling-loaded by helicopter or transported in fixed wing aircraft.
- Equipment can be unloaded with four to six personnel, set-up with two personnel, and operated with at least two personnel.
- Designed for operation between -25° Fahrenheit (F) (-32° Celsius (C)) and 120° F (49°C). At freezing temperatures, a cold weather kit is necessary. At temperatures higher than 120° F the LWP may not function properly due to possible decrease in power output from the 3 kilowatt tactical quiet generator.

LWP Major Components

4-98. The following are major components of the LWP:

- One 1,000 gallon product tank.
- One 1,000 gallon settling tank.
- 3 kilowatt tactical quiet generator set.
- LWP ultra filtration module.
- LWP high-pressure pump module.
- LWP control module.
- Reverse osmosis element module.
- LWP chemical injection/cleaning module.
- One triple container used for transport and storage.
- Cold weather kit (additional heated tent required).
- Three CBRN filters.

1,500 GPH TACTICAL WATER PURIFICATION SYSTEM (TWPS)

4-99. The TWPS is a fully contained mobile water purification system capable of purifying, storing and dispensing water meeting military field water standards for long term consumption. The TWPS is intended to supply potable water to ground, amphibious and air-mobile units of the U.S. Army and Marine Corps. It can also be used to provide potable water support to civilian agencies or host nations for emergencies, disaster relief, humanitarian efforts and peacekeeping missions. The TWPS can purify water from all water classifications, to include CBRN contaminated water. Figure 4-7 displays a picture of an operational TWPS.

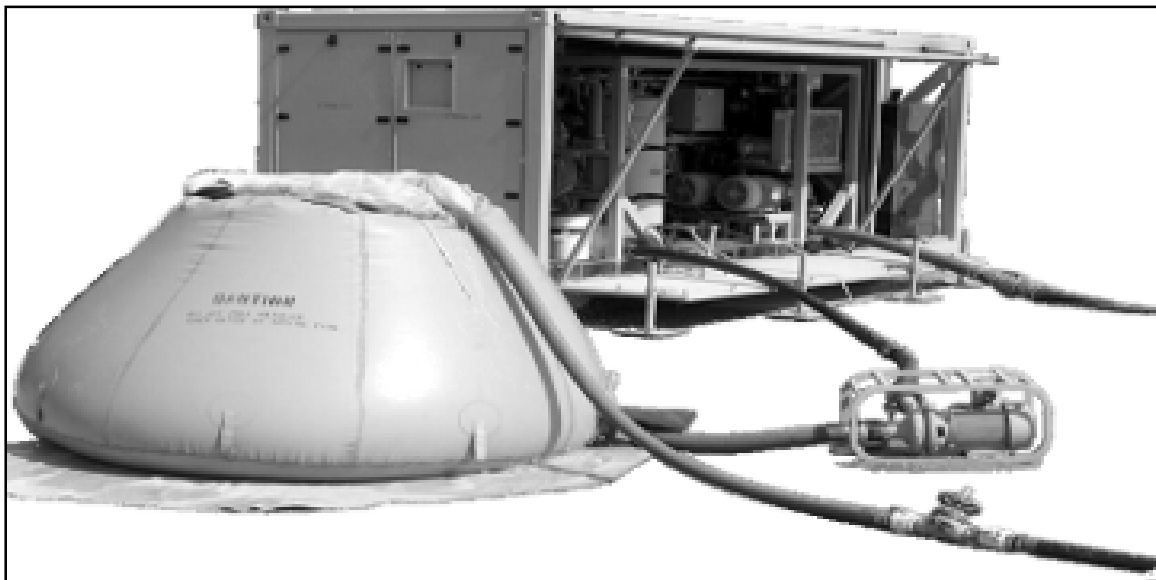

Figure 4-7. Tactical Water Purification System (TWPS)

TWPS Characteristics, Capabilities and Features

4-100. The following are characteristics, capabilities and features of the TWPS:

- Positioned no greater than 330 feet from raw water source.
- Area requirement is 75 feet by 100 feet.
- Produces 1,500 GPH from freshwater and 1,200 GPH from saltwater (temperature dependent).
- Utilizes micro-filtration and reverse osmosis technology to produce potable water from virtually any raw water source.

- Mounted on a load handling system (LHS) or palletized load system (PLS) compatible flat rack for transport. The system frame is also international standards organization (ISO) compatible.
- Equipment can be set-up with three personnel, and operated with at least three personnel.
- Designed for operation between -25° F (-32° C) and 120° F (49°C). At freezing temperatures, a cold weather kit is necessary. Temperatures of the source water cannot be greater than 100°F.

TWPS Major Components

4-101. The following are major components of the TWPS:

- Two 3,000 gallon product tanks (additional 9,000 gallons with extended distribution kit).
- One 1,000 gallon microfiltration feed tank.
- One 1,500 gallon cleaning waste tank.
- 60 kilowatt tactical quiet generator.
- Micro filtration system.
- Reverse osmosis system.
- Chemical injection system.
- Standard product water distribution system.
- Extended product water distribution system.
- Ocean intake structure system kit.
- Cold weather kit.
- CBRN filter.

3,000 GPH REVERSE OSMOSIS WATER PURIFICATION UNIT (ROWPU)

4-102. The ROWPU is a fully contained mobile water purification system capable of purifying, storing and dispensing water meeting military field water standards for long term consumption. A ROWPU is contained in a special 8X8X20 foot international standards organization container with skid-mounted external components, all mounted on a M871 30 foot trailer. ROWPUs are used to support large scale military operations, as they have the highest production capability of all three water treatment systems. The ROWPU purifies all classifications of raw water to make potable water, including CBRN contaminated water. Figure 4-8 displays a picture of an operational ROWPU.



Figure 4-8. Reverse Osmosis Water Purification Unit (ROWPU)

ROWPU Characteristics, Capabilities and Features

4-103. The following are characteristics, capabilities and features of the ROWPU:

- No greater than 200 feet from raw water source.
- Area requirement is 35 feet by 70 feet.
- Produces 3,000 GPH from freshwater and 2,000 GPH from saltwater (temperature dependent).
- Utilizes media filtration and reverse osmosis technology to produce potable water from virtually any raw water source.
- Mounted on a 30 foot standard M871 trailer for transport.
- Equipment can be set-up with three personnel, and operated with at least three personnel.
- Operates in temperatures between -25°F and 110°F (-32°C and 43°C).
- Winterization kit must be used if operating temperature is below 32°F (0°C).
- Temperatures of the source water cannot be greater than 110°F (43°C).

ROWPU Major Components

4-104. The following are major components of the ROWPU:

- Three 3,000 gallon product tanks.
- 60 kilowatt tactical (or non-tactical) quiet generator.
- Raw water intake system.
- Multimedia and cartridge filtration system.
- Reverse osmosis system.
- Potable water distribution system.
- Cold weather kit.
- CBRN filter.

MARINE CORPS WATER TREATMENT SYSTEMS

4-105. There are two types of water treatment systems organic to Marine Corps units. These systems are the lightweight water purification system (LWPS) and the tactical water purification system (TWPS). Chapter one discusses the types of units where these systems reside within the Marine Corps. For detailed information on system specifications and maintenance requirements refer to the system TM.

LIGHTWEIGHT WATER PURIFICATION SYSTEM (LWPS)

4-106. The Lightweight Water Purification System (LWPS) specifically addresses the need for a portable, lightweight, easily maintained, and all source capable water purification unit. The Marine Corps LWPS is dissimilar to the Army LWP. The LWPS is a reverse osmosis modular unit that is optimally equipped to achieve small-scale, absolute water purification in any field condition. It was developed for use by highly mobile teams in remote areas or emergency or temporary sites. Its versatile footprint provides for self-contained, potable water support without committing larger water production assets from a support structure. Thus, the LWPS is able to provide sustainable pure water support in expeditionary environments. The LWPS has an easy-access, open-frame design and all connections are quick-release for easy maintenance and quick element or parts replacement. It is configured in an ultra-lightweight, modular design to ensure portability and adaptive layout. The LWPS is capable of purifying any source water, even contaminated by CBRN agents. The LWPS consists of 14 components that are connected by various hoses and fittings. Figure 4-9 on page 4-24 displays a picture of a LWPS.



Figure 4-9. Lightweight Water Purification System (LWPS)

LWPS Characteristics, Capabilities and Features

- 4-107. The following are characteristics, capabilities and features of the LWPS:
- Positioned no greater than 300 feet from raw water source.
 - Produces 125 GPH from freshwater and 75 GPH from saltwater (temperature dependent).
 - Utilizes media filtration, cartridge filtration and reverse osmosis technology to produce potable water from virtually any raw water source.
 - The LWPS is supplied and transported in a quadruple container (QUADCON).
 - The LWPS is designed to fit in a M1152 high mobility multipurpose wheeled vehicle or M1102H trailer. It can be sling-loaded by helicopter or transported in fixed wing aircraft.
 - Equipment can be unloaded and set-up with two personnel without material handling equipment. The LWPS is designed to be operated and maintained by one individual.
 - The LWPS cold weather kit is employed during cold weather operations (temperatures below 32°F [0°C]) to prevent water in the LWPS from freezing. To prevent damage to reverse osmosis elements, keep elements away from temperatures above 113°F (45°C).

LWPS Major Components

- 4-108. The following are major components of the LWPS:
- One 3,000 gallon product water tank.
 - One 1,000 gallon raw water tank.
 - 125 GPH raw water pump module.
 - Floating intake strainer and ocean intake structure system (OISS).
 - Strainer separator module.
 - Media/cartridge filter modules.
 - High-pressure pump module.
 - Reverse osmosis modules.
 - Chlorinator injector.

- Product water pump module.
- Dispenser nozzles.
- Cold weather kit (additional heated tent required).
- CBRN kit.
- CBRN contamination avoidance covers.

LIGHTWEIGHT WATER PURIFICATION SYSTEM INCREASED PRODUCTION MODULE (LWPS IPM)

4-109. The LWPS IPM is an extended capability module which can be added to the LWPS to double water production while significantly reducing fuel consumption. Because of the LWPS unique flow and scalability, production is doubled by adding a second set of high pressure pump and reverse osmosis modules to the base system. A maximum total production of 600 GPH can be achieved while the total operational footprint is increased by only a few feet.

MARINE CORPS TACTICAL WATER PURIFICATION SYSTEM (TWPS)

4-110. The Marine Corps TWPS is a skid mounted system transportable by the medium tactical vehicle replacement truck (MK 23 or MK 25) or by a 5-ton forklift. The system includes the basic TWPS skid, 6,000-gallon water storage capability, and all basic issue items. Figure 4-10 displays a picture of the Marine Corps TWPS. While the Marine Corps TWPS shares the same internal components and production capability as the Army TWPS discussed above, the Marine Corps TWPS differs in the following ways:

- Skid mounted, forklift support required (not LHS, PLS, or international standards organization (ISO) compatible).
- Power source not included with system (can be powered with 60 kilowatt generator).
- Ocean intake structure system, supplemental cleaning, waste and storage kit, cold weather kit, CBRN kit, and CBRN survivability kit are purchased and deployed separately as required (system does not include extended capability modules).

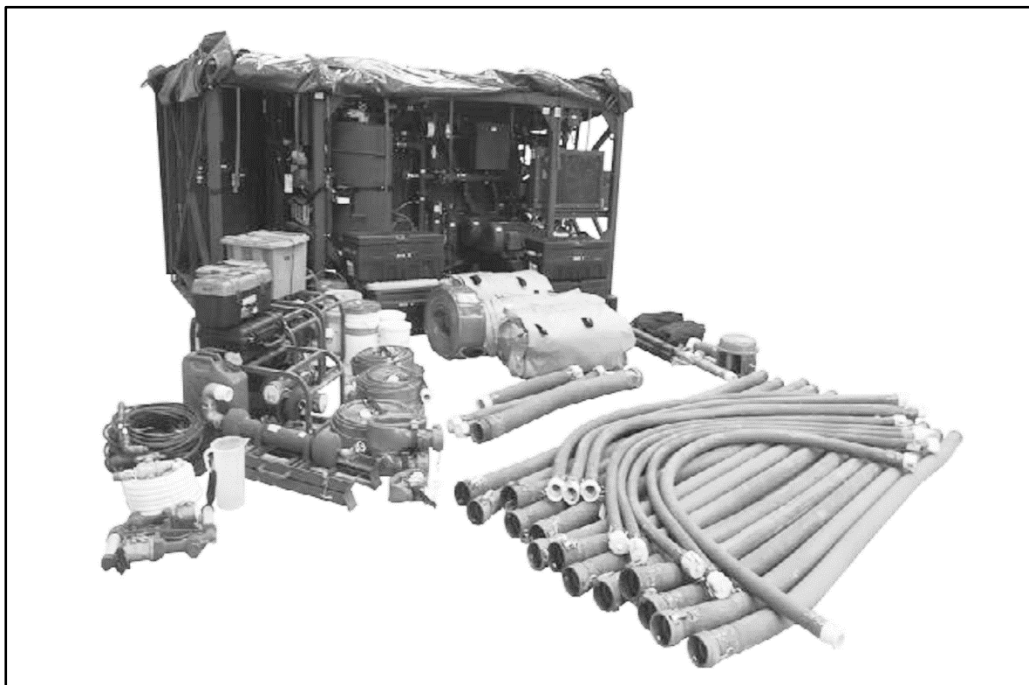

Figure 4-10. Marine Corps Tactical Water Purification System (TWPS)

This page intentionally left blank.

Chapter 5

Water Storage, Distribution, and Issue Operations

This chapter will discuss water storage, distribution and issue. Water units store potable bulk water to build required quantities in support of tactical operations. Distribution systems are used to issue water for forward resupply, or directly to end users. Types of storage and distribution systems and required reports are detailed in this chapter.

WATER STORAGE OPERATIONS

5-1. After water is purified and certified potable by preventive medicine personnel, it may be consumed immediately. Water is initially stored in 3,000 gallon collapsible fabric tanks at the water treatment area. In many situations (especially at echelons above brigade) water is then transferred to a storage area, typically within close proximity to the water treatment area. The required amount of bulk water storage depends on many factors:

- Consumption requirements.
- Days of supply requirements.
- Water purification capacity.
- Distance to water source.
- Availability of redundant water supply.
- Environment and weather.
- Physical space and security.
- Other mission variables.

5-2. The petroleum and chemical requirements section in chapter four, paragraphs 4-84 through 4-87, applies to water storage system operations. Water treatment specialists are responsible for submitting petroleum and chemical requirements to the unit supply sergeant.

HYPO-CHLORINATION REQUIREMENTS

5-3. **Hypo-chlorination is the application of a hypo-chlorinator to feed calcium or sodium hypochlorite.** Hypo-chlorination is used for the purpose of maintaining a disinfectant residual during water storage. It aids in maintaining optimum water quality at the time when it is consumed by end users. Stored bulk water is chlorinated at different standards based on the amount of expected storage time prior to end user consumption. Stored bulk water should be maintained so that at least 0.2 mg/L FAC is present at the point of use. These standards are outlined in TBMED 577.

BULK WATER STORAGE AND DISTRIBUTION AREAS

5-4. Water treatment specialists will adjust the chlorine level at potable water issue points during bulk storage and distribution operations so that FAC residuals remain at 1.0 mg/L. Maintaining 1.0 mg/L or greater in the distribution system may require chlorine levels at the production site greater than 1.0 mg/L after a 30-minute contact time.

UNIT AND INDIVIDUAL LEVEL

5-5. Regardless of the treatment methodology, a minimum 0.2 mg/L FAC residual must be maintained in unit level distribution containers (HIPPOs, 800-gallon camels, 400-gallon water trailers, and drums). As discussed earlier in this chapter, the intent of this requirement is to provide water that is both potable and palatable to Soldiers and Marines. Therefore, water treatment specialists should make every attempt to

provide water to the individual service member with the lowest chlorine residual possible that ensures potability. Preventive medicine personnel will monitor water storage and distribution systems to ensure chlorine residuals maintain potability.

BULK WATER STORAGE SYSTEMS

5-6. The water storage and distribution system (WSDS) is the primary system used to store bulk water in a theater of operations. There are three types of WSDSs: a 40,000 gallon WSDS, a 300,000 gallon WSDS, and an 800,000 gallon WSDS. The systems can be configured in many different ways based on storage requirements and available terrain. Figure 5-1 and figure 5-2 are examples of how the 40,000 gallon and 300,000 gallon WSDSs may be configured. The Force Provider water storage and distribution subsystem and gray water collection subsystem are expeditionary modular equipment sets that may be fielded to deployed units as part of a prepackaged base camp.

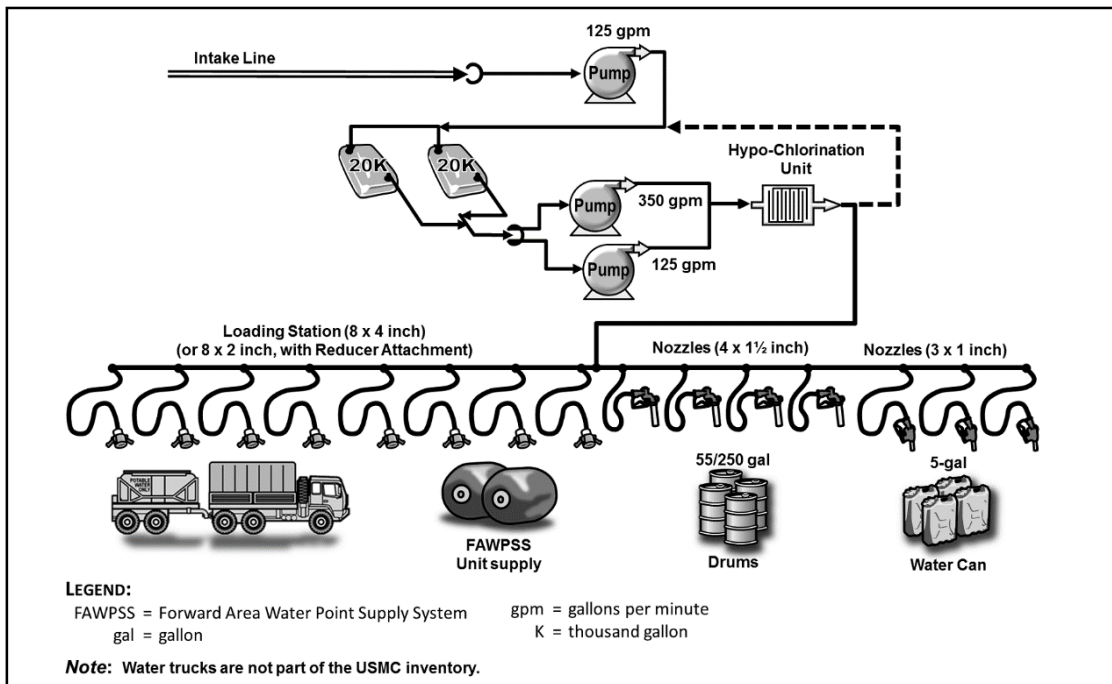

Figure 5-1. 40,000 Gallon Water Storage and Distribution System (WSDS)

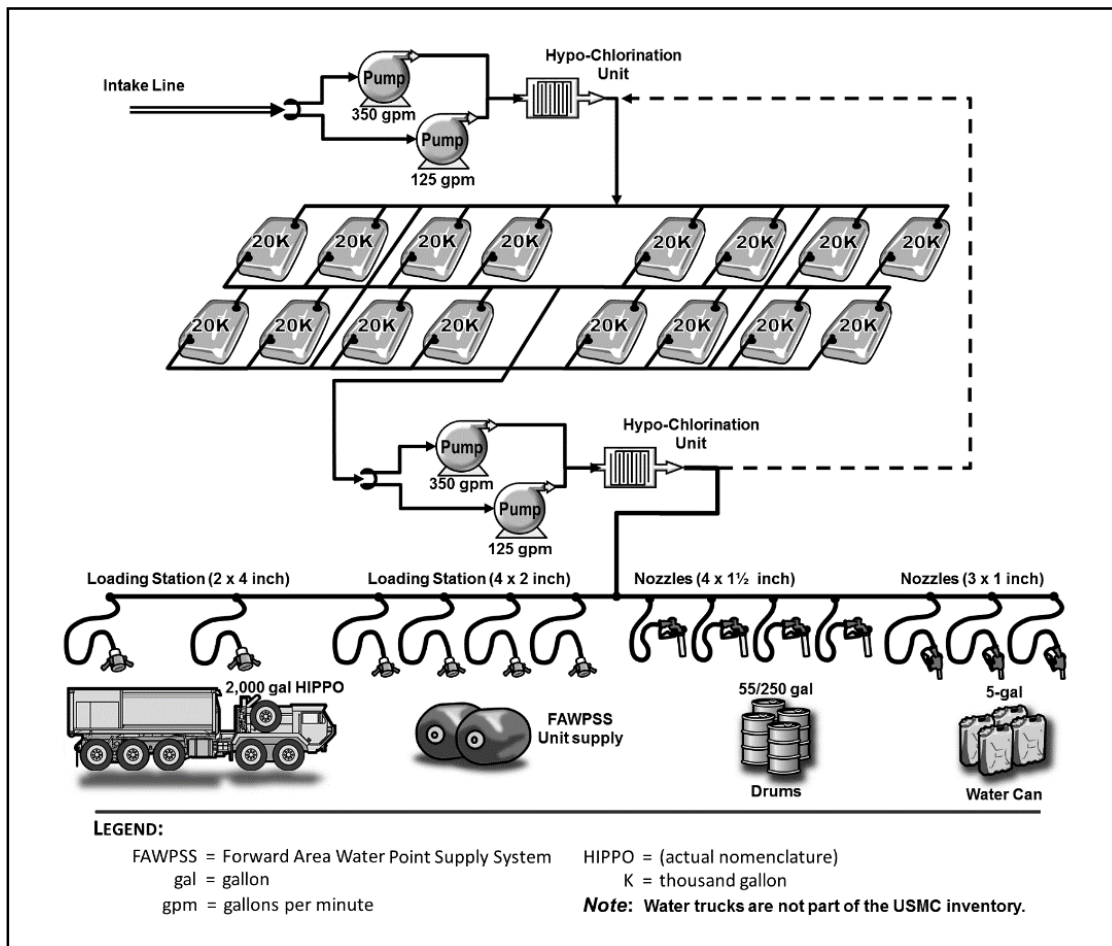

Figure 5-2. 300,000 Gallon Water Storage and Distribution System (WSDS)

WATER STORAGE AND DISTRIBUTION SYSTEM (WSDS)

5-7. The WSDS is a modular storage system, which means that any combination of storage tanks may be used collectively or individually. The WSDS can be divided into four basic components: tanks, pumps, hypo-chlorinator, and distribution equipment. The 40,000 gallon system is equipped with three 20,000 gallon collapsible fabric tanks (one spare), and the 300,000 gallon system is equipped with sixteen 20,000 gallon tanks (one spare). The 800,000 gallon system is equipped with sixteen 50,000 gallon collapsible fabric tanks (one spare). Water can be issued to tank trucks, water trailers, Forward Area Water Point Supply Systems (FAWPSS), or small unit containers such as five gallon cans. The 40,000 WSDS is typically organic to quartermaster water units at echelons above brigade, while larger systems are drawn from Army Prepositioned Stock to meet operational storage requirements.

FORCE PROVIDER EXPEDITIONARY MODULAR

5-8. Force Provider Expeditionary Modular is a readily deployable, containerized and prepackaged base camp equipped for feeding, billeting, and provided health, hygiene, and medical services for up to 600 personnel. The package comes with a water storage and distribution subsystem and a gray water collection subsystem.

5-9. The water storage and distribution subsystem consists of four 20,000 gallon storage and distribution sites and four 400 gallon water trailers for distribution. Electric pumps, hypo-chlorinators, hoses, valves, fittings, nozzle kits and other accessories accompany the system. The water for Force Provider systems may

be from a quartermaster water support company, an approved host nation commercial water system, by contractor delivery from an approved water source, or from on-site wells constructed by an engineer unit.

5-10. The gray water collection subsystem collects, stores, and disperses gray water from the food service subsystem, containerized batch laundries and portable field shower assemblies. The system consists of two 20,000 gallon collapsible fabric tanks, sewage ejection pumps, piping, suction and discharge hoses, fittings, and valves required for operation.

WATER DISTRIBUTION OPERATIONS

5-11. Bulk water distribution occurs at all echelons from ASCC to company level. Army quartermaster units and Marine Corps engineering units are designed to provide unit distribution to a brigade or battalion supply point, which is typically the preferred method of resupply. However, a combination of both unit distribution, supply point distribution, and throughput distribution may be required at various echelons to meet water consumption requirements. Water may be stored and distributed at multiple locations, multiple times prior to reaching the end user. As detailed in the hypo-chlorination section at the beginning of this chapter, water is chlorinated at different levels to maintain potability up until end user consumption.

5-12. The petroleum and chemical requirements section in chapter four, paragraphs 4-84 through 4-87, applies to water distribution system operations. Water treatment specialists are responsible for submitting petroleum and chemical requirements to the unit supply sergeant.

5-13. Quartermaster units use DA Form 1714-1 (Daily Water Distribution Log) to track receipt and distribution of bulk water. The distribution log allows units to calculate how much water is on hand at the end of each day (total receive minus total dispatched). The log provides accurate historical data which aids logistics planners in establishing a water distribution schedule for supported units.

WATER DISTRIBUTION SYSTEMS

5-14. Water distribution systems range from a Tactical Water Distribution System (TWDS) to a five gallon water can. The type of distribution system employed depends on several factors:

- Consumption requirements.
- Water purification and storage capability.
- Location of supported units.
- Distance from potable water source to issue point.
- Environment and weather.
- Physical space and security.
- Other mission variables.

TACTICAL WATER DISTRIBUTION SYSTEM (TWDS)

5-15. A TWDS is employed when large volumes of water must be moved from a water treatment area to a storage or distribution area. TWDS are organic to Tactical Water Distribution (Hoseline) Detachments which exist in the Army Reserve and Army National Guard. The mission of the Tactical Water Distribution Detachment is to distribute potable water to Corps and Theater level units. Hoseline detachments typically lay, operate, and recover TWDSs in support of a water support company. The system consists of six 600 gallon per minute pumping stations, a 10-mile hoseline segment, two storage assemblies, and two distribution points. The TWDS can transport 720,000 gallons of water within a 24 hour period (20 operational hours). The system TM covers reconnaissance considerations, components, installation, operation, and maintenance requirements. Figure 5-3 is a condensed diagram of the major components of a TWDS.

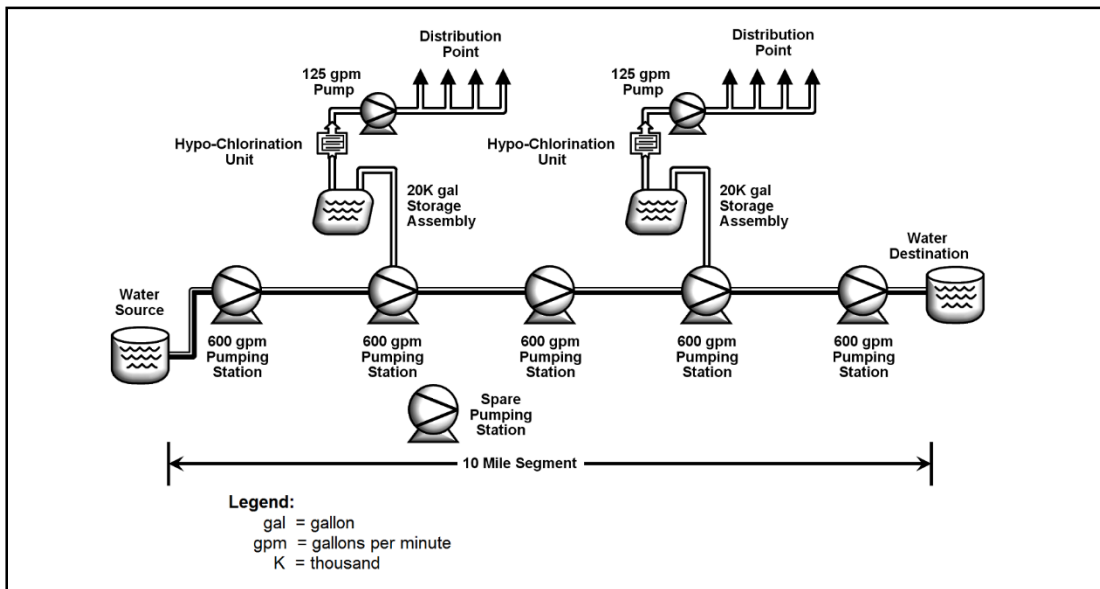

Figure 5-3. Tactical Water Distribution System (TWDS)

FORWARD AREA WATER POINT SUPPLY SYSTEM (FAWPSS)

5-16. The FAWPSS is a potable water distribution system that can receive, store, and issue drinking water. The system consists of six 500 gallon fabric drums, 125 gallons per minute pump unit, hoses, and dispensing nozzles. Two water drums (Model LAB 9095) or three water drums (Model M105) are connected to the system at one time. These drums provide water by the suction of the pump to four distribution nozzles where the water is manually discharged. It is packaged and transported in a triple container. Fabric drums can be line hauled or sling loaded to forward units. Three fabric drums can fit on a PLS flat rack for movement. See TM for additional information on operation and maintenance. Figure 5-4 displays a picture of a FAWPSS.



Figure 5-4. Forward Area Water Point Supply System (FAWPSS)

2,000 GALLON LOAD HANDLING SYSTEM (LHS) COMPATIBLE WATER TANK RACK SYSTEM (HIPPO)

5-17. The HIPPO is a mobile hard wall system used to perform bulk and retail potable water distribution and storage. The HIPPO consists of a 2,000 gallon capacity water tank rack with pump, filling station, 70 foot hose reel, and bulk suction and discharge hoses. The filling station is capable of discharging water either by gravity or utilization of the on-board pump system. It is fully functional whether mounted or dismounted, and is mobile when it is full, partially full, or empty. The HIPPO prevents water from freezing during temperatures as low as -25° Fahrenheit. The tank consists of an inner shell, heating blankets, and an outer shell, secured by tank banding straps. It is compatible with the use of Heavy Equipment Mobility Tactical Truck, LHS truck, the palletized load system truck, and palletized load system trailer. The LHS truck cannot lift the HIPPO from the ground when fully loaded since the HIPPO weight exceeds the LHS maximum lifting capabilities, which can damage the hydraulics system.

5-18. The unit is capable of being transported by highway, rail, marine, and air mode worldwide without disassembly. The HIPPO is conformed dimensionally to the length and width of a standard 20 foot freight container. It can be lifted from the four top corner fittings and four bottom corner fittings. The HIPPO can also be lifted with a forklift of adequate capacity (weight varies when full, partially full, or empty). Figure 5-5 displays a picture of the HIPPO.



Figure 5-5. 2,000 Gallon Load Handling System (LHS) Compatible Water Tank Rack System (HIPPO)

SEMITRAILER MOUNTED FABRIC TANK

5-19. 5,000 gallon semitrailer mounted fabric tanks are kept in Army Prepositioned Stock, as they are not organic equipment to any quartermaster or transportation units. Medium truck companies can haul these fabric tanks on M872 trailers to increase a sustainment unit's water distribution capability in a theater of operations.

UNIT WATER POD SYSTEM (CAMEL II)

5-20. The camel is an 800 gallon system that provides modular forces a capability to receive and issue potable bulk water. The system consists of an 800-gallon capacity baffled water tank with integrated freeze protection, all mounted on an M1095 medium tactical vehicle trailer. The camel has a filling stand for individual containers. Figure 5-6 displays a picture of the camel II system.



Figure 5-6. Unit Water Pod System (Camel II)

400 GALLON WATER BUFFALO

5-21. The water buffalo is a 400 gallon water trailer that provides modular forces a capability to receive and issue potable bulk water. The system can be towed by medium tactical vehicle and heavy expanded mobile tactical truck variants, as well as other prime movers that have appropriate tow capacity and electrical connectors. Figure 5-7 displays a picture of a water buffalo.

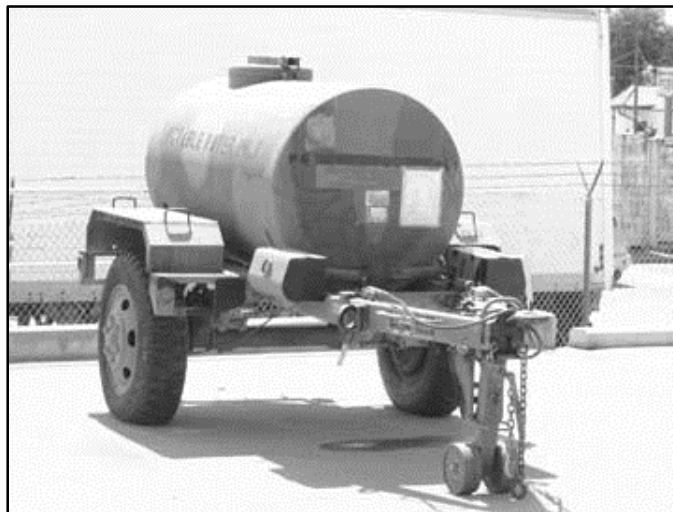

Figure 5-7. Water Buffalo

500 GALLON, 250 GALLON, AND 55 GALLON COLLAPSIBLE WATER DRUMS

5-22. Collapsible water drums are used for storage and transportation of potable water. Water drums are constructed of water-resistant synthetic rubber impregnated rayon. Water drums can move on all modes of transportation, to include sling load. Components of the 500 gallon and 250 gallon drums are a towing and lifting yoke, tie-down kit, and repair kit. The 55 gallon drum is equipped with D-ring fitted end plates. A tie-down kit and repair kit are also components of the 55 gallon drum.

5 GALLON WATER CAN

5-23. The five gallon water can is part of all unit water distribution capabilities. Five gallon water cans can be moved by an individual Soldier or Marine over short distances. Water cans are ordered through the supply system using national stock number 7240-00-089-3827. The national stock number for replacement lids is 7240-00-089-7312.

MARINE CORPS WATER STORAGE AND DISTRIBUTION SYSTEMS

5-24. Storage and distribution systems organic to Marine Corps units include the five gallon water can (listed above), collapsible storage tanks, the water six container (SIXCON) system, the 400 gallon water buffalo, and the expeditionary water distribution system (EWDS).

EXPEDITIONARY WATER DISTRIBUTION SYSTEM (EWDS)

5-25. The Marine Corps EWDS is a small section of the Army TWDS (discussed earlier in this section), which was reconfigured to gain efficiencies and enhance capabilities that are scalable to the operational requirement. The system is broken down into modular 1.4 mile segment kits. Each EWDS consists of two 600 gallons per minute pumps, one hypochlorinator, one hose reel system, connection sets (two, four, and six inch), and 1.4 miles of main line hose (6 inch by 500 foot sections). The 20,000 gallon and 50,000 gallon collapsible fabric tanks are stand-alone end items that can be employed with the EWDS as needed.

SIX CONTAINERS TOGETHER (SIXCON) SYSTEM

5-26. The water SIXCON system is a modular system consisting of five water tank modules and one pump module. The six modules attach together to form a 20 foot international standards organization (ISO) configuration. The SIXCON water storage module is a component of the SIXCON system. The water storage module is a stainless steel tank encased within the module frame, and a capacity of 900 gallons each. The total capacity of five modules connected together is 4,500 gallons. The water tank is covered with at least

one inch of foam insulation to keep stored water from freezing or heating up. The SIXCON water pump module has the capability for dispensing potable water (includes ancillary components for two dispensing points) and interconnecting components for connecting the water and pump modules together. The SIXCON system can be used as a mobile water dispensing asset or as a stationary dispensing capability. Figure 5-8 displays a picture of the SIXCON water storage module. Figure 5-9 displays a picture of the SIXCON water pump module.



Figure 5-8. Six Container (SIXCON) Water Storage Module



Figure 5-9. Six Container (SIXCON) Water Pump Module

400 GALLON WATER BUFFALO

5-27. The water buffalo is a 400 gallon water trailer that is used to receive and issue potable bulk water. The water tank is constructed of stainless steel with double walls. Two inches of urethane foam is used as insulation between the walls. It is equipped with dispensing equipment consisting of four bronze faucets, a rear self-drain faucet and brass piping. A shut-off valve is provided to complete drainage from the exterior plumbing. A manhole located on top of the water tank provides access for bulk filling and cleaning. A picture of a water buffalo is displayed in figure 5-7 on page 5-7.

WATER ISSUE

5-28. Water can be issued from storage and distribution systems directly to an end user, or for supply point distribution, unit distribution, or throughput distribution to supported units. Water issued from water supply points at all echelons must be tracked closely to ensure accurate historical data is captured. Historical data ensures that unit logistics planners and water treatment specialists are using accurate data forecast future demand requirements. DA Form 1714 (Daily Water Issue Log) is used to capture historical data.

SAFETY AND ENVIRONMENTAL STEWARDSHIP

5-29. Water treatment specialists must adhere to safety guidelines in equipment technical manuals to prevent death or severe injury during transportation, installation, operation, and recovery of water storage and distribution systems. Environmental stewardship measures discussed in chapter four, paragraph 4-93 and 4-94 also apply to water storage, distribution and issue operations.

This page intentionally left blank.

Appendix A

Water Planning Factor Tables

ARMY WATER PROPONENCY

A-1. Within the Department of the Army, the assistant chief of staff, logistics (G-4) is designated as the Army staff proponent for all land based water resource matters. Under the guidance and policies of the Army G-4, the U.S. Army Training and Doctrine Command (TRADOC) is responsible for validating DOD and Army water consumption planning factors. Within TRADOC, the U.S. Army Combined Arms Support Command (CASCOM) is the TRADOC proponent for the development, validation, and maintenance of Army water consumption planning factors. To accomplish this, the CASCOM acquires battlefield functional mission water usage profile data from related studies and other appropriate proponents. A complete water planning guide is available for download on the U.S. Army Quartermaster Petroleum and Water Department website.

WATER PLANNING FACTOR TABLES

A-2. The water planning factor tables presented in this section were developed for general theater planning. Planners may modify or adjust these standard planning factors based on latest logistics preparation of the battlefield assessments or other unique conditions associated with a given operation or area of operation. They are based on a central hygiene standard of two showers and fifteen pounds of laundry per Soldier (or Marine) per week. They include a 10% loss factor (4% evaporation and 6% waste/spillage) for all environments. The shaded areas represent potable water, which applies to all functions in an arid environment.

A-3. Table A-1 and A-2 on page A-2 are water planning factor tables for conventional and integrated theaters, respectively. A conventional theater is one in which no use of CBRN weapons is anticipated, and applies to areas not subject to CBRN attack. An integrated theater is one in which one or more opponents have CBRN weapons available and employment is anticipated (all areas subject to CBRN attack). Additional planning factor tables and background information is located in a complete water planning guide, available for download on the U.S. Army Quartermaster Petroleum and Water Department website.

SUSTAINING AND MINIMUM WATER CONSUMPTION

A-4. Sustaining water consumption (“Sus” in tables) is the sustaining amount of water that is required to maintain a military force mission effectiveness for a period in excess of one week. Under this water consumption condition, all functions dependent on water are satisfied for the duration of the operation without any degradation. In hot, arid environmental regions, sustainment functions are expanded to include engineer, aircraft, and vehicle maintenance.

A-5. Minimum water consumption (“Min” in tables) is the minimum amount of water that is required to maintain military force mission effectiveness for a period of up to one week. Minimum rates identified in this section reflect water consumption in times of water shortage or intense combat. Consumption under these conditions includes only essential functions. In all environmental regions, these functions include drinking, personal hygiene, food preparation, medical operations and heat casualty treatment. In hot, arid environmental regions, essential functions are expanded to include aircraft and vehicle maintenance.

Table A-1. Standard planning factors related to personnel in force (gal/person/day), conventional theater

Function	Hot				Temperate		Cold	
	Tropical		Arid		Sus	Min	Sus	Min
	Sus	Min	Sus	Min				
Universal Unit Level Consumption ¹	6.91	4.87	7.27	5.23	5.26	3.22	5.81	3.77
Role I and II Medical Treatment	0.03	0.03	0.03	0.03	0.03	0.03	0.03	0.03
Role III and IV Medical Treatment	0.88	0.88	0.88	0.88	0.88	0.88	0.88	0.88
Central Hygiene - Showers	2.07	1.87	2.07	1.87	2.07	1.87	2.07	1.87
Mortuary Affairs Operations	0.03	0.03	0.22	0.22	0.03	0.03	0.03	0.03
Potable Total	9.92	7.68	10.47	8.23	8.27	6.03	8.82	6.58
Centralized Hygiene – Laundry ²	0.26	0.12	0.26	0.12	0.26	0.12	0.26	0.12
Mortuary Affairs Operations	0.19	0.19	NA	NA	0.14	0.14	0.14	0.14
Engineer Construction	1.98	0.00	1.98	0.00	1.98	0.00	1.98	0.00
Aircraft Maintenance	0.14	0.14	0.14	0.14	0.14	0.14	0.14	0.14
Vehicle Maintenance (Non-potable part of UUL)	0.36	0.36	NA	NA	0.19	0.19	0.19	0.19
Non-potable Total³	2.93	0.81	NA	NA	2.72	0.60	2.72	0.60
Theater Total	12.86	8.49	12.86	8.49	10.99	6.63	11.54	7.18

Sus = Sustaining Min = Minimum
 1 – Includes gal/person/day requirements for drinking, personal hygiene, field feeding, heat injury treatment, and vehicle maintenance.
 2 – Based on a central hygiene goal of two showers and 15 pounds of laundry per Soldier (or Marine) per week.
 3 – All potable in arid environment.

Table A-2. Standard planning factors related to personnel in force (gal/person/day), integrated theater

Function	Hot				Temperate		Cold	
	Tropical		Arid		Sus	Min	Sus	Min
	Sus	Min	Sus	Min				
Universal Unit Level Consumption ¹	7.46	5.41	7.82	5.77	6.36	4.31	5.81	3.76
Role I and II Medical Treatment	0.03	0.03	0.03	0.03	0.03	0.03	0.03	0.03
Role III and IV Medical Treatment	0.88	0.88	0.88	0.88	0.88	0.88	0.88	0.88
Central Hygiene - Showers	2.07	1.87	2.07	1.87	2.07	1.87	2.07	1.87
Mortuary Affairs Operations	0.03	0.03	0.23	0.23	0.03	0.03	0.03	0.03
CBRN Decontamination	1.05	1.05	2.12	2.12	1.05	1.05	1.05	1.05
Potable Total	11.52	9.28	13.15	10.90	10.42	8.18	9.87	7.63
Central Hygiene – Laundry ²	0.26	0.12	0.26	0.12	0.26	0.12	0.26	0.12
Mortuary Affairs Operations	0.20	0.20	NA	NA	0.15	0.15	0.15	0.15
Engineer Construction	1.98	0.00	1.98	0.00	1.98	0.00	1.98	0.00
Aircraft Maintenance	0.14	0.14	0.14	0.14	0.14	0.14	0.14	0.14
Vehicle Maintenance (Non-potable part of UUL)	0.36	0.36	NA	NA	0.19	0.19	0.19	0.19
CBRN Decontamination	1.91	1.91	NA	NA	1.91	1.91	1.91	1.91
Non-potable Total³	4.86	2.73	NA	NA	4.64	2.52	4.64	2.52
Theater Total	16.38	12.01	15.54	11.17	15.07	10.69	14.52	10.14

Sus = Sustaining Min = Minimum
 1 – Includes gal/person/day requirements for drinking, personal hygiene, field feeding, heat injury treatment, and vehicle maintenance.
 2 – Based on a central hygiene goal of two showers and 15 pounds of laundry per Soldier (or Marine) per week.
 3 – All potable in arid environment.

Appendix B

Deployment Planning Considerations

B-1. Water treatment specialists should assess the planning considerations presented in Table B-1 in preparation for deployment. Planners and operators should modify or adjust these considerations based on latest logistics preparation of the battlefield assessments or other unique conditions associated with a given operation or area of operation.

Table B-1. Deployment planning considerations

Administrative	
1	Equipment information is annotated in GCSS-Army or GCSS-Marine Corps (all)
2	Check on status/services of equipment (all)
3	Operators licensed on all water treatment systems
4	Sustainment training conducted (MOS training)
5	MOS training annotated on company training calendar
6	Location and availability of training areas to conduct water support operations (EPA permit requirements)
7	Attain point of contact for preventive medicine
8	Maintain water reports, logs, and forms to capture historical data
9	Receive commander's intent for water operations
10	Establish unit standard operating procedure
Chemicals IAW TB MED 577	
1	Verify shelf life of chemicals (all)
2	Verify days of supply required for deployment (all)
3	Verify amount of chemical on hand / needed (all)
4	Identify all national stock numbers for reorder procedures
5	Identify and communicate with various distributors
WQAS-P Kit, Color test kit, M329 Joint Chemical, Biological, Radiological Agent Water Monitor	
1	Verify batteries on hand/ needed (all)
2	Verify solutions on hand/ needed/ expiration dates (all)
3	Verify kits are complete (all)
4	Verify kit calibration (all)
5	Verify number of kits on hand/ needed (all)
6	Verify personal protective equipment on hand/ needed/ serviceability
7	Identify additional kits for emergency purposes
8	Identify all national stock numbers for reorder procedures
9	Identify chemicals that can be shipped
LWP, TWPS, 3K ROWPU IAW STP 10-92W14-SM-TG & Technical Manuals	
1	Inventory system (all)
2	Verify most recent service (all)
3	Verify frequency of winter preservation (all)
4	Check mission capability of equipment (all)

Table B-1. Deployment planning considerations (continued)

LWP, TWPS, 3K ROWPU IAW STP 10-92W14-SM-TG & Technical Manuals	
5	Verify hours of operation (all)
6	Verify frequency of reverse osmosis element replacement (all)
7	Verify number of reverse osmosis elements on hand/needed (all)
8	Verify frequency of MF or UF replacement (all)
9	Verify number of MF or UF on hand/needed (all)
10	Verify the carbon and resin replacement for CBRN canister (all)
11	Verify Media on hand/needed (ROWPU)
12	Verify serviceability of storage tanks (all)
13	Verify storage tanks on hand/needed (all)
14	Verify S1 strainers on hand/needed (TWPS)
15	Verify Internal Strainers on hand/needed (all)
16	Verify Rupture Disc on hand/needed (all)
17	Verify Air Pump on hand/needed (LWP)
18	Verify cold weather kit serviceability (all)
19	Verify serviceability of containers (LWP)
20	Verify tool kits on hand/needed (all)
Storage & Distribution Equipment IAW TB MED 577 & Technical Manuals	
1	Check serviceability of bags and cleanliness IAW TB MED 577 (all)
2	Verify bags on hand/needed (all)
3	Check serviceability of hoses (all)
4	Check hoses on hand/needed (all)
5	Check pump serviceability (all)
6	Verify pumps on hand/needed (all)
7	Verify HIPPO inspection dates and forms IAW TB MED 577
8	Check if the company has a sling load requirement
CBRN = chemical, biological, radiological, nuclear LWP = lightweight water purifier GCSS = global combat support system HIPPO = LHS compatible water tank rack IAW = in accordance with MF = microfiltration MOS = military occupational specialty TWPS = tactical water purification system ROWPU = reverse osmosis water purification unit UF = ultrafiltration WQAS-P = water quality analysis set-purification	

Appendix C

Computations for Water Support Operations

C-1. This appendix provides computations that will assist operators in assessing the performance of a water site. Basic arithmetic can be used to solve water support problems that are common to water support operations. Table C-1 provides water support formulas.

Table C-1. Water support formulas

	Conversion or Calculation	Formula
1	Volume to weight of water	Weight of water in pounds = cubic feet of water x 62.4
2	Vertical feet of water to pounds per square inch	Pounds per square inch = vertical feet of water x 0.43
3	Pounds per square inch to vertical feet of water	Vertical feet of water = pounds per square inch x 2.3
4	Volume to gallons of water	Gallons of water = cubic feet of water x 7.5
5	Gallons of water to cubic feet	Cubic feet = gallons of water ÷ 7.5
6	Volume of water tank (rectangular tank)	Volume in cubic feet = length (feet) x width (feet) x height (feet) ($V = L \times W \times H$)
7	Volume of water tank (cylindrical tank)	Volume in cubic feet = π (3.14) x radius ² (radius in feet squared) x height (feet) ($V = \pi \times r^2 \times H$)
8	Quantity of water flowing in a stream	Quantity of water in gallons per minute = 6.4 x Area of stream in square feet (depth x width) x velocity of stream in feet per minute
9	Pounds of chlorine	Pounds of chlorine = (gallons of water x 8.3 x parts per million) ÷ 1,000,000
10	Gallons of water that can be treated with a give supply of chlorine	Gallons of water = (pounds of chlorine x 1,000,000) ÷ (8.3 x parts per million)
11	Parts per million of chlorine present in a treatment tank	Parts per million = (pounds of chlorine x 1,000,000) ÷ (gallons of water x 8.3)
12	Pounds of chlorine to ounces of calcium hypochlorite	Ounces of calcium hypochlorite = Pounds of chlorine x 22.9

C-2. Table C-2 and table C-3 on page C-2 are used to determine how much chlorine material must be used to chlorinate a given amount of water. Water treatments specialists will first determine the desired parts of chlorine per million of water. They will then determine the strength of the solution to be used. The strength of various chlorine solutions are outlined in table C-2.

Table C-2. Strength of chlorine solutions

Type of chlorine material	Strength of chlorine
Liquid sodium hypochlorite	5 percent solution
Solid chlorinated lime	25 percent solution
Solid calcium hypochlorite	70 percent solution
Gaseous chlorine	100 percent solution

C-3. Finally, water treatment specialists will compute the number of gallons to be chlorinated, which will intersect with the amount of chlorine material required in table C-3 on page C-2. TB MED 577 also provides chorine dosage calculators that are useful to water treatment specialists.

Table C-3. Chlorine dosage calculator

<i>Desired parts per million</i>	1	1	1	1	5	5	5	5	25	25	25	25
<i>Strength of chlorine solution</i>	5%	25%	70%	100%	5%	25%	70%	100%	5%	25%	70%	100%
<i>Gallons of water to be chlorinated:</i>												
50,000 gal	1 gal	1 lb 11oz	10 oz	6.7 oz	5 gal	8 lb 6 oz	3 lb	2 lb 2 oz	25 gal	41 lb 12 oz	14 lb 15 oz	10 lb 7 oz
25,000 gal	2 qt	134 oz	5 oz	3.34 oz	2.5 gal	4 lb 3 oz	1 lb 8 oz	1 lb 1 oz	125 gal	20 lb 14 oz	7 lb 8 oz	5 lb 4 oz
10,000 gal	25.6 oz	5.5 oz	2 oz	1.34 oz	1 gal	1 lb 11oz	9.6 oz	6.72 oz	5 gal	8 lb 6 oz	3 lb	2 lb 2 oz
5,000 gal	12.8 oz	2.8 oz	1 oz	.61 oz	2 qt	14 oz	4.8 oz	3.36 oz	2.5 gal	4 lb 3 oz	1 lb 8 oz	1 lb 1 oz
2,000 gal	5.12 oz	1.1 oz	.4 oz	.26 oz	25.6 oz	6 oz	1.92 oz	1.35 oz	1 gal	1 lb 11 oz	9.6 oz	6.68 oz
1,000 gal	2.56 oz	.55 oz	.2 oz	.14 oz	12.8 oz	.3 oz	.96 oz	.68 oz	2 qt	13.6 oz	4.8 oz	3.34 oz
500 gal	1.28 oz	.28 oz	.1 oz		6.4 oz	1.4 oz	.48 oz	.34 oz	1 qt	6.72 oz	2.4 oz	1.67 oz
200 gal	.512 oz	.11 oz			2.56 oz	.56 oz	.2 oz	.14 oz	12.8 oz	2.68 oz	.96 oz	.68 oz
100 gal	.256 oz				1.2 oz	.28 oz	.1 oz	.64 oz	.64 oz	1.35 oz	.48 oz	.34 oz
50 gal	.13 oz				.64 oz	.14 oz			3.2 oz	.68 oz	.24 oz	.17 oz
25 gal	.064 oz				.32 oz				1.6 oz	.34 oz	.12 oz	
10 gal	.026 oz				.128 oz				.64 oz	.14 oz		
5 gal	.013 oz				.064 oz				.32 oz			
gal = gallons					oz = ounces							
lb = pounds					qt = quarts							

Glossary

SECTION I – ACRONYMS AND ABBREVIATIONS

ADP	Army doctrine publication
ADRP	Army doctrine reference publication
AFMAN	Air Force manual
AGC	Army Geospatial Center
AMC	Army Materiel Command
ASCC	Army Service component command
ATP	Army techniques publication
BCT	brigade combat team
BSB	brigade support battalion
C	celsius
CASCOM	Combined Arms Support Command
CBRN	chemical, biological, radiological, and nuclear
CLB	combat logistics battalion (Marine Corps)
CSC	composite supply company
CSSB	combat sustainment support battalion
DA	Department of the Army
DLA	Defense Logistics Agency
DOD	Department of Defense
ESB	engineer support battalion (Marine Corps)
ESC	expeditionary sustainment command
F	fahrenheit
FAC	free available chlorine
FAWPSS	forward area water point supply system
FM	field manual (Army)
FSC	forward support company
G-3	assistant chief of staff, operations
G-4	assistant chief of staff, logistics
GPH	gallons per hour
HIPPO	load handling system (LHS) compatible water tank rack
ILSC	Integrated Logistics Support Center
J-1	manpower and personnel directorate of a joint staff; manpower and personnel staff section
J-3	operations directorate of a joint staff; operations staff section
J-4	logistics directorate of a joint staff; logistics staff section
JP	joint publication
JTF	joint task force
LHS	load handling system
LWP	lightweight water purifier

MAGTF	Marine air-ground task force
MCRP	Marine Corps reference publication
MCWP	Marine Corps warfighting publication
mg/L	milligram(s) per liter (equates to part per million, or ppm)
NATO	North Atlantic Treaty Organization
NTRP	Navy tactical reference publication
NTTP	Navy tactics, techniques, and procedures
OPCON	operational control
OPLOG	operational logistics
pH	potential of hydrogen
PLS	palletized load system
PM	product manager
ppm	parts per million
ROWPU	reverse osmosis water purification unit
SPO	support operations
STANAG	standardization agreement (NATO)
TACOM LCMC	Tank-automotive and Armament Lifecycle Management Command
TB MED	technical bulletin (medical)
TC	training circular
TDS	total dissolved solids
TM	technical manual
TRADOC	Training and Doctrine Command
TSC	theater sustainment command
TWDS	tactical water distribution system
TWPS	tactical water purification system
U.S.	United States
WSDS	water storage and distribution system
WQAS-P	water quality analysis set-purification

SECTION II – TERMS

***alkalinity**

The content of carbonates, bicarbonates, hydroxides, and occasionally berates, silicates, and phosphates in water.

aquifer

A permeable rock formation or subsoil through which ground water moves more or less freely. (TM 3-34.61).

***breakpoint chlorination**

The application of chlorine to water containing free ammonia.

contaminants

Unwanted physical chemical, radiological, or biological materials generally dissolved, suspended, or mixed in water. (TB MED 577)

contamination

1. The deposit, absorption, or adsorption of radioactive material, or of biological or chemical agents on or by structures, areas, personnel, or objects.
2. Food and/or water made unfit for consumption by humans or animals because of the presence of environmental chemicals, radioactive elements, bacteria or organisms, the byproduct of the growth of bacteria or organisms, the decomposing material (to include food substance itself), or waste in the food or water. (JP 1-02)

disinfection

Disinfection is a water treatment process in which pathogenic (disease producing) organisms are killed, destroyed, or otherwise inactivated. Common methods of disinfecting drinking water include boiling, ultraviolet radiation, and various procedures using chlorine, chlorine dioxide, iodine, or ozone. The preferred field method of military water disinfection is chlorination which can be accomplished using chlorine gas or chlorine compounds such as calcium hypochlorite (granular) and sodium hypochlorite (liquid bleach). (TB MED 577)

echelon

Separate level of command. (ADRP 1-02)

executive agent

A term used to indicate a delegation of authority by the Secretary of Defense or Deputy Secretary of Defense to a subordinate to act on behalf of the Secretary of Defense. (JP1-0)

fresh water

Fresh water is untreated water in or taken from a natural source such as a lake, stream, river, spring, or well that has a TDS concentration of less than 1,500 mg/L. (TB MED 577)

***hypo-chlorination**

The application of a hypo-chlorinator to feed calcium or sodium hypochlorite.

***influent**

Water flowing into a reservoir, basin, or treatment operation.

mineral

A naturally occurring, homogenous, inorganic, crystalline substance. (TM 3-34.61)

Non-potable water

In general, water that is not safe to drink. In the operational environment, water from any source that has not been approved by preventive medicine or another local medical authority for use as drinking water. (TB MED 577)

palatable water

Water that is cool, aerated, significantly free from color, turbidity, taste, and odor, and is generally pleasing to the sense. Palatable water is not necessarily potable and may contain disease- or illness-causing substances. (TB MED 577)

potable water

Water that has been tested and approved by preventive medicine personnel to meet the short-term potability or long-term potability standards, and is therefore considered safe to drink for the period that the standards apply to. Potable water may or may not be palatable. (TB MED 577)

raw water

Fresh or sea water that has not been previously used, treated, or purified. (TB MED 577)

supply point distribution

A method of distributing supplies to the receiving unit at a supply point, railhead, or truckhead. (FM 4-40)

throughput distribution

A method of distribution which bypasses one or more intermediate supply echelons in the supply system to avoid multiple handling. (ATP 4-11)

treated water

Water that has passed through unit processes such as coagulation, flocculation, sedimentation, filtration, reverse osmosis, and disinfection. Having been treated does not ensure potability, and it must be inspected by preventive medicine personnel and approved by the command surgeon before it is considered potable. (TB MED 577)

unit distribution

A method of distributing supplies by which the receiving unit is issued supplies in its own area, with transportation furnished by the issuing agency. (FM 4-40)

water quality

The chemical, physical, radiological, and micro-biological characteristics of water with respect to its suitability for a particular purpose. (TB MED 577)

water table

The upper surface of a zone of saturation. (TM 3-34.61).

References

REQUIRED PUBLICATIONS

These documents must be available to intended users of this publication.

ADRP 1-02. *Operational Terms and Military Symbols*. 2 February 2015.

JP 1-02. *Department of Defense Dictionary of Military and Associated Terms*. 8 November 2010.

MCRP 5-12C. *Marine Corps Supplement to the Department of Defense Dictionary of Military and Associated Terms*. 23 July 1998.

RELATED PUBLICATIONS

These documents contain relevant supplemental information.

JOINT PUBLICATIONS

Most joint and Department of Defense publications are available online:

http://www.dtic.mil/doctrine/new_pubs/jointpub.htm

JP 1-0. *Joint Personnel Support*. 24 October 2011.

JP 4-03. *Joint Bulk Petroleum and Water Doctrine*. 9 December 2010.

ARMY PUBLICATIONS

Most Army doctrinal publications are available online: <http://www.apd.army.mil>.

ADRP 3-0. *Unified Land Operations*. 16 May 2012.

AR 700-136. *Tactical Land Based Water Resources Management*. 5 June 2009.

ATP 4-11. *Army Motor Transport Operations*. 5 July 2013.

ATP 4-25.12. *Unit Field Sanitation Teams*. 30 April 2014.

FM 4-02.17. *Preventive Medicine Services*. 28 August 2000.

FM 4-40. *Quartermaster Operations*. 22 October 2013.

FM 27-10/MCRP 5-12.1A. *The Law of Land Warfare*. 18 July 1956.

STP 10-92W14-SM-TG. *Soldier's Manual and Trainer's Guide, MOS 92W, WATER TREATMENT SPECIALIST, SKILL LEVELS 1, 2, 3, and 4*. 20 November 2005.

TC 4-02.3. *Field Hygiene and Sanitation*. 6 May 2015.

TB MED 577/NAVMED P-5010-10/AFMAN 48-138_IP. *Sanitary Control and Surveillance of Field Water Supplies*. 1 May 2010.

TM 3-34.49/NTRP 4-04.2.13/AFMAN 32-1072. *Water-Well Drilling Operations*. December 2008.

Also available online at: <https://ndls.nwdc.navy.mil>.

TM 3-34.61. *Geology*. 12 February 2013.

UNITED STATES LEGAL DOCUMENTS

A searchable version of the U.S. Code is found online at <http://uscode.house.gov>.

Title 10 U. S. Code. *Armed Forces*. 10 August 1956.

OTHER PUBLICATIONS

Most DOD Directives are available online: <http://www.dtic.mil/whs/directives/index.html>.

DOD Directive 4705.01E. *Management of Land-Based Water Resources in Support of Contingency Operations*. 3 June 2015.

Most NATO STANAGs are available online: <http://nso.nato.int/nso>.

References

STANAG 2136. *Requirements For Water Potability During Field Operations and in Emergency Situations*. 21 March 2014.

STANAG 2885. *Emergency Supply of Water in Operations*. 13 January 2010.

WEB SITES

Army Equipping Enterprise System Web site: <https://afm.us.army.mil/>

Army Geospatial Center Web site: <http://www.agc.army.mil>.

Army Publishing Directorate Web site: <http://www.apd.army.mil>.

Operational Logistics Planner Web site:

<https://www.cascom.army.mil/private/cdi/fdd/multi/pdb/oplogplanner.htm>

Force Management System Web site: <https://fmsweb.army.mil/>.

Quartermaster Corps Petroleum and Water Department Web site:

http://www.quartermaster.army.mil/pwd/pwd_main.html

PRESCRIBED FORMS

Unless otherwise indicated, DA Forms are available on the Army Publishing Directorate (APD) web site: www.apd.army.mil.

DA Form 1712. Water Reconnaissance Report.

DA Form 1713. Daily Water Production Log-ROWPU.

DA Form 1713-2. Daily Water Production Log-TWPS.

DA Form 1713-3. Daily Water Production Log-LWP.

DA Form 1714. Daily Water Issue Log.

DA Form 1714-1. Daily Water Distribution Log.

DA Form 1716. Water Point Daily Production Summary.

REFERENCED FORMS

Unless otherwise indicated, DA Forms are available on the Army Publishing Directorate (APD) web site: <http://www.apd.army.mil>.

DA Form 1711. Engineer Reconnaissance Report.

DA Form 2028. Recommended Changes to Publications and Blank Forms.

DOEHRS forms are available on the DOEHRs web site:

<https://mesl.apgea.army.mil/mesl/doehrsResources/initialize.do>.

DOEHRS Water Container Inspection Survey.

DOEHRS Water Treatment System Inspection Survey.

Index

A
Army geospatial center, 1-3
Army materiel command, 1-4
Army medical department, 1-3
assistant secretary of the Army for
acquisition, logistics, and
technology, 1-3

B
bulk water, 1-1

C
computations for water support
operations, C-1
consumption requirements, 2-2

D
defense logistics agency, 1-3
deployment planning, 2-9
disinfection, 4-14

E
engineer well drilling units, 3-7
environmental planning
considerations, 2-3
environmental stewardship, 4-19
expeditionary water distribution
system (Marine Corps), 5-7
extreme weather conditions, 4-18

F
filtration, 4-8

forward area water point supply
system, 5-5

H
hippo, 5-5

I
integrated logistics support center,
1-4

L
lightweight water purification
system (Marine Corps), 4-23
lightweight water purification
system increased production
module (Marine Corps), 4-25
lightweight water purifier, 4-20

M
man-made wells, 3-7
minimum water consumption, A-1

O
ocean intake structure system, 3-9
offshore intakes, 3-9
operator water treatment planning,
4-17

P
packaged water, 1-2

R
reverse osmosis, 4-9

reverse osmosis water purification
unit, 4-22

S
saltwater wells, 3-9
sustaining water consumption, A-1

T
tactical water distribution system,
5-4
tactical water purification system,
4-21
tactical water purification system
(Marine Corps), 4-25
tank-automotive and armaments
lifecycle management
command, 1-4

U
unit water pod system (camel II),
5-6

W
water buffalo, 5-6
water planning tools, 2-1
water reconnaissance, 2-4
water site development, 3-1
water six container system
(Marine Corps), 5-7
water storage and distribution
system, 5-2
water treatment, 4-8

This page intentionally left blank.

ATP 4-44 (FM 10-52, FM 10-52-1, FM 10-115)
MCRP 3-17.7Q
2 October 2015

By Order of the Secretary of the Army

MARK A. MILLEY
General, United States Army
Chief of Staff

Official:



GERAL B. O'KEEFE
Administrative Assistant to the
Secretary of the Army
1526104



K.J. GLUECK, JR.
Lieutenant General, U.S. Marine Corps
Deputy Commandant for Combat
Development and Integration

DISTRIBUTION:

Active Army, Army National Guard, and United States Army Reserve: Distributed in electronic media only (EMO).

