

MCRP 3-20F.9
(Formerly MCRP 3-25.10A)

Low Altitude Air Defense (LAAD) Gunner's Handbook



U.S. Marine Corps

DISTRIBUTION STATEMENT A: Approved for public release; distribution is unlimited.

PCN 144 000092 00

DEPARTMENT OF THE NAVY
Headquarters United States Marine Corps
Washington, D.C. 20350-3000

4 April 2018

CHANGE 1 to MCRP 3-20F.9
Low Altitude Air Defense (LAAD) Gunner's Handbook

1. This publication has been edited to ensure gender neutrality of all applicable and appropriate terms, except those terms governed by higher authority. No other content has been affected.
2. File this transmittal sheet in the front of this publication.

Reviewed and approved this date.

BY DIRECTION OF THE COMMANDANT OF THE
MARINE CORPS

A handwritten signature in black ink, reading "Robert S. Walsh". The signature is written in a cursive, flowing style with a prominent initial "R".

ROBERT S. WALSH

Lieutenant General, U.S. Marine Corps
Deputy Commandant for Combat Development and Integration

Publication Control Numbers:

Publication: 144 000092 00

Change: 144 000092 01

CD&I (C 116)

2 May 2016

ERRATUM

to

MCRP 3-25.10A

LOW ALTITUDE AIR
DEFENSE (LAAD) GUNNER'S HANDBOOK

1. Change all instances of MCRP 3-25.10A, *Low Altitude Air Defense (LAAD) Gunner's Handbook*, to MCRP 3-20F.9, *Low Altitude Air Defense (LAAD) Gunner's Handbook*.
2. File this transmittal sheet in the front of this publication.

PCN 144 000092 80

DEPARTMENT OF THE NAVY
HEADQUARTERS UNITED STATES MARINE CORPS
WASHINGTON, D.C. 20380-1775

9 May 2011

FOREWORD

Marine Corps Reference Publication (MCRP) 3-25.10A, *Low Altitude Air Defense (LAAD) Gunner's Handbook*, complements and expands on the information in Marine Corps Warfighting Publication 3-25.10, *Low Altitude Air Defense Handbook*, by providing information on tactics, techniques, procedures, and employment of the Stinger weapon system for the low altitude air defense (LAAD) gunners. This MCRP is primarily a reference guide for the LAAD section leader, the LAAD firing team leader, and the LAAD gunner (military occupational specialty 7212).

This publication supersedes MCRP 3-25.10A, *Low Altitude Air Defense (LAAD) Gunner's Handbook*, dated 6 November 2000.

Reviewed and approved this date.

MCRP 3-25.10A

BY DIRECTION OF THE COMMANDANT OF THE MARINE
CORPS

A handwritten signature in black ink, appearing to read 'George J. Flynn', with a long horizontal line extending to the right.

GEORGE J. FLYNN

Lieutenant General, U.S. Marine Corps
Deputy Commandant for Combat Development and Integration

DISTRIBUTION: 144 000092 00

DISTRIBUTION STATEMENT A: Approved for public release;
distribution is unlimited.

Table of Contents

Chapter 1. Fundamentals

Maneuver Warfare	1-1
Low Altitude Air Defense Mission	1-1
Organization	1-2
Command and Control	1-3
Command and Support Relationships	1-4
General Support	1-5
Direct Support	1-6
Assignment and Attachment	1-7
Considerations	1-7
Other Authorities	1-8

Chapter 2. Weapons Systems

Stinger Weapon System	2-1
Missile Components	2-1
Stinger Weapon Round	2-3
Transportation Containers	2-7
Stinger Handling Procedures	2-9
Weapons Checks	2-10
Missile Firing Procedures	2-14
Post Firing Procedures	2-24
Stinger Hang Fire, Misfire, and Dud Procedures	2-25
Destroying the Stinger Missile	2-26
Safety Distances	2-28
Nature of Infrared Radiation	2-29
Atmospheric Conditions	2-30

MCRP 3-25.10A

Advanced Man-Portable Air Defense System. 2-31

Medium Machine Gun,
7.62mm, M240B (Crew-Served Weapon). 2-31

 Mounting the Weapon 2-32

 Changing the Barrel 2-33

 Defining a Hot Barrel 2-34

 Stoppages and Malfunctions. 2-35

 Ammunition 2-38

Heavy Machine Gun,
.50 cal, M2 (Crew-Served Weapon) 2-41

 Mounting the Weapon 2-42

 Head Space and Timing 2-42

 Stoppages and Malfunctions. 2-43

 Ammunition 2-47

Chapter 3. Employment

Air Defense Priorities 3-2

Air Threats Facing the Marine Air-Ground Task Force 3-3

 Fixed-Wing Attacks 3-3

 Helicopter Attacks 3-6

Air Defense Employment Principles. 3-6

 Mass 3-7

 Mix 3-7

 Mobility 3-7

 Integration. 3-8

Low Altitude Air Defense Employment Guidelines 3-8

 Balanced Fires 3-8

 Early Engagement 3-9

Weighted Coverage	3-10
Mutual Support	3-10
Defense in Depth	3-12
Overlapping Fires	3-12
Considerations for Low Altitude Air Defense Team Positions	3-13
Observation and Fields of Fire	3-14
Accessibility	3-15
Security from Ground Attack	3-15
Low Altitude Air Defense Team Tactical Positions	3-16
Primary Position	3-16
Alternate Position	3-17
Initial Tasks	3-17
Alerting and Cueing	3-20
Cartesian Coordinate Grid	3-21
Polar Coordinate Reference	3-23
Polar Grid	3-24
Visual Detection of the Target	3-25
Terrain Masking and Meteorological Conditions	3-25
Aircraft Recognition Characteristics	3-25
Visual Acuity	3-26
Search Sector	3-27
Horizontal Scanning	3-28
Vertical Scanning	3-29
Nonsystematic Search Methods	3-30
Scanning Tips	3-30
Where to Search	3-30
Aircraft Interrogation Techniques	3-31
Aircraft Identification	3-31

MCRP 3-25.10A

Engagement Process	3-31
Decision	3-31
Techniques of Fire	3-36
Methods of Engagement	3-39
Engagement Sequence	3-40
Rules of Engagement.	3-43
Right of Self-Defense	3-44
Target Identification Criteria	3-44
Weapon Control Status	3-47
Air Defense Warning Conditions	3-47
Air Defense States of Alert	3-48
Fire Control Orders	3-50
Ingress, Egress, and Return to Force Control Procedures.	3-52
Base Defense Zone Procedures	3-52
Marine Air Traffic Control Detachment	
Low Altitude Air Defense Integration	3-53
Command and Control	3-54
Ingress or Egress Control Procedures.	3-54
Chemical, Biological, Radiological, and Nuclear Operations.	3-55
Mission-Oriented Protective Posture	3-57
Immediate Action	3-57
Subsequent Action	3-58
Chemical, Biological, Radiological, and Nuclear Alarms	3-58
Unmasking	3-59
Nuclear, Biological, and Chemical-1 Report	3-59

Chapter 4. Training

Individual Training 4-1

Formal Schools 4-2

 On-the-Job Training 4-2

 Weapons, Tactics, and Instructor Course 4-2

 Low Altitude Air Defense
 Enhancement Training Course 4-3

Stinger Training Equipment 4-3

 Field Handling Trainer 4-3

 Tracking Head Trainer 4-4

 Stinger Troop Proficiency Trainer 4-6

 Stinger Improved Moving Target Simulator 4-7

 Stinger Launch Simulator 4-8

Platoon, Section, and Team Training 4-9

 Platoon Training 4-9

 Section Training 4-9

 Team Training 4-9

Aircraft Identification Training 4-10

Unit Training 4-11

Evaluating Training 4-12

Terrain Walk 4-12

Terrain Model Exercise 4-12

Crew Drills 4-13

Chapter 5. Support Equipment

Advanced Man-Portable Air Defense System 5-1

Identification, Friend or Foe Subsystem 5-1

MCRP 3-25.10A

Remote Terminal Unit5-3

AN/PSN-13 Defense Advanced
Global Positioning System Receiver5-4

Optical Devices5-6

AN/PAS-18, Receiver, Infrared System5-6

AN/PVS-7B, Night Vision System.5-7

AN/PVS-14, Monocular Night Vision Device5-8

AN/PAS-13, Thermal Weapon Sight5-9

Communications Equipment5-10

AN/VRC-91D, Man-pack/Vehicular Radio Set5-10

AN/MRC-148, High Frequency Vehicular Radio5-11

AN/PRC-150, High Frequency Man-pack Radio5-12

AN/PRC-117F(V)1C,
Radio Set, Multi-band, Falcon II5-13

AN/PRC-119 (A-F), Single-Channel Ground
and Airborne Radio System Man-pack Radio5-14

AN/VRC-110, Dual Vehicular Adapter5-15

AN/PRC-152, Tactical Hand-held Radio5-16

OK-648/U, Control Group Radio5-17

RF-5800R-RC111, Remote Control System5-18

AN/GRA-39, Radio Terminal Set5-19

TA-312/PT, Telephone Set.5-20

Communications Security Equipment5-21

AN/CYZ-10, Data Transfer Device5-21

AN/PYQ-10, Simple Key Loader.5-22

Antennas5-24

AS-2259/GR, Antenna5-24

OE-254/GRC, Antenna.5-24

Appendices

A	Low Altitude Air Defense Status Board	A-1
B	Low Altitude Air Defense Team Mount-Out Guide.	B-1
C	Operational Reports, Requests, and Orders	C-1
D	Operational Communications	D-1
E	Stinger Support Equipment	E-1
F	Identification, Friend or Foe Equipment.	F-1
G	Remote Terminal Unit	G-1
H	AN/PSN-13 Defense Advanced Global Positioning System Receiver	H-1

Glossary

References

Chapter 1

Fundamentals

MANUEVER WARFARE

Marine Corps combat doctrine is based on maneuver warfare. Maneuver warfare is characterized by the concentration of forces at a decisive time and place, speed of action, surprise, boldness, and the exploitation of enemy vulnerabilities.

The lightweight, mobile Stinger antiaircraft missile enables the low altitude air defense (LAAD) units to support maneuver warfare. The LAAD's ability to task-organize, coupled with the Stinger's inherent mobility and flexibility, give the Marine air-ground task force (MAGTF) a maneuver-oriented air defense capability that can support all types of tactical operations.

LOW ALTITUDE AIR DEFENSE MISSION

The LAAD's primary mission is to support the MAGTF commander by providing close in, low altitude, surface-to-air weapons fires in defense of MAGTF assets by defending forward combat areas, maneuver forces, vital areas, installations, and/or units engaged in special/independent operations.

The LAAD's secondary mission is to provide a task-organized, ground security force in defense of MAGTF vital areas, installations, and/or units engaged in special/independent operations.

ORGANIZATION

The firing team is the LAAD battalion’s basic combat unit (see fig. 1-1). It consists of a team leader/vehicle commander and assistant gunner/driver. All team members are trained as gunners, drivers, and radio operators to effectively perform target detection, aircraft recognition, armor recognition, and machine gun employment. Normally, the assistant gunner/driver will fire the Stinger missile(s), allowing the team leader to evaluate targets and make engagement decisions. During periods of intense enemy air activity, both team members may act as gunners to increase the rate of fire. There are multiple variations of LAAD teams and their combat loads may be altered according to the mission and role assigned to their team. The fire unit normally deploys using the advanced man-portable air defense system (A-MANPADS) vehicle. Each fire team carries a basic load of two weapon rounds and two missile rounds (some vehicle variants can only carry three missiles on the missile rack). Dismounted teams normally carry a basic load of one weapon round per team member.

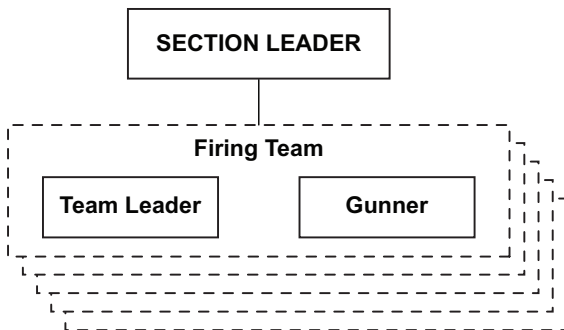

Figure 1-1. Low Altitude Air Defense Section Organization.

COMMAND AND CONTROL

The LAAD section leader commands and controls firing teams through established rules of engagement (ROE) and detailed procedures. Because teams are usually located far from the section leader's command post, direct and personal supervision is not normally possible. Fire unit leaders must possess a strong sense of responsibility and, once their firing position is established, must realize the importance of providing accurate information to the chain of command. Though there is no formalized method to maintain information on unit statuses, the LAAD status board has been developed as a tool to assist section leaders (see app. A).

Low altitude air defense units must integrate with the Marine air command and control system (MACCS) to facilitate operation of an integrated air defense system (IADS). Section leaders need a firm understanding of LAAD integration with the tactical air operations center (TAOC). See Marine Corps Warfighting Publication (MCWP) 3-22, *Antiair Warfare*; MCWP 3-25.10, *Low Altitude Air Defense Handbook*; and MCWP 3-25, *Control of Aircraft and Missiles*, for more information.

The LAAD section leaders must know the location of their teams at all times and periodically provide the direct air support center (DASC) and/or the supported unit's fire support coordination center (FSCC) with position updates. The team may need to displace frequently to properly defend a maneuvering unit and to ensure its survivability. These factors can make it difficult for the section leader to know team locations. However, the DASC and/or FSCC must be kept informed of the location of the LAAD units so that the teams do not unknowingly enter free-fire areas or establish positions

where they are exposed to friendly fires. This is particularly important when LAAD units are assigned a general support mission, and their movement is not associated with the maneuver of any one particular unit or organization.

COMMAND AND SUPPORT RELATIONSHIPS

Command relationships establish authority, responsibility, and a chain of command. A command relationship specifies the degree of authority one commander has over another commander. The purpose of a command relationship is to give commanders authority and assets to accomplish their assigned missions.

Support is a command authority. A support relationship is established by a superior commander between subordinate commanders when one organization should aid, protect, complement, or sustain another force while maintaining the normal chain of command. For example, a commander may direct a LAAD unit to be in direct support of a Marine regiment. The LAAD unit commander can accomplish his/her mission and still maintain the normal chain of command within the battalion. The MAGTF commander approves or directs support relationships between the ground combat element and the aviation combat element. The MAGTF commander also establishes MAGTF air defense priorities before LAAD assets are given support missions. A support relationship does not necessarily imply that logistic or administrative support is automatically provided to the supporting LAAD unit. This responsibility is retained by the commander exercising administrative control. Units establish support relationships with or without being assigned or attached to the supported unit. The two standard support relationships are general support and direct support.

General Support

General support is given to the supported force as a whole and not to any subdivision. General support considerations include—

- Air defense priorities are established based on the needs of the entire force.
- Supporting units are not associated with maneuvering of any particular subelement of the larger force as this may leave a gap in air defense coverage.
- LAAD units maintain communications with the MACCS to ensure that critical information is distributed to all levels within the IADS. The coordination for LAAD units in general support should consist of security, coordination with adjacent units, distribution of early warning information, advising units on passive defense, and small arms defense from air attack.
- Logistic needs such as resupply of missiles, food, fuel, and maintenance support are provided by the LAAD battalion or battery headquarters and services detachment via the chain of command. Timely resupply may be difficult, since LAAD sections are normally dispersed widely throughout the operations area. When possible, support is received from adjacent or supported units to ensure timely receipt of critical resupply. In order for this to take place, the battalion must plan, coordinate, and follow up with the section providing the support.
- Security from ground attack is coordinated with the supported unit. The senior LAAD representative should conduct as a liaison with the commander in whose zone of action (ZOA) they are operating in to ensure that the support unit is aware of the LAAD elements moving through or operating within their ZOA.

Direct Support

Direct support is given by one force to another force requiring the supporting force to answer directly to the supported unit commander's request for assistance. Direct support considerations include—

- The supporting unit is immediately responsive to the supported unit's requirements.
- The supported unit establishes local air defense priorities.
- The LAAD elements operate within supported unit's ZOA or sector.
- The LAAD elements accompany the supported unit to maintain coverage of the established air defense priorities.
- The LAAD elements maintain communications with the supported unit to receive critical information such as modifications to ROE, early warning, cueing, and essential intelligence or coordinating instructions.
- The LAAD elements must coordinate local security requirements. Security is not always provided in direct support. The LAAD elements may be directed to augment local security. The senior LAAD representative should brief the supported unit commander on possible diminished quality of air defense provided by a nonrested crew. The supported unit commander should determine the priority for air defense versus perimeter security. This coordination should also provide LAAD units with proper procedures for maneuvering throughout the supported unit's ZOA.

- With a unit providing direct support, the parent LAAD unit may find it difficult to provide logistic support due to the greater distances between units. When possible, LAAD commanders should coordinate logistics through the supported unit.
- The LAAD units must maintain communications with the MACCS to operate as part of the IADS whenever possible to allow LAAD teams to receive early warning and cueing information.

Assignment and Attachment

An assignment or attachment is a transfer of forces. A LAAD unit can be assigned or attached to another unit under an operational control or tactical control status.

An assignment is the placement of a unit or personnel into an organization outside the normal chain of command, where such placement is relatively permanent. A LAAD section deploying with a Marine expeditionary unit is an example of an assignment.

An attachment is the temporary placement of a unit or personnel into an organization outside the normal chain of command. For example, LAAD units would be used as an attachment in independent operations such as a noncombatant evacuation operation, helicopterborne assaults, or raid.

Considerations

The degree of administrative control exercised over LAAD units will be specified in the assignment or attachment directive. This

determines who is responsible for the administrative and logistic needs of the LAAD unit.

If possible, the attached LAAD unit will maintain communications with MACCS for cueing, early warning, and updated weapons conditions. Assignment or attachment directives will state the limits of authority in terms of establishing air defense control measures when applicable.

Other Authorities

In addition to command relationships, LAAD units can be placed under other areas of authority. These authorities are described in the following paragraphs.

Administrative control is the direction or exercise of authority over subordinate or other organizations with respect to administration and support. This authority includes control of resources and equipment, organization, personnel management, unit logistics, individual and unit training, readiness, mobilization, demobilization and discipline, and other matters not included in the operational missions of the subordinate or other organizations. The degree of administrative control may be delegated by the MAGTF commander or parent unit commander and exercised at any echelon at or below the delegating authority.

Direct liaison authorized (DIRLAUTH) is the authority granted by a commander (any level) to a subordinate in order to directly consult or coordinate an action with a command or agency within or outside of the granting command. The DIRLAUTH, which is more applicable to planning than operations, carries the additional requirement of keeping the commander informed. The DIRLAUTH is a coordination relationship, not an authority through which command may be exercised.

Operations in a specific ZOA are another area where LAAD units may be placed under authority. The commander of a sector or ZOA in which LAAD units are operating has some degree of authority over those LAAD units in regard to movement and security requirements, unless the LAAD unit commander is exempt from such authority. For LAAD elements to negotiate safely through or operate in a specific ZOA, the element must coordinate security, movement, fire unit placement, and missile firing with the controlling unit. In addition, LAAD elements must coordinate personnel security requirements and address possible security requirements that they may have been tasked to provide for that ZOA. See Marine Corps Reference Publication 3-25E, *Multi-Service Tactics, Techniques, and Procedures for an Integrated Air Defense System (IADS)*, for more information.

Chapter 2

Weapons Systems

STINGER WEAPON SYSTEM

The basic Stinger weapon is a Marine-portable, shoulder-fired, infrared (IR) radiation homing (heat-seeking) guided missile that requires no control from the gunner after firing. Stinger provides short-range air defense (SHORAD) to counter high-speed, low-level, and ground attack aircraft. Stinger has an identification, friend or foe (IFF) subsystem that aids the gunner and team leader in identifying friendly aircraft. The reprogrammable microprocessor (RMP) Stinger operates the same way as the basic Stinger except for its improved tracking ability and improved infrared counter countermeasures (IRCCM). The RMP Stinger tracks targets in either IR or negative ultraviolet (NUV). Block 1 improvements provide enhanced capabilities with the roll indicator that allows the missile to compensate for missile tip off and potential gunner error with super-elevation and lead.

Missile Components

The Stinger missile has three main sections: guidance, warhead, and propulsion. Each section can be broken down into subcomponents of the missile (see fig. 2-1 on page 2-2).

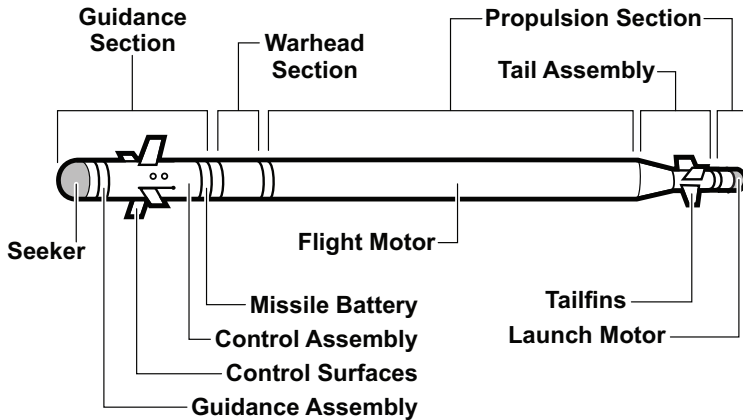

Figure 2-1. Stinger Missile.

Guidance Section

The guidance section consists of a seeker assembly, guidance assembly, control assembly, missile battery, and four control surfaces (wings) that provide in-flight maneuverability. The tail assembly, which is not located with the guidance section, provides stabilization and the beveled leading edges control roll. The guidance assembly processes target IR/NUV and provides guidance commands for the missile during flight. The seeker tracks the IR or NUV source automatically after the gyro is uncaged and during missile flight. The control assembly converts guidance commands into control surface movement that steers the missile. The battery provides in-flight power. If the temperature is above 100 °F, the IR detector-cell cool down in the RMP Stinger may take up to 5 seconds. The seeker will attempt to reacquire the target through NUV during the cooling process. The forward cover (lollypop) should remain on the missile covering the seeker to

protect it from damage and from the direct sun light. Exposing the seeker to the sun for a long period of time may cause the seeker to become super-saturated (overheated) and take an additional period of time for the seeker to cool off once activated.

Warhead Section

The warhead section consists of a fuse assembly with an equivalent of 1 lb of high explosives (HTA-3) encased in a pyrophoric, titanium cylinder. The fuse is extremely safe and makes the missile exempt from any hazards of electromagnetic radiation to ordnance conditions. Target impact or self-destruction detonates the warhead. Self-destruction occurs 15 to 19 seconds after the launch. Missile safety features make it safe for shipping and handling.

Propulsion Section

The propulsion section consists of a launch motor and a dual thrust flight motor. The launch motor ejects the missile from the launch tube. The missile coasts a safe distance (about 9 meters or 29 ft) from the gunner before the flight motor ignites. A sustained flight phase maintains missile velocity until the propellant is consumed and the missile then enters the coast phase, maintaining maneuverability until intercept or self-destruction.

Stinger Weapon Round

The Stinger weapon round consists of a missile round, a separable gripstock, and a battery coolant unit (BCU) (see fig. 2-2 on page 2-4). If the RMP Stinger weapon round is handled roughly after activation and the gyro is knocked off center, the gyro may take up to 15 seconds to realign.

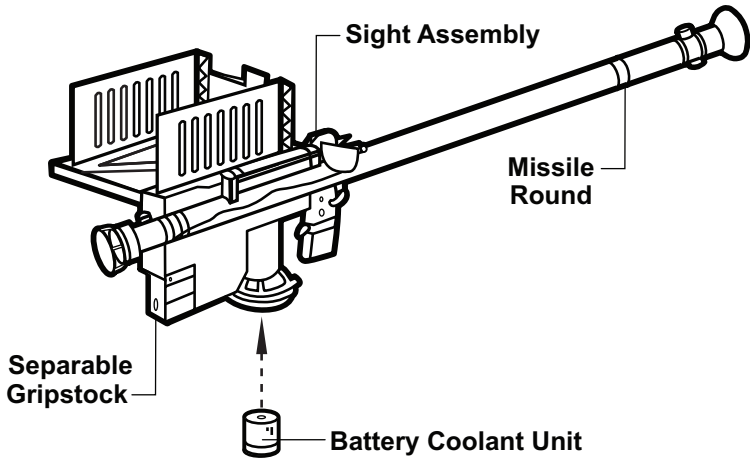

Figure 2-2. Stinger Weapon Round.

Missile Round

The missile round consists of a Stinger missile sealed in a launch tube with an attached sight assembly (see fig. 2-3).



Figure 2-3. Missile Round.

The fiberglass launch tube provides the main support for all parts of the launcher. Both ends of the launch tube are sealed with breakable disks. On the basic Stinger missile, the IR window (front disk) is transparent to IR and is opaque. On the RMP and Block 1 Stinger missile, the IR window is clear and transparent to both IR and ultraviolet radiation. Both the IR window (front) and the blowout disk (rear) break when the missile is fired. This creates a hazard because of the flying glass; eye protection is recommended for the team leader when firing the missile. A desiccant cartridge/humidity indicator on the launch tube indicates whether moisture has entered the tube. Green indicates the launch tube is moisture-free and safe to fire. Tan indicates possible exposure to moisture, and the missile should not be used. If the desiccant cartridge is tan, it must be replaced. After 24 hours, check the desiccant cartridge again for moisture contamination. If the desiccant cartridge turns tan again, the missile round must be returned to the missile resupply point.

The sight assembly allows the gunner to acquire range and track an aircraft. Two acquisition indicators are mounted on the sight assembly. A speaker allows the gunner to hear the IFF tones and IR acquisition signal, while a bone transducer allows the gunner to “feel” the IR acquisition signal. The clear plastic eye shield protects the gunner’s left eye during firing. The open sight is used to aim the weapon and visually track the target and consists of a front sight with a range ring, a sight aperture with three open reticles, and a rear peep sight. The range ring is used to determine if the aircraft is in range and provides visual tracking of the target. The rear sight reticles are used to insert super-elevation and lead angle. Super-elevation is an additional elevation angle that overcomes the effects of gravity on the missile. Lead is applied to assist the missile on its flight path to the target and is applied to all targets except directly incoming or outgoing fixed-wing aircraft. The peep sight is located at the rear of the sight. The gunner uses the peep sight to properly align the other sight elements.

Gripstock

The gripstock consists of the gripstock assembly and the IFF antenna assembly and contains all of the circuits and components required to prepare and launch the missile. After the missile is launched, the gripstock is removed from the launch tube for reuse. When the IFF antenna assembly is unfolded and the IFF interrogator is connected to the weapon, the gunner can interrogate aircraft and receive coded replies. The RMP missile round can be used with a basic gripstock, but the resulting weapon round will function as a Stinger post weapon round. A basic missile round with an RMP gripstock will function as a basic weapon round. The basic gripstock does not have a security classification, but is considered a sensitive piece of equipment that must be secured when not under direct control. The RMP gripstock is classified as confidential when equipped with the RMP missile. It is engineered to function without failure a minimum of 25 times. The LAAD battalions will dictate proper usage and destruction procedures in accordance with unit standing operating procedures (SOPs).

Battery Coolant Unit

The BCU contains a thermal battery that provides power for preflight system operations and a supply of argon gas to cool the missile seeker's IR detector. Once activated, the BCU supplies electric power and argon gas for a maximum of 45 seconds or until the missile is launched. The safety and actuator device must be in the safe position before the BCU is inserted. The Stinger weapon is shipped with a cap covering the BCU receptacle; the cap remains in place until just before BCU insertion. The receptacle cap is removed by turning it counterclockwise and then placing it in the BCU container (within the shipping and storage container) for future use. Prior to inserting a BCU, the gunner should ensure that the color of the heat-sensitive

indicator is pink. If not, the BCU is discarded and a new BCU is inserted into the receptacle and turned clockwise until it locks in place. Because the BCU gets extremely hot (400 °F), within 3 to 5 minutes after activation, the gunner should grasp the BCU only by the heat-insulated cap when removing it. The gunner should be made aware of additional safety precautions due to the purging of residual argon gas within the BCU upon removal and remove the BCU immediately after firing.

CAUTION: High pressure gas could cause injury to personnel when discharged from BCU well.

Transportation Containers

Weapon Round Container

The weapon round container is a reusable aluminum box that provides environmental protection for one weapon round and three BCUs during shipping and storage (see fig. 2-4). Inside each container is a set of earplugs. The container has four latches, handles for the two-Marine carry, a pressure relief valve, humidity indicator, and a BCU storage area.

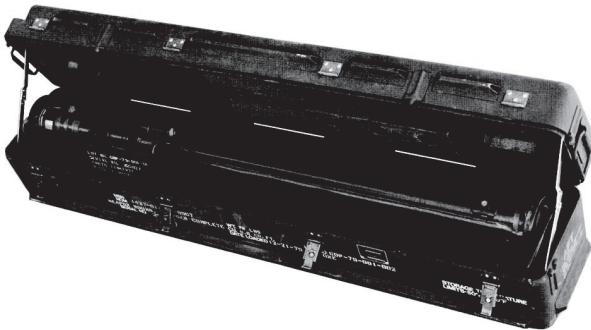

Figure 2-4. Weapon Round Container.

Missile Round Container

The missile round container (MRC) is a wooden box that provides adequate protection for one missile round and two or three BCUs during shipping and storage. It also contains a set of ear-plugs. These items are wrapped in a sealed barrier bag with desiccant for protection against the environment. A humidity indicator is enclosed in the bag to indicate moisture content. The bag is inside a fiberboard liner, which is inside the wooden box (see fig. 2-5). As rounds are expended, the gunner simply opens an MRC, removes the missile round, mates the gripstock assembly from the expended round to the new missile round, and installs a BCU.

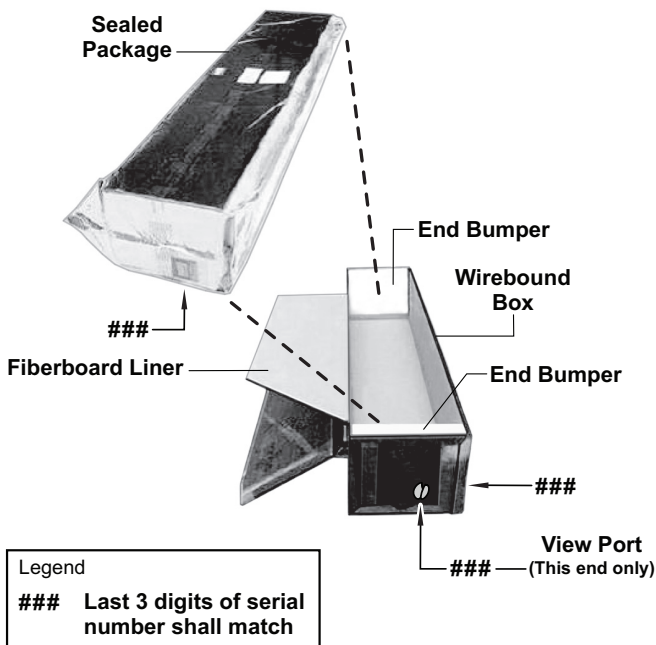

Figure 2-5. Missile Round Container.

Stinger Handling Procedures

When a Stinger weapon round is received from the missile resupply point, the missile is removed from the shipping and storage container and inspected in accordance with the “upon receipt checks” found in Technical Manual (TM) 08319A-12, *Operators and Organizational Maintenance Instructions STLS (Stinger Launch Simulator) NSN 6920-01-119-7619*. The markings on the container are verified to ensure the container holds a live round. A live round container is identified with yellow squares on the container's two diagonally, opposite corners and yellow data markings. Training rounds are marked with blue squares, tracking head trainer (THT) with bronze squares, field handling trainer (FHT) with white data markings, and the word “INERT” on the top of the case. The Stinger weapon round and IFF interrogator containers are sealed to prevent environmental damage. Before either case is opened, the pressure relief valve must be pressed. When the rushing air noise stops, the internal pressure of the case is the same as the pressure on the outside of the case. The MRC does not have a pressure relief valve. When out of its container, the weapon is carefully rested on its side; do not stand the weapon on its end. If the launch tube does not have the proper color markings—four, 1-inch yellow squares—the trainer is returned to the resupply point and exchanged for another weapon round. The gunner carries the weapon by placing the carrying sling over the shoulder when walking. The weapon is carried horizontally at a slight angle with the sling tight enough to prevent the weapon from swinging. The gunner does not remove the weapon's protective covers (i.e., BCU receptacle, front end, and IFF connector caps) until preparing to fire or for inspection.

Weapon Checks

Although this publication does not cover preventive maintenance checks and services, it does contain an abbreviated set of weapon checks that may be made under field conditions when the time and tactical situation permit. When Stinger missiles are issued and sufficient time is not available to perform all the checks listed in the technical manual, the team leader and gunner must, at a minimum, perform the critical checks. This does not mean that the other checks listed in TM 9-1425-429-12, *Operator's and Organizational Maintenance Manual for Stinger Guided Missile System Consisting of: Weapon Round RMP: FIM-92D (NSN 1425-01-325-0695) (EIC: N/A) (NSN 1425-01-356-6995) (EIC: N/A) (NSN 1425-01-325-0696) (EIC: N/A) Weapon Round Block I: FIM-92E (NSN 1425-01-440-8040) (EIC: N/A) Trainer Handling Guided Missile Launcher M60 (NSN 6920-01-024-9969) (EIC: NRH) Guided Missile Subsystem Intercept-Aerial, Training M148 (NSN 6920-01-246-0699) (EIC: NSC) Interrogator Set AN/PPX-3A, AN/PPX-3B (NSN 5895-01-032-4263) (EIC: IZH) (NSN 5895-01-126-9263) (EIC: IZF) Interrogator Set Programmer AN/GSX-1, AN/GSX-1A (NSN 5895-01-032-4266) (EIC: IZJ) (NSN 5895-01-119-1273) (EIC: IZK)*, should be overlooked if time permits. See FM 44-18-1, *Stinger Team Operations*, for more information.

Full checks are made daily when time and the situation allow and when the team is in a reduced state of alert. Full checks are especially important for weapons that have been out of their containers and exposed to bad weather. TM 9-1425-429-12 provides information on performing a full check.

A well-thought-out and organized procedure for checking the Stinger weapon round will ensure that it will fire when needed. If any item listed is defective, then its entire component is considered not ready or available (see fig. 2-6).

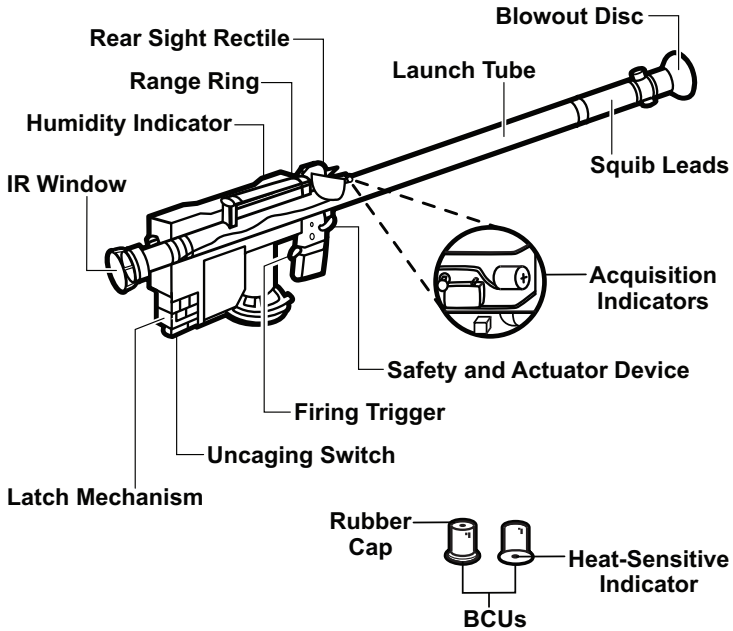

Figure 2-6. Stinger Weapon Round Components.

Missile Round

With the missile round pointed in a safe direction, inspect the missile round for serviceability by performing the following steps:

Step 1: Ensure the blowout disk is not cracked or broken.

Step 2: Ensure the launch motor igniter squib leads are not damaged or broken. (Do not remove the adhesive cover; just run fingers along wires.)

Step 3: Ensure the launch tube is not cracked or broken.

MCRP 3-25.10A

Step 4: Verify the color in humidity indicator window. If tan, replace it at once with green desiccant cartridge. Do not use the missile for 24 hours. If the indicator turns tan again within a 24-hour period, there is too much moisture in the launch tube. Turn missile into a resupply point.

Step 5: Ensure the IR window is clean and not scratched, broken, or cracked. If the window needs cleaning, use a lens cleaning tissue (see paragraph 3-5, TM 9-1425-429-12).

Step 6: Ensure the acquisition indicators and wires are not damaged.

Step 7: Ensure the rear sight reticle is not loose or defective.

Step 8: Ensure the range ring is not loose or defective.

Note: If the paint seals on the screws holding the range ring or rear sight reticle to sight assembly are broken, assume they have been tampered with and do not use the launch tube until the bore sight has been verified.

Gripstock Assembly

Note: Before performing gripstock assembly checks, ensure a BCU is not installed. If a BCU is installed, do not inspect the gripstock assembly and do not remove the BCU. Turn gripstock into the resupply point.

With the missile round pointed in a safe direction, inspect the gripstock assembly for serviceability by performing the following steps:

Step 1: Press and release the lever on the safety and actuator device. After the click is heard, return lever to normal position.

Step 2: Press and release the uncaging switch (located in three positions: center and both ends). A click should be heard each time. Return the switch to the caged position.

Step 3: Squeeze and release the firing trigger. After the click is heard, return the trigger to the normal position.

Step 4: Check the latch mechanism (it holds the gripstock assembly securely to the launch tube).

Battery Coolant Unit

Prior to insertion, inspect the following for BCU serviceability:

Step 1: Check all BCUs. The color of the heat-sensitive indicator should be pink. If not, discard the BCU. Check the holes over the burst disc diaphragm. If the silver foil is ruptured, discard the BCU.

Note: Do not remove an installed BCU to perform the following checks.

Step 2: Inspect rubber cap over needle. If the cap is punctured, use the BCU only in an emergency.

Step 3: Inspect the needle without removing rubber cap. Ensure the needle is not bent. Do not try to straighten bent needle. Discard BCU in accordance with unit SOP.

Step 4: Check BCU housing to ensure that it is not cracked. If so, discard BCU.

Note: Weapon mating procedures are outlined in TM 9-1425-429-12.

Missile Firing Procedures

Warning

When firing, gunner and assistant must hold their breath until trigger is released to avoid inhaling toxic fumes. If an exhaust plume visibly persists at firing position, gunner and assistant must move away from plume before inhaling.

Step 1: Attach the IFF interrogator to the belt and the IFF clamp to the body armor vest (see fig. 2-7).

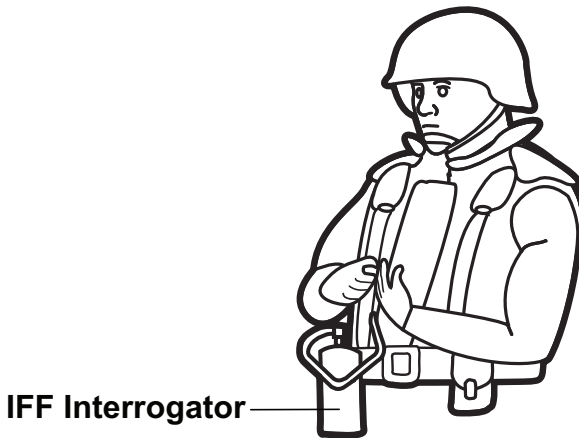

Figure 2-7. Firing Procedures, Step 1.

Step 2: Shoulder the weapon (see fig.2-8).

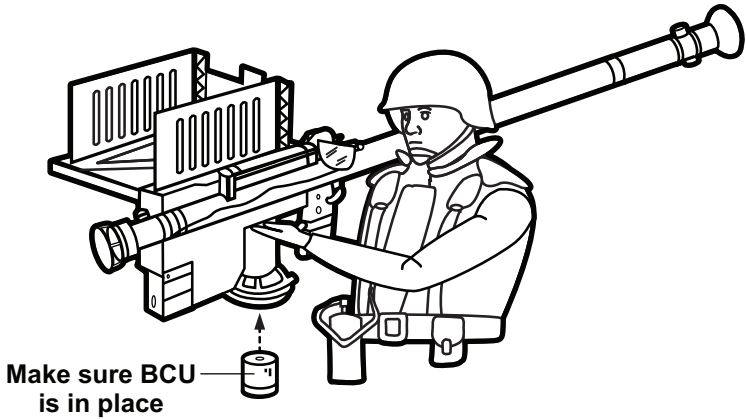

Figure 2-8. Firing Procedures, Step 2.

Step 3: Unfold the antenna, pull up and release (see fig. 2-9).

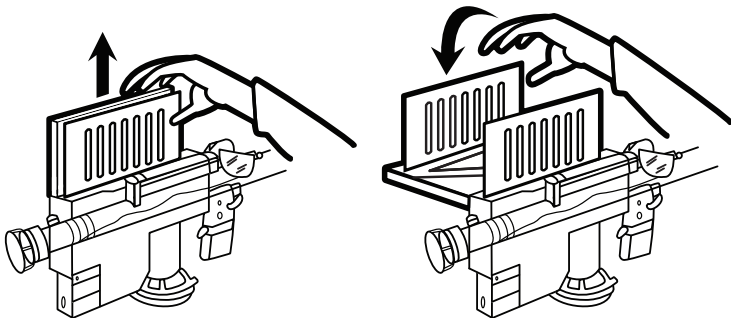

Figure 2-9. Firing Procedures, Step 3.

Step 4: Remove cover (see fig. 2-10).

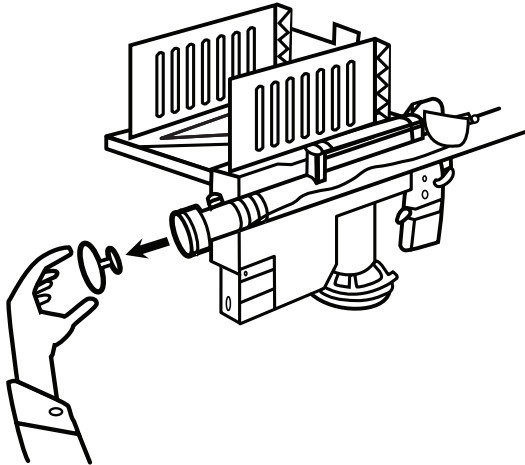

Figure 2-10. Firing Procedures, Step 4.

Step 5: Raise sight assembly (see fig. 2-11).

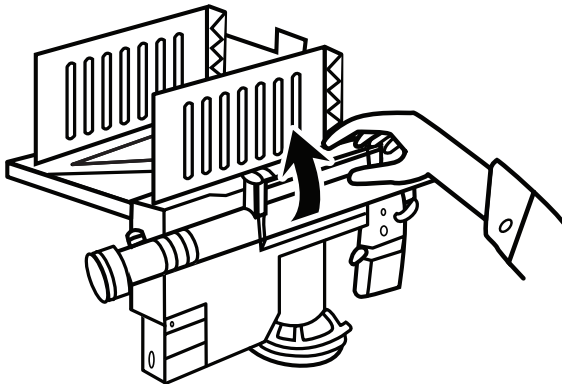

Figure 2-11. Firing Procedures, Step 5.

Step 6: Remove IFF connector from clamp assembly at the protective cover (see fig. 2-12).

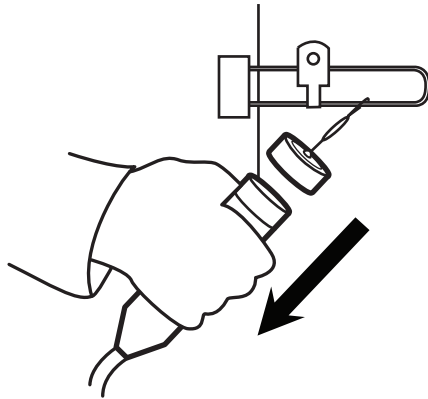

Figure 2-1

Step 7: Remove gripstock protective cover and connect cable (see fig. 2-13)

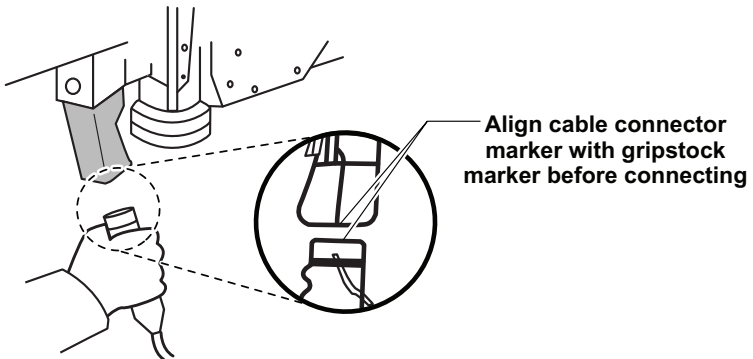

Figure 2-13. Firing Procedures, Step 7.

Step 8: Point weapon at target and center target in range ring (see fig. 2-14).

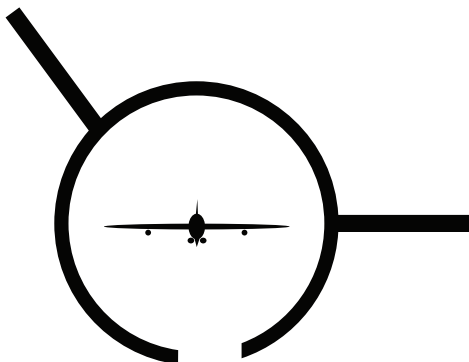

Figure 2-14. Firing Procedures, Step 8.

Step 9: Press IFF interrogator switch (see fig. 2-15). If the target has already been identified, go to step 11.

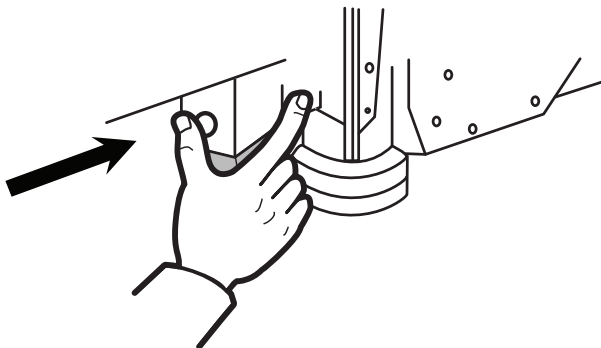

Figure 2-15. Firing Procedures, Step 9.

Step 10: Listen for IFF response (see fig. 2-16).

Note: If the correct Mode IV reply is not received, the interrogator automatically switches to Mode III when programmed using the Mode IV/ III setting and interrogates again. If a Mode III reply is received, a 1 1/2-second beep will sound. If an incorrect reply or no reply is received, a string of short beeps will sound, meaning that the target identity is unknown.

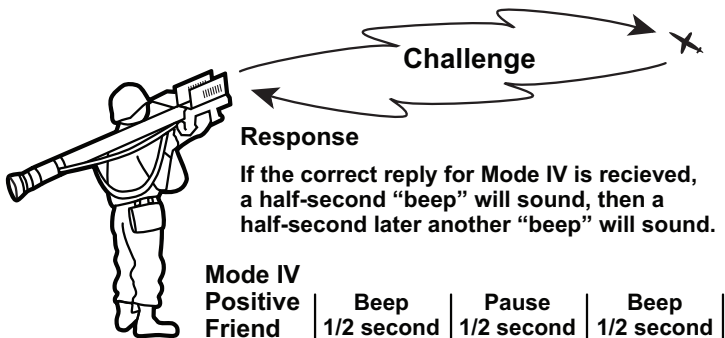

Figure 2-16. Firing Procedures, Step 10.

Step 11: Begin tracking and ranging target (see fig. 2-17).

Note: If no tone is heard when the IFF interrogator switch is pressed, the IFF is either defective or the IFF interrogator is not connected to the weapon.

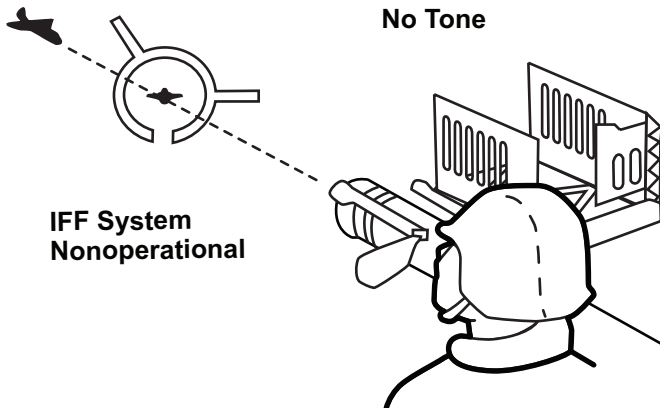
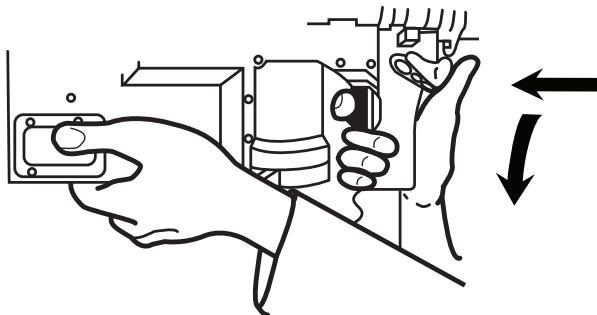

Figure 2-17. Firing Procedures, Step 11.

Step 12: Wait until target is in range (see fig. 2-18).



Step 13: Operate safety and actuator device.

Step 14: Listen for the distinct acquisition tone.

Step 15: Press and hold uncage bar (see fig. 2-19).

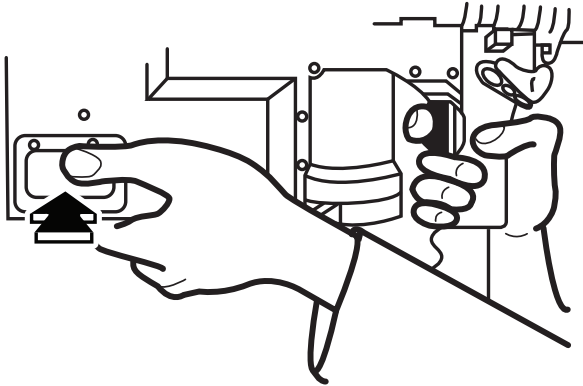
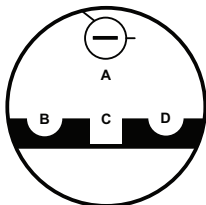
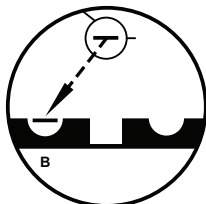

Figure 2-19. Firing Procedures, Step 15.

Step 16: Positively identify aircraft and prosecute in accordance with current weapons control status (WCS) and ROE.



Right Lead Induced (Fixed-Wing)



All fixed-wing aircraft and helicopters coming from and left, or slightly from the left, are placed in the left reticle B.

Left Lead Induced (Fixed-Wing)

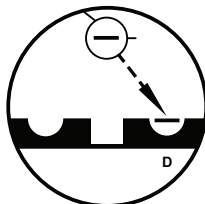

All fixed-wing aircraft and helicopters coming from and right, or slightly from the right, are placed in the right reticle D.

Incoming/Outgoing (Fixed-Wing)

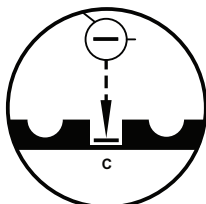

All fixed-wing aircraft directly incoming or outgoing are placed in the center of reticle C.

Helicopters and Hovering V/STOL Aircraft

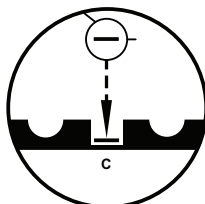

Hovering helicopters and hovering V/STOL aircraft regardless of aspect are placed in the center of reticle C.

NOTE: When firing the RMP Stinger missile, all helicopters and V/STOL aircraft, regardless of aspect, are placed in the center reticle.

Legend	
V/STOL	vertical and/or short takeoff and landing

Figure 2-20. Firing Procedures, Step 18.

Step 17: Super-elevate weapon.

Step 18: Obtain one of the sight pictures shown in figure 2-20 on page 2-22.

Step 19: Fire! Hold breath and continue tracking for 3 to 5 seconds (see fig. 2-21).

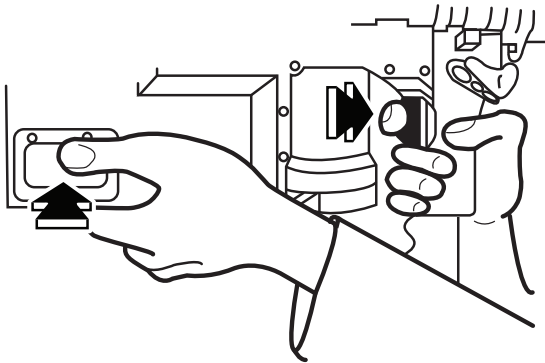

Figure 2-21. Firing Procedures, Step 19.

Step 20: Remove BCU within 3 minutes, keeping the top of the BCU pointed away from bare skin as high pressure gas may still be escaping (see fig. 2-22).

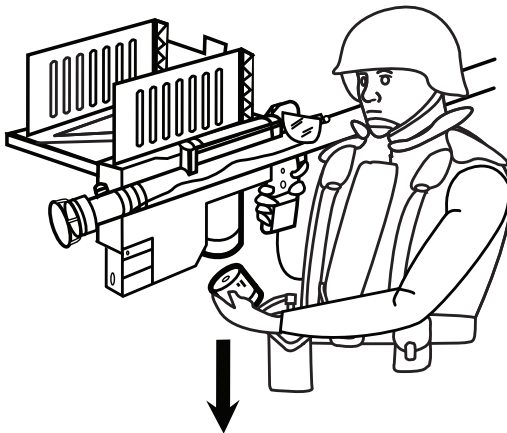

Figure 2-22. Firing Procedures, Step 20.

Post Firing Procedures

Remove the expended BCU from the gripstock within 3 minutes to prevent damage to the BCU receptacle. Remove the IFF cable by pulling straight down on the quick-release loop attached to the IFF cable connector. Close the IFF antenna. Place the expended weapon on the ground (or back in its container with its sight and IFF assemblies closed). When the situation permits, remove the gripstock assembly from the empty launch tube. The gripstock assembly can be reused on another missile round. Destroy the launch tube at a convenient time. When destroying the missile tube, remove all sight pieces. Destroy the tube by running it over with the vehicle.

Stinger Hang Fire, Misfire, and Dud Procedures

A hang fire is a delay in the functioning of a weapon round; it can last up to several minutes. A misfire is a complete failure to fire. A dud is a missile whose flight motor does not ignite (unzip), the missile ejects from the launch tube assembly, travels a short distance, and then falls to the ground.

Warning

For hang fire, misfire, or dud missile, evacuate the area around the missile for a distance of at least 366 meters (1200 ft). Guard the missile and keep it under observation. Do not approach it for at least 60 minutes; death or injury may result. The front portion of a misfire missile may remain hot. Proper precautions should be taken in handling the missile round. Whenever a Stinger team occupies a firing position, identify a suitable emergency destruction area at least 50 meters away.

Tactical situations determine how a hang fire or misfire will be handled. Dud locations will be marked, and then appropriate personnel will notify explosive ordnance disposal (EOD) personnel. Move at least 366 meters (1200 ft) from the dud site. Remember, the missile is classified SECRET and must be held under secure storage or under surveillance until EOD arranges its disposal. Local disposal is authorized as required.

If a missile does not fire—

- Continue tracking target for 3 to 5 seconds longer, keeping firing trigger and uncage bar depressed. If missile still has not ejected, release firing trigger and uncage bar and remove BCU.

- During annual service practice, place weapon round on ground or in dud pit. Point the weapon safely down range and away from personnel. Elevate the front end of the weapon approximately 20 degrees. Leave the firing site without passing in front of, over, or behind the weapon.
- Mark defective weapon's location.
- Notify EOD.

Destroying the Stinger Missile

A Stinger weapon system is destroyed when the team leader determines loss to the enemy is imminent. Destroying the weapon should guarantee that a usable unit cannot be reconstructed from several destroyed weapons. Damage all key components beyond repair. If key components cannot be destroyed, at a minimum, destroy the seeker head. Firing is the best method of destroying the missile. When the missile cannot be fired, destroy by burning, demolition, or small arms fire.

All missiles that are destroyed by firing or any other means must be documented. Destruction documentation includes the missile serial number, lot number, date-time group (DTG), and means of destruction. Forward this information up the chain of command as soon as possible. It is good practice for the section leaders to track missiles by serial number and team in case of compromise.

Burning

The Stinger contains both a live rocket motor and a high explosive warhead that create an extreme hazard when burned. Use extreme caution. If time permits, dig a hole about 1 meter (2 ft) deep and long enough to hold the Stinger. Smash the seeker, the

sight assembly, and the gripstock and place them in the hole. Place incendiary grenades around the Stinger or douse with flammable liquids. Cautiously ignite.

Demolition

Most gunners are not trained in explosive handling and detonating techniques; therefore, the following method requires EOD, engineer, or ammunition technician support.

- Use 7 1/2 lbs of C-4 explosive or equivalent per weapon.
- Place the charges lengthwise on top of the Stinger. Determine whether electrical blasting caps and wire or nonelectric caps and a safety fuse are available for priming and detonating the charges. If nonelectric blasting caps are used, crimp them to at least 2 meters (about 6.5 ft) of the safety fuse.
- Connect the charges with the detonating cord for simultaneous detonations if destroying more than one Stinger at a time. Dual-prime the charges to minimize chances of a hang fire or a misfire. If the charges are primed with nonelectric blasting caps, initiate the safety fuses and then immediately take cover. If primed with the electric blasting caps, take cover before firing.

Small Arms Fire

Use the following technique, only if no other method is available:

- Smash the seeker of each of the Stinger missiles.
- Stack or pile the Stinger weapons and all related equipment.
- Fire on the equipment from at least 50 meters (164 ft) with rifles, machine guns, grenade rounds, or rockets.

Note: Some of the ancillary equipment is marked with red arrows indicating where to fire upon for maximum damage.

Safety Distances

During annual service practice firing, personnel should not be closer than 50 meters (164 ft) to a firing point. Although these safety distances for personnel and equipment may not always be feasible under combat conditions. To minimize injury from flying glass and debris, personnel, equipment, and vehicles should not be closer than 5 meters (16 ft). The team leader should be close to the gunner's side to ensure that he/she is not endangered by the back blast. Damage to radio equipment may result if it is within the back blast area. Always inform the supported unit of the noise and back blast safety hazards (see fig. 2-23 on page 2-28).

Warning

Permanent deafness will result if personnel are exposed to more than two firings without hearing protection. Wear proper hearing protection! Personnel within 125 meters (about 400 ft) should also wear ear protection.

Fire only from the standing position. Wear ear protection, helmet, and body armor vest when firing.

The team leader should wear eye protection and the gunner must use the plastic eye shield on the weapon sight. Do not fire at an angle greater than 65 degrees as the debris caused by the missile back blast presents a hazard to the gunner if this angle is exceeded or if the launch tube is within 30 inches of the ground.

Note: Do not discard a used BCU into dry brush, grass, or near flammable materials.

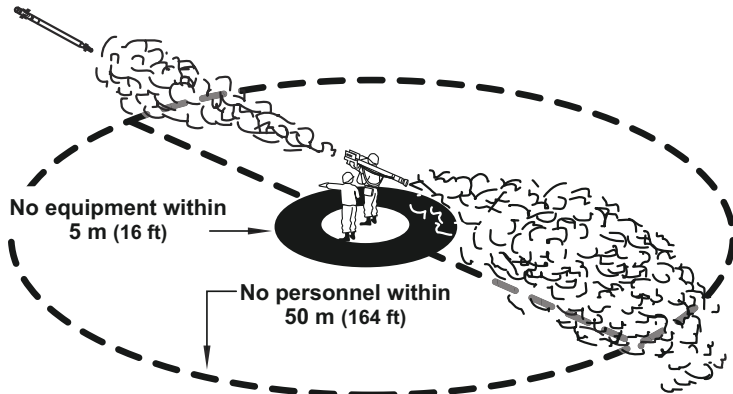

Figure 2-23. Safety Distance.

Nature of Infrared Radiation

Infrared radiation is the band of wavelengths in the electromagnetic frequency spectrum just below visible light. All substances radiate IR energy; the amount of energy depends largely on the air temperature. Infrared radiation energy has properties similar to light traveling in a straight line at the speed of light. The missile senses IR emitted by a target by focusing its energy on the surface of an IR detector in the seeker. The argon gas from the BCU cools the detector cell, increasing its sensitivity. When the seeker acquires the IR energy emitted by a target, acquisition signals produced by the weapon inform the gunner that the target has been detected. Although sunlight normally will not cause damage to the seeker, an uncovered seeker should be pointed away from the sun.

Atmospheric Conditions

The atmosphere is not completely transparent to IR. Certain gases in the atmosphere, primarily carbon dioxide and water vapor, absorb energy into the IR frequency spectrum. Because the amount of carbon dioxide in the air is fairly constant, its effect on detection range is consistent. Water vapor content varies widely with geographic location and local weather conditions. The sun's IR is also reflected from objects, causing them to become secondary sources of background radiation (false targets). Typical secondary sources are bodies of water, bare hillsides, and white clouds. Some sources of secondary background radiation are shown (see fig. 2-24).

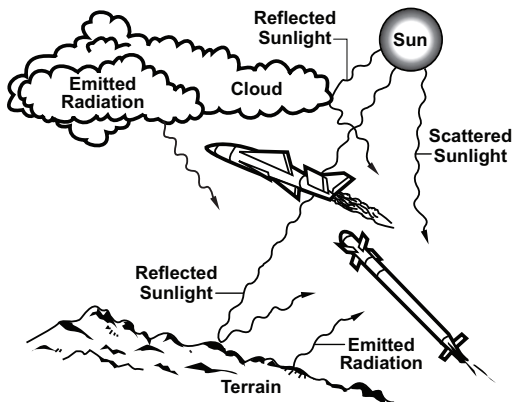

Figure 2-24. Sources of Background Radiation.

The Stinger seeker can discriminate between radiation from a small point source such as the tailpipe of a jet and large background sources such as clouds and terrain. Except for the sun, the target's engine exhaust is usually the smallest and hottest object in the environment and will be tracked by the missile seeker.

ADVANCED MAN-PORTABLE AIR DEFENSE SYSTEM

The A-MANPADS is a rapidly deployable weapon system consisting of a four-door high mobility multipurpose wheeled vehicle (HMMWV), which integrates a ring-mounted weapons station, storage rack for three or four Stinger missiles, single-channel ground and airborne radio system (SINCGARS) communications suite, ruggedized laptop computer for airspace situational awareness, global positioning navigation device, M2 or M240B machine guns, thermal optics for the missile, and crew-served weapons.

MEDIUM MACHINE GUN, 7.62mm, M240B (CREW-SERVED WEAPON)

The medium machine gun, 7.62mm, M240B is an air-cooled, belt-fed, gas-operated automatic weapon. It is able to provide a heavy, controlled volume of accurate, long-range fire that is beyond the capabilities of individual small arms. The weapon fires from the open-bolt position and is fed by a disintegrating belt of metal links. The gas from firing one round provides the energy for firing the next round. Thus, the gun functions automatically as long as it is supplied with ammunition and the trigger is held to the rear. It can be fired utilizing either the attached bipod mount, by mounting the weapon on the tripod, or mounting the weapon on the A-MANPADS vehicle using the M35 (H24-6) mount. The mounted configuration provides the most stable base for the weapon, enabling the gunner to maximize its range capabilities and deliver a high degree of accurate fire on target. The traversing and elevating (T&E) mechanism permits controlled

manipulation in both direction and elevation and makes it possible to engage predetermined targets during darkness or periods of reduced visibility. See TM, 08670A/09712A-10/1B, *Operator's Manual for Machine Gun, 7.62MM, M240 (1005-01-025-8095); M240B (1005-01-412-3129); M240C (1005-01-085-4758); M240D (1005-01-418-6995); M240E1 (1005-01-252-4288); M240H (1005-01-518-2410); M240L (1005-01-549-5837); M240N (1005-01-493-1666)*, for technical characteristics for the M240B machine gun. See chapter 3 of MCWP 3-15.1, *Machine Guns and Machine Gun Gunnery*, for complete information on the M240B.

Mounting the Weapon

The weapon will be mounted onto the A-MANPADS vehicle utilizing the components (see fig. 2-25). Adjustments and settings for use of the weapon with the A-MANPADS will be performed

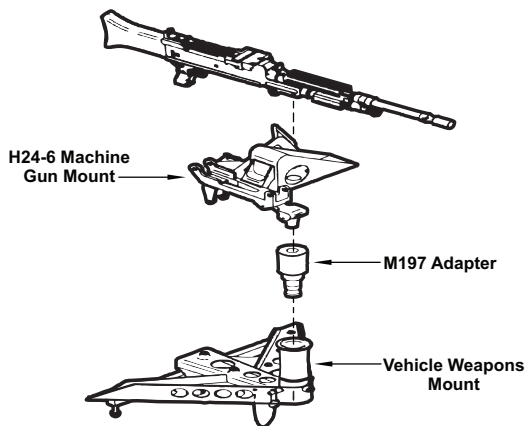

Figure 2-25. M240B Installation on Advanced Man-Portable Air Defense System.

in accordance with TM 11133A-OR/A, *Operator's and Organizational Maintenance Manual Guided Missile Battery Control Center Vehicle Mounted AN/TWQ-2 NSN 1430-01-531-2722*. The weapon may also be dismounted from the vehicle and employed with the M122A1 tripod (see MCWP 3-15.1).

Changing the Barrel

The ability to change the barrels of the M240B quickly provides a great advantage. It allows one barrel to be used while the other is cooling. This increases the life of each barrel and ensures a continuous rapid rate of accurate fire. Barrels should be changed when they are beginning to overheat. Changing a barrel only takes a few seconds and significantly improves the rate of fire and accuracy. As a guide, a barrel change is required after firing the sustained rate for 10 minutes and after firing the rapid rate for 2 minutes.

The procedures outlined below are for a vehicle-mounted gun. The process for changing a tripod or bipod-mounted gun can be found in MCWP 3-15.1.

- Ensure that the weapon is unloaded by first, removing the ammunition from the feed tray and then pulling the charging handle to the rear.
- Place the weapon on safe and have the A-gunner verify that the weapon is in condition 4.
- Once verified, rotate the turret of the vehicle until the barrel of the weapon is over the hood of the vehicle.

Note: Ensure personnel remain in compliance with range safety regulations while performing this step.

MCRP 3-25.10A

- Gunner depresses the barrel locking latch with his/her left hand, holding the barrel locking latch in a depressed position.
- A-gunner grasps the barrel by the changing handle, rotates it to its upright position, and pushes forward and pulls up, separating the barrel from the receiver.
- A-gunner grasps the spare barrel by the changing handle and, with the gunner again depressing the barrel locking latch, inserts the barrel socket into the receiver, aligns the gas plug with the gas cylinder, and pulls to the rear until the barrel is fully seated.
- Gunner then releases the barrel release latch.
- Once the barrel is fully seated, the A-gunner lowers the barrel-changing handle, counting the clicks (minimum two, maximum seven) to ensure proper headspace.

Once the barrel has been changed, rotate the turret so the weapon is pointing down range, load the weapon (condition 1), and continue to fire. The hot barrel will be placed on the hood of the vehicle away from flammable materials until cooled.

CAUTION: Personnel should exercise caution when climbing onto the vehicle. Attention should be made to avoid trip hazards (i.e. expended shell casings) in the area.

Defining a Hot Barrel

A machine gun is classified as “hot” if any of the following specifications have been met or exceeded:

- More than 200 rounds fired within a 2-minute period.
- A long continuous burst or repeated firing of the weapon even though you do not reach 200 rounds.

- Less than 15 minutes have lapsed since a round was fired from a hot barrel.
- If the vehicle commander for any reason determines the weapon is hot.

Stoppages and Malfunctions

Machine gunners must have a detailed understanding of the many component parts of their weapon, what those parts do during functioning, and what mechanical problems may be encountered during firing. This knowledge ensures that those problems will be quickly assessed and corrective action will be taken.

Stoppage

A stoppage is any interruption in the cycle of functioning caused by faulty action of the gun or defective ammunition; in short, the gun stops firing. Stoppages must be cleared quickly and firing resumed as soon as possible.

Malfunction

A malfunction is a failure of the gun to function satisfactorily; the gun will fire, but fires improperly. Defective ammunition or improper operation of the gun by a crewmember is not considered a malfunction. Two of the more common malfunctions are sluggish operation and runaway gun.

Sluggish operation is identified when instead of firing at its normal rate (approximately 9 to 10 rounds per second), a sluggish gun fires very slowly. It can be due to excessive friction or loss of gas. Excessive friction is usually due to lack of lubrication or excessive dirt/carbon in the gas system or on the bolt and receiver rails. Excessive loss of gas is usually due to loose connections in

the gas system. To reduce sluggish operation, move the regulator setting to the number 2 or 3 position (see TM 08670A/09712A-10/1B). To remedy continued sluggish operation, clean, lubricate, tighten, or replace parts as required.

Runaway gun is identified when a gun continues to fire after the trigger is released; firing is uncontrolled. A runaway gun is usually caused by a worn, broken, or burred sear. The sear shoulder is unable to grab the operating rod and hold it to the rear. An excessively worn sear notch on the operating rod could also be responsible. The action taken to stop a runaway gun, for both tripod and bipod-mounted guns, is for the team leader to twist and break the belt of ammunition. The remedy for a runaway gun is to replace worn parts.

Immediate Action

Immediate action is action taken by the gunner/crew to reduce a stoppage, without investigating its cause, and quickly return the gun to action. Hang fire and cook off are two terms that describe the ammunition condition and should be understood in conjunction with immediate action procedures.

A *hang fire* occurs when the cartridge primer detonates after being struck by the firing pin but some problem with the propellant powder causes it to burn too slowly and delays the firing of the projectile. Time (5 seconds) is allotted for this malfunction before investigating a stoppage further because injury to personnel and damage to equipment could occur if the round goes off with the cover of the weapon open.

A *cook off* occurs when the heat of the barrel is high enough to cause the propellant powder inside the round to ignite even though the primer is not struck. Immediate action is completed in

a total of 10 seconds to ensure that the round is extracted before the heat of the barrel affects it. When the round fails to extract/eject, further action is delayed (15 minutes) if the barrel is hot because the gunner must assume that a round is still in the chamber and could cook off before the barrel cools down.

Immediate action procedures for the M240B are as follows:

- Wait 5 seconds after the misfire to guard against a hang fire.
- Within the next 5 seconds (to guard against a cook off), pull the charging handle to the rear, observe the ejection port, and attempt to fire again (if brass is seen ejecting). If brass did not eject, place the weapon on S, determine if the barrel is hot (200 rounds or more fired in the last 2 minutes) or cold and perform remedial action.

Remedial Action

When immediate action fails to reduce the stoppage, remedial action must be taken. This involves investigating the cause of the stoppage and may involve some disassembly of the weapon and replacement of parts to correct the problem. Two common causes of a stoppage that may require remedial action are failure to extract due to a stuck or ruptured cartridge.

A *stuck cartridge* is when some swelling of the cartridge occurs when fired. If the swelling is excessive, the cartridge will be fixed tightly in the chamber. If the extractor spring has weakened and does not tightly grip the base of the cartridge, it may fail to extract the round when the bolt moves to the rear. Once the bolt is locked to the rear, the weapon is placed on S and the barrel has been allowed to cool. A length of cleaning rod should be inserted into the muzzle to push the round out through the chamber.

A *ruptured cartridge* occurs when a cartridge is in a weakened condition after firing. In addition, it may swell as described above. In this case, a properly functioning extractor may sometimes tear the base of the cartridge off as the bolt moves to the rear, leaving the rest of the cartridge wedged inside the chamber. The ruptured cartridge extractor must be used in this instance to remove it. The barrel must be removed and the extractor inserted into the chamber where it will grip and remove the remains of the cartridge.

Ammunition

This section describes the ammunition used with the M240B. Ammunition is issued as complete rounds consisting of the projectiles (bullets), cartridge cases, propellant powder, and primers. Ammunition is issued in a disintegrating metallic split-linked belt. The members of machine gun teams must be able to recognize the types of ammunition and know how to care for them. Ammunition for the M240B is classified as shown in figures 2-26 through 2-30 on pages 2-37 through 2-39.

Ball Cartridge

Usage: against targets of light material, personnel, and during marksmanship training.

Description: the M80 has a plain bullet tip.

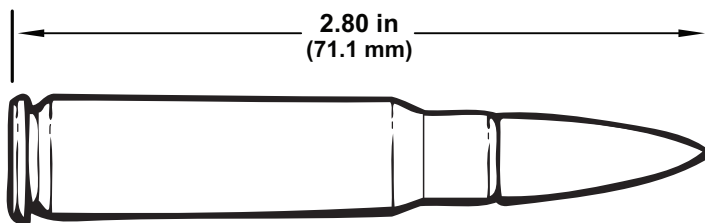

Figure 2-26. M80 Cartridge.

Tracer Cartridge

Usage: for observation of fire, incendiary effect, signaling, and marking targets.

Description: the tip of the M62 bullet is painted orange. The tip of the M62 overhead fire is painted red.

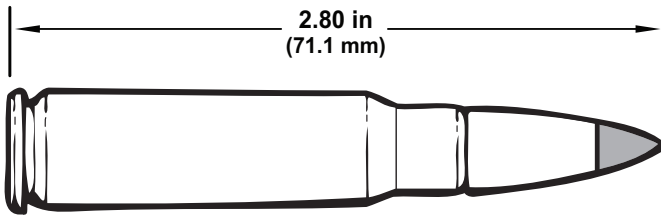

Figure 2-27. M62 Cartridge.

Blank Cartridge

Usage: during training when simulated fire is desired.

Description: the M82 cartridge has a double-tapered neck and no bullet.

Note: Requires installation of a blank firing adapter.

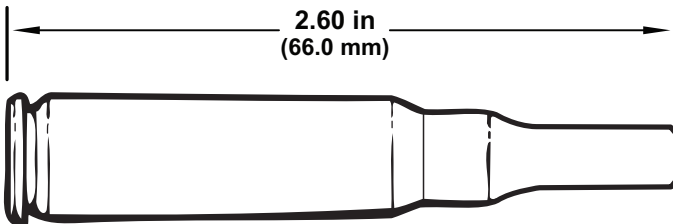

Figure 2-28. M82 Cartridge.

Dummy Cartridge

Usage: during training, such as gun a drill. It is completely inert, but simulates service ammunition for practice in loading the gun.

Description: the M63 cartridge has six longitudinal corrugations (flutings) on the cartridge. Also, there is no primer or vent hole in the primer pocket.

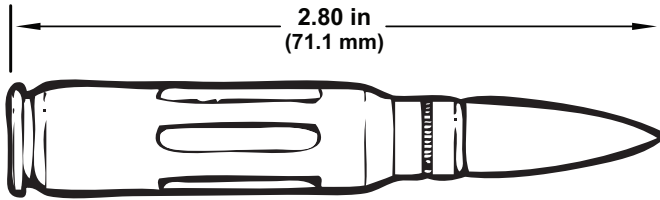

Figure 2-29. M63 Cartridge.

Armor-Piercing Cartridge

Usage: against lightly armored targets where armor-piercing effects are desired. This ammunition is not authorized for training purposes.

Description: the tip of the M61 cartridge is painted black.

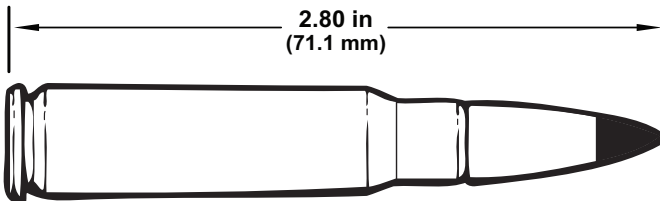

Figure 2-30. M61 Cartridge.

HEAVY MACHINE GUN, .50 cal, M2 (CREW-SERVED WEAPON)

The heavy machine gun, .50 cal, M2 is a belt-fed, recoil-operated, air-cooled, and crew-served machine gun. Supporting both the offense and defense, it provides the heavy volume of close, accurate, and continuous fire support necessary to suppress and destroy enemy fortifications, vehicles, and personnel in support of an attack. The long range, close defensive, and final protective fires delivered by this gun form an integral part of the unit's defensive fires.

The M2 is also used to—

- Provide protection for motor movements, vehicle parks, and train bivouacs.
- Defend against low-flying hostile aircraft.
- Destroy lightly armored vehicles.
- Provide reconnaissance by fire on suspected enemy positions.
- Provide final protective fires.

It can be fired utilizing either the M3 tripod or mounting the weapon on the A-MANPADS vehicle using the MK93 mount. The mounted configuration provides the most stable base for the weapon, enabling the gunner to maximize its range capabilities and deliver a high degree of accurate fire on target. The T&E mechanism permits controlled manipulation in both direction and elevation and makes it possible to engage predetermined targets during darkness or periods of reduced visibility. See MCWP 3-15.1 for more information on technical characteristics of the M2.

Mounting the Weapon

The weapon will be mounted onto the A-MANPADS vehicle utilizing the components in figure 2-31. Adjustments and settings for use of the weapon with the A-MANPADS will be performed in accordance with TM 11133A-OR/A. The weapon may also be dismantled from the vehicle and employed with the M3 tripod following the procedures found in MCWP 3-15.1.

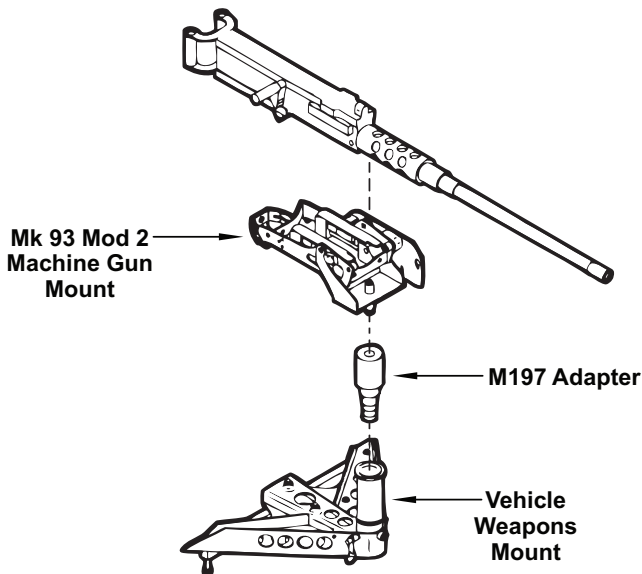

Figure 2-31. The M2 Installation on Advanced Man-Portable Air Defense System.

Head Space and Timing

The M2's headspace and timing must be set manually by the operator. A correctly set headspace and timing is essential for the safe and effective operation of the weapon. Procedures required

for proper adjustment of headspace and timing are located in MCWP 3-15.1.

Stoppages and Malfunctions

Machine gunners must have a detailed understanding of the many component parts of their weapon, what those parts do during functioning, and what mechanical problems may be encountered during firing. This knowledge ensures that those problems can be quickly assessed and corrective action taken.

Stoppage

A stoppage is any interruption in the cycle of operation caused by the faulty action of the gun or ammunition. Immediate action is required by the gunner to reduce a stoppage. The most common stoppages with M2 are failure to feed, failure to chamber, or failure to fire.

Malfunction

A malfunction is a failure of the gun to function satisfactorily; the gun will fire, but fires improperly. Defective ammunition or improper operation of the gun by a crewmember is not considered a malfunction. Two of the more common malfunctions are sluggish operation and runaway gun.

A *sluggish operation* is identified as instead of firing at its normal rate, a sluggish gun fires very slowly. Sluggish operation is usually due to human failure to eliminate excessive friction caused by dirt, lack of proper lubrication, and burred parts or by tight headspace adjustment or incorrect timing.

A *runaway gun* is when a gun continues to fire after the trigger is released; firing is uncontrolled. If the cause is present before the

MCRP 3-25.10A

gun is fired, the gun will start to fire when the recoiling groups move into battery the second time. If the defect occurs during firing, the gun will continue firing when the trigger control mechanism is released. A runaway gun may be caused by the following:

- Bent trigger lever, forward end of the trigger lever sprung downward.
- Burred beveled contacting surfaces of the trigger lever and sear.
- Jammed or broken side plate trigger.

To remedy uncontrolled automatic fire—

- Keep the gun laid on target and let the gun fire out all remaining ammunition.
- Twist the ammunition belt, only in an emergency because this causes the gun to jam and may damage the feeding mechanism.
- Replace broken, worn, or burred parts. Check the side plate trigger and trigger control mechanism, when applicable.

Immediate Action

Immediate action is defined as that action taken by the gunner and/or crew to reduce a stoppage, without investigating its cause, and quickly return the gun to action. Immediate action is performed by the gunner; however, every crewmember must be trained to apply immediate action. Hang fire and cook off are two terms used to describe ammunition conditions that should be understood in conjunction with immediate actions.

A *hang fire* occurs when the cartridge primer has detonated after being struck by the firing pin but there is some problem with the propellant powder that causes it to burn too slowly creating a delay in firing.

A *cook off* occurs when the barrel's intense heat—a result of prolonged or rapid firing—causes the unintended firing of a cartridge if it remains in the chamber exposed to that heat for too long.

Both a hang fire and cook off can cause injury to personnel or damage to the weapon. To avoid these, always keep the round locked in the chamber with the cover closed for the first 5 seconds after a misfire occurs. This prevents an explosion outside of the gun in the event of a hang fire.

If the barrel is hot, the round must be extracted within the next 5 seconds to prevent a cook off. When more than 150 rounds have been fired in a 2-minute period, the barrel is hot enough to produce a cook off.

If the barrel is too hot and the round cannot be extracted within the 10 second total, it must remain locked in the chamber, with the cover closed, for at least 5 minutes to allow cooling of the barrel. This guards against a cook off occurring with the cover open. If the cook off did occur with the cover open, injury to personnel and damage to the weapon could result.

The immediate action procedures for the M2 are as follows:

- If gun fails to fire, wait 5 seconds, a hang fire may be causing the misfire. In the next 5 seconds, pull the bolt to the rear (check for ejection and feeding of belt), release it, relay on the target and attempt to fire.

Note: When the bolt latch engages the bolt and holds it to the rear, the gunner must return the retracting slide handle to its forward position. If the bolt latch release and trigger are depressed at the same time, the bolt goes forward and the weapon should fire automatically.

MCRP 3-25.10A

- If the gun again fails to fire, wait 5 seconds, pull the bolt to the rear (engage with bolt latch if applicable), and return the retracting slide handle to its forward position.
- Determine if the barrel is hot or cold before continuing:
 - If the barrel is cold, open the cover, remove the belted ammunition, and inspect the weapon.
 - If the barrel is hot, repeat immediate action procedure for a hot barrel.

Remedial Action

Remedial action is taken when immediate action fails to reduce a stoppage; its cause must be investigated, usually by disassembling the weapon and inspecting the appropriate parts. Parts may have to be replaced before the gun can be returned to action. Removal of a cartridge from the T-slot and removal of a ruptured cartridge are two other problems that may be detected and corrected without the need for disassembly.

Removal of a cartridge from the T-slot takes place if the cartridge does not fall out, hold the bolt to the rear, and with the extractor raised, use a length of cleaning rod to push the cartridge out of the bottom of the receiver.

Removal of a ruptured cartridge takes place when a ruptured (separated) cartridge case is removed with a cleaning rod or ruptured cartridge extractor. To remove a ruptured cartridge with the ruptured cartridge extractor (.50 cal, 41-E-557-50, 7160041)—

- Raise the cover and pull the bolt to the rear.
- Place the ruptured cartridge extractor in the T-slot of the bolt in the same manner as that of a cartridge, so that it is held in line with the bore by the ejector of the extractor assembly of the gun.

- Align the ruptured cartridge extractor with the bore and hold firmly in the T-slot, let the bolt go forward into the battery. This action forces the extractor through the ruptured case and the shoulders will spring out in front of the case.
- Pull the bolt to the rear and remove the ruptured case and extractor.
- Always check headspace and timing after a ruptured cartridge occurs and set if necessary.

Ammunition

Ammunition is issued as complete rounds consisting of the projectiles (bullets), cartridge cases, propellant powder, and primers. Ammunition is issued in a disintegrating metallic split linked belt. The members of machine gun teams must be able to recognize the types of ammunition and know how to care for them. Ammunition for the M2 is classified as shown in figures 2-32 through 2-44 on page 2-47 through 2-53.

Ball Cartridge

Usage: in marksmanship training and against personnel and light material targets.

Description: the bullet tips of the M2 and M33 are plain.

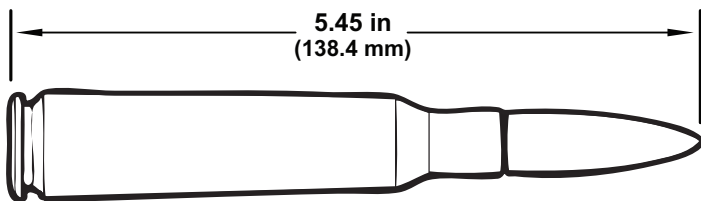

Figure 2-32. M2 or M33 Cartridge.

Tracer Cartridge

Usage: to aid in observing fire. Secondary purposes are for incendiary effect and for signaling.

Description: the tip of the M1 bullet is painted red and the tip of the M17 bullet is painted brown.

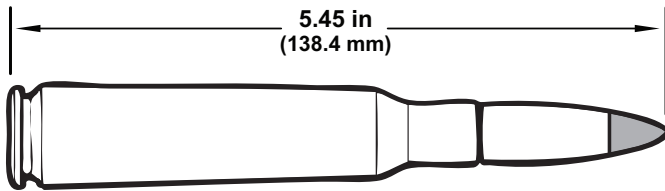

Figure 2-33. M1 Cartridge.

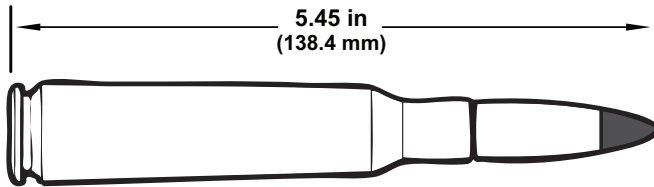

Figure 2-34. M17 Cartridge.

Blank Cartridge

Usage: during training when simulated fire is desired

Note: Requires installation of a blank firing adapter.

Description: the M1A1 has a double-tapered neck and no bullet.

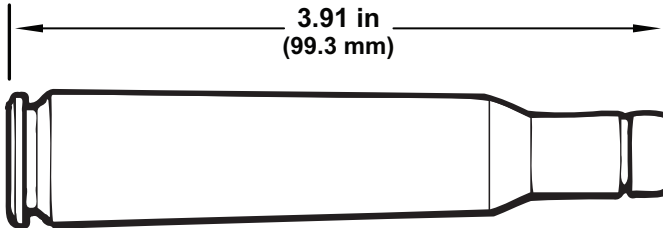

Figure 2-35. M1A1 Cartridge.

Dummy Cartridge

Usage: a dummy is completely inert. For use in nonfiring training such as gun drill and to practice loading and unloading procedures.

Description: the M2 has three drilled holes in the cartridge case and there is no primer.

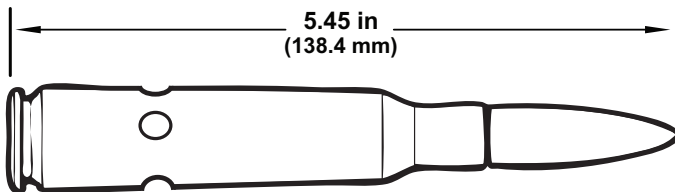

Figure 2-36. M2 Cartridge.

Armor-Piercing Cartridge

Usage: against armored aircraft and lightly armored vehicles, concrete shelters, and other bullet-resisting targets.

Description: the tip of the M2 bullet is painted black.

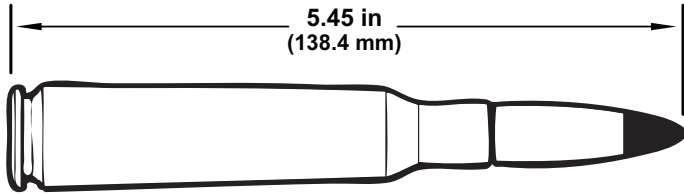

Figure 2-37. M2 Cartridge.

Incendiary Cartridge

Usage: for incendiary effect, especially against aircraft.

Description: the tip of the M1 bullet is painted blue

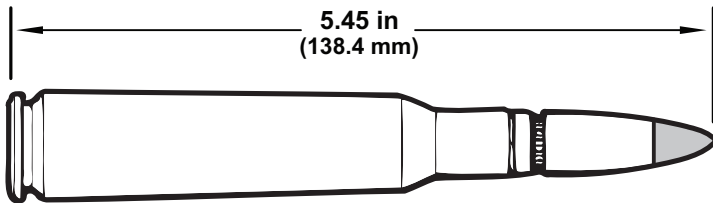

Figure 2-38. M1 Cartridge.

Armor-Piercing Incendiary Cartridge

Usage: for combined armor-piercing and incendiary effect.

Description: the tip of the M8 bullet is painted blue with an aluminum ring.

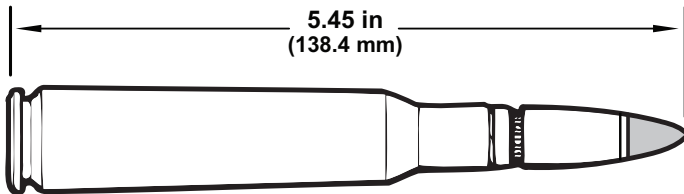

Figure 2-39. M8 Cartridge.

Armor-Piercing Incendiary Tracer Cartridge

Usage: for combined armor-piercing and incendiary effect with the additional tracer feature.

Description: the tip of the M20 bullet is painted red with an aluminum ring.

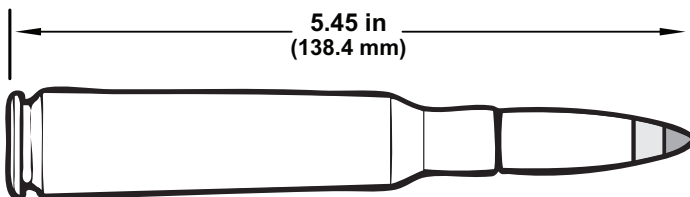

Figure 2-40. M20 Cartridge.

Sabot Light Armor Penetrator Cartridge

Usage: against light armored vehicles and aircraft. Also called SLAP.

Description: the M903 round is a tungsten penetrator in an amber-tinted sabot.

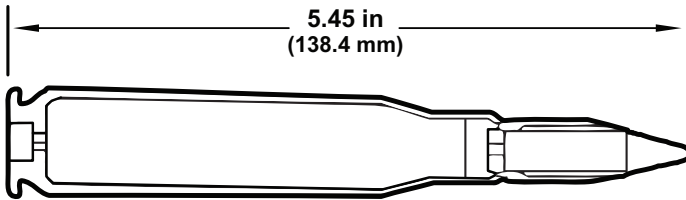

Figure 2-41. M903 Cartridge.

Sabot Light Armor Penetrator-Tracer Cartridge

Usage: against light armor vehicles and aircraft with the additional tracer feature. Also called SLAP-T.

Description: the M962 round is a tungsten penetrator in a red-tinted sabot.

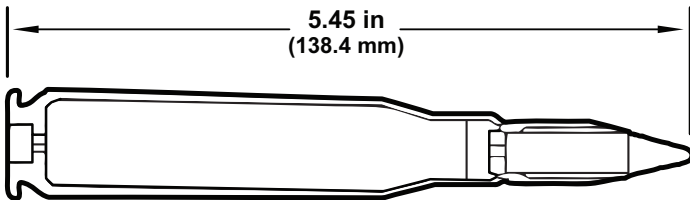

Figure 2-42. M962 Cartridge.

Ball, Plastic Practice Cartridge

Usage: in scaled range training. For example, where range restrictions limit or prohibit use of one of the other types of live ammunition.

Description: blue plastic bullet and case.

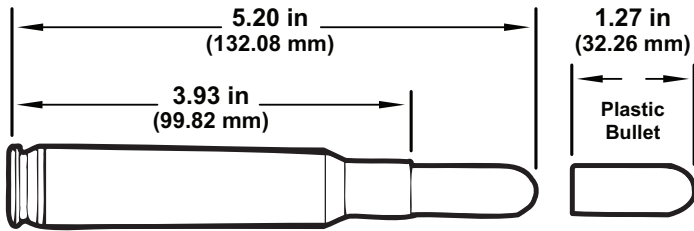

Figure 2-43. M858 Cartridge.

Tracer, Plastic Practice Cartridge

Usage: with the M858 in scaled range training.

Description: blue plastic bullet with red tip and case.

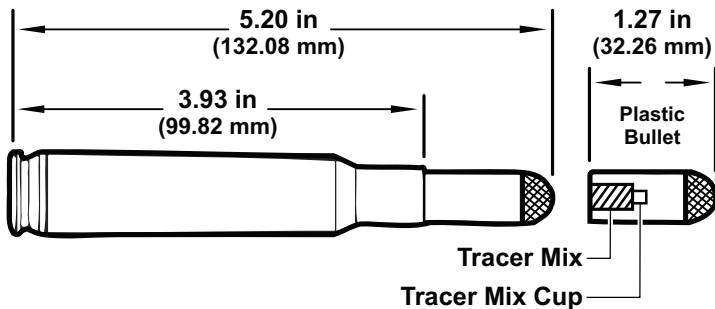

Figure 2-44. M860 Cartridge.

Chapter 3

Employment

Understanding the employment of LAAD assets first requires an understanding of the employment of air defense units as a whole. One of the first issues to address is the identification of the air defense priorities. A major challenge faced by MAGTF commanders is the proper employment of the limited number of surface-to-air weapon (SAW) resources to protect the MAGTF's critical forces and facilities. Two factors that impact this problem directly are the inability of existing MAGTF SAW to provide adequate air defense protection to every MAGTF asset and the lack of adequate air defense planning frequently provided to those defenses. Proper planning is a command responsibility that begins with the establishment of air defense priorities based on the MAGTF commander's intent and concept of operations. Air defense priorities must precede the employment of ground-based air defense units.

The LAAD section leaders and fire unit leaders should be capable of giving competent advice to supported units and their commanders on the subject of LAAD and its employment. To effectively employ the Stinger, the LAAD section team and gunners must consider the air threat, firing team integrity and location, alerting and cueing, and target destruction. These aspects must be considered based on the established ROE, air defense warning conditions, states of alert (SOAs), and weapons control status. Effective return to force (RTF) procedures must be established. Communications provide the means to tie the entire effort together. The LAAD team should be evaluated and employed based on mission, enemy, terrain and weather, troops, and support available-time available (METT-T).

AIR DEFENSE PRIORITIES

Air defense priorities are those selected MAGTF assets and areas that must be defended in priority order by supporting air defense systems. To determine these priorities, the MAGTF commander makes an evaluation of his/her force assets and areas and their need for air defense based on critically-vulnerability-threat (CVT). See Joint Publication (JP) 3-01, *Countering Air and Missile Threats*, for more information on air defense priorities.

According to JP 3-01, during the development of the critical asset list, “assets nominated for the critical asset list usually are prioritized based on a methodology of assessing the three major factors of criticality, vulnerability (includes recoverability), and the threat. This is called the ‘CVT methodology.’ The CVT process is objective and considers intelligence, air operations, ground combat operations, maritime operations and support operations. Each asset is evaluated against defined criteria, and these criteria are weighted based on the consideration of the [joint force commander’s] intent, concept of operations and [center of gravity] concerns.”

Criticality is the degree to which an asset is essential to accomplishing the mission. It is determined by assessing the impact that, damage to or destruction of the asset will have on the success of the operation/campaign. Damage to an asset may prevent, significantly delay or have no impact on the success of the plan.

Vulnerability consists of two parts, susceptibility and recoverability if attacked and damaged. Susceptibility is the degree to which an asset is susceptible to surveillance, attack, or damage. Recoverability, once a factor itself, is now a subset of vulnerability and is the degree and ability to recover or

reconstitute from damage in terms of time, equipment, manpower and ability to continue the mission. Commanders should consider the time to replace personnel, equipment, or entire units, as well as whether other forces can perform the same mission. Camouflage and concealment, mobility and dispersion, and the ability to adequately defend itself from air threats are factors that should be considered when assessing vulnerability, survivability, and cover (hardening).

Threat assesses the probability that an asset will be targeted for surveillance or attack by a credible/capable adversary. A thorough joint intelligence preparation of the operational environment, oriented specifically on adversary air and missile capabilities, is key to an accurate threat assessment. Examples include targeting information provided by intelligence estimates, past adversary surveillance and attack methods, and threat doctrine.

AIR THREATS FACING THE MARINE AIR-GROUND TASK FORCE

Fixed-Wing Attacks

The enemy will likely employ fixed-wing aircraft against our forces. Enemy pilots will try to fly outside of Stinger's engagement envelope or approach their targets at altitudes under 1000 ft and speeds of at least 450 kts. They will utilize IR countermeasures, flares, chaff, and electronic jamming. The enemy pilots will use approach routes that increase background IR sources and minimize the possibility of visual detection and recognition. They will approach the target from the direction of the sun or use the glare off water, ice, or snow. Enemy pilots will maximize use of low-level

penetration routes that offer good terrain masking. Due to high approach speeds, enemy pilots normally strike along the longest axis of their targets to give more time to inflict damage. If more than one pass is needed, different approach directions are used. Fixed-wing aircraft use three basic ordnance delivery techniques against ground targets. These techniques are level lay-down (see fig. 3-1), dive (from pop-up or from altitude) (see fig. 3-2 and 3-3), and loft (see fig. 3-4).

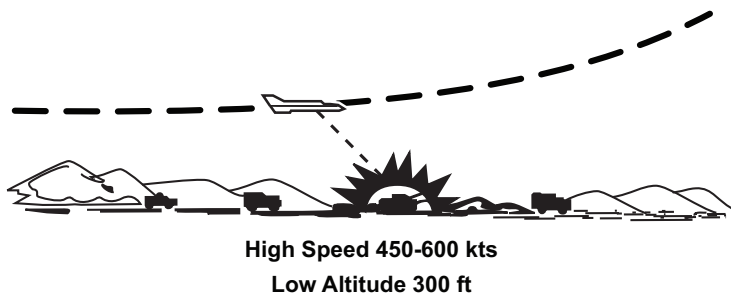

Figure 3-1. Level Laydown Technique.

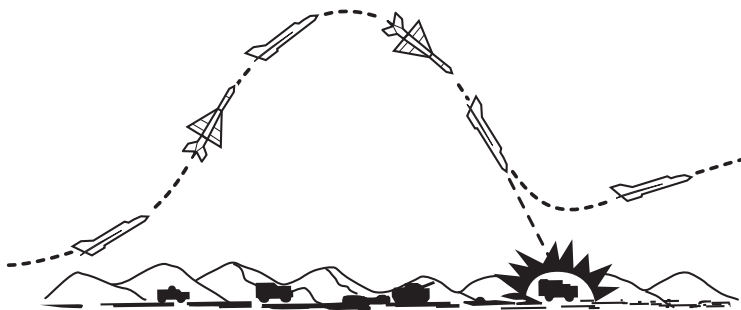
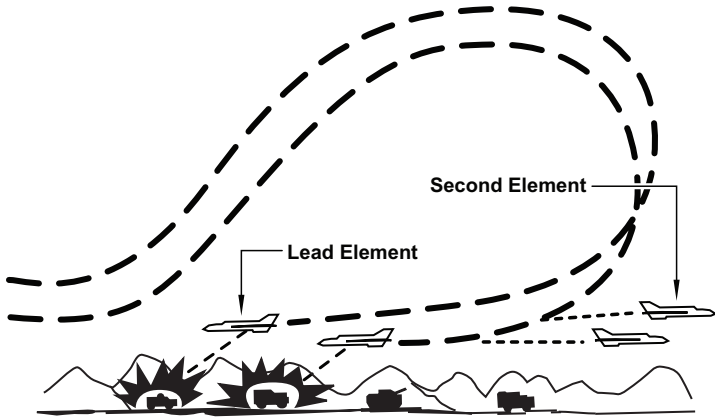
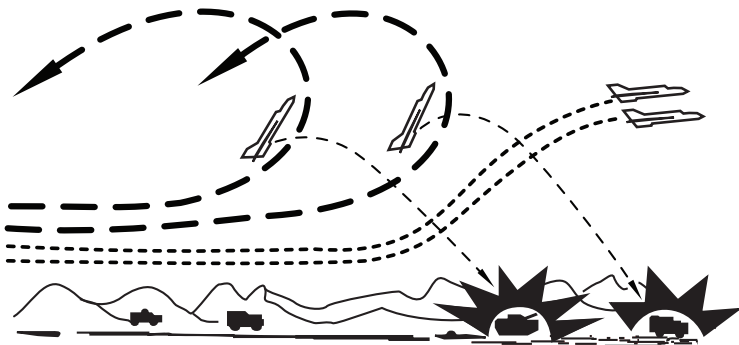

Figure 3-2. Dive Delivery (Pop-up Technique).



Lead element executing reversing maneuver

Figure 3-3. Dive Delivery (Altitude Technique).



Lead element executing reversing maneuver

Figure 3-4. Loft Delivery Technique.

Helicopter Attacks

Helicopters pose a major air threat to friendly forces in contact with the enemy. Although relatively slow, helicopters are very maneuverable and fly at low altitudes. They maximize cover and concealment by using buildings, vegetation, and terrain. Attack helicopters carry conventional ordnance; antitank guided missiles (ATGM); air-to-surface rockets; machine guns; and chemical, biological, radiological, and nuclear (CBRN) ordnance. Enemy attack helicopters will strike against preplanned, immediate targets and mechanized forces, conduct armed reconnaissance, provide fire support for ground attacks, and reinforce artillery fires and close air support. Using the nap-of-the-earth (NOE) and “sneak-and-peek” techniques, attack helicopters can be used against armor and mechanized units from standoff ranges of more than 5000 meters although pilots must expose their aircraft to aim and fire their weapons. For some ATGMs, pilots must also track both the missile and target or lase targets for fixed-wing aircraft throughout the missile’s or bomb’s time of flight (up to 30 seconds), long enough to conduct a Stinger engagement. See FM 44-18, *Air Defense Artillery Employment Stinger*, for more information.

AIR DEFENSE EMPLOYMENT PRINCIPLES

Ground-based air defense units utilize four air defense employment principles. The balanced application of these principles to each tactical situation will enhance the effectiveness of each Stinger unit and increase its survivability. The four principles that form the building blocks for the employment of air defense assets are mass, mix, mobility, and integration. See FM 3-01, *U.S. Army Air and Missile Defense Operations*, for more information.

Mass

Mass is the concentration of air defense combat power. The purpose of mass is to establish a favorable ratio of air defense units against threat attack aircraft. Ground-based air defense (GBAD) units employed in mass can place an effective, all-direction volume of fire on attacking aircraft. If GBAD units are not employed in mass, the threat aircraft could destroy not only the defended asset but also the defending GBAD units.

Mix

Mix is the balance between different GBAD units and/or GBAD units and air defense aircraft. A mix of air defense assets offset the limitations of one system with the capabilities of another. Employing the mix principle forces the enemy to use tactics against an array of systems rather than just against a single system. It is increasingly important for LAAD units to mix with joint GBAD units within the area of operation. This provides the maximum desired effect of available air defense assets. Mixing air defense weapons systems goes hand-in-hand with massing. If the threat planners fail to plan tactics and force structure against a massed and mixed defense, the price of enemy entry into the battle area will be high.

Mobility

Mobility is the dynamic nature of the battlefield that requires GBAD units to be highly mobile. Principles of mass and mix can be maximized through the effective use of mobility. Properly controlled movement ensures continuous coverage of the defended assets and reduces the enemy's capability to gain

precise targeting information on defending GBAD unit locations, thereby improving unit effectiveness and survivability.

Integration

Integration (vital to all operations in the air-land battle) occurs between air defense units as well as with the supported unit's ground scheme of maneuver. Integration requires effective command and control links capable of sustained operations in high-intensity CBRN and electronic warfare environments. An air defense system that does not maximize each component's capabilities and is not effectively integrated (including timely sharing of critical information) will be inefficient.

LOW ALTITUDE AIR DEFENSE EMPLOYMENT GUIDELINES

When LAAD unit commanders design a defense and select locations for their teams, certain general guidelines are considered. Understanding how and why GBAD units are employed aids the gunner in understanding the overall mission, and the commander's intent.

Balanced Fires

Position the LAAD units to permit approximately equal defensive fires in all directions (see fig. 3-5). Balanced fires take on added importance when facing a 360 degree threat.

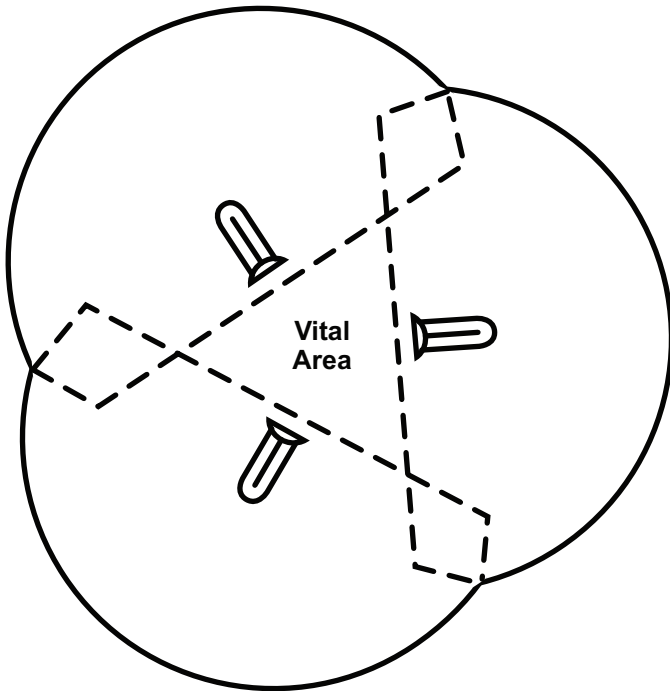

Figure 3-5. Balanced Fires.

Early Engagement

Teams should be positioned far enough out from the asset or unit being defended to permit the engagement of enemy aircraft before its ordnance release (see fig. 3-6 on page 3-10). The enemy's ordnance release line will vary with the type of aircraft and ordnance employed. For planning purposes, 1.5 km is the minimum ordnance release line figure to use for low altitude,

pop-up attacks. In some cases, ordnance may be released in excess of 20 km from the target. When developing air defense plans, consider threat tactics, flight profiles, and ordnance capabilities. Using unit internal assets to analyze threat capabilities will aid in determining employment.

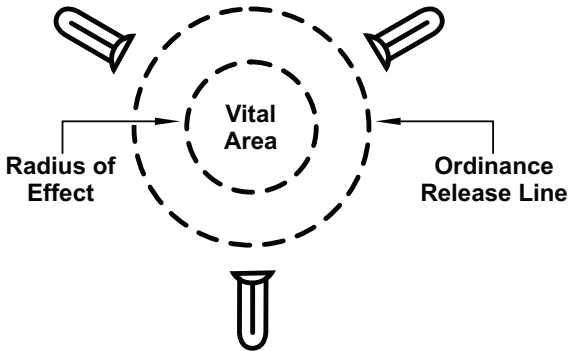

Figure 3-6. Early Engagement.

Weighted Coverage

Weighted coverage is achieved by concentrating teams toward known enemy locations, unprotected unit boundaries, or likely avenues of approach (see fig. 3-7).

Mutual Support

Mutual support results from positioning individual assets so they deliver fires into dead zones that surround adjacent assets. Mutual support enhances defensive survivability (see fig. 3-8). The required maximum distance between air defense units and assets to achieve mutual support varies depending on the type of air defense weapon threat characteristics.

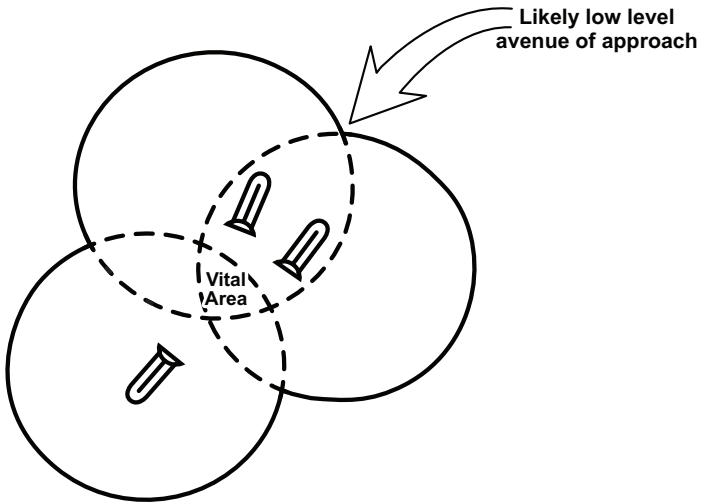

Figure 3-7. Weighted Coverage.

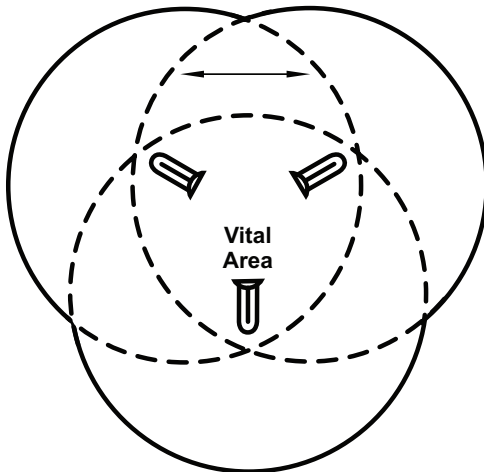

Figure 3-8. Mutual Support.

Defense in Depth

Defense in depth is achieved by positioning air defense assets so that enemy aircraft encounter an ever-increasing volume of fire as they approach a defended asset or area (see fig. 3-9). Integrating all air defense weapons used in the defense maximizes defense in depth.

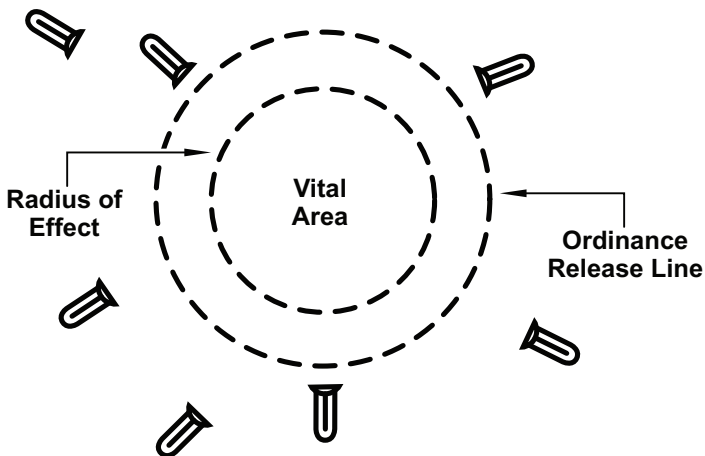
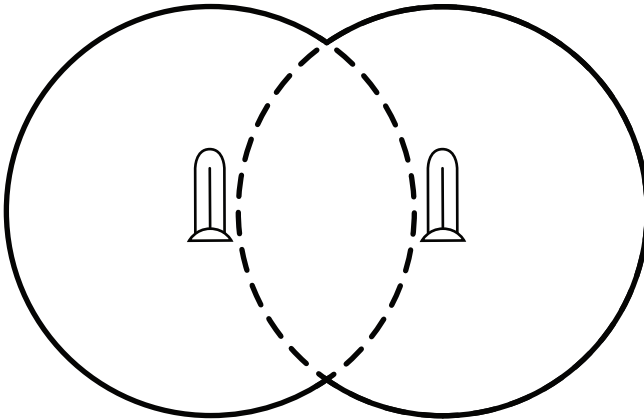

Figure 3-9. Defense in Depth.

Overlapping Fires

Overlapping fires occur when individual air defense units' engagement zones overlap (see fig. 3-10). Overlapping fires reduce the possibility of enemy aircraft slipping through an air defense without being engaged by at least one air defense unit.



**Figure 3-10. Low Altitude
Air Defense Overlapping Fires.**

CONSIDERATIONS FOR LOW ALTITUDE AIR DEFENSE TEAM POSITIONS

A LAAD firing team is comprised of two Marines: the team leader and assistant gunner. Team members will be trained as Stinger gunners, machine gunners, drivers, and on all associated support equipment. See appendix B for information on team mount-out for deployment. Mission accomplishment is the prime consideration in site selection. When a choice of sites is available, cover, concealment, and camouflage are considered in tandem with LAAD employment guidelines (see previous figs. 3-5 through 3-10). Particular attention is given to unobstructed fields

of fire, terrain, and back blast area. Terrain features that present a masking problem for Stinger employment are evaluated for height, distance, and direction from the firing positions. The firing positions should offer good communication with the section leader. If the team cannot communicate from its position, the position is unsatisfactory.

Note: It is important to have direct communication with the section leader. However, if direct communication is interrupted, relay messages through another team to maintain communication with the section leader. Team leaders must continue to establish communication with their section leaders.

Observation and Fields of Fire

Optimally, a team's firing position should be selected to provide members with all-around visibility and allow them to fire the Stinger in any direction. The firing position must allow coverage of the team's assigned sector to allow earliest detection of low flying aircraft, permitting engagement at the Stinger's maximum range. Firing positions should minimize masking effects of vegetation and terrain and maximize cover and concealment for team members and their equipment. The team may have to use separate, but linked positions for observation and firing. If time permits, routes into and out of these positions must be reconnoitered and selected. The routes should afford cover between positions. Weigh the advantages and disadvantages of each available position. The ultimate determining factor is how well the team can perform its mission from this location.

Accessibility

If time permits, routes into and out of firing positions must be reconnoitered and selected. The routes should afford cover between positions. The advantages and disadvantages of each available position must be weighed. The firing positions (both primary and alternate) should provide ready access to the vehicle (normally a HMMWV) to allow mobility, survivability, and rapid displacement.

Security from Ground Attack

The LAAD teams must take into consideration their location and what the ground threat's capabilities and limitations are when selecting a site to provide the team with the best protection from ground attack. The LAAD teams depend upon the supported unit for defense against ground attack. In doing so the LAAD team will consider the following:

- Moving too close to the supported unit can degrade the missile's effectiveness.
- The Stinger's launch signature can compromise the supported unit's location.
- When positioning outside the supported unit's location or near the supported unit's perimeter, teams must identify themselves to the supported units so they are not mistaken for the enemy or put in front of gun target lines.

Both section leaders and team leaders must ensure a balance between local security and mission capability. The LAAD gunner must ensure all safety parameters are met when selecting a site, with considerations of firing and the missile back blast.

LOW ALTITUDE AIR DEFENSE TEAM TACTICAL POSITIONS

Primary Position

Primary tactical firing positions are designated by section leaders and are listed in the five-paragraph order. Once the team leader reaches the designated position, he/she selects an exact firing position based on the ability to accomplish the mission from that location. If the team leader determines the site is not adequate to accomplish the mission, he/she will use one of the assigned alternate positions as the primary position or select another location as the primary position. A team position should consist of firing positions for both the team leader and assistant gunner and should be suitable to employ the vehicle-mounted machine gun. All team positions have a missile destruction pit (dud pit), fighting position, and a concealed position for the A-MANPADS vehicle that allows employment of the machine gun against both air and ground targets. The team leader selects alternate firing positions and will thoroughly brief the team on the exact team positions at the alternate site. The team leader will contact the section leader and provide the position of the alternate site.

Alternate Position

The Stinger's launch signature (back blast and exhaust trail) can be expected to reveal the team's position during an engagement. After an engagement in a forward area, the team must quickly move to an alternate position. In rear areas where the threat of enemy ground or artillery fire is remote, the need to move quickly to another position is not as great. When tactically feasible, alternate positions should not be more than 500 to 1000 meters from the primary position. The alternate position must cover the same sector of fire as the primary position.

Initial Tasks

The individual experience of each team will vary, however the general guideline is for the tasks to be completed immediately upon arrival at the primary position. It is the team leader's responsibility to ensure the tasks are assigned and completed in a timely manner. The initial tasks are to provide the minimum site preparation and are not the only tasks to be completed. These initial tasks are to provide position information to the section leader and to continuously monitor the radio, while at the same time, obtain the current air defense weapons conditions (ADWCs), SOA, WCS, and all other pertinent information. Preposition two ready rounds at the primary firing position with additional missiles accessible at the vehicle. Prepare two firing positions separated by 15 to 20 meters. During periods of observation, both positions are not required to be occupied. However, having two positions will ensure readiness and safety when confronted with multiple aircraft raids.

MCRP 3-25.10A

Using a compass, identify the team's sector of fire (after the assignment by the section leader) and primary target line (PTL), then apply sector stakes or terrain features to clearly delineate the sector boundaries. Construct a range card for the machine gun, keeping in mind the primary threat axis of a ground attack and air attack. Identify key terrain as sector limits. Begin surveillance, searching, and scanning for enemy aircraft and ground assault in accordance with current SOA. Move the vehicle with remaining missiles and supplies, emplace and camouflage the vehicle's position by taking advantage of natural foliage and terrain and cover any tracks leading to the position. The vehicle should be within a 50 meters radius of the firing position. Terrain generally dictates vehicle location. Defensive positions should be oriented against ground attack and separate from missile firing positions. The dud pit should be at least 50 meters from the firing position (see fig. 3-11). The location of this pit should allow for the placement and destruction of misfire rounds while not interfering with missile fires. The team leader will construct a range card for all firing points and weapons. Once all site preparations are complete, commence team operations in accordance with the current WCS, ADWC, and SOA. However, certain situations may dictate that operations commence prior to site preparations being completed. Camouflage, cover, and concealment are continuous.

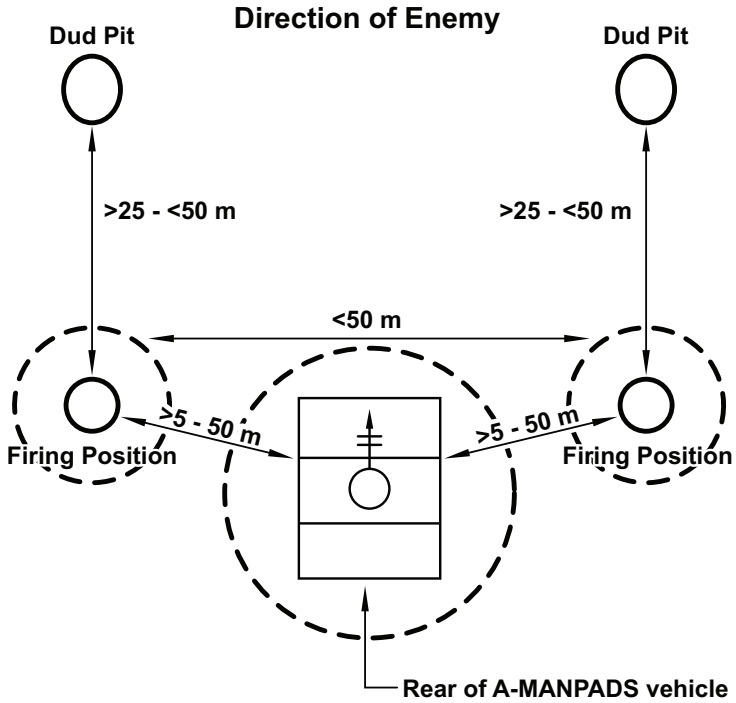

Figure 3-11. Advanced Man-Portable Air Defense System Stinger Firing Site Example.

ALERTING AND CUEING

Due to the Stinger system reaction time and the limited weapon firing envelope, LAAD units must receive the earliest possible notice (alerting) of potential air threats. Providing LAAD units with specific threat location information (cueing) allows them to engage enemy aircraft as soon as they become visible. The LAAD unit leaders will extract threat information from all available sources. Integrating into accessible ground-based data link-enhanced (GBDL-E) or collocating with other MACCS agencies, such as the Marine air control squadron or a Marine air traffic control detachment will enhance the alert and cueing capability. This approach will maximize broadcasting of threat information over all available LAAD nets and optimize weapons employment. The LAAD teams receive GBDL-E from radar-equipped units of the MACCS. The sensor air picture is shared among air defense units through a network of data links. For configuration and setup procedures see TM 10296A-10/1, *Field Handbook Expeditionary Air Defense System (EADS) Director Unit (DU)*. Marine air command and control system units that are GBDL-E capable are the TAOC with the tactical air operations module.

Information is extracted from available radar sources and transmitted to GBAD units by means of high frequency (HF), very high frequency (VHF), ultrahigh frequency (UHF), or multi-channel radio communications nets. All radar sources organic to the MACCS require the tactical interface box to tie in to the radar system. In addition to ground-based radar systems, limited US naval vessels of the amphibious assault ship (general purpose) and amphibious assault ship (multipurpose) class have been retrofitted with required equipment to convert tactical digital information link A data into GBDL-E for broadcast over VHF radio nets to GBAD units ashore during amphibious operations. For stations

receiving GBDL-E, the Baud rate is set at 2400 bps. To minimize direction finding tactics, LAAD elements transmitting GBDL-E should establish and maintain frequency hop nets to aid in countering direction finding threats. For LAAD assets to coordinate surveillance and early warning, manual cross tell of air tracks must be established with the MACCS agencies. The most common reference system used for manual cross tell procedures is the Cartesian coordinate grid reference system.

Cartesian Coordinate Grid

The Cartesian coordinate grid reference system is a manual cross tell system that uses four quadrants delineated by X and Y axes (see fig. 3-12 on page 3-22). The X and Y axes can either be oriented to true north, grid north, or magnetic north. The center of the grid, known as the Cartesian coordinate reference point (CCRP), is normally a geographic point that is recognizable to all participating agencies. The reference point can be a common geographic point, a mountaintop, or the location of the TAOC. Each rectangular quadrant of the grid system is assigned a name or is color coded so that the plot (target or track) can be reported rapidly to other units. For ease of depiction, the X and Y axes lines are normally marked in increments of 5 km, 5 nm, or 5 statute miles, but any common system of measurement could be used. Although the grid is commonly marked in increments of five, it is the responsibility of the individual reporting the track to extrapolate the target's location to the nearest single measurement. Track information is prepared for transmission by reading quadrants. The four quadrants are northwest, located in the upper left section of the X and Y axes; southwest, located in the bottom left section of the X and Y axes; northeast, located in the upper right section of the X and Y axes; and southeast, located in the bottom right section of the X and Y axes.

Note: For cueing purposes, the distance between hash marks should be estimated to the nearest single increment.

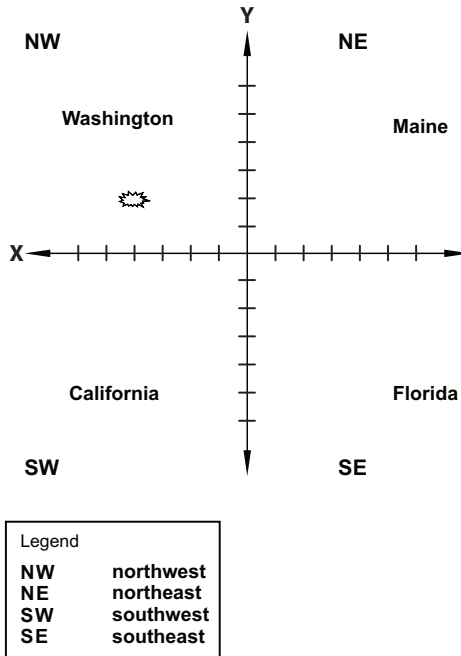

Figure 3-12. Example of Aircraft or Contact at Washington (20-10).

Warning

Red, yellow, and white should not be used as quadrant colors. Air defense warning conditions are identified by these colors and each has a specific meaning. Using these colors for both the ADWC and Cartesian quadrants may cause confusion.

Polar Coordinate Reference

The polar coordinate system is a circular coordinate system that uses a known location from a known reference point (KRP). Tracks are reported from the KRP at the center of the grid map using only radials (magnetic degrees) and miles. The reference point can be a geographical point or unit location such as the TAOC, as long as it is compatible to all participating agencies. The circular distances from the KRP can be in nautical miles, kilometers, or any other common system of measurement (see fig. 3-13). When using the polar coordinate system, the gunner must consider the information received in relation to the KRP. The cueing a gunner receives on an aircraft will usually be at a different azimuth and range than that of the team's actual position, unless the team is located at the known reference point.

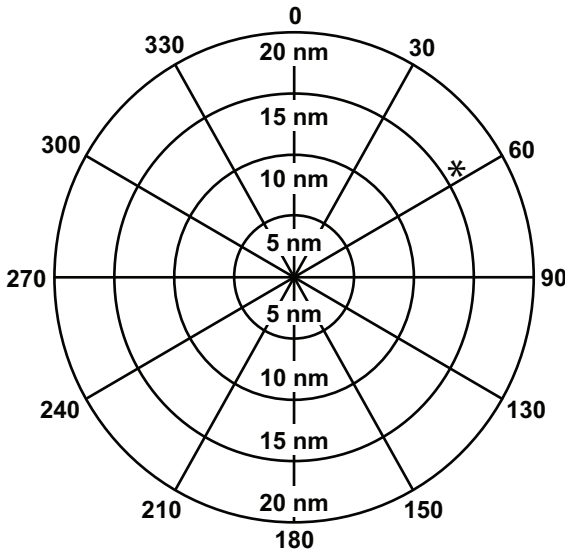
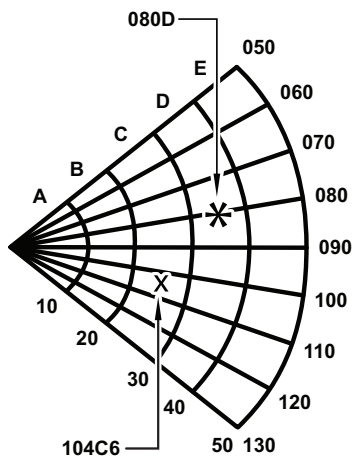

Figure 3-13. Polar Coordinate Reference.

Polar Grid

The polar grid system is a circular coordinate system that uses magnetic bearing in degrees and distances in nautical miles or kilometers from a specified reference point. The polar grid system uses an easily recognizable feature (a tactical air navigation marker or other location specified in the air tasking order's special instructions) as its center is aligned to magnetic north (see fig. 3-14).



An unknown aircraft detected in the vicinity of the * could be reported as “one BOGEY, 080D, heading west.”

Two hostile aircraft detected at the “X” (a precise reference point) would be reported as “two BANDITS, 104C6, heading west.” This report is derived from the exact magnetic radial (104 degrees) and the range (26 nm from the grid's origin), which places the hostile aircraft at 6 nm into the C band of the grid.

Figure 3-14. Polar Grid Reference System.

The polar grid system is comprised of a 10-degree radial, which originates from the grid's center and is further divided into 10 nm range bands. Each nautical mile range band is given an alphabetic designator, beginning with "A," from the origin. Broad brush references can be made using only the radial (to the nearest 10 degrees) and the range band (to the nearest 10 nm). More precise cross tell can be accomplished using the exact radial (to the nearest degree), the range band alphabetic, and the exact number of nautical miles within that range band.

VISUAL DETECTION OF THE TARGET

The first step in the destruction of an enemy aircraft by the Stinger is a visual detection of the target. A LAAD team may be warned of approaching aircraft over one of the LAAD nets. The LAAD team can narrow its search sector to the general direction of approaching aircraft after receiving the early warning. Terrain masking, aircraft characteristics, meteorological conditions, visual acuity, and search sector affect aircraft detection range.

Terrain Masking and Meteorological Conditions

Masking terrain will influence the distance at which low altitude aircraft will unmask (not hidden by a terrain feature). Rain, snow, dust, fog, smoke, heat shimmer, and haze reduce visibility and the visual detection range of aircraft.

Aircraft Recognition Characteristics

The larger the target, the farther away it can be detected. Apparent aircraft size varies with aircraft type and the aspect from which it is

MCRP 3-25.10A

viewed. A fighter flying a course directly toward an observer shows a small profile and the aircraft can get close to the observer before detection. The same aircraft on a crossing course has a much larger profile and can be detected at a greater range. An aircraft's paint scheme affects the degree in which the aircraft contrasts with its background. Some fixed- and rotary-wing aircraft have a smoke trail that aids in long range detection. Speed affects visual detection of aircraft. Detection range decreases as target speed increases. Aircraft flying at 150 to 1200 ft (46 to 366 meters) above the ground are detected at longer ranges than those flying over 1200 ft or below 150 ft. Many aircraft have unique signatures that can lead to early detection. The LAAD teams should look for the following:

- Sun reflection from aircraft canopies or cockpit windows.
- Blade flash from rotating helicopter blades.
- Smoke or vapor trails from jet aircraft and missiles or rockets fired from aircraft.
- Dust or excessive movement of treetops and bushes in a particular area.
- Noise from helicopter blades or from jets breaking the sound barrier.

VISUAL ACUITY

Observers must detect, recognize, and identify small objects at long ranges. They must have good eyesight and should rest their eyes periodically (about every 15 minutes) to prevent fatigue and maintain alertness. Visual detection is first performed by the team leader with the naked eye utilizing various search patterns.

Once detection of possible air threat is achieved, binoculars may be utilized to assist the team leader in the earliest possible identification of the aircraft. This method reduces the time required to search a given area of space. See FM 44-18-1 and FM 3-01.80, *Visual Aircraft Recognition*, for more information.

Search Sector

Search sectors should be as small as possible while having good coverage to both sides of the expected avenues of approach. The ability to detect aircraft increases as the size of the search sector assigned decreases. The team may be assigned a large sector for general surveillance if a cueing system is supporting the firing team. After receiving cueing, the search sector is narrowed and centered on the aircraft's approach azimuth. Decreasing the sector size to less than 30 degrees is not advisable because the alert warning system azimuth data may not be accurate. The search sector is defined in both horizontal and vertical planes (see fig. 3-15). Horizontal scanning and vertical scanning are the two systematic search methods.

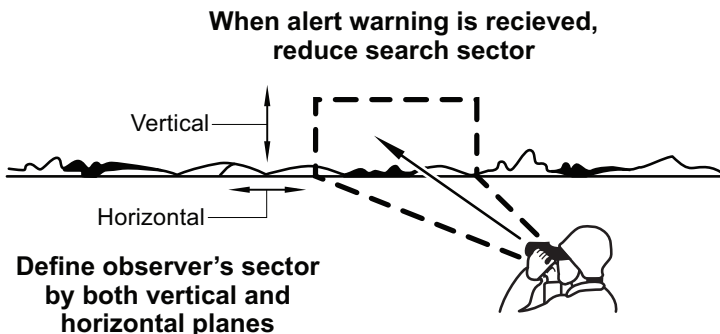

Figure 3-15. Sector Search.

Horizontal Scanning

The observer searches the horizon to about 20 degrees above the horizon by moving his/her eyes in short movements across the sky, working up and across. The observer continues the scan pattern to below the horizon to detect aircraft flying NOE (see fig. 3-16).

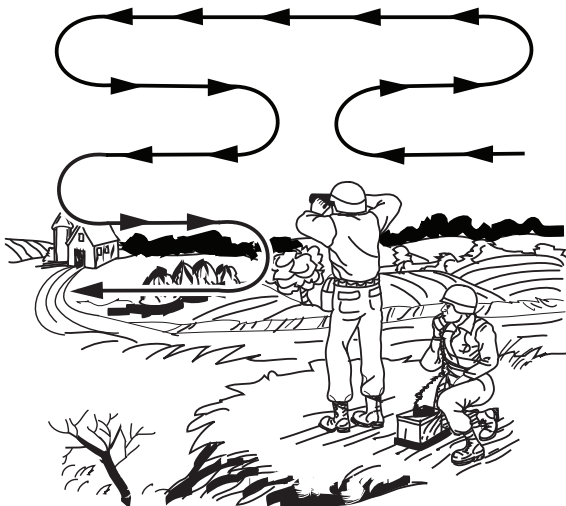

Figure 3-16. Horizontal Scanning

Using the hand is a simple way to estimate how high above the horizon to search. Facing the PTL, the left or right arm and the fingers are fully extended. The tips of the thumb and little finger should form a line perpendicular to the ground. When the little finger is touching the horizon, the tip of the thumb is approximately 20 degrees above the horizon (see fig. 3-17).

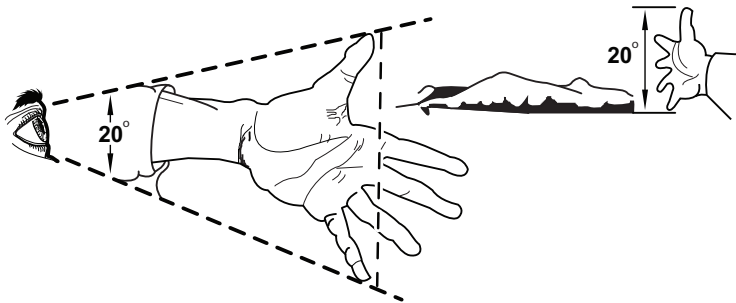

Figure 3-17. Estimating 20 Degrees.

Vertical Scanning

The observer searches the sky using the horizon as a starting point and prominent terrain features as a reference point. The observer moves his/her eyes in short movements up the sky, then back down, continuing this movement across the terrain. The observer scans in the same pattern below the horizon to detect aircraft flying NOE (see fig. 3-18).

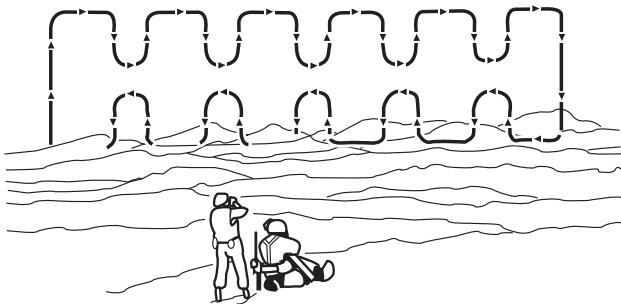

Figure 3-18. Vertical Scanning.

Nonsystematic Search Methods

Observers with more experience and above average visual efficiency may use nonsystematic search methods, such as a combination of the two systematic methods, search of the horizon in an oval shape to about 20 degrees above the horizon and general and/or random search of the horizon.

Scanning Tips

Observers should frequently focus their eyes on a distant object such as a cloud or terrain feature to avoid eye relaxation and blurring of distant objects. The observer should utilize binoculars if his/her eyes have trouble focusing at long ranges. The area near the sun is searched by extending the arm and hand as if to block out the sun's glare. Looking into the sun without shielding the eyes will cause blindness for a few seconds. The observer should keep his/her eyes on the aircraft upon seeing it. If the observer has to look away, he/she should note the direction of the aircraft and move his/her eyes away when the aircraft is near an object, such as a cloud or a terrain feature, which will guide the observer's eyes back to it. Team members should take turns searching for targets.

Where to Search

A map reconnaissance of the supported unit's direction of movement or area of operation helps to pinpoint areas from which aircraft are most likely to attack. Far sides of wood lines, ridgelines, and significant folds in the terrain are marked out to at least 3000 to 5000 meters (within range of attack helicopters' ATGMs). Mark restricting terrain where the supported units may be forced to bunch together, becoming lucrative targets for air attack. When accompanying maneuver units in contact with or

moving to contact with the enemy, the team usually concentrates its search for aircraft in the general direction of the enemy ground forces and occasionally searches the entire horizon. The team leader marks the route of advance and monitors the radio for warnings of approaching aircraft.

Aircraft Interrogation Techniques

The weapon system is aimed at the target and centered on the aircraft in the range ring. As soon as the target is in the range ring the challenge switch is pressed. The IFF operation is completely automatic.

Aircraft Identification

Normally, the team leader is responsible for target identification. Identification must be completed before the team leader issues a command to engage. When operating as a split team or if the team leader becomes a casualty, the gunner must assume identification responsibilities. After an aircraft has been detected, it must be identified as friendly, hostile, or unknown. Time for identification is limited. Identifying a fast-moving jet aircraft must be completed within approximately 5 to 15 seconds

ENGAGEMENT PROCESS

Decision

When the team leader or gunner identifies a target as hostile or (under certain conditions) as unknown and all other engagement requirements are met, the team leader makes the engagement decision. The team leader makes the decision based on the current

MCRP 3-25.10A

ROE and criteria passed by the section leader. The team leader is also responsible for selecting the method of engagement and the specific target to be engaged. If the gunner is alone, he/she engages the most threatening target first. The situations illustrated in figures 3-19 through 3-22 (on pages 3-32 through 3-35) show how a team leader uses ROE to reach an engagement decision.

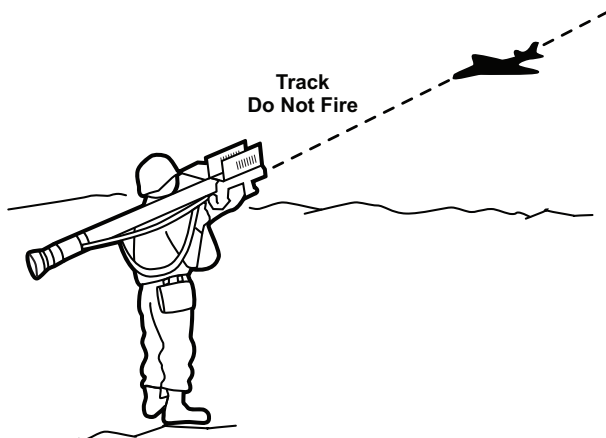

An aircraft approaches the team's position very fast and very low. The section leader announces a WCS of weapons tight. The gunner acquires the aircraft but cannot visually identify it and decides to interrogate; the gunner challenges and receives an unknown IFF response.

Action: The gunner cannot engage the aircraft because it does not positively identify as hostile; continue tracking the aircraft.

Reason: Weapons tight requires a hostile identification before engaging. As the aircraft comes closer, it is positively identified as a MIG-23 with enemy national insignia.

Action: Engage.

Reason: Aircraft was positively identified as hostile.

Figure 3-19. Situation 1.

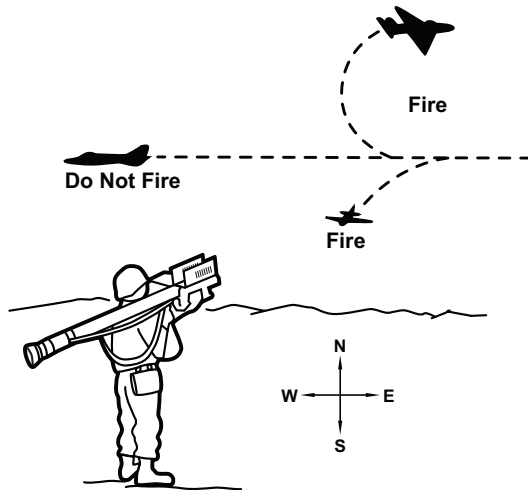

At 1230, the team leader receives a message from the section leader, "The current weapons condition is weapons hold on all jet aircraft flying westbound between 1300 and 1330, weapons tight for all other aircraft." At 1315, a jet aircraft recognized as hostile approaches westbound. It is coming within weapons range.

Action: Do not engage but continue to observe. Track the aircraft and wait to engage. Report the incident to the section leader. If the aircraft changes its heading so that it is no longer westbound, then engage.

Reason: Under weapons hold, the gunner cannot engage except in self-defense. If the aircraft changes its heading, WCS changes to weapons tight. Since the aircraft is already positively identified as hostile; engage. The aircraft continues on the same heading and fires two tactical air-to-surface missiles at the unit being supported.

Action: Engage.

Reason: The gunner has the right to engage any aircraft in self-defense. This rule applies not only to an attack on the position, but to the supported unit supporting as well.

Figure 3-20. Situation 2.

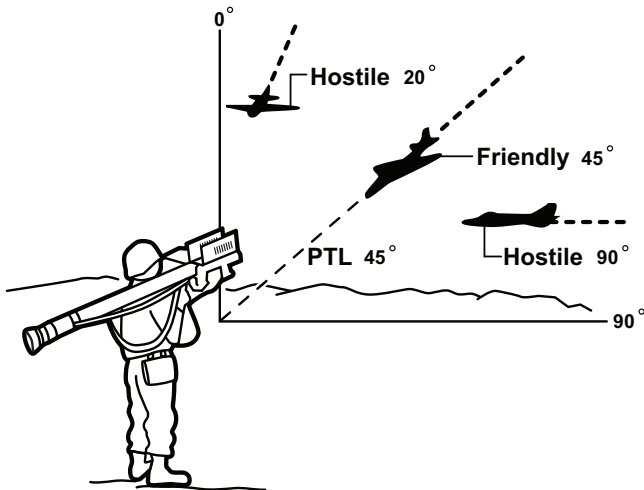

At 1400 the section leader orders a change to a new position to become part of a four team defense of a supply depot. Upon arrival, the primary search sector is 0 to 90 degrees and a primary target line at 45 degrees. The WCS is weapons tight. Three aircraft approach: one at 90 degrees, one at 45 degrees, and one at 20 degrees. All three are at the same range and appear to be moving at the same speed. The aircraft at 45 degrees is visually identified as friendly. The aircraft at 20 degrees is visually identified as hostile. The aircraft at 90 degrees is then visually identified as hostile.

Action: The gunner engages the aircraft at 90 degrees and the assistant gunner engages the second hostile aircraft at 20 degrees.

Reason: Since all three aircraft are at the same range and speed, they present an equal threat to the defended asset. The aircraft at 45 degrees is on the PTL and is the first aircraft to engage. Since it is positively identified as friendly and there are other aircraft in the area, ignore it and look at the second aircraft within the primary search sector and closest to the PTL. The second and third aircraft are identified as hostile. Since this is a multiple aircraft raid, the gunner engages the aircraft on the right and the assistant gunner engages the aircraft on the left at 20 degrees.

Figure 3-21. Situation 3.

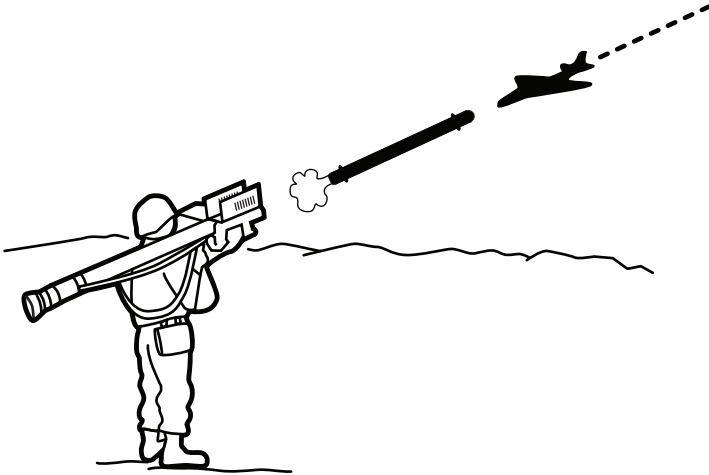

The section leader sends a message changing the WCS to weapons free. A jet aircraft approaches the position at low altitude and high speed. The aircraft is challenged upon on detection and the audible signal is unknown.

Action: Continue attempts to visually identify the aircraft while going through the engagement sequence and then engage.

Reason: The gunner is authorized to engage because weapons free means that all aircraft not positively identified as friendly should be engaged. This and coupled with the fact that an unknown audible signal to the IFF challenge was received and all attempts to positively identify the aircraft as friendly failed provides sufficient grounds to launch under weapons free. If there had been other aircraft in the area, the engagement sequence on the first aircraft would have continued while the assistant gunner directed his/her attention at the other aircraft and engaged if it was necessary. If the assistant gunner had identified the aircraft as friendly prior to launch, he/she would have called out "hold fire."

Figure 3-22. Situation 4.

Techniques of Fire

Proper firing techniques are necessary to successfully engage aircraft. These techniques are applied relative to the aircraft's direction, threat, and range. Use the missile firing procedures as detailed in chapter 2 to properly engage aircraft.

Aircraft Direction

Once the aircraft is detected, the weapon is sighted so the aircraft's image is aligned in the range ring of the weapon sight. Tracking the aircraft in the proper stance helps the gunner determine whether the aircraft is incoming, outgoing, or crossing. The gunner assumes a proper stance by stepping directly toward the target with his/her left foot and leaning toward the target. If the gunner has any horizontal movement of the arms or upper body as the gunner tracks the target, the target is considered crossing. If there is a lack of any substantial horizontal movement, the target should be considered incoming and/or outgoing. Also indicative of an incoming and/or outgoing aircraft is any vertical movement of the gunner's arms or upper body. Determination of crossover; i.e., the closest point the aircraft gets to the gunner, is important for applying aspect changes or activation decisions. Target size (getting larger or smaller) can assist the gunner in determining crossover or incoming and/or outgoing status.

Aircraft Threat

Upon detection, the team leader must immediately decide if the aircraft is a potential threat. If the aircraft's direction of flight indicates that it will penetrate the defended area, the gunner issues an IFF challenge. If the aircraft fails to respond correctly to the IFF challenge, it is considered a potential threat. The gunner then activates the weapon.

Aircraft Range

The gunner must evaluate the target and determine if the target is within missile range. The type of aircraft (jet or propeller) and the flight path (incoming, crossing, or outgoing) determines what rule to follow while making the launch decision. By applying the correct rule for the type and flight path of the aircraft, the gunner can be assured that he/she fires within the effective range of the missile and holds fire on targets outside the launch boundaries.

Incoming and/or Outgoing Jet Aircraft

For incoming and/or outgoing jet aircraft, the launch and hold fire decision for teams are based upon range ring measurements. The gunner moves the weapon so that the aircraft's image is within the range ring of the sight. The gunner then evaluates the size of the aircraft image relative to the width of the range ring.

For example, if the aircraft's width within the range ring is approximately one-half the size of the range ring, then the aircraft is at one-half range ring. A helpful hint in estimating aircraft size within the range ring is to place the aircraft at the inner left (or right) edge of the range ring before making a size estimate .

The gap at the bottom of the range ring is also used to measure range ring size. This gap measures one-fifth the size of the range ring. When an aircraft fills this gap, it is at one-fifth range ring (see fig. 3-23 on page 3-38). To determine when to activate, hold fire, or launch the missile at an incoming or outgoing jet, the gunner tracks the jet and makes continuous size estimations. When the jet reaches a specified range ring size, it is considered to be within range of the missile. This is the earliest point at which the gunner may launch.

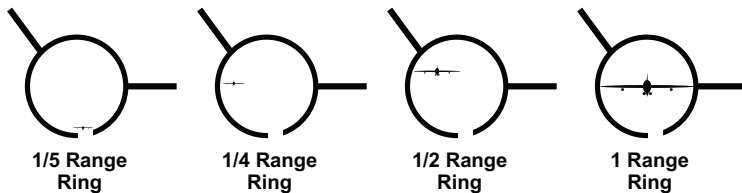

Figure 3-23. Incoming and/or Outgoing Jet Aircraft.

The gunner has a second range ring measurement to indicate when to hold fire, a third for resume fire, and a fourth for cease fire. The range ring measurements used in determining when to launch are classified and contained in FM 44-1A, *US Army Air Defense Artillery Operational Planning*.

Crossing Jet Aircraft

For crossing jets, the launch decision is based on a time count rule. Hold fire is based on a range ring measurement. The gunner positions the weapon sight slightly forward of a crossing jet's image and holds the weapon stationary. When the jet's nose reaches a fixed point within the sight, the gunner counts off in seconds, "one thousand one, one thousand two" and so forth while watching the jet travel horizontally to another fixed point within the sight. If the jet's nose reaches the second fixed point before or within the allotted time, then the jet is within range. The gunner can either activate or launch the missile, depending on the engagement stage. If the jet takes longer than the specified time to travel between points, it is beyond range and the gunner must not fire (see fig. 3-24). For actual fixed points and number of seconds (time count rule) or size used to determine when to activate, hold fire, or launch see FM 44-1A. For propeller aircraft (including helicopters), there is no time count or range ring measurements

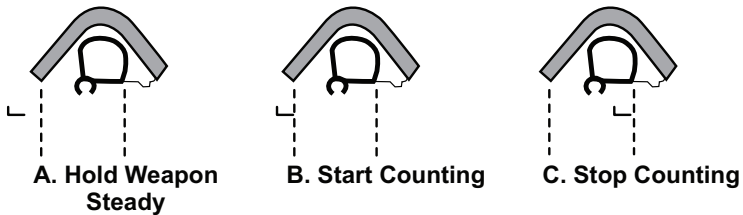

Figure 3-23. Crossing Jet Aircraft.

used. The gunner can launch the missile as soon as weapon activation occurs, after positive hostile identification (ID), and IR acquisition lock on.

Launch Rules

For jet aircraft only (both incoming and outgoing), a launch is made when the jet's image is the proper size within the range ring. The same rules apply for crossing aircraft. Launch if the jet meets the time count criteria. For all other aircraft (propeller), launch when a positive hostile ID and IR acquisition lock on are obtained. Hold fire on all targets when the inner launch boundary dictates.

Methods of Engagement

The number of enemy aircraft in a raid determines target engagement methods. Two or more aircraft flying the same course, at the same speed, less than 1000 meters apart can conduct multiple target raids. All other raids are single target raids.

Single Target Raids

All single target raids are engaged using a "shoot-look-shoot" method. The first missile is fired (shoot) as soon as engagement

requirements are met. Next, the missile's success is evaluated (look). If the first missile does not hit the target or does not achieve guided flight, a second missile is fired (shoot). After firing the first missile, the gunner immediately readies another weapon, regains visual track, and acquires the IR tone of the target. The gunner does not watch the missile's flight. The team leader observes the missile's flight, makes the kill evaluation, and, if time permits, directs the gunner to launch another missile. Under certain circumstances, the team leader may launch a missile.

Multiple Target Raids

Multiple target raids are engaged using a, "shoot-new-target-shoot" method. As many missiles as possible are launched at successive aircraft in the raid. When practical, fire coordination within a team will be on voice command of the team leader. When faced with multiple targets of equal threat, multiple team members will engage targets. The team leader should direct the gunners to fire at the lead hostile target in the sector of fire. The team leader engages the trailing hostile target.

Engagement Sequence

The engagement sequence outlines a basic sequence of events in the order that they usually occur for a team; however, it is not rigid. For example, determining aircraft type (jet or propeller driven) and identification may take place at any time before the launch. After the aircraft has been detected and identified, the appropriate technique of fire should be applied based on aircraft type. Certain actions, such as tracking and determining whether aircraft is incoming or crossing, are done throughout the engagement sequence. The engagement sequence usually falls in the following order: shoulder the weapon, interrogate the aircraft,

activate the weapon, continue tracking, determine range, super-elevation and lead, and fire.

Shoulder the Weapon

The gunner shoulders the weapon, unfolds the IFF antenna, removes the front cover, raises the sight, and connects the IFF cable. The gunner then moves the weapon so that the aircraft's image is placed within the range ring and begins tracking the target.

Interrogate the Aircraft

The gunner interrogates the aircraft. The team leader then considers an unknown reply, along with the aircraft's direction of flight, in determining whether the aircraft poses a threat to the defended area.

Activate the Weapon

The gunner activates the weapon when the aircraft appears to be penetrating the defended area and fails to correctly respond to an IFF challenge. The gunner will not activate if the gunner determines that he/she will be unable to engage the target successfully before it leaves the area.

Note: For the RMP Stinger, only a low hum can be heard from the weapon round after activation and gyro spin up.

Continue Tracking

If the signal is strong enough for seeker lock on, the seeker is uncaged. The tone should become louder and steadier. If the tone is lost, the uncage bar is released and retried. If the target cannot be locked on, sweeping the target or performing the figure eight method is recommended. The IR acquisition lock on is necessary

for all targets before firing. Ensure the acquisition tone is not from background or another IR source. When the target is acquired, a clear 1200 cycle tone is heard. If acquisition is lost, the tone is lost.

Note: For the RMP Stinger, a slow, steady tracking motion is used in lieu of the sweeper or the figure eight method.

Determine Range

The proper launch rule is applied for an incoming or crossing jet to determine if the aircraft is within the Stinger missile's range (disregard if propeller aircraft). Determining the right moment to launch the Stinger is one of the most critical decisions made by the gunner. The gunner must evaluate the target and determine if the target is within the Stinger's range. This decision requires knowledge of the type of target being engaged and the ability to range the target. To aid the gunner in making a launch decision, range cards should be made for both primary and alternate firing positions. Use a map for determining distance and plot the distance to various landmarks or terrain features. When team personnel are oriented with a map and know approximate distances to various landmarks, it is a simple matter to construct a range card. The range card enables the gunner to have a ready reference to various ranges within view of his/her position. By knowing the capabilities and limitations of the Stinger weapon and the ranges of various landmarks and objects, the gunner can readily determine if a target can be engaged. Other aids for estimating ground distance to distant objects are binoculars, the naked eye, and the gunner's hand. These aids supplement range data when maps are not available. The gunner may sight an object with binoculars or through the range ring on the Stinger's sight and find the range of specific landmarks or temporary objects located on the ground

within view of the position. See MCWP 3-11.2, *Marine Rifle Squad*, for more information on range estimation techniques.

Super-Elevation and Lead

As the uncage bar is pressed and held, the tone strengthens. Super-elevation and lead are applied by placing the aircraft image in the proper super-elevation and lead reticle. Place the sight of the weapon on the nose of the crossing jets in the appropriate lead reticle. Place the sight on incoming or outgoing jets in the center reticle. Place the sight on all helicopters and propeller aircraft in the center reticle. Do not offset during IRCCM. If the tone is lost any time after uncaging, release the uncaging bar, and re-acquire target and tone.

Note: For the RMP Stinger, after target acquisition, uncage and continue to track for 2 seconds before super elevating.

Fire

To initiate firing, squeeze the trigger while still holding the uncage bar. Hold your breath for 3 seconds.

Note: For the RMP Stinger, if the target acquisition is maintained (tone still present) after super elevating and leading the target, squeeze and hold the trigger for 3 to 5 seconds. See appendix C for engagement report format.

RULES OF ENGAGEMENT

Only appropriate US authority may declare a force as hostile. Competent authority will establish ROE for identifying and attacking hostile aircraft. The ROE tells LAAD units what, when,

and where they can shoot. At a minimum, the ROE will include the right of self-defense, target identification criteria, and weapons control status. Some ROE, such as WCS, change frequently and are ordered into effect in specific areas at specific times. If the tactical situation warrants, intermediate commanders may make these rules more restrictive within their sectors or ZOAs, but may not make them less restrictive than those imposed by the MAGTF commander. Weapons free zones may be established to give LAAD gunners the ability to maximize the potential of the Stinger system.

Right of Self-Defense

Any aircraft attacking friendly forces within the LAAD unit's area of responsibility may be engaged with any weapons available. The right of self-defense is never denied.

Target Identification Criteria

Target ID criteria are provided as examples to aid the commander in planning air defense and should not be considered all-inclusive. Target ID criteria may be altered or changed at the commander's discretion.

Friendly Aircraft

Aircraft are considered friendly under any one or a combination of the following situations:

- Visually identified as friendly.
- Declared friendly by an appropriate MACCS agency.
- Electronically identified as friendly via noncooperative target recognition.

- Transmitting an appropriate friendly Mode IV IFF response.
- In proper correlation with flight plan or coordinated mission brief or operations order and within the restrictions of safe passage corridor with appropriate IFF response. For example, transiting a weapon engagement zone at the correct altitude and airspeed on an active minimum risk route (MRR); squawking proper Mode IV, Mode III, or within corridor; and properly performing identification turn, landing gear down.

Hostile Aircraft ("BANDIT")

Some factors and circumstances (not all-inclusive) that may be used to develop ROE criteria to declare aircraft hostile include—

- Identified as enemy in accordance with theater ID criteria.
Note: The term hostile aircraft does not imply direction or authority to engage.
- Visually identified as hostile (based on military markings and/or aircraft configuration).
- Attacking friendly forces.
- Declared hostile by an appropriate MACCS agency.

An aircraft is also declared hostile if it performs any of the following acts over friendly troops or territory without prior coordination:

- Discharging smoke or spray.
- Discharging parachutists or unloading troops in excess of normal aircraft crew.
- Engaging in mine laying operations.

MCRP 3-25.10A

- Committing an offensive act. For example, conducting an act or maneuver that poses a threat to friendly forces.
- Employing electronic attack.
- Operating at prohibited speeds, altitudes, or in prohibited directions.
- Operating outside safe passage corridors or flying under minimum altitude specified in the ROE and is inbound to friendly forces.
- Entering into an area designated as restricted or prohibited without proper authorization.

Warning

Care should be exercised in applying this criterion to avoid engaging a friendly aircraft that is damaged and is returning to its base. It may have inadvertently strayed into a restricted area due to a navigational error. LAME DUCK aircraft can also discharge smoke or spray. Gunners must follow ROE to ensure those aircraft are not automatically declared hostile.

Unknown (“BOGEY”)

Many air tracks are initially unidentified and are labeled as unknowns. Resolution of unknown status must be made rapidly, so that LAAD capabilities are not handicapped. The ROE should specify procedures for handling unknown aircraft. For instance, ROE may allow surface-to-air intercepts of an unknown aircraft if it enters a missile engagement zone (MEZ) at high subsonic or supersonic speed or if it is not transmitting correct IFF codes. The right of self-defense always applies. Unknown aircraft are

prosecuted in accordance with current weapons conditions and ROE. Unknown aircraft have—

- A negative Mode IV response.
- Not been identified by appropriate higher authority as either friendly or hostile.
- Not been visually identified as friendly.

Weapon Control Status

The WCS defines restrictions on firing Stinger and other air defense weapons for a particular area and time period and consist of the following:

- Weapons free (teams engage all aircraft not positively identified as friendly).
- Weapons tight (teams engage any aircraft positively identified as hostile).
- Weapons hold (Do not open fire or cease fire on aircraft currently engaged. Do not fire except in self-defense or in response to a formal fire control order).

In the event of lost communications, LAAD units will follow the WCS procedures detailed in appendix D. Also see FM 3-01 for more information.

AIR DEFENSE WARNING CONDITIONS

Air defense warning conditions indicate probability of air attack. They are passed by the senior air control agency to all MAGTF

MCRP 3-25.10A

elements. Warning conditions may differ from one area of the battlespace to another due to the tactical situation and level of enemy air threat. The audio signal for warning condition is verbal or data communications passed over established nets. There are three levels of audio signal warnings. They are categorized as red, yellow, or white.

Red means attack by hostile aircraft and/or missiles is imminent or in progress (hostile aircraft are within an air defense sector or are in the immediate vicinity of an air defense sector). A codeword may be assigned to signify warning condition red per the unit SOP.

Yellow means attack by hostile aircraft and/or missiles is probable (hostile or unknown aircraft are en route or within an air defense sector). A codeword may be assigned to signify warning condition yellow per unit SOP.

White means attack by hostile aircraft and/or missiles is improbable. The audio signal for warning condition white is verbal or data communications passed over established nets. A codeword may be assigned to signify warning condition white per unit SOP (see FM 3-01).

AIR DEFENSE STATES OF ALERT

The SOAs for all organizations including those not dedicated to air defense are shown in table 3-1. States of alert define degrees of combat readiness more specific than, but in concert with, air defense warning conditions. The SOAs increase or decrease readiness, allowing units to rest, move, perform maintenance, resupply, etc., and more importantly, establish the period of time when the air defense unit must be able to engage a target.

Table 3-1. States of Alert.

Action	SOA A: Battle Stations	SOA B: 5-minute Alert	SOA C: 1-hour Alert	SOA D: 4-hour Alert
Surveillance	Assigned sector and all visible avenues of approach	Assigned sector	Assigned sector	As directed
Communi- cations	All nets	All nets	All nets	As directed
Movement	None	None	Mission essential within immediate vicinity of position	As required
Maintenance	None	None	Preventative	As required
Resupply	Delivered to team only in critical circumstances	Delivered to team only in critical circumstances	Mission essential routine distribution IAW section SOPs	Mission essential routine distribution IAW section SOPs
Weapons	2 missiles immediately ready to fire	2 missiles ready within 10 seconds	2 missiles readily available	Basic load on hand
Rest	None	None	1 Marine as required	As required
Legend				
IAW in accordance with				

MCRP 3-25.10A

The following are primary SOAs:

- **SOA A: Battle Stations.** Marines are in their assigned firing positions. All communications nets are monitored. At the team level, one member is scanning all visible avenues, while the other is searching the threat sector. Missiles are immediately ready to fire.
- **SOA B: 5-minute Alert.** Marines will be in the immediate vicinity of their firing positions. There will be no movement in or out of the team position. All communications nets are monitored. At the team level, both gunners are alert. One team member maintains surveillance over the assigned sector of fire. At least two missiles are ready and available for immediate use. Units can assume that an air attack is probable and may occur within the next 5 minutes.
- **SOA C: 1-hour Alert.** Marines will be in the general vicinity of their positions. Only mission essential movement and resupply takes place. All communications nets are monitored. One team member will maintain surveillance over the team's assigned sector of fire. At least two missiles will be readily available. Units can assume that an air attack is probable and may occur within the next hour.
- **SOA D: 4-hour Alert.** Marines use the time for movement, resupply, maintenance, improving positions, and rest. Communications nets are monitored as directed. Units can assume that an air attack is improbable within the next 4 hours.

FIRE CONTROL ORDERS

Fire control orders are commands used to control air defense engagements on a case-by-case basis. Fire control orders—such

as, engage, cease engagement, hold fire, resume fire, cease fire, and cover—may be issued regardless of the weapons control status in effect.

Engage is used to direct or authorize units and/or weapons systems to fire on a designated target in air defense. This order cancels any previous fire control order.

Cease engagement is used to direct units to stop the firing sequence against a designated target in air defense. Missiles already in flight will continue to intercept. This order may be used to reallocate fires against a higher priority target. It may also be used to preclude undesired simultaneous engagements of a target by more than one weapon system.

Hold fire is an emergency order to stop firing in air defense. If possible, missiles already in flight must be prevented from intercepting. This order may be used to protect friendly aircraft or in the interests of safety.

Resume fire is the command given to terminate a hold fire order.

Cease fire is a command given to air defense units to refrain from firing on, but continue to track, an airborne object. Missiles already in flight will be permitted to continue to intercept. This order is primarily used to prevent simultaneous target engagements by different units or with different types of air defense weapons.

Cover is used to order a fire unit to assume a posture that allows immediate engagement of a target if directed. To carry out this order, SAW units with tracking radars achieve a radar lock on a specific target. The cover command can be used for targets that

are presently being engaged by another fire unit or for targets that have not yet become a significant threat.

INGRESS, EGRESS, AND RETURN TO FORCE CONTROL PROCEDURES

Procedures must be established to allow friendly aircraft to safely move in, out, and through MAGTF airspace. The most difficult aspect of the air defense task is planning for friendly air operations to support the MAGTF while protecting it from air attack. Control procedures must be thoroughly examined, especially for safe passage of friendly aircraft through restricted areas. Use of control procedures should maximize the safety of the defended area while minimizing the possibility of fratricide. See MCWP 3-22 for a complete description of these procedures. Examples of ingress, egress, and RTF control procedures include the use of ingress or egress corridors and routes, low-level transit routes, MRRs, control points, visual identification, altitude and airspeed restrictions, strict LAME DUCK procedures, and well defined airspace coordination areas.

BASE DEFENSE ZONE PROCEDURES

The base defense zone (BDZ) is a destruction area established around an air facility site or forward operating base (FOB) to allow for the launch and recovery of friendly aircraft while maintaining an air defense posture. The BDZs are limited to the engagement envelope of the SHORAD weapons systems

defending that base. For MAGTFs, LAAD battalion assets are employed for BDZs. The BDZs have specific entry and exit points as well as IFF procedures associated with their use. The LAAD assets will integrate with the Marine air traffic control detachment (MATCD) operating at the airfield where the BDZ is established. Preplanned BDZs are published in the airspace control plan, while requests for activation of BDZs are made to the aviation combat element or MAGTF commander. Three critical elements are required to establish a BDZ: a controlling agency (Marine or joint/multinational air traffic control system, TAOC), radar, and weapon system. If any of the three critical elements is missing, the BDZ becomes a point defense where ADWC, SOAs, and WCS apply.

Marine Air Traffic Control Detachment Low Altitude Air Defense Integration

The MATCD has the requisite doctrine, forces, equipment, and capabilities to effectively manage and control a BDZ. The success of the BDZ is predicated on integration of the SHORAD and Marine air traffic control (MATC) personnel. The LAAD section leader, responsible for supervising Stinger fires within the BDZ, is located in the MATCD control and communications subsystem at a control scope with the approach controller. The approach controller monitors MATC's assigned airspace and provides cueing to the section leader. The section leader's control scope should depict the airspace, individual team positions, sectors of responsibility, and manual cross tell system. The approach controller provides the section leader with cueing on all air tracks within MATC airspace out to 60 nm (111 km) and 60,000 ft above ground level. The section leader provides cueing and aircraft position updates to the fire teams. The detailed entry,

exit, and IFF procedures, which are required for the launch and recovery of friendly aircraft within the BDZ, are monitored by the MATC tower, departure, approach, and radar controllers to ensure that friendly aircraft safely pass through the air defenses. The BDZ operations may be conducted 24 hours a day.

Command and Control

The process of C2 within the BDZ is accomplished through the LAAD team control net between the section leader and the Stinger teams. The WCS are applicable to the BDZ, which is a departure from traditional defenses. Aircraft are engaged based upon the classification of an aircraft by air traffic control, either through electronic means (i.e., IFF), the determination of non-compliance with pre-briefed approach procedures, lack of voice communication, or visual identification by LAAD teams. The constant dialogue between section leader and approach controller provides fire teams with a steady flow of accurate friendly and threat air activity information within the BDZ. Teams that lose communications with the section leader will immediately revert to weapons tight during daylight hours or weapons hold at night and assume a point defense role until communications with the section leader can be restored. Likewise, if air traffic control radar and data links to the TAOC are inoperable or not providing a recognized air picture, all LAAD assets within the BDZ will revert to a point defense. A point defense allows LAAD gunners to engage hostile aircraft in accordance with the established ROE and WCS.

Ingress or Egress Control Procedures

Procedures are established that allow friendly aircraft to transit safely in and out of the MAGTF's airspace. See MCWP 3-22 for

a complete description of these procedures. Examples of ingress or egress control procedures include the use of—

- Ingress or egress corridors for both rotary- and fixed-wing aircraft.
- Checkpoints.
- The tactical air navigation system.
- Altitude and air speed restrictions.
- LAME DUCK procedures.
- Airspace coordination areas.

CHEMICAL, BIOLOGICAL, RADIOLOGICAL, AND NUCLEAR OPERATIONS

The following are CBRN responsibilities for LAAD teams:

- Stinger teams must notify the section leader immediately upon being contaminated and then take appropriate action.
- Teams must continue the mission until given further direction.
- Stinger teams must be familiar with and able to pass the nuclear, biological, and chemical (NBC)-1 report (see app. B).

The following are CBRN responsibilities for individual Marines:

- When deployed, Marines will carry three nerve agent antidote kits (NAAK).
- They are responsible for decontamination of themselves using the M291 kit or reactive skin decontamination lotion (RSDL)

MCRP 3-25.10A

and hasty decontamination of their personal equipment using the ABC-M 11 decontamination apparatus.

- Marines should also be familiar with the characteristics of chemical agents (see table 3-2).

Table 3-2. Chemical Agent Characteristics.

Category	Symbol	Normal state when disseminated	Persistency	Effect	Time to incapacitation
Nerve agent	GB	Vapor or aerosol	A few minutes	Lethal on troops	Very short (death may occur in a few minutes if agent inhaled)
Nerve agent	VX	Liquid	A few hours to 4 days	Lethal on troops Contamination of terrain and equipment	A few hours (delayed casualties)
Blister agent	HD	Liquid	Usually a few days, possibly a few weeks	Incapacitation of troops Contamination of troops and equipment	A few hours (delayed casualties)
Bood agent	CX	Vapor or aerosol	A few minutes	Incapacitation of troops Contamination of terrain and equipment	Immediate
Choking agent	CK/AC	Vapor or aerosol	A few minutes	Incapacitation of troops Contamination of terrain and equipment	Immediate

Mission-Oriented Protective Posture

The levels of mission-oriented protective posture (MOPP) are MOPP-0, MOPP-1, MOPP-2, MOPP-3, and MOPP-4 (see table 3-3). The considerations for MOPP levels are—

- **MOPP-0.** Before intelligence indicates possible use.
- **MOPP-1.** Before first use of chemical agents.
- **MOPP-2.** During all combat operations against a threat force capable of employing biological and chemical agents, including weather conditions favoring threat CBRN use.
- **MOPP-3.** When nonpersistent agents are detected and identified.
- **MOPP-4.** When chemical agent attack is imminent or in progress.

Table 3-3. Mission-Oriented Protective Posture Levels.

MOPP Level	Over Garment	Over Boots	Mask/Hood	Gloves
0	Nearby	Nearby	Carried	Nearby
1	Worn	Carried	Carried	Carried
2	Worn*	Worn	Carried	Carried
3	Worn*	Worn	Worn*	Carried
4	Worn (closed)	Worn	Worn (closed)	Worn

* Worn open or closed depending on the temperature and/or threat activity.

Immediate Action

When MOPP-2 or higher is set, each Stinger team should be put on rotating MOPP-4 (one Marine in each team goes to MOPP-4). At the end of a 15 to 30 minute period, the other Marine goes to

MOPP-4, while the first one resumes the set MOPP level. If an aircraft is sighted that is spraying, the MOPP-4 Marine engages it while the other Marine goes to MOPP-4. After the aircraft is engaged and both Marines are in MOPP-4, they should sound the CBRN alarm and take cover until the agent stops falling. The Stinger team then sends an NBC-1 report to the section leader.

Subsequent Action

The Stinger team—

- Evaluates and treats casualties with NAAK, CANA [convulsant antidote for nerve agent], and M291 or RSDL.
- Conducts hasty decontamination with ABC-M 11.
- Conducts MOPP gear exchange as soon as tactically feasible (no later than 6 hours after attack).
- Moves to designated areas and conduct deliberate decontamination of personnel, vehicles, and equipment with adjacent or supported units as soon as tactically feasible.

Chemical, Biological, Radiological, and Nuclear Alarms

Vocal and/or audible alarms are given in all cases as soon as a Marine has donned and cleared their protective mask after an attack or hazard is detected. Due to distance between Stinger teams, the primary method of passing the CBRN alarm is by radio. Rapid and continuous beating on any metal object or any other object that produces a loud noise, a succession of very short blasts on a vehicle horn, or a succession of short blasts or warbling of a hand cranked siren may also be used.

Note: Stinger units located outside the battalion's immediate area must coordinate with the senior agency present/supported unit to ensure they are included in the CBRN alert and reporting system for that area of operation.

Unmasking

Stinger teams unmask when directed by section leaders or when supported unit unmask. If the alert area covers a large section of the MEZ, unmasking is directed by the section leader in a team by team sequence. This ensures that air defense coverage is maintained during the unmasking procedure.

Nuclear, Biological, and Chemical-1 Report

Messages containing a NBC-1 report include precedence, date-time group (local or ZULU), and security classification. Include type of report (NBC-1 Nuclear, NBC-1 Chemical, or NBC-1 Biological). The LAAD teams will follow the NBC-1 format (see app. C).

Chapter 4

Training

Marine leaders have the responsibility to establish and conduct technical and tactical training to enable Marines to successfully accomplish the unit's mission. The complexities of amphibious, joint, and multinational operations highlight the importance of individual and unit training for LAAD Marines. See FM 3-01.11, *Air Defense Artillery Reference Handbook*, for more information.

Mastering individual skills is the beginning of an effective LAAD team and critical for mission accomplishment. Aircraft identification, weapon handling, decisionmaking, and evaluation of the gunner's skills are key factors in individual gunner training. Tasks are broken into two groups: common tasks that must be mastered by all individuals and tasks required by duty positions.

INDIVIDUAL TRAINING

Training requirements for employment of the Stinger weapon system are standardized in Navy/Marine Corps Departmental Publication 3500.57, *Low Altitude Air Defense (LAAD) Training and Readiness Manual*. The training and readiness (T&R) manual specifies training events and position requirements necessary for Marines to attain specific position designations. Follow-on formal training is available to Marines who demonstrate military occupational specialty (MOS) proficiency.

FORMAL SCHOOLS

Entry-level training for antiair warfare officers and Stinger gunners is conducted at the US Army Air Defense School, Fort Bliss, TX. The officer course focuses on training in aircraft identification, Stinger missile operating characteristics, employment, and the application of air defense principles. Opportunities are provided to track simulated targets in the moving target simulator, conduct terrain analysis, and observe live tracking and missile firing. The course for enlisted Marines emphasizes the engagement process, aircraft and vehicle identification, and employment of the Stinger missile system through lectures and tracking exercises in the moving target simulator. The course culminates with a live missile fire exercise.

On-the-Job Training

Specific academic and practical application training standards for antiair warfare officers and Stinger gunners are in the T&R manual. Officers and enlisted personnel have different training standards. Marines serving as a platoon sergeant or section leader have separate training standards. Tracking of individual readiness is computed by the aviation training and readiness information management system. See MCWP 3-25.3, *Marine Air Command and Control System Handbook*, for a detailed discussion on levels of training.

Weapons, Tactics, and Instructor Course

Officers and staff noncommissioned officers who exhibit requisite technical and tactical proficiency may be selected by their units to attend a weapons, tactics, and instructor (WTI)

course. The course is 7 weeks long and held at Marine Corps Air Station, Yuma, AZ and provides advanced training and practical application regarding the planning and execution of the six functions of Marine aviation with specific instruction in the functioning of the MACCS and air defense planning. Course prerequisites include experience in Marine expeditionary force exercises and specific T&R syllabus events. The course is geared toward the mid-level captain/master sergeant who will return to the battalion as the training officer/operations chief. Upon completion of WTI course, graduates are eligible for MOS 7277, weapons and tactics instructor.

Low Altitude Air Defense Enhancement Training Course

This enhanced training course is conducted concurrently with WTI and includes many of the same classes and provides an overview of the six functions of Marine aviation and the MACCS. Students plan and execute approximately 12 separate training evolutions under the supervision of two enlisted instructors and the LAAD division head.

STINGER TRAINING EQUIPMENT

Field Handling Trainer

The Stinger FHT is used at the unit level and Service schools. The FHT has the same size, weight, and external appearance as the Stinger weapon round but is totally inert (see fig. 4-1 on page 4-4). Its controls and mechanical operation are also the same. The Stinger gunner uses the FHT to practice manual skills of weapon handling, operations, sighting, and ranging. The FHT can be used

to visually track live aircraft or a remotely piloted vehicle target system. It allows the gunner to practice mating and removal of the gripstock and insertion and removal of the BCU. Audio indications of target acquisition and IFF responses are not a feature of the FHT.

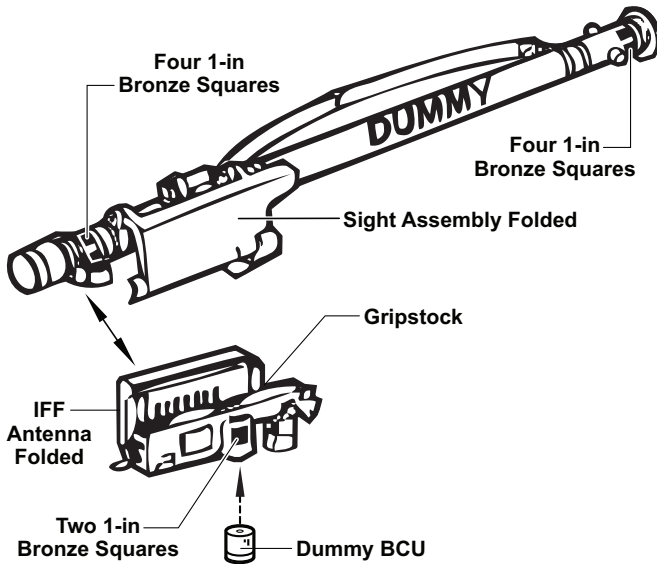

Figure 4-1. Stinger Field Handling Trainer.

Tracking Head Trainer

The Stinger THT consists of THT, five rechargeable nickel cadmium (NiCd) batteries, an IFF simulator with cable, and a shipping and storage container. The THT is used to train gunners in tasks required for engagement of aircraft (see fig. 4-2). It has the same seeker and general appearance as the weapon round except for the performance indicator assembly strapped near the

aft end of the launch tube. The performance indicator assembly provides a means to critique the gunner after target engagement when an engagement is or is not correctly performed. It is used at the unit level for sustainment training, at Service schools to train entry-level personnel, and in the Improved Moving Target Simulator (IMTS) for target engagement. The THT weighs about 38 lbs and its rechargeable battery looks like the battery coolant unit except that it is approximately 3 in longer and twice as heavy. A fully charged battery produces a minimum of 15 training missions (each mission is 47 seconds). The IFF simulator provides the operator with random, simulated IFF interrogation responses. The performance indicator displays the gunner's progress during a simulated engagement. It provides indications that the gunner has correctly performed the engagement sequence

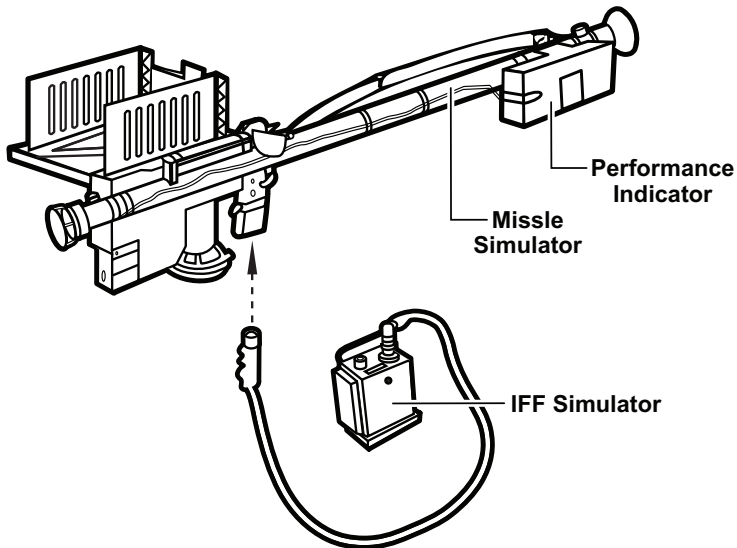

Figure 4-2. Tracking Head Trainer.

or committed a correctable error (e.g., a procedural error that can be corrected before squeezing the firing trigger), committed an uncorrectable error (e.g., squeezing the firing trigger out of sequence), or allowed the 47-second timer to run down, which shuts down the trainer. A benefit of the THT is quality training for operators and the reduction of ammunition expenditures. See Army TM 9-6920-429-12, *Operator's and Organizational Maintenance Manual for Training Set, Guided Missile System M134 NSN 6920-01-024-6946 Training Set, Guided Missile System M160 (RMP) NSN 6920-01-232-2562 Trainer, Captive Flight M67 NSN 6920-01-246-0701 Trainer, Captive Flight Basic NSN 6920-01-305-7525 (Stinger Air Defense Guided Missile System)*, for more information. The THT requires the support of the gas pumping unit (GPU) (see app. E).

Stinger Troop Proficiency Trainer

The Stinger Troop Proficiency Trainer (STPT) is a computer-based device that generates digitized targets and background onto the weapon system's optics (see fig. 4-3). The STPT is used for realistic training of both active and reserve component Stinger

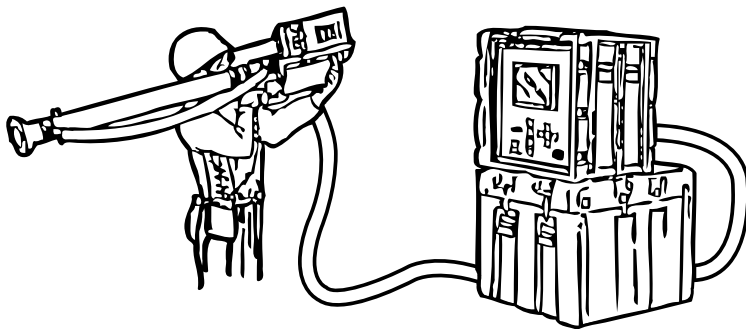

Figure 4-3. Stinger Troop Proficiency Trainer.

gunners in a simulated wartime environment. It eliminates the need for live aircraft, aerial targets, firing ranges, and missile expenditures. The STPT is used for training entry-level personnel and for sustainment training of engagement skills at the unit.

Stinger Improved Moving Target Simulator

The IMTS, AN/FSQ-187, is a computer-driven indoor training facility. The IMTS projects battlefield background scenes and moving aircraft targets on a 360-degree, 12.2-meter diameter hemispherical dome screen to create a realistic battlefield environment (see fig. 4-4). An instructor console located in the dome controls all the scenario selections for video IR projections, sound generation, target maneuvers, and countermeasures. Up to



Figure 4-4. Improved Moving Target Simulator.

three Stinger gunners can be trained simultaneously. When the instructor console is used, student performance evaluations are possible during training exercises. The IMTS is used to train Stinger gunners in target acquisition and engagement skills at the unit level, Service schools, and overseas commands.

Stinger Launch Simulator

The Stinger launch simulator is a low cost, gunner proficiency training device (see fig. 4-5). It has a Department of Defense identification code (DODIC) of VX99. It is comprised of a standard Stinger launcher with an externally-mounted captive seeker. All indications received by the gunner during training are identical to those for the tactical weapon round up to and including launch. The Stinger launch simulator uses an eject motor to launch an inert missile to a range of approximately 170 meters with a maximum altitude of 43 meters. Normal range safety requirements and operating procedures for the Stinger launch simulator are detailed in TM 08319A-12.

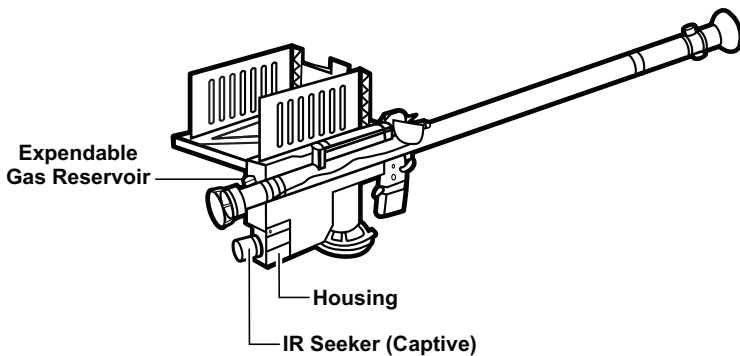

Figure 4-5. Stinger Launch Simulator.

PLATOON, SECTION, AND TEAM TRAINING

Platoon Training

Platoon training should include field and garrison training exercises designed to mold individual sections together to fulfill platoon mission responsibilities. Platoon deployment and redeployment drills along with headquarters and communications exercises should be conducted on a regular basis in accordance with battalion SOPs and MOS-specific handbooks. Platoon training should focus on issuing and receiving a five-paragraph order, platoon-level tactical movement, reporting and communications procedures, integration with other MACCS units, convoy operations, and equipment maintenance.

Section Training

The section is the LAAD battalion's smallest tactical element and is expected to perform their mission separate from the platoon. For this reason, section SOPs should be consistent and thorough. Section level training should include developing leadership and MOS skills for Marines and include all platoon level training plus convoy procedures, section tactical movement, Defense Advanced Global Positioning System Receiver (DAGR) procedures, lost communication actions, communications to include communications security (COMSEC), and operational security to include light discipline.

Team Training

Team training cannot be over-emphasized. The team is where LAAD Marines spend the majority of their time. A closely

cultivated relationship between the team leader and assistant gunner is fostered. Each team member should know the strengths and weaknesses of the other and strive to offset those weaknesses. Teams are dependent upon each other for survival on the battlefield and should possess a strong sense of loyalty. Each team should have a routine that is followed every time they deploy. Though it is not necessary to develop a team SOP, team members should have a clear understanding of their individual and team actions each time they arrive at a position. Marines should attend IMTS training individually and as a team. The team leader should be a mentor to the assistant gunner, developing skills and teaching sound practices for tactical employment. Team training should include section and platoon events and identifying, tracking, and engaging aircraft; reporting procedures; selecting firing positions; and preparing the team for tactical operations.

AIRCRAFT IDENTIFICATION TRAINING

Effective and realistic aircraft identification training is difficult, challenging, and necessary. Marines must be trained to identify aircraft quickly and accurately. Hostile, low-flying aircraft may suddenly appear from behind hills, over trees, or through haze. High-speed aircraft are difficult to identify. Team members should be experts at identifying all friendly and potentially hostile aircraft expected to be operating at low altitudes in a specified combat zone. Aircraft identification training is conducted using real-time video and pictures of the aircraft.

There are various types of aircraft identification training systems available. These systems are interactive computer software

programs designed to increase the gunner's aircraft recognition skills. The program uses 3-D animations, views, photographs, video clips, and line drawings to enhance recognition skills for aircraft from around the world. With current software and hardware upgrades, these systems are continually being improved. These systems also contain a database for testing and scoring aircraft recognition training and can sort aircraft by theater of operation or deployment specific training. Graphic training aids such as printed cards and charts are useful supplements if the CD-ROMs [compact discs read-only memory] are unavailable. A current program for training can be found in Michael J. Gething and Gunter Endres' book series, *Jane's Aircraft Recognition Guide*.

UNIT TRAINING

Unit training is required to prepare the LAAD battalion to perform its wartime mission. Unit training exercises include command post, simulated, and field training. During unit training, LAAD battalion personnel are intimately involved in preparing training plans and coordinating with higher, adjacent, and subordinate command and control and support units. Command post and field training exercise evolutions are generally conducted at the Marine aircraft wing or higher level. Unit participation in MACCS-level training can be accomplished at low cost while maintaining an effective, stimulating forum geared toward MACCS integration training. Examples include the Marine aviation planning problem, MACCS integrated simulated training exercise, and joint Service training exercises. See MCWP 3-25.3 for a more detailed discussion of MACCS-level training opportunities.

EVALUATING TRAINING

The success of individual, team, and section training must be qualitatively measured to identify training deficiencies and create a baseline for future training. Training should be tailored to maintain and improve learned skills and bring identified deficiencies to standards. The Marine Corps Combat Readiness Evaluation (MCCRE) is a key evaluation tool used to identify unit training needs. The MCCRE's standards are a useful tool for designing robust training programs at all operational levels.

TERRAIN WALK

The terrain walk should be completed with leaders first. Then the leader takes the teams on a tour (by foot or vehicle) over a predetermined route. The leader discusses applications of various tactical principles and techniques along the route. This gives the team members an appreciation for tactics or techniques used for Stinger employment. An informal, two-way question and answer session is the most effective method of the terrain walk. A well-conducted terrain walk is an excellent way to implant the tactical concepts of LAAD team support.

TERRAIN MODEL EXERCISE

Terrain model exercises reinforce classroom training of team members before undergoing a practical exercise in the field. Terrain model exercises are actually small tactical exercises where

each team member sees how he/she fits into the whole picture. Terrain model exercises permit leaders to—

- Discuss the role of the supported unit, adjacent units, and other units connected with the field exercise.
- State the mission of the section and teams.
- Discuss unit SOPs for actions on contact, security, and occupying positions.
- Ask questions of each team member.
- Point out terrain features that attack helicopters can slip behind and then attack friendly armored vehicles.
- Answer questions and clear up any misconceptions.

CREW DRILLS

Drills develop teamwork and automatic reaction in time-critical situations. Initially, team members should understand their individual actions and procedures and how they relate to those of the other team members. Next, team members should walk through the procedures with a trained and experienced leader. During the walk through, team members rehearse the crew drill and point out equipment they will use and actions they will perform. These preliminary steps resolve questions and reinforce safety precautions applicable to the system. Stinger TMs list all safety requirements. Crew drills should include Stinger engagements and procedures from the vehicle, in the fighting position, and when on the march completely separated from the vehicle. Crew drills must also include proper wear and procedures for CBRN protective over garments and decontamination procedures for individual equipment, personnel, clothing, and vehicles.

Chapter 5

Support Equipment

ADVANCED MAN-PORTABLE AIR DEFENSE SYSTEM

The A-MANPADS vehicle is usually an M1097A2 or M1165 HMMWV. In addition to being able to shoot and communicate, LAAD units must also be able to move to accomplish their mission. The LAAD teams should deploy with the A-MANPADS whenever possible. Although not a component of the Stinger missile system, the A-MANPADS is a vital part of the weapon system for the Stinger team. Situations that require the team to deploy without the vehicle should be avoided. Without A-MANPADS, the LAAD team is severely restricted and can fulfill only a portion of their mission. If the team must be employed without the vehicle, the platoon commander and section leader must coordinate and plan for the logistic support necessary to conduct the mission. The A-MANPADS allows the LAAD team to keep pace with supported ground forces, rapidly move to alternate positions, reach missile resupply points, carry the basic load of missiles, and carry ancillary equipment and supplies necessary to accomplish the mission.

IDENTIFICATION, FRIEND OR FOE SUBSYSTEM

The IFF subsystem aids in the identification of aircraft and classifies them as either friendly, possible friend, or unknown. It does not identify hostile aircraft. The gunner initiates the IFF sequence by pressing the IFF interrogator switch on the gripstock assembly. Once the gunner issues a challenge, the rest

of the sequence is automatic. The IFF interrogator sends a coded challenge to the aircraft. Aircraft with Mark X or Mark XII transponders will automatically decode the challenge if the interrogator is programmed with Modes III and IV. Mode III is built into the interrogator. If the Mode IV position is used during programming, Mode III (Mark X) will not be challenged until the 2 or 4 days of Mode IV codes have expired. The aircraft's transponder then prepares and sends a coded reply. The reply is received by the IFF antenna and is routed to the interrogator for decoding. The interrogator converts the reply into an audible tone, which is then routed via the interconnecting cable to the gunner as a friendly tone. If the aircraft's transponder sends an incorrect reply to the IFF challenge, the reply is processed by the IFF system into an unknown tone. Aircraft not equipped with the transponders will not reply to the challenge (this is also processed into an unknown tone). The gunner hears the friendly or unknown tone immediately after challenging the aircraft. The IFF challenge is coded in either a complex, crypto-secure Mode IV form or a simpler Mode III form. All US combat aircraft and helicopters have transponders to provide friendly Mode IV and III replies. Some aircraft operating in the combat zone, including US commercial aircraft and some aircraft belonging to our allies, are not Mode IV capable; they are only Mode III capable. Since Mode IV is secure, a friendly Mode IV reply is considered a "true friend." A friendly Mode III reply is considered only as a "possible friend" reply. The IFF support equipment includes the following:

- AN/GSX-1A programmer/battery charger programs the IFF interrogator belt packs and charges the interrogator batteries. Functions may be done separately or simultaneously.
- KIR-1C interrogator computer.
- AN/CYZ-10 data transfer device (DTD) or AN/PYQ-10 Simple Key Loader (SKL).

The computer, electronic transfer device, and the reply evaluator module within the interrogator (when set with classified code), are classified SECRET. They must be safeguarded as outlined in the Secretary of Navy Instruction (SECNAVINST) 5510.30B, *Department of the Navy (DON) Personnel Security Program (PSP) Instruction*; SECNAVINST, 5510.36A, *Department of the Navy (DON) Information Security Program (ISP) Instruction*; and the *EKMS-1A Phase 4 CMS Policy and Procedures for Navy Electronic Key Management System Tiers 2 & 3*. The current electronic key material system callout will contain the specific AKAT tape requirements and instructions. See appendix F for set up and operation of the AN/GSX-1A, loading cryptographic material, and programming of the IFF system.

REMOTE TERMINAL UNIT

The remote terminal unit (RTU) is a ruggedized, Marine-portable, electromagnetic interface shielded laptop computer that displays GBDL-E data information into a recognized air picture for cueing and early warning (see fig. 5-1 on page 5-4). The RTU is designed to be used in the field environment, capable of withstanding a 40 G shock and operating temperatures that range from -40° to 160 °F. The RTU is powered by an internal, replaceable, 6-volt NiCd battery pack. A fully charged NiCd battery pack will provide 3 to 4 hours of operating time in a moderate environment, when the backlight and keyboard are not used. Recharging the NiCd battery pack takes 5 to 6 hours. As an emergency backup to the NiCd battery pack, five D-sized alkaline cell batteries may be used with the RTU. In addition, the RTU can be powered by standard (US) household 120-volt power using the power converter and cables or by 24-volt HMMWV power when using the P4 power cable. Prior to activating the RTU, ensure that

the reset/run switch and store/run switch are both in the run position. See appendix G for a list of set up and operation procedures for the RTU. See TM 10296A-10/1-1 for detailed setup and interface procedures.

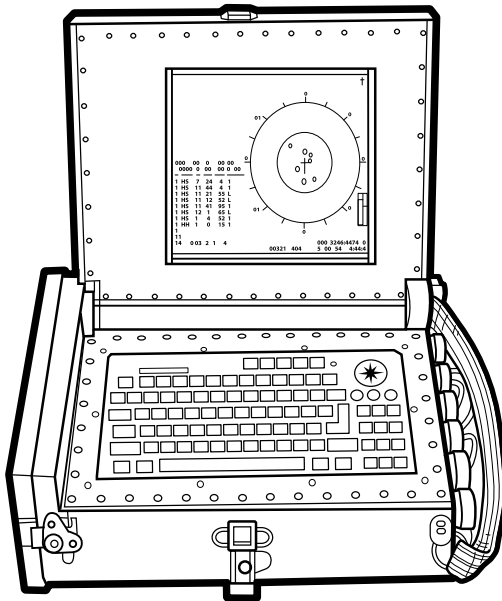

Figure 5-1. Remote Terminal Unit.

**AN/PSN-13, DEFENSE ADVANCED
GLOBAL POSITIONING SYSTEM RECIEVER**

The AN/PSN-13, DAGR is a self-contained, hand-held, 12-channel, dual-frequency continuously tracking Global Positioning System (GPS) receiver (see fig. 5-2). It uses state-of-the-art GPS

receiver technology including “All in View” satellite tracking and the selective availability anti-spoof module to access the precise positioning service signal for highly accurate position, navigation, and timing information 24 hours a day under all weather conditions. Although designed as a hand-held receiver for ground mobile and airborne troops, standardized interfaces enable DAGR to provide position, navigation, and timing information to a wide variety of vehicles and host systems including integrated configurations for position location, target location, rendezvous en route, and terminal navigation (see app. H). The DAGR supplements and replaced the Precision Lightweight Global Positioning System Receiver (PLGR), a five-channel GPS receiver first fielded in 1994. The DAGR provides ICD-GPS-153C and NMEA 0183 compliant serial data interfaces for weapon system integrations including laser range finders.

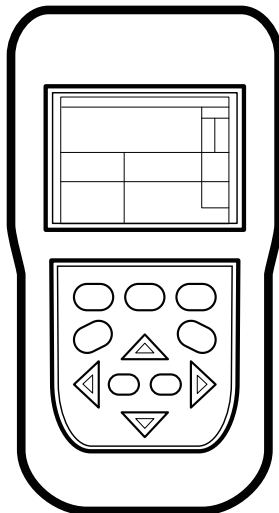

Figure 5-2. AN/PSN-13, Defense Advanced Global Positioning System Receiver.

OPTICAL DEVICES

AN/PAS-18, Receiver, Infrared System

The AN/PAS-18, receiver, IR system is a rugged, lightweight, thermal imaging sight that easily mounts directly on the Stinger missile round to provide 24-hour mission capability (see fig. 5-3). Operations at night or in adverse weather conditions are also aided with the AN/PAS-18. Although this device aids in target acquisition and identification, gunners must first be able to see a target; acquire the target; and, in specific weapons conditions, positively identify targets prior to the engagement process. The PAS-18 allows the Stinger firing team to perform target acquisition and weapon firing during total darkness and under reduced visibility conditions due to fog, dust, and smoke. The

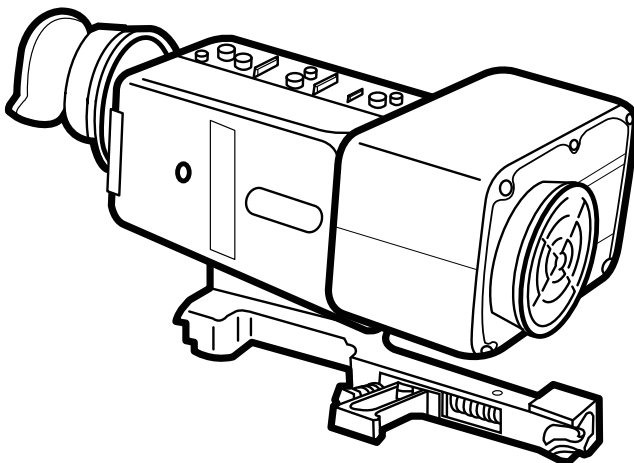

Figure 5-3. AM/PAS18, Receiver, Infrared System.

AN/PAS-18 can track a fixed-wing target (tail-end aspect) in excess of 30 km away from the Stinger position; in the worst-case scenario (nose-front aspect), 8 to 10 km toward the Stinger team's position. Identification of aircraft with the AN/PAS-18 is difficult and positive visual ID should not rely on the AN/PAS-18 receiver alone. Differentiation between fixed-wing and rotary-wing aircraft can be made between 3 to 5 km. The AN/PAS-18 has a reticle electronically displayed on the image screen that matches the open sight assembly and the range ring is factory bore sighted to match that of the weapon round. The range ring displayed within the AN/PAS-18 cannot, however, be used for range determination as with the open sight assembly. The primary power source is a disposable lithium battery (BA5847/U) that provides 12 hours of operation. The AN/PAS-18 is equipped with a low battery indicator located in the upper left corner of the display screen; the battery low icon flashes when the internal battery is approximately 15 minutes from depletion. For continuous 24-hour operations, the alternative power source is the vehicle power adapter. The vehicle power adapter consists of a power converter with two connectors, one for power in and the other for power out. See TM 09688A-10&P, *Operation and Maintenance Instruction with Parts List AN/PAS-18, Receiver Infrared System Part Number 4006149-1 NSN 6685-01-356-6542*, for further details.

AN/PVS-7B, Night Vision System

The AN/PVS-7B, night vision system is a single-tube night vision goggle (NVG), third generation image intensifier that uses prisms and lenses to provide the user with simulated binocular vision (see fig. 5-4 on page 5-8). The AN/PVS-7B incorporates a high light level protection circuit in a passive, self-contained image intensifier device that amplifies existing

ambient light to provide the operator a means of conducting night operations. A shipping case, soft carrying case, eyepiece, objective lens cap, and filter are ancillary items. A demist shield is also provided to prevent fogging of eyepiece. AN/PVS-7B operates for 12 hours on one 2.7-volt Mercury, NiCd, or Lithium battery (BA-5567 or AA cells).



Figure 5-4. AN/PVS-7B, Night Vision System.

AN/PVS-14, Monocular Night Vision Device

The AN/PVS-14 monocular night vision device uses a third generation image intensifier tube and is often used “hands free” using a head harness or attached to a combat helmet such as the personnel armor system ground troop helmet, advanced combat helmet, or Marine lightweight helmet. The AN/PVS-14 operates for approximately 50 hours (at room temperature) on two AA batteries (see fig. 5-5).



**Figure 5-5. AN/PVS-14,
Monocular Night Vision Device.**

AN/PAS-13, Thermal Weapon Sight

The AN/PAS-13, thermal weapon sight is a lightweight, low power, high performance forward-looking infrared device that will augment existing crew-served night vision sights (see fig. 5-6). The thermal weapon sight is completely passive and although



Figure 5-6. AN/PAS-13, Thermal Weapon Sight.

primarily designed for target detection and engagement with individual crew-served weapons, it can also be used for all weather surveillance. The medium weapon thermal sight (AN/PAS-13B[V]2) can effectively engage targets out to 1000 meters while mounted on the M249 squad automatic weapon or M240B medium machine gun. The heavy weapon thermal sight (AN/PAS-13B[V]3) can effectively engage targets out to 2000 meters while mounted on the M2 heavy machine gun or the MK19 40mm machine gun. Both systems operate with one BA-5347/U (Go To War) or one BB-2847/U (rechargeable) battery.

COMMUNICATIONS EQUIPMENT

AN/VRC-91D, Man-pack/Vehicular Radio Set

The AN/VRC-91D, man-pack/vehicular radio set is a vehicle-mounted, dual-radio configuration consisting of one long-range and one short-range dismountable, solid-state, securable transceiver for VHF-frequency modulation tactical operations (see fig. 5-7). The AN/VRC-91D provides long-range dismountable (up to 35 km) and short-range dismountable (up to 8 km) operation simultaneously in two nets. The AN/VRC-91D vehicular, long-range/short-range man-pack configuration provides maximum flexibility. The AN/VRC-91 transmits over a frequency range from 30 to 87.975 MHz using the AS-3683/PRC (tape), AS-4266/PRC (whip) or AS-3900/3916 (vehicle) antennas. Transmit distances for the AN/VRC-91 are high power, voice 5 to 10 km; voice with power amplifier, 10 to 40 km; data high power data, 3 to 5 km; and data with power amplifier, 5 to 25 km. Power for the system is supplied by the standard vehicle power source (27.5 VDC).



**Figure 5-7. AN/VRC-91D,
Man-pack/Vehicular Radio Set.**

AN/MRC-148, High Frequency Vehicular Radio

The AN/MRC-148, high frequency vehicular radio is a multi-component system used for long-haul, beyond line of sight communications between the battalion, firing batteries, and higher headquarters/external agencies (see fig. 5-8 on page 5-12). The AN/MRC-148 was the direct replacement for the AN/MRC-138 and provides 150 watts peak envelope power/average in the HF portion of the frequency range (1.6 to 29.99999MHz) and 60 watts peak envelope power/average for the VHF portion (30 to 59.99999 MHz) in a mobile configuration. The AN/MRC-148 system consists of the following components:

- AN/PRC-150 (C) radio.
- Vehicle automatic antenna tuner.
- Vehicle HF whip antenna mount.
- 150W vehicle configuration.



**Figure 5-8. AN/MRC-148,
High Frequency Vehicular Radio.**

AN/PRC-150, High Frequency Man-pack Radio

The AN/PRC-150, high frequency man-pack radio is an advanced HF-SSB/VHF-FM man-pack radio that provides reliable tactical communications through enhanced secure voice and data performance, networking, and extended battery life. See figure 5-9. In addition to the HF capability, the transceiver's extended frequency range, up to 60 MHz, provides secure frequency shift key 16 kbps continuous variable slope delta voice and data in the VHF band. The AN/PRC-150 has a frequency range from 1.6 to 59.9999 MHz and transmits at distances of 48.2 km with the OE-505 (1 m) antenna or 482 km with the radio frequency (RF)-1936(AS-2259) antenna. The AN/PRC-150 standard power source is 20 to 32 VDC and is achieved with 2 BA-5590 batteries, lasting 22 to 26 hours or 2 BB-590 batteries, lasting 2 to 4 hours.

Note: Do not combine a rechargeable BB-590 battery with a BA-5590 in the same piece of equipment.



**Figure 5-9. AN/PRC-150,
High Frequency Man-pack Radio.**

AN/PRC-117F(V)1C, Radio Set, Multi-band, Falcon II

The AN/PRC-117F(V)1C, radio set, multi-band, Falcon II is an advanced multi-band, multi-mission man-pack radio providing reliable and tactical communications performance in a small, lightweight package that maximizes user mobility (see fig. 5-10). The AN/PRC-117F(V)1C operates from either two BB-590/U NiCd rechargeable batteries, two BA-5590/U lithium batteries, two BB-390A/U Ni-MH rechargeable batteries, or two BB-490/U lead-acid rechargeable batteries. The AN/PRC-117F(V)1C frequency range is continuous from 30.000 MHz to 511.999 MHz, providing amplitude modulation (AM) and FM and various data waveforms. AN/PRC-117F(V)1C provides line of sight (LOS), electronic counter countermeasures (ECCM), satellite communications, frequency hop operations SINCGARS and HAVEQUICK and compatible with all tactical VHF/UHF radios.

Note: Do not combine a rechargeable BB-590 battery with a BA-5590 in the same piece of equipment.



**Figure 5-10. AN/PRC-117 F(V)1C,
Radio Set, Multi-band, Falcon II.**

AN/PRC-119(A-F), Single-Channel Ground and Airborne Radio System Man-pack Radio

The AN/PRC-119(A-F), SINCGARS man-pack radio possesses an operating mode that includes a single channel, frequency hopping internal ECCM module, and it has a maximum output of 4 watts and 2320 channels (see fig. 5-11). Capable of preset frequency scanning between 30 to 87.975 MHz, the radio has a transmit range of high power voice from 5 to 10 km and high power data from 3 to 5 km. The frequency ranges defined here are for planning purposes only. They are based on LOS communications with the AS-3683/PRC (tape) or AS-4266/PRC (whip) antennas and are averages for normal conditions. The use of

the OE-254 antenna (not SL3 to the AN/PRC-119) increases range for both voice and data transmissions. The AN/PRC-119(A-F) uses a 12 VDC battery power source, one BA-5590, a memory power source, and one BA-5372U. The standard capability for the BA-5590 is approximately 22 to 26 hours and the BA-5372U is approx 6 months. Transmit to receive ratio, output setting, and ambient temperature can reduce battery life.



Figure 5-11. AN/PRC-119 (A-F), Single-Channel Ground and Airborne Radio System Man-pack Radio.

AN/VRC-110, Dual Vehicular Adapter

The AN/VRC-110, dual vehicular adapter is a fully integrated, high-performance, dual-multiband vehicular radio system comprised of the AN/PRC-152(C) software communications architecture-based hand-held radio, power amplifier, and integrated hand-held battery charger (see fig. 5-12 on page 5-16). The system can be configured for hand-held or vehicular applications and transmits voice and data within the AM-FM-VHF-UHF frequency bands from 30 to 512 MHz at LOS distances up to 19.3 km. Power for the system is supplied by the standard vehicle power source (27.5 VDC). The AN/VRC-110 is replacing the AN/VRC-88, -89, -90, and -91 radio systems within the LAAD battalion support vehicles. The AN/VRC-110 does not support GBDL-E and should not be used in the A-MANPADS or section leader vehicles.



Figure 5-12. AN/VRC-110, Dual Vehicular Adapter.

AN/PRC-152, Tactical Hand-held Radio

The AN/PRC-152, tactical hand-held radio is a standardized, lightweight, tactical, hand-held radio that provides secure, multi-band communications in the 30 to 512 MHz (AM and FM) frequency spectrum up to 19.3 km (see fig. 5-13). The system can be configured for hand-held (AN/PRC-152) or vehicular (AN/VRC-110) applications. The AN/PRC-152 contains embedded type I COMSEC and is interoperable with SINCGARS and HAVEQUICK II in the single-channel and the ECCM frequency hopping modes.



Figure 5-13. AN/PRC-152, Tactical Hand-held Radio.

OK-648/U, Control Group Radio

The OK-648/U, control group radio provides for remote control operation of SINCGARS radios (see fig. 5-14 on page 5-18). The remote control unit (RCU) is connected with the radio by two-way field wire and may be located up to 4 km away from the remotely controlled radio. The RCU is capable of sending and receiving voice and data messages in plain or cipher text. The controls, features, and operations of the RCU are similar to that of the SINCGARS radio.



Figure 5-14. OK-648/U, Control Group Radio.

RF-5800R-RC111, Remote Control System

The RF-5800R-RC111, remote control system with high-speed interface (HSI) provides full remote control capability for the Falcon II family of man-pack radios (see fig. 5-15). In addition to providing remote transmit and receive audio, data and control up to distances of 3.5 km using standard field wire, the HSI provides



**Figure 5-15. RF-5800R-RC111,
Remote Control System.**

a RS-449/V.36 interface. This interface accommodates a wide variety of data link options when combined with commercial off-the-shelf equipment such as multiplexers, fiber modems, and microwave systems. The RF-5800R-RC111 with high-speed interface allows the connection to external data transmission mediums, including microwave, T1/E1, fiber optic modem, etc. Additionally, the volume control settings have been mapped to the volume control of the Harris man-pack radios. All of the radio functions controlled by the keyboard display unit are available at the RCU and include automatic link establishment, frequency hopping, and modem selections. The system supports the full range of data applications such as the RF-6700 series of data and imaging applications and HF tactical chat. An engineering orderwire intercom function is available between the remote and local operators. It includes a local control unit RF-5800R-RC102, an RCU RF-5800RRC103, two HSIs, a handset, an interconnect cable, manual and operator cards, and a carrying bag. The remote control unit is powered by batteries or an RF-5850-PS002 battery eliminator. Both the RCU and local control unit have visual indicators to display link status, engineering orderwire call, and error indication or battery status.

AN/GRA-39, Radio Terminal Set

The AN/GRA-39, radio terminal set enables an operator to transmit and receive voice communication through a radio set from a distance up to approximately 3.3 km from the radio set (see fig. 5-16 on page 5-20). A push-to-talk circuit permits the radio in the system also to be operated by a local battery switchboard and the telephones connected to the switchboard. Voice communication of the radio is initiated through either the remote control unit or the local control unit. The AN/GRA-39 is powered by six BA-30/30 batteries that last approximately 24 hours.



Figure 5-16. AN/GRA-39, Radio Terminal Set.

TA-312/PT, Telephone Set

The TA-312/PT, telephone set is used as a local battery or common battery manual telephone (see fig. 5-17). It may be arranged for operation as a local battery using common battery signaling. It can be used under all outdoor conditions or used as a desk or wall-



Figure 5-17. TA-312/PT, Telephone Set.

mounted telephone. A receptacle is provided for connecting a hand-set-head-set which may be used in place of the handset provided. The TA-312/PT can also be used to control remotely-operated radio equipment by operation of the push-to-talk switch on the telephone handset. It requires two BA-3030 D-cell batteries.

COMMUNICATIONS SECURITY EQUIPMENT

AN/CYZ-10, Data Transfer Device

The AN/CYZ-10(V)2, -10(V)3, DTD, often called the "Crazy 10," is a battery-powered, hand-held unit capable of receiving, storing, and transferring data between compatible equipment (see fig. 5-18 on page 5-22). The primary application is the transfer of variable-length electronic keying material, frequency hopping data, and other COMSEC-related variables. The DTD offers programming capabilities to preclude the need for developing other system-unique requirements. The DTD is programmable, which makes it capable of performing the system-specific functions of current common fill devices. The DTD also fully supports the new generation of embeddable information security devices currently being developed. The DTD is made user friendly by the extensive use of menus. Interaction between the DTD and the operator is via the 35-key keyboard (full keypad, NSN 5810-01-347-9121) or the 13-key keyboard (limited keypad, NSN 5810-01-348-4673) and the 2- by 24-character window in the liquid crystal display. The DTD interface is a standard 6-pin audio connector, and the DTD contains a receptacle for inserting the cryptographic ignition key. The cryptographic ignition key is used to control access to the secure domain based on the data stored in the key. Data to the key is serially read or written under control of the dual processor. The

DTD performs various built-in test functions. The built-in test is designed to test the functionality of the DTD to a high level of confidence in the host and COMSEC sections. The major difference between the AN/CYZ-10(V)2 and the AN/CYZ-10(V)3 is the software used. The DTD is powered with three BR-2/3 ASSP or one DL123A batteries.



Figure 5-18. AN/CYZ-10, Data Transfer Device.

AN/PYQ-10 Simple Key Loader

The AN/PYQ-10 SKL is a portable, hand-held fill device for securely receiving, storing, and transferring data between compatible cryptographic and communications equipment. Developed by SAIC under the auspices of the US Army and the National Security Agency, it is intended to eventually replace the AN/CYZ-10 DTD (see fig. 5-19). The PYQ-10 provides all the

functions currently resident in the CYZ-10 and incorporates new features that provide streamlined management of COMSEC key, electronic protection data, and signal operating instructions. The SKL is backward-compatible with existing end cryptographic units and forward-compatible with future security equipment and systems. The SKL uses a Windows-based platform. It is similar to a tablet PC [personal computer] in that it uses a small plastic stylus to move the mouse around the screen and perform the 'click' action. TM 11-5810-410-13&P, *Technical Manual Operators and Field Maintenance Manual Including Repair Parts and Special Tools List for Transfer Unit, Cryptographic Key AN/PYQ-10 (C) Simple Key Loader (SKL) SKL UAS Version 4.0 (NSN 5810-01-517-3587) (EIC: N/A)*, contains more detailed information.



Figure 5-19. AN/PYQ-10 SKL.

ANTENNAS

AS-2259/GR, Antenna

The AS-2259/GR, antenna is a crossed sloping, dipole antenna fed with a low loss, foam-dielectric, coaxial mass that also serves as a supporting structure (see fig. 5-20). The antenna mast consists of eight lightweight coaxial mast sections held in the vertical position by the four radiating elements serving as mast guys.

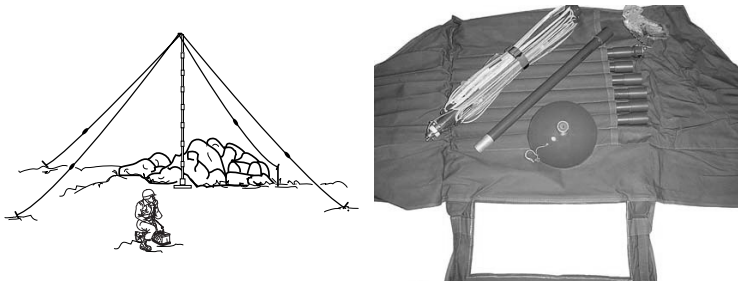

Figure 5-20. AS-2259/GR, Antenna.

OE-254/GRC, Antenna

The OE-254/GRC, antenna group is an omni-directional, biconical antenna designed for broadband operation without field adjustment from 30 to 88 MHz, up to 350 watts (see fig. 5-21). The OE-254/GRC is intended for use with the SINCGARS family of radios. The antenna group is stowed in a transit bag and includes spare antenna elements, guy assemblies, guy plates and the stake assembly. Instructions for detailed assembly and erection procedures and stowing instructions are in the bag.

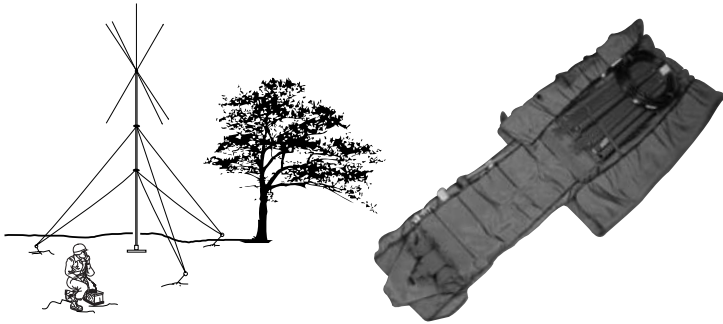

Figure 5-21. OE-254/GRC, Antenna.

Appendix A
LOW ALTITUDE AIR
DEFENSE STATUS BOARD

Appendix B

Low Altitude Air

Defense Team Mount-Out Guide

This appendix includes information relative to administrative, operational, and logistic matters. It is not all-inclusive, but provides a starting point for a deployment or operation. The five-paragraph order (see app. C) provides a means to pass this information to team personnel. The team leader must acquire and analyze all information necessary to conduct operations as it relates to the team and its mission. The team leader must fully understand the supported unit's mission, commander's intent, scheme of maneuver, and be thoroughly familiar with the supported unit commander's air defense requirements. To provide effective air defense, the team leader must understand the team's relationship to the MACCS and communications links with appropriate units and agencies. Specific information requirements for the team include the following:

- Supported unit mission and team mission.
- CBRN threat information.
- Supported unit scheme of maneuver.
- Ground and/or air threat.
- OPORD and SOP.
- Maps and charts.
- Unit location or alternate location.
- Route or alternate route.
- Hostile criteria, ROE, and RTF procedures.
- Air defense warning condition, SOA, and WCS.

MCRP 3-25.10A

- Sector of fire and PTL.
- Manual cross tell procedures.
- Challenge and/or password.
- Call signs and communications nets and frequencies.
- Lost communications procedures.
- Restoration of communications nets.
- Handling prisoners of war.
- MACCS agency or agencies.
- Friendly troops in operating area or free fire zone.
- Rally points or loiter times.
- Release points.
- Weather report.
- Emission control procedures.
- Retrograde procedures.
- Reporting procedures.
- Resupply (missiles and logistics).
- Medical support.
- BDZ procedures (as applicable).
- Appropriate operational and Service publications.
- Fire support coordination lines.

After acquiring all necessary information, the team determines the personal 782 gear and operational equipment required based on METT-T. See the following table for specific equipment requirements, these requirements are not all-inclusive. Team members should also ensure that the required equipment is secured within the A-MANPADS vehicle (see fig. B-1 on page B-5).

Table B-1. Equipment Requirements.

Equipment	Quantity
Vehicles:	
M1097/M1165 A-MANPADS	1
SL-3/pioneer gear	1 set per vehicle
.50 cal, M2/M240B	1 per vehicle
Armory:	
M-16A4/M4 w/bayonet	1 per gunner
Compass	1 per team leader
Binoculars	1 per team
AN/PVS-7B NVGs	2 per team
Supply:	
MREs	1 case per Marine
Cammie net/cammie poles	1 set
ILBE pack	1 per Marine
BC-5 or team box	1 per team
5-gallon water can	1 per Marine
5-gallon gas can	2 per team
782 gear	1 per Marine
Communications:	
AN/VRC-91 SL-3 complete	1 per vehicle
AKAK-1553	1 per team
BA-5590/BB-590	3-day supply
BA-30/30 D-Cell	3-day supply
BA-3058/U AAs	3-day supply
BA-5847/U	3-day supply
BA-5567/U NVGs	3-day supply
AN/PSN-13A(DAGR)	1 per team
DR-8 roll (field wire)	1 per team
Administrative:	
Record books, pens, paper, etc.	1 set
CBRN:	
Chemical protective over garment	2 per Marine
M40 field mask	1 per Marine
M-11 vehicle decontamination set	1 per vehicle
M-291 personal decontamination kit	2 per Marine
NAAK	3 per Marine

Table B-1. Equipment Requirements. (Continued)

Equipment	Quantity
Stinger: AN/PPX-3 A/B belt pack AN/PAS-18 Stinger night sight RTU SL-3 complete	2 per team 1 per team 1 per vehicle
Weapon rounds (FIM-92-C)	2 per team
Missile rounds (FIM-92C)	2 per team
Complete complement of ground ammo: 5.56mm (DODIC: A059) 9mm (DODIC:A363) 7.62mm (DODIC: A131) .50 cal (DODIC: A576)	Per SOP
AT-4s	As assigned
Mines/boobytraps	As assigned
Hand grenades (WP/smoke/frag/CS/illum)	Per SOP
Legend CS- 2 chlorobenzalmalononitrile (also known as tear gas) frag fragmentation ILBE Improved Load Bearing Equipment illum illumination MREs meals, ready to eat WP white phosphorous	

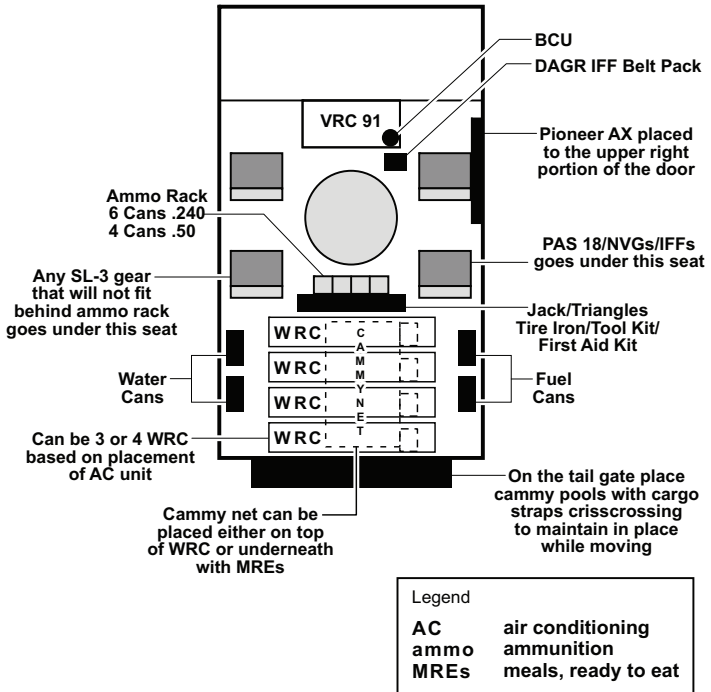

Figure B-1. Advanced Man-Portable Air Defense System Equipment Placement.

Appendix C

Operational Reports, Requests, and Orders

Standardized reports, requests, and orders are essential to ensure that each Marine performs in the same manner and deviates from procedure only as needed. These reports, requests, and orders are based upon tactics, techniques, and procedures developed to support LAAD requirements. The items found in this appendix may be changed depending on higher headquarters requirements and the SOP.

Reports are categorized as flash and routine. Flash traffic reports take precedence over all radio nets when being transmitted to higher headquarters or a distant station. Routine reports are of a routine nature and reported to higher headquarters as time permits and information is gathered. The unit SOP will determine which of these reports are categorized as flash or routine.

Leaker Report

Date-Time Group of Report: _____

1. Number and Type of Aircraft
2. Location and Heading
3. Time (if not immediate)

**SALUTE [Size, Activity,
Location, Unit, Time, and Equipment] Report**

Date-Time Group of Report: _____

1. Size

(S) Squad

(P) Platoon

(C) Company

(B) Battalion

(O) Other (specify): _____

2. Activity

(O) Offensive

(D) Defensive

(C) Convoy

(OT) Other (specify): _____

3. Location _____ (military grid reference
system latitude/longitude)

4. Unit

(M) Mechanized Infantry

(DI) Dismounted Infantry

5. Time Seen _____

6. Equipment

(AC) Aircraft on Deck

(S) Semi-Auto Machine Gun

(A) Antitank Weapons

(M) Mines

(T) Tanks

(ART) Artillery

(TR) Trucks

(B) Boats

(O) Other (specify): _____

7. Additional Comments _____

Nuclear, Biological, and Chemical-1 Report

Date-Time Group of Report: _____

1. Type of Report

(N) Nuclear

(B) Biological

(C) Chemical

2. Position of Observer (_____ military grid
reference system direction of attack _____
[relative to observer's position])

Direction: _____ (degrees)

3. Date-time group attack began/ended _____ / _____

4. Location of Attack _____ (military grid
reference system)

5. Means of Delivery

(A) Aircraft

(ART) Artillery

(M) Missile

6. Type of Burst

(A) Air

(S) Surface

(SUB) Subsurface Spray

7. Type of Agent

(N) Nerve

(B) Blister

(BL) Blood

(C) Choking

(I) Irritant

(U) Unknown

8. Additional Comments _____

Medical Evacuation/Casualty Evacuation Request

Medical evacuation/casualty evacuation requests will be completed using the assault support request form per MCWP 3-24, *Assault Support*. Guidance on submitting the assault support request is provided in MCWP 3-25.5, *Direct Air Support Center Handbook*.

Joint Tactical Air Strike Request

Requests for close air support will be completed using Department of Defense Form 1972, *Joint Tactical Air Strike Request* (see JP 3-09.3, *Close Air Support*, for instructions). Guidance on submitting a joint tactical air strike request is provided in MCWP 3-25.5.

Engagement Report

Date-Time Group of Report: _____

1. Unit Call Sign
2. Number and Type of Aircraft Engaged
3. Time of Engagement
4. Location (as per the reference system used)
 Cartesian Grid _____
 Military Grid Reference System _____
 Latitude/Longitude _____
5. Number of Missiles Expended
6. Result (kill, miss, or damage)

Air Defense Status Report

Date-Time Group of Report: _____

1. Air Defense Warning Condition

(W) White

(Y) Yellow

(R) Red

2. Weapons Control Status

(F) Free

(T) Tight

(H) Hold

3. States of Alert

(A) Battle Station

(B) 5-Minute Alert

(C) 1-Hour Alert

(D) 4-Hour Alert

4. Effective Date-Time Group _____

Frequency Interference Report

Date-Time Group of Report: _____

1. Type of Report
2. Unit Location and Time
3. Frequency Affected
4. Equipment Affected

(FM) Radio/VHF

(N) Navigational Aid

(S) SAT Comm.

(AM) AM Radio/HF

(R) Radar

(O) Other Specify: _____

5. Strength of Interference

Weak

Medium

Strong

6. Comments or Amplifying Instructions _____

Movement Order

Date-Time Group of Report: _____

1. Relocation Position Grid _____

2. Time Released from Current Mission _____

3. Time to be Operational (in Date-Time Group) _____

4. Comments/Instructions _____

Low Altitude Air Defense Status/Logistics Report

Date-Time Group of Report: _____

1. Personnel _____
2. Missiles
 - a. Number Optional
 - b. Number Nonoperational
 - c. Number Needed
3. Identification Friend or Foe
 - a. Number Operational
 - b. Number Nonoperational
 - c. Comments and Specific Problem
4. Remote Terminal Unit Ground-Based Data Link
 - a. Up
 - b. Down
 - c. Comments and Specific Problems
5. Vehicle
 - a. Up
 - b. Down
 - c. Comments and Specific Problems
6. Cryptographic Type _____
 - a. Up
 - b. Down
 - c. Comments and Specific Problems

MCRP 3-25.10A

7. Petroleum, Oils, and Lubricants Resupply

- a. Diesel/JP8 _____ gal
- b. Oil _____ gal
- c. White Gas _____ gal
- d. Anti-Freeze _____ gal
- e. Brake Fluid _____ gal
- f. Cleaner Lubricant Protectant
- g. Other (specify)

8. Water ____ gal

9. Battery Type____ Number Needed____
Type____ Number Needed____
Type____ Number Needed____
Type____ Number Needed____
Type____ Number Needed____

11. Ammo Type____ Amount Needed____
Type____ Amount Needed____
Type____ Amount Needed____
Type____ Amount Needed____
Type____ Amount Needed____

12. Subsistence (cases of MREs) _____

13. Location and Time for Resupply _____

14. Comments and Special Instructions _____

FIVE-PARAGRAPH ORDER

This is a sample format five-paragraph order. It is not inclusive. The team leader should be familiar with the five-paragraph order format and all essential information required for completing the mission. It is also the responsibility of the team leader to ensure the assistant gunner is informed on all aspects of the mission, ROE, and tasks to be accomplished and to acquaint subordinates with the operating area to include key terrain, site location, adjacent unit locations, Marine tactical air command center (TACC), TAOC, DASC, FOBs, etc., and expected axes of attack.

1. () Situation

a. () General. Address current situation to include a big picture comparison of enemy versus friendly locations. Address MAGTF air defense priorities and current weather and its effects on operations.

b. () Enemy Forces. Address enemy forces and capabilities with respect to friendly IADS capabilities.

(1) () Ground forces disposition.

(2) () Aircraft number and type (include unmanned aerial systems).

(3) () Expected threat axis and likely avenues of approach.

(4) () Expected times of attack.

(5) () Ordnance types/delivery techniques.

- (6) () Electronic attack and/or electronic warfare support capabilities.
- (7) () IRCCM capabilities.
- (8) () CBRN capabilities.
- (9) () Night capabilities.
- (10) () Surface-to-surface threat.
- (11) () Special operations and/or terrorist threat.
- (12) () Most likely enemy course of action.

c. () Friendly Forces

- (1) () Higher. Include battalion combat operations center (COC), early warning/control, TAOC, Marine TACC.
- (2) () Adjacent. Include ground combat element, logistics combat element, and Stinger.
- (3) () Supporting. Address as appropriate.

d. () Attachments and Detachments

- e. () Assumptions. Based upon operational plans.

2. () Mission

3. () Execution

- a. () Commander's intent.
- b. () Concept of operations.
- c. () Tasks.

- d. () Reserve.
- e. () Coordinating instructions.
- f. () Time of departure/time to be operational.
- g. () Initial air defense warning conditions, WCS, SOA.
- h. () Initial mode of control (centralized, decentralized).
- i. () Engagement direction authority (TAOC, Airborne Warning and Control System, airborne early warning, etc.).
- j. () Autonomous operations.
- k. () Visual combat air patrol, BDZ, MEZ, fighter engagement zone locations.
- l. () Surveillance gaps.
- m. () Primary threat axes.
- n. () RTF, MRRs, ROE, and ID criteria.
- o. () Firing doctrine guidance (specific with respect to single targets, raids, jammers, and maneuvering and/or nonmaneuvering targets).
- p. () LAME DUCK procedures.
- q. () Self-defense criteria.
- r. () Manual cross tell procedures.
- s. () Casualty plans.
- t. () Liaison requirements.
- u. () Alternate site locations.
- v. () Consolidation points.
- w. () CBRN MOPP conditions and decontamination plans.

4. () Administration and Logistics

- a. () Water and rations.
- b. () Petroleum, oils, and lubricants.
- c. () Missile resupply and/or ammunition (include initial missile load out).
- d. () Location of corpsman and/or medical evacuation procedures.
- e. () Handling of enemy prisoners of war.
- f. () Equipment maintenance.

5. () Command and Signal

a. () Command

- (1) () Location and next higher unit leader's location.
- (2) () Succession of command.

b. () Signal

- 1. () Current period for ACEOI [automated communications-electronics operating instructions].
- 2. () Frequencies and/or call signs (priority/alternate).
 - (a) () Required communications nets.
 - (b) () Prioritization and restoration of communications nets.
 - (c) () Data link reference points and battery address (including information for ground-based data link).

- (d) () Lost or alternate communications procedures.
- (e) () Required reports (times required).
- (f) () Frequency, call sign, and/or cryptographic change over times.
- (g) () Challenge and/or password.
- (h) () Brevity codes.
- (i) () Emission control and/or electronic protection procedures.
- (j) () Plan for air tasking order distribution.

Time Hack

WARNING ORDER

The warning order is an abbreviated version of the five-paragraph order. It is used to give advanced notice to personnel. Follow unit SOP in the generation of the warning order.

EXPLOSIVE ORDNANCE DISPOSAL 9 LINE

1. Date-Time Group Discovered
2. Unit, Grid, Landmark
3. Frequency, Point of Contact Call Sign
4. Type and Amount of Ordnance, How it was Emplaced
5. Nuclear, Biological, Chemical Threat of Ordnance
6. Assets Threatened
7. Impact on Mission
8. Protective Measures Taken
9. Recommended Priority (response)

CONTACT REPORT

1. Call Sign
2. Occurrence (what is happening)
3. Need Requested
 - a. Immediate Support
 - b. Medical Evacuation
 - c. Reinforcement
4. Time and Location
5. Action taken (DRAWD)
6. Casualties Sustained (FKIA [friendly killed in action]/FWIA [friendly wounded in action] and EKIA [enemy killed action]/EWIA [enemy wounded in action])

CALL FOR FIRE REQUEST

1. *__(call sign of artillery support)__* this is *__(your call sign)__*; type of mission (adjust fire/fire for effect), over.
2. Grid _____ distance _____ meters.
3. Target description/number type.
4. Adjust fire/fire for effect/danger close.

Note: For adjusting fire use the following procedure: *__(call sign of artillery support)__* this is *__(your call sign)__,* add/drop (in meters) _____ left/right _____, over. Continue to adjust fire until effect on target is achieved then request “fire for effect.”

Return damage assessments afterwards.

Appendix D

Operational Communications

The ability for gunners to communicate incoming orders or outgoing reports and requests is paramount to the successful deployment of equipment and personnel in support of the air defense mission. The LAAD gunners can find themselves positioned in support of various agencies, internal and external to components of the Marine air control group, and must know how to communicate with them. See figure D-1 for the LAAD communications architecture and table D-1 for LAAD communications networks.

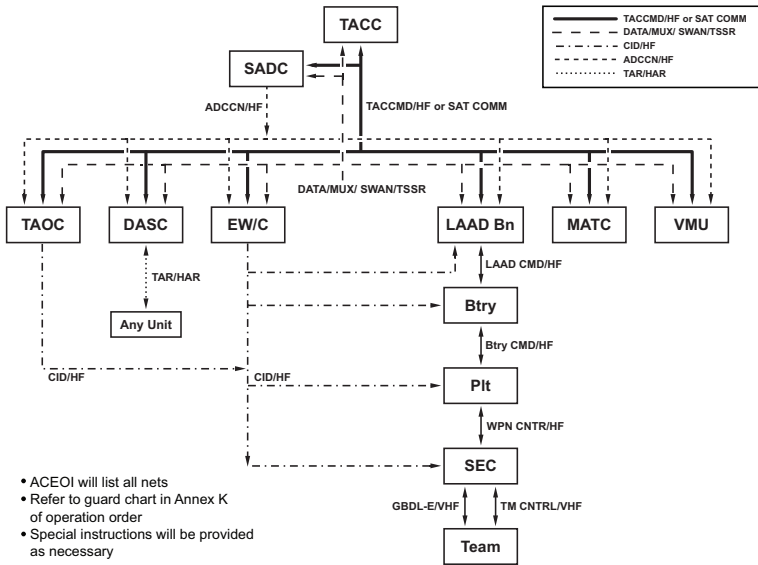

Legend	
ACEOI	automated communications-electronic operating instructions
ADCCN	air defense command and control net
Btry	battery
Bn	battalion
CID	combat information
CMD	command
CNTRL	control
COMM	communication
EW/C	early warning/control
HAR	helicopter air request
MUX	multiplexer
Plt	Platoon
SADC	sector air defense commander
SAT	satellite
SEC	section
SWAN	Secure Wide Area network
TACC	Tactical Air Command Center (USMC)
TAR	tactical air request
TACCMD	tactical command
TSSR	tropographical/satellite support radio
VMU	Marine unmanned aerial vehicle squadron
WPN	weapon

Figure D-1. Low Altitude Air Defense Communications Architecture.

**Table D-1. Low Altitude Air
Defense Communications Networks.**

LAAD Communications Net	Purpose	Purpose
LAAD Team Control (VHF)	Used to communicate from team to section leader	AN/VRC-91 or AN/VRC-110
LAAD Weapons Control (HF)	Used to communicate from section leader to platoon commander	AN/PRC-150
LAAD Command (HF)	Used to communicate from platoons to the battery COC	AN/MRC-148 or AN/PRC-150
LAAD Battalion Command (HF)	Used to communicate from the firing batteries to the battalion COC	AN/MRC-148 or AN/PRC-150
Combat information (HF)	For reporting unidentified or hostile aircraft, initial contact, tracking, amplifying reports	Passed from TAOC
Direct air support (HF)	Provides a means for the DASC to request aircraft from the Marine TACC	Used by DASC to Marine TACC
Tactical air request/helicopter request (HF/VHF)	Provides a way for the LAAD section or ground units to request immediate close air support via the joint tactical air strike request report	AN/PRC-150 or AN/VRC-91

Lost or Degraded Communications

All LAAD personnel should be aware of the following alternate communications nets:

- Battalion or regimental tactical net (HF/VHF).
- Fire support coordination net (HF/VHF).
- Air operations control net (HF).
- Command action net (HF/VHF).

Note: See MCWP 3-40.3, *MAGTF Communications System*, for more information.

If a total loss of communications occurs, immediate action to re-establish communications must be taken by all affected units. Actions include an attempt to relay through collocated MACCS agency or supported unit, attempt to relay through adjacent LAAD elements, change location if tactical situation allows, and, if no contact is made within 30 minutes, send a runner to the most likely location that communications may be restored. It is the responsibility of the senior element to send the runner. If loss of communications occurs after a frequency change, return to the last frequency used. Until communications are restored, established ROE remain in effect during autonomous operations. Unless otherwise directed by operation orders or local combat SOP, LAAD units will comply with the following WCS rules.

If communications were lost and the WCS was—

- **Weapons tight.** Then units maintain weapons tight.
- **Weapons hold.** If a time limit was established, units maintain weapons hold, then revert to weapons tight. If no time limit was established, maintain weapons hold for 30 minutes and then revert to weapons tight.

- **Weapons free.** If a time limit was established, the same rule applies as in weapons hold. If no time limit was established, units immediately revert to weapons tight.

In the case of suspected or actual jamming, initiate the following actions: immediately submit a frequency interference report to higher headquarters and move stations closer together when tactically feasible, increase output power, shorten transmission bursts, relay through adjacent units, and use directional antennas. As a last resort, the senior element should direct all subordinate elements to change to an alternate frequency.

Communications Security

Always employ proper procedures to safeguard classified information, equipment, and operational details. Communications security is all measures designed to deny unauthorized persons information that might be derived from possession and study of communications. Communications security includes physical, cryptographic, and transmission security (TSEC). Maximum use of COMSEC capabilities and assets is paramount. In the interest of security, radio transmissions will be as short and concise as possible. Adherence to prescribed battalion or battery SOPs is mandatory. Unauthorized departure or variations from prescribed procedures often creates confusion, reduces reliability and speed, and tends to nullify security precautions. Cryptographic security, the use of cryptographic-systems, physical security, the safe guarding of classified equipment, documents, and materials are all part of COMSEC.

Authentication

Authentication is a security aid designed to protect communications against deception from fraudulent transmissions by unau-

MCRP 3-25.10A

thorized persons. Authentication is required whenever the identity of a station is in doubt. The Marine Corps is currently using the Triad Numerical Cipher/Authentication System. Use the memory aid READ (right encrypt authenticate down) to ease use of table D-2 on page D-8.

To identify the encipher/decipher line—

- Select three letters at random using table D-2. These three letters become the random set indicator.

Note: Do not repeatedly use the same three letters. Repeated use of the same three letters will degrade and jeopardize the security of the system.

- Go to the line indicated by the first letter of the random set indicator (far left single column of letters in bold print indicates lines).
- Read right on that line and locate the second letter of the random set indicator. Take the letter immediately to the right of that second letter and go to that line.

Note: If the letter you are directed to go to is the last letter in a line, go back to the first letter of the same line.

- Read right and locate the third letter of the random set indicator on the new line. Identify the letter to the right of that third letter. This letter will be the line indicator that identifies the encipher line. This line will be used to encipher or decipher any message.

EXAMPLE 1:

Use table D-2. The random set indicator is "CXF." The initial letter is "C," locate line "C."

Locate the second letter of the random set indicator "X" (within line "C"), identify the letter to the immediate right of "X." You should have identified the letter "P." Go to line "P," find the third letter "F" of the random set indicator. Identify the letter to the immediate right of "F." You should have identified the letter "P." Line "P" will be the encipher/decipher line.

To identify the encipher numbers—

- Read right and find the numbered column that corresponds to the first digit of the number(s) to be enciphered using the encipher line.
- Substitute one letter on that column for the plain text number.
- Stay on this line and repeat this process for each digit to be enciphered. Each column has from 2 to 4 letters listed for each number. These letters are called variants and should be chosen at random. Each variant from a column should be used before any letter is reused.

EXAMPLE 2:

Use table D-2. Encipher a six digit grid "142 497."

Go to encipher line, identified earlier as "P."

Read right to the numbered column that corresponds to the desired number. The first number of the six digit grid is "1." You should have found the corresponding letters for the number "1" on line "P" to have been "XUI."

Select a single letter to represent the number "1."

Repeat the above steps for subsequent numbers until all numbers are enciphered

Table D-2. Example of a Triad Numerical Cipher.

FOR OFFICIAL USE ONLY				UNCLASSIFIED						
				CIPHER						
	ABCD	EFG	HIJ	KLM	NO	PQR	ST	UV	WX	YZ
	0	1	2	3	4	5	6	7	8	9
A	AYGZ	MWC	IQN	KPU	BV	TJR	HE	LS	DO	XF
B	HIBY	ZGN	CQF	AOW	DV	TEX	ML	RJ	UK	PS
C	MJBF	IDA	WEX	POT	UQ	HRS	GZ	LK	CY	NV
D	BNDV	UGE	HTR	FJC	QI	ZLK	MY	AW	XP	OS
E	YAMG	SUF	KIR	PVB	JX	EZO	HN	LQ	WD	TC
F	ACNS	WHI	UMV	LFP	TJ	YOD	BX	KR	EZ	GQ
G	KNEZ	QYX	JOV	DLW	HP	SFM	BU	CR	TI	AG
	ABCD	EFG	HIJ	KLM	NO	PQR	ST	UV	WX	YZ
	0	1	2	3	4	5	6	7	8	9
H	HZNF	YBQ	PMT	UIC	DE	AVR	JG	XK	OL	SW
I	TCVK	FMZ	KXA	RWS	HO	UIP	QG	YN	DJ	EB
J	AFZG	MDL	YCE	NPO	JI	UKX	WQ	SV	HT	BR
K	SLUO	ZYM	JAP	IEP	QB	HVC	KW	GN	TD	XR
L	UTNM	RQO	BVA	YZH	SJ	FGC	KD	XI	WL	PE
M	GDPC	WTI	ZHS	XAV	KB	RQN	LM	FU	OJ	EY
	ABCD	EFG	HIJ	KLM	NO	PQR	ST	UV	WX	YZ
	0	1	2	3	4	5	6	7	8	9
N	SQXT	VRF	LNP	DGC	UK	BEJ	YO	MI	WA	HZ
O	QZER	SLY	PWG	JNI	UC	AKM	XO	BV	FD	TH
P	YODG	XUI	VLN	CFP	WE	HKN	AZ	RM	SB	QJ
Q	HRYD	AIX	SBP	UGL	OE	MCJ	ZQ	TV	KF	WN
R	HYDW	BKC	SUF	AXE	OT	PML	IR	GJ	QN	ZV
S	YQLX	MWZ	BAV	TKD	IG	FHC	SE	PJ	RU	NO

Table D-2. Example of a Triad Numerical Cipher. (Continued)

FOR OFFICIAL USE ONLY					UNCLASSIFIED					
					CIPHER					
	ABCD	EFG	HIJ	KLM	NO	PQR	ST	UV	WX	YZ
	0	1	2	3	4	5	6	7	8	9
T	GAZS	MVE	JPL	CKD	FY	HIO	BU	QT	XR	WN
U	HSPJ	CUT	NIQ	BLA	DX	EYO	FM	RK	ZV	GW
V	FKQB	VNO	JRI	SPH	CL	MWX	AY	GT	EZ	UD
W	WFZS	PBL	YNG	DIH	CQ	VMX	KE	JR	TU	AO
X	WPXQ	CBF	RGV	YOT	NM	JUH	EK	IL	DS	ZA
Y	FSKD	LRX	CGN	HAJ	EI	MZO	WP	VB	QU	YT
Z	PHCR	NQS	AYI	FDW	ZB	EGJ	VM	LT	KU	OX
	Day 01-02									

Transmit

When using this system, plain text can be mixed with cipher text. The words “I SET” must precede the enciphered message. This indicates that the next three letters will be the random set indicator. Pause your communications transmission, and then continue to indicate a space between the set indicator and enciphered numbers.

Decipher Numbers

After receiving the enciphered message, identify the random set indicator. This will be the first three letters of the cipher text message following the words “I SET.” Determine the appropriate decipher line using the previously discussed procedures. Using

this decipher line, read right on the line to locate the first letter of the cipher text. Determine which number appears at the top of that column. Substitute that column number for the cipher text letter. This number is the first digit of the plain text message. Remain on that line and repeat this process for each letter of cipher text.

Authenticate

The Triad system provides two methods of authentication: the challenge-and-reply authentication and the transmission authentication. The challenge-and-reply method is the primary means of authentication for LAAD gunners. Challenge-and-reply authentication should be used whenever possible to verify a station's authenticity. The called party will always make the first challenge. The party calling may counter challenge after the initial exchange to verify authenticity. This procedure is usually carried out when the calling party suspects a bogus station is impersonating another station.

Challenge

Select three letters at random. Random selection is essential for security reasons. Do not repeat challenges and do not use standard groups such as "ABC," "AAA," etc. Verify the correct response prior to receiving an answer from a calling station.

Reply

Using the three letters transmitted in the challenge, take the first letter and go to the line indicated by that letter. The far left single

column of letters in bold print indicates lines. Move to the right on that line until the second letter of the challenge is located. Take the letter directly below the second letter of the challenge and go to the line indicated by that letter. Move to the right on that line until the third letter of the challenge is located. Take the letter directly below the third letter of the challenge. This is the reply letter.

Note: If directed to go to a letter below the ZULU line for authentication purposes, choose letter from the same column on line Alpha.

EXAMPLE 1:

Use table D-2 on page D-8 to authenticate "RLG."

Go to line "R," locate the second letter of the challenge "L," identify the letter directly below "L." You should have found the letter "C."

Go to line "C," locate the third letter of the challenge "G," identify the letter directly below "G." The authentication reply is "M."

Destroying Communications Equipment

Burning

Within a general area, equipment is stacked in small piles and an incendiary grenade is placed in the center of each pile. The pins are pulled remotely or small arms are used to fire at the grenades. If that procedure is not possible, all the equipment is placed in a pile with minimal separation between items. The pile is doused with flammable liquid and ignited with an incendiary grenade or a flare.

Removal and Destruction of Components

If time does not allow for complete destruction of the communications equipment, the equipment is disassembled and removed and components destroyed or scattered. Crystals, modules, tubes, and switches are removed and an axe or sledgehammer is used to render them inoperative and indistinguishable. If a heavy vehicle such as a tank or a large truck is available, the components can be placed in its path and driven over repeatedly.

Small Arms Fire

This is the least desirable way to destroy equipment as the chance remains that the equipment could still be used with components from another set. If this method of destruction is selected, the equipment is placed such that the most exposed area is facing the designated firing team. The team is allowed to fire as many rounds as possible into each piece of equipment to ensure it is destroyed. This is accomplished by firing about 3 inches in from each corner of the equipment, as well as directly into the center of the gear.

Submerging

The equipment's retaining screws are loosened and the seals are cracked. The equipment is thrown overboard or into any nearby body of water.

Field Expedient Antennas

Any radio system's capabilities are limited by the design of the system. The radio will only transmit a specified amount of power, but power alone is not necessarily the answer to establishing or maintaining a radio circuit. Operator training, equipment maintenance, and employing the radio system to maximize its capabilities and minimize factors that negatively impact the

radio's circuits determine success. The key to obtaining optimum performance from the system is to understand the basics of how they work and how to improve them. The construction of an appropriate field expedient antenna is a necessary skill for mission accomplishment. Antennas can be constructed from any electrically conductive material (i.e., slash wire, barbed wire, metal pipe, rain gutter). Although any conductive material can be used, multi-strand copper wire of 18 gauge or better provides the best performance. The key to constructing an effective field expedient antenna is the proper usage of antenna wavelength formulas and the selection and construction of the appropriate antenna to accomplish the job. Antenna selection is accomplished by considering what will affect the circuit or net, what negative effects can be minimized, and what positive characteristics can be used to enhance the circuit or net. Minimum considerations for selecting an antenna are—

- What directional characteristics are required?
- What, if any, obstructions are in the path to distant stations?
- Will the distant station be mobile?
- What is the transmit distance between stations?
- Are the materials required to build the antenna available?

All antennas have radiation patterns. Antenna directivity is classified according to how they radiate energy in the horizontal plane. The three classifications are—

- Omni-directional antennas radiate energy equally in all directions of the compass.
- Bi-directional antennas radiate energy in two main lobes in opposite directions.
- Uni-directional antennas radiate energy primarily in one direction.

Very High Frequency

For Marine Corps purposes (30 to 87.975 MHz), VHF communications provide the primary means for ground-to-ground, short-range communications used by tactical units. The VHF frequencies are not usable for sky-wave propagation, but do provide some surface wave and is usable for ground-wave communications. The VHF communications provide circuits free from fading.

High Frequency

For Marine Corps purposes (2 to 29.999 MHz), HF communications provide sky-wave propagation in the lower portion of the band. The HF also propagates in ground-wave. A disadvantage of HF communications is high levels of interference. The HF spectrum is congested due to the large number of HF radio equipment currently in use and the long-range propagation of each HF frequency in use.

Antenna Wavelength Formulas

Radio waves in free space travel at the speed of light. When RF energy is applied to an antenna, it travels through the material of the antenna and its speed changes. The following formulas are used to compute the optimal length of expedient antenna wires:

- Formula for a quarter wavelength is 34 divided by the frequency in MHz = 1/4 the wavelength in feet. For example:
 - 1/4 wavelength for 3 MHz is 34 divided by 3 = 11.33 ft (wire length)
 - 1/4 wavelength for 30 MHz is 34 divided by 30 = 1.13 ft (wire length)

- Formula for a half wavelength is 468 divided by the frequency in MHz = 1/2 the wavelength in feet. For example:
 - 1/2 wavelength for 3 MHz is 468 divided by 3 = 156 ft (wire length)
 - 1/2 wavelength for 30 MHz is 468 divided by 30 = 15.6 ft (wire length)
- Formula for a full wavelength is 936 divided by the frequency in MHz = 1 wavelength in feet. For example:
 - 1 wavelength for 3 MHz is 936 divided by 3 = 312 ft (wire length)
 - 1 wavelength for 30 MHz is 936 divided by 30 = 31.2 ft (wire length)

Horizontal/Vertical/Inverted V or Drooping Dipole

The horizontal dipole can be used for HF or VHF, but it is important to note the ground effects on the radiation pattern. The dimensions for the horizontal and vertical dipole are the same. The antenna consists of two independent, quarter wavelength wires placed in line and end to end. The two near ends are as close as possible, but insulated from each other. Each of the independent wires is connected to different sides of the coax cable (i.e., one is connected to the center conductor and the other is connected to the braided ground conductor). The transmission line should be kept perpendicular to the antenna to the maximum extent possible. The vertical dipole does not use the ground as an image antenna, which is possible with a quarter-wave or whip antenna using ground radials. Therefore, raising the antenna as high as

MCRP 3-25.10A

possible will provide the best performance and increases the range of the system. The bottom of the antenna should be secured to the ground to keep the antenna orientated vertically. When the antenna is supported from a tree, tower, or metal mast, the antenna should be extended out from the support as far as possible and in the direction that maximum radiation is desired (see figs. D-2 and D-3).

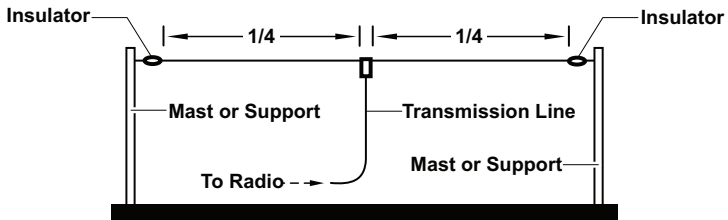

Figure D-2. Horizontal Dipole.

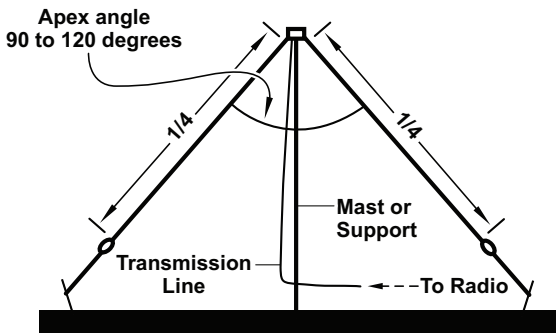
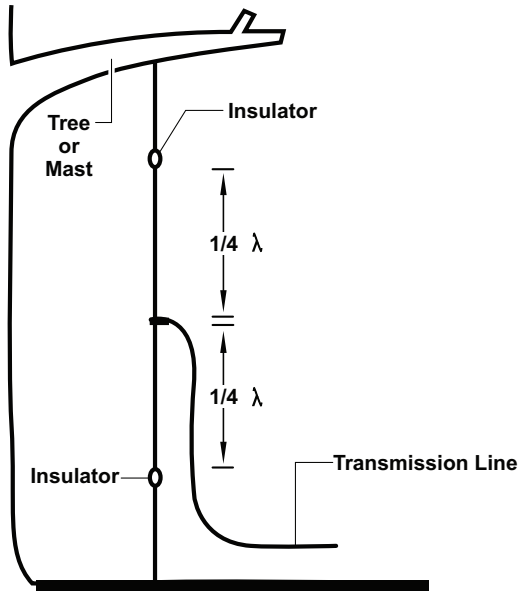

Figure D-3. Vertical Dipole and Inverted V or Drooping Dipole.

Sloping V

A sloping V antenna is essentially two sloping long wire antennas orientated so that the energy radiated from each leg reinforces the other. If terminating resistors are not used, the antenna is considered bi-directional. However, the required takeoff angles may not be achieved in order to communicate effectively in both directions. This antenna is considered an effective antenna for both HF and VHF communications (see fig. D-4).

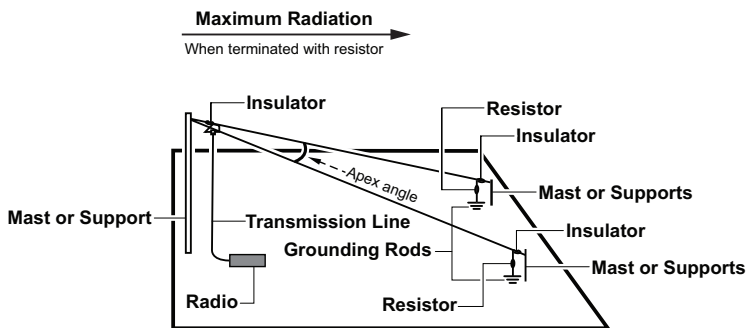

Figure D-4. Sloping V.

Vertical Half Rhombic

Vertical half rhombic antennas are high gain antennas and can enhance most communications circuits. Rhombic antennas are long wire antennas, rather large in size. They can easily be used for VHF or HF circuits that require a low takeoff angle. Rhombic antennas are characteristically bi-directional or uni-directional if terminating resistors are used. The vertical half rhombic is constructed from one piece of antenna wire, which is supported in the middle by a single mast (see fig. D-5).

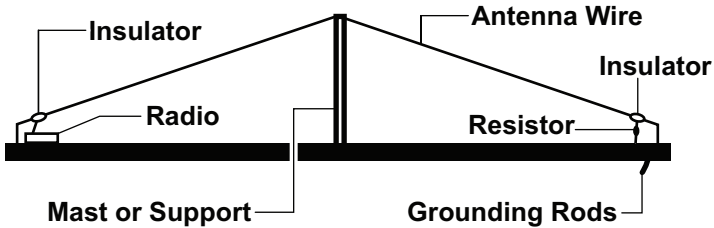

Figure D-5. Vertical Half Rhombic.

Inverted L

The inverted L antenna provides omni-directional, vertically polarized, ground-wave signal from the vertical section and a high takeoff angle, horizontally polarized signal off of the horizontal portion. The inverted L radiation pattern is dependent on the length of the vertical portion compared to the horizontal portion (see fig. D-6). The entire antenna is one piece. The longer portion (vertical or horizontal) will radiate more energy than the shorter portion (vertical or horizontal). Both the vertical and horizontal portions of the inverted L are constructed from one piece of wire that is $3/4$ wavelength in size. The radiation pattern is dependent on how much of the $3/4$ wavelength wire is positioned vertically rather than horizontally. The insulator at the vertical and horizontal joint only insulates the antenna wire from the support mast. The wire is connected to the center conductor of the radio's antenna connector or secured underneath a component antenna base. A counter poise can be created to enhance the radiation from the horizontal element but is not required.

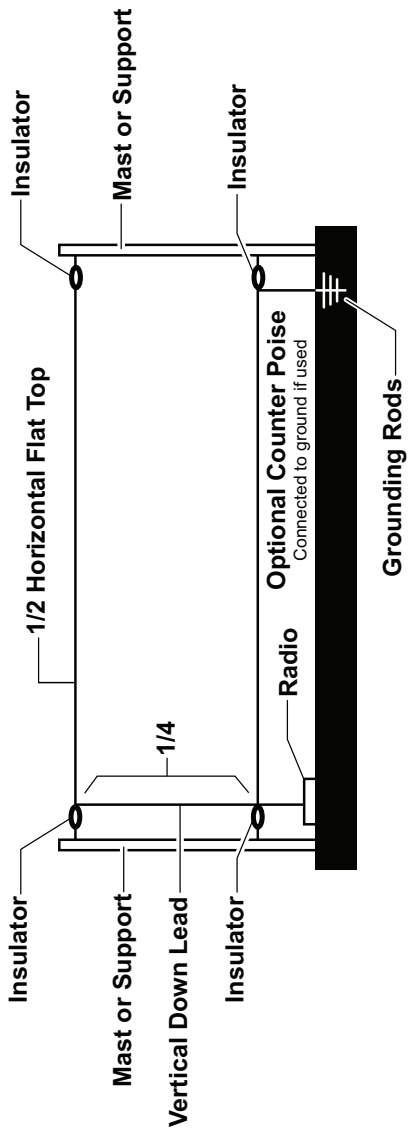

Figure D-6. Inverted L.

Appendix E

Stinger Support Equipment

Gas Pumping Unit

The GPU is the largest and most effective of the THT fill units (see fig. E-1). The GPU is comprised of an electrically-driven compressor, in-line desiccant filters, relief valve, two pressure switches, and various control valves. The GPU is basically a combined gas cleaning and pumping unit used to fill the internal trainer argon gas bottle up to 6000 ± 200 lbs-force psig within a maximum period of 45 minutes. A 6000 psi in-line pressure switch automatically shuts off the pump when the outlet pressure gage reaches between 5800 and 6200 psig. The relief

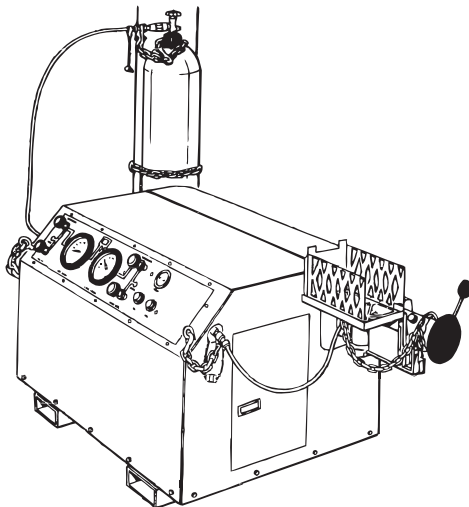

Figure E-1. Gas Pumping Unit.

valve functions as a secondary safety valve by immediately releasing high pressure in the event the pressure switch fails. Detailed GPU operation is explained in TM 9-6920-430-14, *Operator's and Organizational Direct Support, and General Support Maintenance Manual Coolant Recharging Unit, Training Guided Missile System M80 6920-01-024-9970 Charger, Battery PP-7309/T 6130-01-024-6922.*

***CAUTION:** Extreme caution and proper utilization of the appropriate steps is imperative when operating this unit as it uses argon gas, which is a colorless, odorless, inert gas that displaces oxygen in high concentrations and can cause dizziness and suffocation. Always use TM 9-6920-430-14, when operating this system.*

Battery Charging Unit

The battery charger charges up to 5 nickel cadmium batteries housed in a carrying case for use during field training operations (see fig. E-2). The charger operates from 115 VAC, 50/400 Hz,

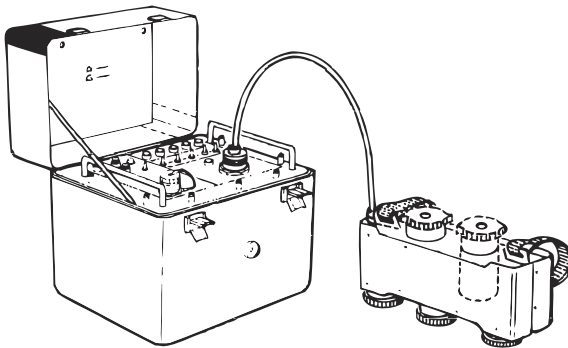

Figure E-2. Battery Charging Unit.

and single-phase power. It charges 1 to 5 batteries independently or simultaneously within a maximum of 16 hours. The battery charger contains charging, charge test, and power input circuits. The charger also supplies heater power to the carrying case. A heater control circuit within the carrying case thermostatically controls the battery compartment temperature in order to obtain optimum charging in low temperature environments. Detailed battery charger operation is explained in TM 9-6920-430-14.

Appendix F

Identification, Friend or Foe Equipment

Battery Charging

The IFF belt pack batteries are charged using the AN/GSX-1A programmer/battery charger. A minimum of 4 hours is needed to fully charge the batteries. Up to six batteries can be charged simultaneously. Six cable connectors are routed through the inside center bracket of the battery compartment. Each cable connector has an identification number that corresponds to the number alongside each of the six TEST/OFF/CHARGE switches. The brightness of each indicator lamp on the programmer may be adjusted by turning the lens assembly. The battery compartment door remains open during the entire charging period unless ambient temperature or battery temperature is below freezing. If all battery charging indicators go out at once, the battery compartment's maximum temperature has been exceeded and the compartment will have to cool before charging will resume.

Battery Installation

Install a freshly charged battery in the interrogator before programming it (see fig. F-1 on page F-2):

Step 1: Open battery compartment lid. Insert the batteries to be charged into battery receptacles.

Step 2: Insert the cable connector in the battery charging receptacle.

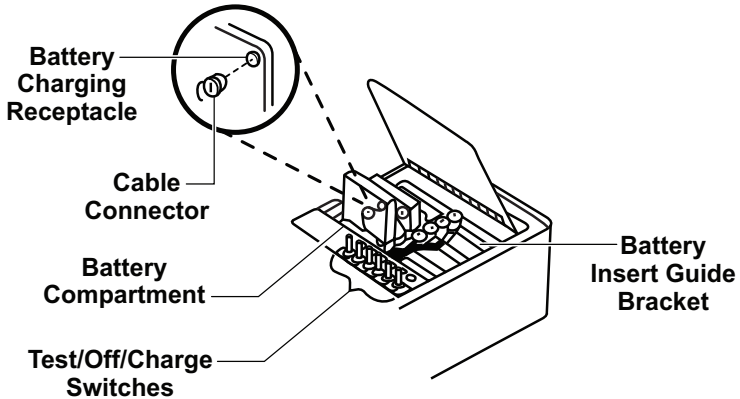

**Figure F-1. Identification,
Friend or Foe Battery Charging.**

Step 3: Set the POWER switch to OFF. Connect the power cable W2 to 115V 1 PH 50-400 Hz POWER CONNECTOR. Connect the power cable to the power source.

Step 4: Set the six TEST/OFF/CHARGE switches to OFF (center) positions.

Step 5: Set the POWER switch to ON. The POWER DC lamp should illuminate. If the POWER DC lamp does not illuminate, press and hold the lens assembly to check if the indicator is operating.

Step 6: Set the appropriate TEST/OFF/CHARGE switches corresponding to the batteries to charge. Observe that appropriate lamp lights. If a lamp does not light, be sure that the appropriate battery is properly connected.

Step 7: Let the batteries charge for about 10 minutes. One at a time, hold appropriate TEST/OFF/CHARGE switches to the TEST position. For each TEST position, the BATTERY TEST lamp will light, if the battery is not defective.

Step 8: Reset the appropriate TEST/OFF/CHARGE switches to CHARGE.

Step 9: After 4 hours, set the appropriate TEST/OFF/CHARGE switches to OFF. Disconnect the charging cable from the battery. Remove the charged batteries from their receptacles.

Battery Conditioning

The test function is designed for one battery at a time. Testing or cold weather conditioning more than one battery at a time can damage the test-charge load resistor. Battery cold weather conditioning is required when the IFF interrogator is used in temperatures below 0 °F. To condition a battery for temperatures below -25 °F and above -40 °F, the battery must be discharged approximately 10 percent after being fully charged. The discharge is accomplished by holding the BATTERY TEST switch in the TEST position for about 1 minute. If the operating temperature is

expected to be below -40 °F, the discharge time is doubled to about 2 minutes. Dual control and indicator circuitry permits charging of the IFF batteries while programming the IFF interrogator.

Background

After a charged battery is installed, the IFF interrogator is manually programmed for 4 days of operation. The appropriate fill device is used to insert the proper Mode IV codes into the computer (Mode III codes are built into the interrogator). The programmer extracts the Mode IV codes from the computer and inserts them into the interrogator.

One of two programs is selected by operating a function switch on the programmer. For either program, the programmer initiates an automatically, timed 4-day countdown period in the interrogator. After 4 days, the interrogator switches to and continues in Mode III operation until the batteries are discharged or the interrogator is reprogrammed.

In the Mode IV/III position (the normal setting used for programming), the interrogator is programmed to interrogate in Modes IV and III. Initial interrogation is made in Mode IV. If there is no Mode IV reply by the aircraft or the reply is incorrect, the interrogator automatically switches to Mode III and interrogates again. In Mode IV, the interrogator is programmed to interrogate in Mode IV only. The interrogator will not automatically interrogate in Mode III after an incorrect Mode IV reply. Certain situations may require that the interrogator be programmed for Mode IV only operation.

The interrogators can be programmed every 2 to 3 days at section headquarters or at each team's location. Each team can exchange its interrogator for one that is programmed. The section leader is

ultimately responsible for ensuring that each team's belt packs are reprogrammed before the Mode IV codes expire. The programmer performs a self-check of the interrogator after data transfer.

An audio signal confirms that the interrogator is operational, but the audio signal does not confirm the interrogator is properly programmed. The interrogator's Mode IV codes are tested and verified with a known friendly aircraft (with operational and correctly coded Mode IV transponder). The battery attached to the side of the IFF interrogator must be replaced with a charged battery before programming.

Note: Prior to attempting to program, ensure all equipment has the appropriate batteries installed. The KIR-1C requires two BA5567 batteries for memory storage capability. The AN/CYZ-10 requires three, 3-volt lithium batteries (BR-2/3 ASSP) or one DL123A for operation. The SKL utilizes rechargeable lithium batteries for operations.

The AN/PPX-3 B/A accepts and stores Mode IV codes for up to 4 days. Each key tape is broken down into two segments, A and B. Segment A represents the IFF program for the actual date drawn, while segment B represents the following day. The KIR 1-C is capable of holding a single key tape of segments A and B. Both segments are required for the KIR 1-C to accept and distinguish the Mode IV alarm lamp on the AN/GSX 1-A. Loading more than one key tape will overwrite previous IFF code, making the program invalid. Each AKAT canister consists of 34 consecutive key tapes. As previously stated, each key tape is further broken down into two segments, A and B, for a total of 68 individual tapes. The first 27 key tapes are numbered sequentially 1 through 27; the remaining key tapes are numbered F28, 28, F29, 29, F30, 30, and 31. The F-series key tapes are used to program the final day of the month.

MCRP 3-25.10A

For example, there are 30 days in the month of November. When programming the last day of the month, the section leader will use the tape segment marked F30 vice using the tape segment marked 30. The F designates a key tape as a final day of the month IFF fill. The F-series key tapes are used for months that end on the 28th, 29th, and 30th. When programming 4 days of Mode IV code into the AN/PPX-3 B/ A, key tape 1 is used for days 1 and 2 and key tape 2 of the AKAT tape is skipped. Key tape 3 is used for days 3 and 4 four. Key tape 1 is representative of the first day of Mode IV code desired to be programmed regardless of the date.

Another example is if the section leader desires to program Mode IV IFF from the 19th of March to the 22nd of March (4 days), he/she will draw AKAT key tape for the 19th (key tape 1) for the required days 1 and 2 (19th and 20th) of Mode IV code, then skip the 20 March key tape (key tape 2). The section leader will then use the 21 March key tape (key tape 3) for days 3 and 4 (21st and 22d), which will provide 4 days of Mode IV code (see fig. F-2).

Figure F-2. AKAT Mode 4 Key Tape.

Key tape 1		Key tape 2	
19 Mar		20 Mar	

Seg A (1)	Seg B (2)	Seg A (2)	Seg B (3)
Day1 Day 2		Day 2 Day 3	

Connecting Equipment

Connect IFF equipment using the following steps (see fig. F-3 as a diagram of equipment connections):

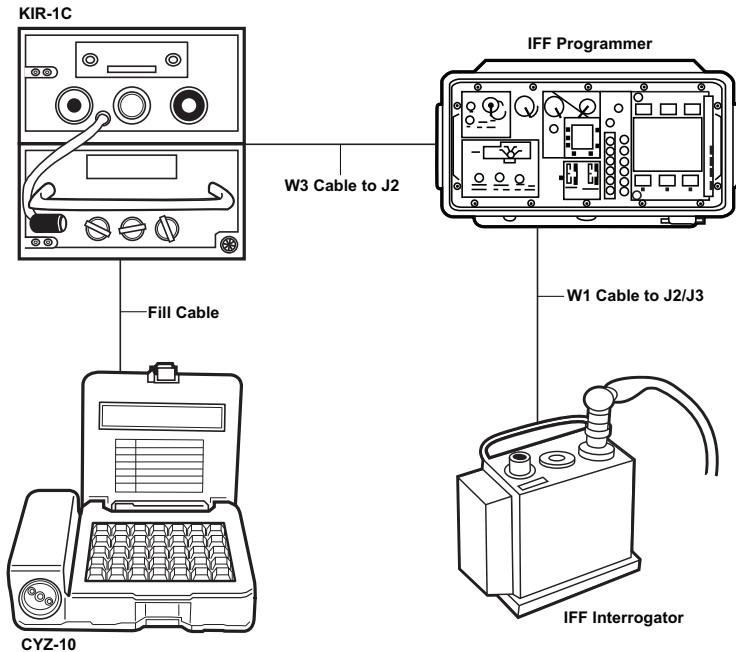

Figure F-3. Programming Identification, Friend or Foe Equipment.

Step 1: Press the pressure equalizer valve in programmer cover, on the IFF programmer, and then remove cover. Set the POWER switch to OFF. Connect power cable W2 to 115V 1 PH 50-400 Hz

MCRP 3-25.10A

power connector J1 on programmer. Connect other end of the power cable to the power source.

Step 2: Connect computer cable W3 from TSEC/KIR-1C to connector J2, on programmer, on the IFF programmer. If the dust cover is installed on computer connector, remove the dust cover by loosening the two screws holding it in place. Attach other end of cable W3 to the rear of the KIR-1C computer.

Step 3: Connect program cable W1 to interrogator program connector J3, on the IFF programmer. Connect the other end of W1 to J2 connector on the IFF interrogator.

Step 4: Connect IFF interrogator interconnecting cable to interrogator test connector J4 on programmer.

Step 5: Set the POWER ON/OFF switch on programmer to ON, on the IFF programmer. The POWER DC and MODE IV ALARM lamps will light. Press to test each lamp on programmer before operation. The MODE IV ALARM lamp remains lighted until the code is entered into the computer. The brightness of each indicator lamp on the programmer may be adjusted by turning the lens assembly.

Loading TSEC/KIR-1C Utilizing the AN/CYZ-10 DTD

To load the TSEC/KIR-C1 by utilizing the AN/CYZ-10 DTD, perform the following steps:

Step 1: Turn on AN/CYZ-10 by pressing the ON/OFF button on the keypad. If DTD does not default to main menu, manually select the MAIN MENU from DTD keypad.

Step 2: Select APPLICATION. Press ENTER.

Step 3: Select RADIO. Press ENTER.

Step 4: Select COMSEC. Press ENTER.

Step 5: Select LOAD. Press ENTER.

Step 6: Select TRAFFIC ENCRYPTION key. Press ENTER.

Step 7: Scroll to desired key fill. Press ENTER. The key fill is identified by the label the user assigned to each fill at step 10 when loading the AN/CYZ-10 with IFF cryptographic.

Step 8: Select QUIT. Press ENTER.

Step 9: Press the down arrow on AN/CYZ-10 keypad until the menu displays PRESS LOAD ON R/T message.

Step 10: Connect the fill cable between the AN/CYZ-10 and the TSEC/KIR-1C. Press ENTER.

Step 11: Disconnect the fill cable from the TSEC/KIR 1-C.

Step 12: Repeat steps 2 through 11 to load segment B of the required IFF fill.

Note: The TSEC/KIR-1C is only capable of holding two days IFF fill at a time (two days IFF is defined as a single key tape of both segments A and B). When programming the belt packs, program days 1 and 2. Zeroize the IFF code from the TSEC/KIR-1C, then fill the TSEC/KIR-1C with days 3 and 4 of IFF code to be loaded into the belt packs.

Step 13: Upon acceptance of segment B, the TSEC/KIR-1C green indicator light will briefly flash again. The MODE IV ALARM lamp on the AN/GSX 1-A will extinguish, indicating the Mode

MCRP 3-25.10A

IV IFF code has been accepted. Program AN/PPX-3 B/A belt packs in accordance with the previously identified procedures.

Note: For further information on loading the TSEC/KIR 1-C computer, see TM 10254A-10/1, *AN/CYZ-10(V)3 Data Transfer Device Operator's Manual PMW161-DTD-OM-1*.

Programming IFF Utilizing the AN/CYZ-10 DTD

To program the IFF utilizing the AN/CYZ-10 DTD, perform the following steps:

Step 1: Connect the W2 fill cable to AN/CYZ-10 DTD. Connect the fill cable from AN/CYZ-10 DTD to the faceplate of TSEC/KIR-1C.

Step 2: Connect W3 cable from the AN/GSX-1A battery charger/programmer to the TSEC/KIR-1C.

Step 3: Refer to the current electronic key material system callout sheet for appropriate AKAT tape segment. Pull the required day segment. The segment will include an A and a B portion. Both are required to program one day of IFF.

Step 4: Load the fill into TSEC/KIR-1C from DTD.

Step 5: Disconnect the fill cable from the TSEC/KIR-1C briefly, reconnect, and then load portion B of the required day segment. If the fill cable is not disconnected briefly, the computer will treat segment A and segment B as one large segment.

Note: If the TSEC/KIR-1C accepts the codes, the green light display on the faceplate of the TSEC/KIR-1C will flash briefly. The light will only blink after both the A and B segments have been accepted into the computer. The Mode IV alarm lamp on the AN/GSX-1A will go out.

Step 6: Disconnect the fill cable from the TSEC/KIR-1C. If the lamp remains lighted, check all the cable connections, zeroize the KIR-1C, and then repeat steps 4 through 13.

Step 7: Set CODE ENTRY SELECT switch to desired select M4/M3 or M4 position.

Step 8: Set the TIME ENTRY HOURS and MINUTES pushbutton switches to enter ZULU time.

Step 9: Enter ZULU time into TIME ENTRY switches, then push forward and hold the ENTER CODE TIME switch until CODE/TIME ACCEPTED lamp lights. This updates automatic 4-day clock in IFF interrogator.

Step 10: Set the CODE ENTRY SELECT switch to DAY 1.

Step 11: Push forward and hold the ENTER CODE/TIME switch until CODE/TIME ACCEPTED lamp lights.

Step 12: Set the CODE ENTRY SELECT switch to DAY 2.

Step 13: Push forward and hold the ENTER CODE/TIME switch until CODE/TIME ACCEPTED lamp lights.

MCRP 3-25.10A

Notes: If programming additional IFF interrogators with day 3 and 4, perform steps 14 through 24.

POWER switch must remain ON while disconnecting program cable if TSEC/KIR-1C does not have memory batteries installed.

Step 14: Disconnect the IFF interrogator by disconnecting program cable W1 at the J12 connector on interrogator. Disconnect the cable at the interrogator test connector J4 on the programmer.

Step 15: Push ZEROIZE button on face plate of TSEC/KIR-1C. When MODE IV ALARM lamp is on AN/GSX-1A will light, which confirms days 1 and 2 of IFF program have been successfully purged from TSEC/KIR-1C.

Step 16: Load days 3 and 4 segments of AKAT from AN/CYZ-10 DTD to TSEC/KIR-1C.

Note: If the TSEC/KIR-1C accepts the codes, the green light display on the faceplate of the TSEC/KIR-1C will flash briefly. The light will only blink after both the A and B portions of the AKAT segment have been accepted into the computer. The MODE IV ALARM lamp on the AN/GSX-1A will go out.

Step 17: Disconnect fill cable from the TSEC/KIR-1C. If the lamp remains lighted, check all cable connections, and repeat steps 16 through 24.

Step 18: Set the CODE ENTRY SELECT switch to the desired select M4/M3 or M4 position.

Step 19: Set the CODE ENTRY switch to day 3.

Step 20: Push forward and hold the ENTER CODE/TIME switch until CODE/TIME ACCEPTED lamp lights. Day 3 of IFF program has been successfully programmed.

Step 21: Set CODE ENTRY SELECT switch to DAY 4.

Step 22: Push forward and hold the ENTER CODE/TIME switch until CODE/TIME ACCEPTED lamp lights. Day 4 of IFF program has been successfully programmed.

Step 23: Push forward and hold the INTERROGATOR TEST switch until the test tone is heard from the speaker, indicating IFF interrogator operational. If there is no tone, check the cable connections and battery, zeroize belt pack, and repeat steps 1 through 23. If still no tone, the IFF interrogator belt back is nonfunctional.

Note: POWER switch must remain ON while disconnecting program cable if TSEC/KIR-1C does not have memory batteries installed.

Programming IFF Utilizing the AN/PYQ-10 SKL

Initial SKL power up/log on procedures are as follows:

Step 1: Press and hold the POWER pushbutton for approximately 3 seconds or until you see the system start to boot and then release the push button. The POWER pushbutton is located at the front upper right-hand corner of the SKL. The system should boot to the window.

Step 2: Observe the KOV-21 light emitting diode to make sure it is not flashing. If it is flashing, a LOG ON window has opened indicating that you must log on to the core library to proceed.

MCRP 3-25.10A

Step 3: Enter the correct **USERNAME** and **PASSWORD**.

Step 4: Tap **OK**. This window displays the **SKL** version and date, **SKL** database version, the highest signal operating instructions classification, and the highest key classification. The amount of free audit space is broken down into four different categories: total bytes free, total bytes used, percentage of bytes free, and percentage of bytes used.

Note: Pay particular attention to the amount of audit bytes used as this will become an important number to know as explained later in this work package. Tap on the **OK** button with the stylus. The **SKL UAS** main menu is displayed. The **SKL UAS** main menu has now been opened and is ready for use.

Step 5: Enter the **SKL UAS** menu, allowing access to the designated equipment and load sets needed to fill the **IFF** subsystem.

Step 6: Tap on the **EQUIP TAB** once the **SKL UAS** menu opens. If the **SKL** does not have a **KIR-1C**, go to **FILE** then **ADD EQUIPMENT**. Name the equipment (i.e. **IFF**, **KIR-1C**, or **AN/PPX-3B**); the equipment type will be **KIR-1C** then tap **OK**.

Step 7: Assign the correct key tag to that piece of equipment, go to **FILE** then **ASSIGN**, and **SELECT KEY TAG** the **ASSIGN KEY TAG** box will open, select **AKAT** and tap **NEXT**. The location box will ask which location you want to place the **AKAT** in, select **LOC 2** (by doing this, it will place odd dated segments in **LOC 1** and even dated segments in **LOC 2**).

Step 8: Begin to fill the **KIR-1C** with the correct dated segments from the **AKAT** once key tags are assigned to the equipment. Connect the fill cable to the **KIR-1C**.

Step 9: Locate the dated segment to be loaded ensure it is segment A first (i.e. 5A or 5B), highlight it, go to LOAD in the upper right corner and tap it. The LOAD ECU WIZARD will open. If all information is correct, tap NEXT and follow instructions provided by SKL. Once the first segment is loaded, the SKL will ask if you want to reload equipment, select NO.

Step 10: Disconnect fill cable from the KIR-1C momentarily, reconnect, and repeat the processes using segment B of the current day's segment. Once complete, MODE IV ALARM lamp should go out and the green light on the KIR-1C flashes.

Step 11: Set the CODE ENTRY SELECT switch to desired SELECT M4/M3 or M4 position.

Step 12: Set the TIME ENTRY HOURS and MINUTES, pushbutton switches to enter ZULU time.

Step 13: Enter ZULU time into TIME ENTRY switches, then push forward and hold the ENTER CODE TIME switch until CODE/TIME ACCEPTED lamp lights. This updates automatic 4-day clock in IFF interrogator.

Step 14: Set the CODE ENTRY SELECT switch to DAY 1.

Step 15: Push forward and hold the ENTER CODE/TIME switch until the CODE/TIME ACCEPTED lamp lights.

Step 16: Set CODE ENTRY SELECT switch to DAY 2.

Step 17: Push forward and hold the ENTER CODE/TIME switch until the CODE/TIME ACCEPTED lamp lights.

Note: If programming additional IFF interrogators with day 3 and 4 continue with steps 18-27.

MCRP 3-25.10A

Step 18: Disconnect the IFF interrogator by disconnecting program cable W1 at the J12 connector on interrogator. Disconnect the cable at the interrogator test connector J4 on the programmer.

Step 19: Push the ZEROIZE button on the face plate of TSEC/KIR-1C. The MODE IV ALARM lamp on the AN/GSX-1A will light, which confirms that days 1 and 2 of IFF program have been successfully purged from TSEC/KIR-1C.

Step 20: Load days 3 and 4 segments of AKAT from the AN/PYQ-10 SKL to the TSEC/KIR-1C.

Note: If the TSEC/KIR-1C accepts the codes, the green light display on the faceplate of the TSEC/KIR-1C will flash briefly. The light will only blink after both the A and B portions of the AKAT segment have been accepted into the computer. The MODE IV ALARM lamp on the AN/GSX-1A will go out.

Step 21: Disconnect the fill cable from the TSEC/KIR-1C. If the lamp remains lighted, check all the cable connections, and then repeat steps 18 through 27.

Step 22: Set the CODE ENTRY SELECT switch to the desired SELECT M4/M3 or M4 position.

Step 23: Set the CODE ENTRY SELECT switch to DAY 3.

Step 24: Push forward and hold the ENTER CODE/TIME switch until CODE/TIME ACCEPTED lamp lights. Day 3 of IFF program has been successfully programmed.

Step 25: Set CODE ENTRY SELECT switch to DAY 4.

Step 26: Push forward and hold the ENTER CODE/TIME switch until the CODE/TIME ACCEPTED lamp lights. Day 4 of IFF program has been successfully programmed.

Step 27: Push forward and hold INTERROGATOR TIME switch until test tone is heard from speaker, indicating IFF interrogator operational. If there is no tone, check cable connections and battery, zeroize belt pack, and repeat steps 1 through 27. If still no tone, IFF interrogator belt back is nonfunctional.

Note: POWER switch must remain ON while disconnecting program cable if TSEC/KIR-1C does not have memory batteries installed.

Appendix G

Remote Terminal Unit

Remote Terminal Unit Setup

To set up the RTU, perform the following steps. Refer to TM 10296A-10/1-1, for more detailed information.

Step 1: Turn RTU on by pressing ON/OFF key. It will take the system a few seconds to initialize.

Step 2: Select EADS [Expeditionary Air Defense System] by pressing the appropriate number when the selection menu appears. SELECT A PROGRAM will appear.

Step 3: Select EADS TACTICAL, by pressing the appropriate number (the system will take approximately 1 minute to boot). The EADS SYSTEM CONFIGURATION menu will appear.

Step 4: Select the appropriate item for the use of the RTU under MAJOR ITEMS. For the A-MANPADS team, type M0 to select NONE.

Step 5: Type R1 under RADIO submenu to select SINGGARAS RADIO and then select RECEIVE. If a data link must be forwarded from current position select TRANSMIT AND RECEIVE.

Step 6: Type P1 automatic position to select PLGR. If not using the PLGR, leave blank.

Step 7: Enter station address by pressing the F1 key, type the RTU address, and press ENTER.

MCRP 3-25.10A

Step 8: Enter team call sign by pressing the **F2** key, type call sign, and press **ENTER**.

Step 9: Enter local time by pressing the **F3** key, type in local time, and press **ENTER**.

Step 10: Enter date by pressing **F4** key, type date (e.g., 07-19-00), and press **ENTER**.

Step 11: Press **ENTER** to launch application, and then the **MAIN SCREEN** will appear.

Input Emplacement Data

To input emplacement data perform the following:

Step 1: Press the **SHIFT** key and **EMPLACEMENT DATA (F12)** key. The **OPTIONS** menu will appear.

Step 2: Select **UNITS OF MEASURE**. Press **ENTER**.

Step 3: Select **DEGREES** when **AZIMUTH** is highlighted, using left or right arrows to scroll through **OPTIONS**. Press **ENTER**. **RANGE** will now be highlighted.

Step 4: Select **NAUTICAL MILES** or **KILOMETERS**. Press **ENTER**. **VELOCITY** is now highlighted.

Step 5: Select **KNOTS** or **METERS PER SECOND**. Press **ENTER**. **ALTITUDE** is now highlighted.

Step 6: Select **FEET** or **METERS** as desired. Press **ENTER**.

Step 7: Select the altitude reference as **ABOVE GROUND LEVEL** for team configuration setup. Press **ENTER**.

Step 8: Select **COORDINATE SYSTEM, MGRS**. Press **ENTER**.

Step 9: Enter **ZULU** time configuration. Press **ENTER** twice.

Step 10: Select **SECTORS/ALERTS** when **OPTIONS** menu appears, using up/down arrow keys. Press **ENTER**. **START DEGREE** will be highlighted.

Step 11: Enter start degree as 0. Press **ENTER**. **STOP DEGREE** will be highlighted. Enter the stop degree as 359. Press **ENTER**.

Note: Teams should not input blanking sectors unless directed to do so by a higher authority.

Step 12: Turn system tones **ON/OFF** as desired. Press **ENTER**.

Step 13: Type desired **IN RANGE** distance. Press **ENTER**.

Step 14: Select **STINGER MISSILE ZONE**. Press **ENTER** twice. The **OPTIONS** menu will appear.

Step 15: Select **EMPLACEMENT DATA** using the up or down arrows. Press **ENTER**. **DATUM** will be highlighted.

Step 16: Using the left or right arrow keys, select **WORLD GEODETIC/ WORLD GEODETIC SYSTEM 1984**. Spheroid will be World Geodetic 1984. Press **ENTER**.

Step 17: Type in the site location. Using 1:50,000, enter grid zone designator for map being used. Type 100,000 meter grid square identification. (The grid zone designator and 100,000 meter

MCRP 3-25.10A

square identifier information can be found in the marginal information area at the bottom of a map.)

Step 18: Type current location in 10-digit grid, for example: 12S TB 2790008500. Press ENTER.

Step 19: Type in the data link reference point. Press ENTER.

Step 20: Type in the current site altitude. Press ENTER. Type the site number as required.

Step 21: Type in the CCRP. Press ENTER.

Step 22: Type in the quadrant identifier for northwest, northeast, southwest, and southeast (use color or state two-letter abbreviation [NW, NE, SW, SE]). Press ENTER after each entry.

Step 23: Scroll down using down arrow to **SELECT CCRP**. Using the left or right arrow, select **YES**, press ENTER. The Cartesian grid will be displayed with quadrant identifiers on the **MAIN** screen.

Step 24: Scroll down to **GBDL-E SOURCE**. Select **YES**. Press ENTER twice.

Step 25: Press the **EMPLACEMENT DATA (F12)** key. The RTU is prepared for operation.

Note: The SINGGARS radio must be set to the proper data rate for the RTU to function properly. Ensure the SINGGARS data rate is set at 2,400 bps. To turn the RTU off, press **ALT** and **OFF** keys simultaneously. Stations transmitting GBDL-E should remain in the frequency hop master setting on the AN/PRC-119, this will enable receiving stations to maintain synchronization with the net control station. All receiving stations remain in frequency hop mode.

The TRACK box will appear on a team's RTU only when a section leader or other appropriate higher authority sends an engagement command over GBDL-E to a specific team, and that team then quick hooks the target and will comply with the engagement order.

Common symbology used with the RTU will be displayed on the laptop screen. (See figure G-1.) Training at the team and section levels should be conducted to support rapid recognition of these symbols.

MCRP 3-25.10A

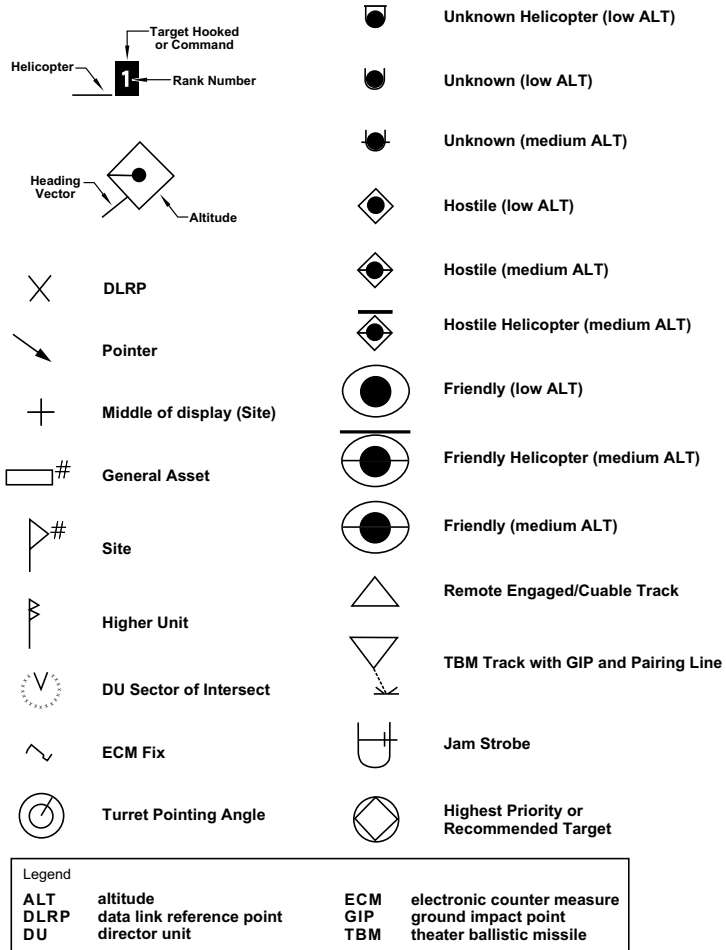

Figure G-1. Remote Terminal Unit Symbology.

Appendix H

AN/PSN-13 Defense Advanced Global Positioning System Receiver

This appendix covers basic tasks necessary to use the DAGR in the basic operating mode only.

POWER ON UNSURE

When position data fields blink between black and gray text, the DAGR is not tracking satellites or has not yet acquired present position. Field data may be inaccurate when the DAGR does not have a position fix. Do not use the DAGR if power on self-test fails. To turn power on, perform the following steps:

Step 1: Push PWR/QUIT to turn the DAGR on. The POWER ON status message shows for two seconds, then times out if the self-test has passed and the DAGR does not need initialization. If not, push (WP)/ENTER key to acknowledge.

Notes: If a CV key, GUV key, or SKY VIEW (SV) code condition exists, acknowledge messages accordingly.

The DAGR displays the SV page and then automatically switches to the PRESENT POSITION page when current position is acquired.

If keypad/display lighting is required, toggle lighting on and off by pushing and holding the MENU key.

Step 2: Adjust keypad/display brightness level by simultaneously pushing and holding the MENU key and using the up arrow and down arrow keys.

Power On and Commanded Self-Test

During power up, the DAGR performs an automatic power on self-test. The operator may also choose a commanded self-test that requires approximately 4 minutes to complete. To self-test, perform the following:

Step 1: Activate commanded DAGR self-test. From any display, except a message pop-up, push and hold the POS/PAGE key until the PRESENT POSITION page is displayed.

Step 2: Push the MENU key.

Step 3: Highlight SELECT OP MODE, then push the WP/ENTER key.

Step 4: Highlight TEST, then push the WP/ENTER key. The DAGR displays a message prompting the operator to confirm or cancel entering test mode.

Step 5: Push the WP/ENTER key to confirm. The TEST IN PROGRESS display appears with specific area of testing listed at the bottom and a bar graph denoting progress. The DAGR automatically progresses to next test.

Note: While doing the following keypad test, push and hold the WP/ENTER key to test the WP/ENTER key.

Step 6: Push and release the WP/ENTER key to advance to the next test. KEYPAD TEST is displayed.

Step 7: Push each key on the keypad and verify the corresponding key shown on the display toggles between normal and highlighted appearance.

Step 8: Push and release the WP/ENTER key to continue. The display LIGHT TEST DISPLAY appears with the brightness adjustment cycling between 0 and 100 percent.

Step 9: Verify the display lighting by viewing the DAGR display in a dark area. Push the WP/ENTER key to continue. The CONTRAST TEST DISPLAY appears with the contrast adjustment cycling between 0 and 100 percent.

Step 10: Push the WP/ENTER key to continue. The DISPLAY TEST BEGINNING message appears momentarily. The display sequences through white, light gray, dark gray, and black shading. The DISPLAY TEST COMPLETED message appears, followed immediately by a POWER ON STATUS display listing self-test results.

Step 11: Push the WP/ENTER key to return to the SV page.

Note: The DAGR automatically switches to the standby mode of operation.

Mode of Operation

Continuous is the normal operating mode for external power. Fix is the normal initial operating mode when operating on battery power. The primary modes of operation are—

- **Continuous.** Tracks satellites to produce a continuous position, velocity, time solution, and uses the most power.

MCRP 3-25.10A

- **Fix.** Tracks satellites to produce a current position, velocity, time solution, and then automatically transitions to standby mode after a position fix is obtained.
- **Standby.** Operates at reduced power and does not acquire and track satellites, but performs all functions that do not require satellites.

Average, time only, rehearsal, test, and off are other available modes. Perform the following procedures to select the operating mode:

Step 1: Push and hold the POS/PAGE key until the PRESENT POSITION page is displayed, from any display except a message pop-up.

Step 2: Push the MENU key.

Step 3: Highlight SELECT OP MODE, then push the WP/ENTER key.

Step 4: Highlight the desired operating mode, then push the WP/ENTER key. Display returns to the PRESENT POSITION page, displaying the selected operation mode.

Power Off

Push and hold the PWR/QUIT key on the DAGR. The POWER DOWN WARNING is displayed (if auto-on, auto-mark, or off mode display heater functions are enabled, a message appears prior to the power down warning). Wait the allotted time for the DAGR to turn off or push the WP/ENTER key to immediately turn off the DAGR.

RECEIVER SETUP (MANUAL INITIALIZATION)

Manual initialization is required when—

- Data fields blink between black and gray text, the DAGR is not tracking satellites or acquired current position. Field data may be inaccurate when the DAGR does not have a position fix.
- The DAGR has been moved between two different geographical locations and is not performing correctly; the DAGR may need to be initialized according to the DAGR's current location.

The DAGR PRESENT POSITION page fields must be edited when DAGR is having difficulty obtaining a position fix, the datum is mismatched with navigation waypoints (depicted as WP on the key pad), or the datum does not match the geographical map used. The following procedures describe how to initially setup the DAGR PRESENT POSITION page fields and edit field content:

Step 1: Power the DAGR on.

Step 2: Push and hold the POS/PAGE key to access the PRESENT POSITION page.

Step 3: Select DATUM. From the PRESENT POSITION page, push the MENU key.

Step 4: Highlight SELECT DATUM, then push the WP/ENTER key.

Step 5: Scroll using the up and down arrow keys to select the datum corresponding to the geographical map being used, then

MCRP 3-25.10A

push WP/ENTER key. Display returns to the PRESENT POSITION page with datum change made.

Step 6: Select COORDINATE/GRID SYSTEM from the PRESENT POSITION page, then push the MENU key.

Step 7: Highlight SELECT COORD/GRID, then push the WP/ENTER key.

Step 8: Scroll using the up and down arrow keys to select the coordinate/grid system corresponding to the geographical map being used, then push the WP/ENTER key. Display returns to the PRESENT POSITION page with coordinate/grid system change made.

Step 9: Select units of measure or references (as required). From the PRESENT POSITION, push the WP/ENTER, then highlight elevation field, then push the MENU key.

Step 10: Highlight SELECT ELEV UNITS, then push the WP/ENTER key.

Step 11: Choose the appropriate unit of measure, then push the WP/ENTER key. Display returns to the PRESENT POSITION page with change made.

Step 12: Edit ground speed and track fields in similar manner.

Step 13: Configure initialization data (position, time, speed, and track).

Note: Entering data may not be necessary if current almanac is available.

Step 14: Push the WP/ENTER key, from the PRESENT POSITION page, then use the up/down and left/right keys to scroll through and view fields as desired. If required, edit field content to configure initialization data for current geographical location.

Step 15: Push the WP/ENTER key when desired field is highlighted. An editor appears. For list editors, select the desired field content and push the WP/ENTER key. For text or numeric editors, use the up/down and left/right keys and standard alphanumeric editor functions.

Step 16: Push the WP/ENTER key to save numeric changes or select SAVE when finished with text changes. Display returns to the PRESENT POSITION page with changes made to field content.

Step 17: Select CONTINUOUS OP MODE from the PRESENT POSITION page then push the MENU key.

Step 18: Highlight SELECT OP MODE, then push the WP/ENTER key.

Step 19: Highlight CONTINUOUS, then push the WP/ENTER key. If a message is displayed instructing the operator that initialization is required, push the WP/ENTER key. Display returns to the PRESENT POSITION page with operating mode change made. If PRESENT POSITION page is not already displayed, push and hold the POS/PAGE key until PRESENT POSITION is obtained.

Step 20: Push POS/PAGE the key until SV page is obtained. Satellite acquisition can be monitored from this page.

ACQUIRE CURRENT POSITION

The DAGR obtains current position by simply turning the DAGR on with an open view of the sky. While acquiring satellites, DAGR displays the SV page. After satellites are acquired, DAGR automatically transitions to the PRESENT POSITION page with current position coordinates shown. An indication of when the DAGR has obtained current position is provided by:

- Position data fields of the PRESENT POSITION page remain solid black text and do not blink.
- On the SV page, solid black horizontal bars indicate satellites being tracked and data is collected and NAVIGATING shows at the top of display.

Position Page Set

The POS pages set contains commonly used pages and are described as follows. Use the POS/PAGE key or PWR/QUIT key to scroll pages.

Present Position Page

PRESENT POSITION page displays PRESENT POSITION COORDINATES, COORDINATE AND GRID SYSTEM, DATUM IDENTIFIER, CURRENT OPERATIONS MODE, ESTIMATED HORIZONTAL ERROR, FIGURE OF MERT, ELEVATION, ELEVATION REFERENCE, GROUND SPEED, TRACK, ESTIMATED TIME ERROR, TIME FIGURE OF MERIT, TIME AND DATE, MAGNETIC CARIATION, MAGNETIC MODEL YEAR, and OPERATOR ID. Scroll the page vertically to view all field data.

Situational Awareness Page

Range circles are not shown on display when a vector map is loaded into the DAGR. The SITUATIONAL AWARENESS page provides a graphical display of relationships between present position, track, waypoint, routes, and alerts. This page includes a north reference indicator, ground speed, track, position error data, and a range scale.

Navigation Pointer Page

The NAVIGATION POINTER page displays a pointer directing the operator towards the displayed waypoint. It also displays current navigation method; destination waypoint number; and name, azimuth, and range information.

Image Viewer Page

Image viewer page displays images or maps including current position (shown at center of display), landmarks, map objects, and selected waypoints. The operator uses zoom, pan, waypoint operations, and map selections to obtain desired view. The current position map is automatically displayed when loaded.

Sky View Page

The SV page displays status information on tracked satellites with the current operating status shown at the top of the display. Numbers inside black circles indicate satellites in use by the DAGR, with corresponding number at left side of display. A bar graph of each satellite indicates signal strength and code status. A long black bar indicates good signal strength and ephemeris data. A thick black bar indicates receiving Y or P code. If the DAGR is unable to display satellite information, no bars appear at all.

WAYPOINTS

Waypoint Operations

Waypoint is position information used to navigate through terrain, define routes or navigation alerts, mark present or remote positions, or marking observation points and landmarks.

Mark Present Position Waypoint

To mark the present position waypoint perform the following:

Step 1: Push and hold the WP/ENTER key from any display.

Step 2: Select MARK A WP, then push the WP/ENTER. The MARK PRESENT POSITION message will be displayed.

Step 3: Push the WP/ENTER key to store the marked waypoint. A WAYPOINT STORED message is briefly displayed.

Step 4: Push the WP/ENTER key to acknowledge or just let display time out. Display returns to previously viewed display.

Create a New Waypoint

To create a new waypoint perform the following:

Step 1: Push and hold the WP/ENTER key from any display.

Step 2: Highlight CREATE NEW WP, then push the WP/ENTER key. The WAYPOINT EDITOR page is shown. The first unused waypoint is populated with current position information (if tracking satellites).

Step 3: Revise information in all fields as necessary.

Step 4: Push the MENU key.

Step 5: Highlight SAVE AND EXIT, then push the WP/ENTER key. After the waypoint is stored, a WAYPOINT STORED message is briefly displayed.

Step 6: Push the WP/ENTER key to acknowledge or let display time out. Display returns to the WP page with the new waypoint information saved and highlighted.

NAVIGATION

Navigation Operation

Current position is necessary before accurate navigation can be accomplished. The GO TO WP function uses the DIRECT TO navigation method. Navigation information to the selected destination waypoint is automatically displayed using the NAVIGATION POINTER.

Waypoint GO TO Navigation

To perform waypoint navigation execute the following steps:

Step 1: Push and hold the POS/PAGE key from any display except a message pop-up, then the PRESENT POSITION page will be displayed.

Step 2: Push and hold the WP/ENTER key.

MCRP 3-25.10A

Step 3: Highlight GO TO A WP, then push the WP/ENTER key.

Step 4: Scroll through the waypoint name list using the arrow keys to select the desired destination waypoint.

Note: For waypoint selection sorting options, push the MENU key. Select desired option, then push the WP/ENTER key.

Step 5: Push the WP/ENTER key after waypoint selection. The DAGR automatically displays the NAVIGATION POINTER page. The top of the rotating compass dial indicates the current ground track. The display arrow points the azimuth to the destination waypoint. Move in the direction the arrow is pointing to navigate to the destination waypoint.

ALERTS

Alerts are made up of one or more waypoints and are used to notify the operator is approaching or leaving a point, line, or area of significance (e.g., radius distance from a waypoint, defining a line not to be crossed, or minefield area). The primary types of alerts are as follows:

- **Anchor:** circular area defined by a radius from a waypoint. Activates when outside a defined radius.
- **Hazard:** circular area defined by a radius from a waypoint. Activates when inside a defined radius.
- **Buffer zone:** rectangular area defined by two waypoints. Prevents the user from entering a defined area.
- **Corridor:** rectangular area defined by two waypoints. Prevents the user from exiting a defined area.

Other alerts include: area, boundary line/phase line, position error, and time/date.

Perform the following procedures to access the alerts page:

Step 1: Push and hold the POS/PAGE key, from any display except a message pop-up, and the PRESENT POSITION page will be displayed.

Step 3: Push the MENU key twice to access the MAIN MENU.

Step 4: Highlight WAYPOINTS/ROUTES/ALERTS, then push the WP/ENTER key.

Step 5: Highlight ALERTS, then push the WP/ENTER key. The ALERTS page is shown and displays all assigned alerts. Use the arrow keys to view alert information.

For further information regarding AN/PSN-13 DAGR operations see TM 09880C-OR, *Operator's Guide, DAGR Operators Pocket Guide*.

Glossary

Section I. Acronyms and Abbreviations

ADWC	air defense weapons condition
AM	amplitude modulation
A-MANPADS	advanced man-portable air defense system
ATGM	antitank guided missile
BCU	battery coolant unit
BDZ	base defense zone
bps	bits per second
cal	caliber
CBRN	chemical, biological, radiological, and nuclear
CCRP	Cartesian coordinate reference point
COC	combat operations center
COMSEC	communications security
CVT	criticality-vulnerability-threat
DAGR	Defense Advanced Global Positioning System Receiver
DASC	direct air support center

MCRP 3-25.10A

DIRLAUTH. direct liaison authorized
DODIC Department of Defense identification code
DTD. data transfer device
EADS. Expeditionary Air Defense System
ECCM electronic counter countermeasures
°F. degrees Fahrenheit
EOD. explosive ordnance disposal
FHT field handling trainer
FM. Frequency modulation; field manual
FOB. forward operating base
FSCC fire support coordination center
ft. foot/feet
G gravitational force
GBAD ground-based air defense
GBDL-E ground-based data link-enhanced
GPS Global Positioning System
GPU. gas pumping unit
HF high frequency

LAAD Gunner's Handbook

HMMWV	high mobility multipurpose wheeled vehicle
HSI	high-speed interface
Hz	hertz
IADS	integrated air defense system
ID	identification
IFF	identification, friend or foe
IMTS	Improved Moving Target Simulator
in	inch(es)
IR	infrared
IRCCM	infrared counter countermeasures
JP	joint publication
km	kilometer(s)
kbps	kilobits per second
KRP	known reference point
kt	knot(s)
LAAD	low altitude air defense
lb	pound(s)
LOS	line of sight

MCRP 3-25.10A

m	meter(s)
MACCS	Marine air command and control system
MAGTF	Marine air-ground task force
MANPADS	man-portable air defense system
MATC	Marine air traffic control
MATCD	Marine air traffic control detachment
MCCRE	Marine Corps Combat Readiness Evaluation
MCWP	Marine Corps warfighting publication
METT-T	mission, enemy, terrain and weather, troops, and support available-time available
MEZ	missile engagement zone
MHz	megahertz
mm	millimeter(s)
MOPP	mission-oriented protective posture
MOS	military occupational specialty
MRC	missile round container
MRR	minimum-risk route
NAAK	nerve agent antidote kits

NBC	nuclear, biological, and chemical
NiCd	nickel cadmium
nm	nautical mile
NOE	nap-of-the-earth
NUV	negative ultraviolet
NVG	night vision goggle
PLGR	Precision Lightweight Global Positioning System Receiver
psi	pounds per square inch
psig	pounds per square gauge
PTL	primary target line
RCU	remote control unit
RF	radio frequency
RMP	reprogrammable microprocessor
ROE	rules of engagement
RSDL	reactive skin decontamination lotion
RTF	return to forces
RTU	remote terminal unit

MCRP 3-25.10A

SAW.....	surface-to-air weapon
SECNAVINST.....	Secretary of Navy instruction
SHORAD.....	short-range air defense
SINGARS.....	single-channel ground and airborne radio system
SKL.....	Simple Key Loader
SOA.....	state of alert
SOP.....	standing operating procedure
STPT.....	Stinger Troop Proficiency Trainer
SV.....	sky view
TAOC.....	tactical air operations center
TACC.....	tactical air command center (Marine Corps)
T&E.....	traversing and elevating
THT.....	tracking head trainer
T&R.....	training and readiness
TSEC.....	transmission security
TM.....	technical manual
UAS.....	unmanned aircraft system

LAAD Gunner's Handbook

US	United States
UHF.....	ultrahigh frequency
V	volt
VAC.....	volts alternating current
VDC	volts direct current
VHF.....	very high frequency
WCS	weapons control status
WP.....	waypoint
WTI.....	weapons, tactics, and instructor
ZOA.....	zone of action

Section II. Terms and Definitions

active air defense—Direct defensive action taken to destroy, nullify, or reduce the effectiveness of hostile air and missile threats against friendly forces and assets. It includes the use of aircraft, air defense weapons, electronic warfare, and other available weapons. (JP 1-02)

airborne early warning—The detection of enemy air or surface units by radar or other equipment carried in an airborne vehicle, and the transmitting of a warning to friendly units. Also called **AEW**. (JP 1-02)

air defense—Defensive measures designed to destroy attacking enemy aircraft or missiles in the atmosphere, or to nullify or reduce the effectiveness of such attack. Also called **AD**. (JP 1-02)

air defense area—A specifically defined airspace for which air defense must be planned and provided. (JP 1-02, Part 1 of a 2-part definition.)

air defense identification zone—Airspace of defined dimensions within which the ready identification, location, and control of airborne vehicles are required. Also called **ADIZ**. (JP 1-02)

air defense region—A geographical subdivision of an air defense area. (JP 1-02)

air defense sector—A geographical subdivision of an air defense region. (JP 1-02)

air superiority—That degree of dominance in the air battle of one force over another that permits the conduct of operations by the former and its related land, sea, and air forces at a given time

and place without prohibitive interference by the opposing force. (JP 1-02)

air supremacy—That degree of air superiority wherein the opposing air force is incapable of effective interference. (JP 1-02)

air surveillance—The systematic observation of airspace by electronic, visual or other means, primarily for the purpose of identifying and determining the movements of aircraft and missiles, friendly and enemy, in the airspace under observation. (JP 1-02)

amphibious objective area—A geographical area (delineated for command and control purposes in the initiating directive) within which is located the objective(s) to be secured by the amphibious force. This area must be of sufficient size to ensure accomplishment of the amphibious force's mission and must provide sufficient area for conducting necessary sea, air, and land operations. Also called **AOA**. (JP 1-02)

antiair warfare—That action required to destroy or reduce to an acceptable level the enemy air and missile threat. Antiair warfare integrates all offensive and defensive actions against enemy aircraft, surface-to-air weapons, and theater missiles into a singular, indivisible set of operations. It is one of the six functions of Marine aviation. Also called **AAW**. (MCRP 5-12C)

antiair warfare commander—The antiair warfare commander is the antiair warfare agent of the commander, amphibious task force who is responsible for AAW of the amphibious task force in a particular region, (the amphibious objective area), and during its movement to, and arrival in, the amphibious objective area. Also called **AAWC**.

MCRP 3-25.10A

area air defense commander—Within a unified command, subordinate unified command, or joint task force, the commander will assign overall responsibility for air defense to a single commander. Normally, this will be the component commander with the preponderance of air defense capability and the command, control, and communications capability to plan and execute integrated air defense operations. Representation from the other components involved will be provided, as appropriate, to the area air defense commander's headquarters. Also called **AADC**. (JP 1-02)

area of influence—A geographical area wherein a commander is directly capable of influencing operations, by maneuver or fire support systems normally under the commander's command or control. (JP 1-02)

area of responsibility—The geographical area associated with a combatant command within which a geographic combatant commander has authority to plan and conduct operations. Also called **AOR**. (JP 1-02)

BANDIT—Positively identified as enemy in accordance with theater identification criteria. The term does not necessarily imply direction or authority to engage. (MCRP 3-25B)

base defense zone—An air defense zone established around an air base and limited to the engagement envelope of short-range air defense weapon systems defending that base. Base defense zones have specific entry, exit, and identification, friend or foe procedures established. Also called **BDZ**. (JP 10-52)

BOGEY—A radar or visual air CONTACT whose identity is unknown. (MCRP 3-25B)

centralized control—1. In air defense, the control mode whereby a higher echelon makes direct target assignments to fire units. (See also decentralized control.) 2. In joint air operations, placing within one commander the responsibility and authority for planning, directing, and coordinating a military operation or group/category of operations. (JP 1-02)

combat air patrol—An aircraft patrol provided over an objective area, the force protected, the critical area of a combat zone, or in an air defense area, for the purpose of intercepting and destroying hostile aircraft before they reach their targets. Also called **CAP**. (JP 1-02)

combat information center—The agency in a ship or aircraft manned and equipped to collect, display, evaluate, and disseminate tactical information for the use of the embarked flag officer, commanding officer, and certain control agencies. Also called **CIC**. (JP 1-02)

combat operations center—The primary operational agency required to control the tactical operations of a command that employs ground and aviation combat, combat support, and logistics combat elements or portions thereof. The combat operations center continually monitors, records, and supervises operations in the name of the commander and includes the necessary personnel and communications to do the same. Also called **COC**. (MCRP 5-12C)

command and control—The exercise of authority and direction by a properly designated commander over assigned and attached forces in the accomplishment of the mission. Command and control functions are performed through an arrangement of personnel, equipment, communications, facilities, and procedures employed by a commander in planning, directing, coordinating,

MCRP 3-25.10A

and controlling forces and operations in the accomplishment of the mission. Also called **C2**. (JP 1-02)

control of aircraft and missiles—The coordinated employment of facilities, equipment, communications, procedures, and personnel that allows the aviation combat element (ACE) commander to plan, direct, and control the efforts of the ACE to support the accomplishment of the Marine air-ground task force mission. Control of aircraft and missiles is one of the six functions of Marine aviation. (MCRP 5-12C)

coordinating altitude—A procedural airspace control method to separate fixed- and rotary-wing aircraft by determining an altitude below which fixed-wing aircraft will normally not fly and above which rotary-wing aircraft normally will not fly. The coordinating altitude is normally specified in the airspace control plan and may include a buffer zone for small altitude deviations. (JP 1-02)

counterair—A mission that integrates offensive and defensive operations to attain and maintain a desired degree of air superiority. Counterair missions are designed to destroy or negate enemy aircraft and missiles, both before and after launch. (JP 1-02)

crossover zone (crossover point)—That range in the air warfare area at which a target ceases to be an air intercept target and becomes a surface-to-air missile target. (JP 1-02). Weapons systems making engagements in this zone will normally be under positive control of the TAOC, EW/C, or airborne early warning aircraft. (MCRP 3-25.10A)

decentralized control—In air defense, the normal mode whereby a higher echelon monitors unit actions, making direct

target assignments to units only when necessary to ensure proper fire distribution or to prevent engagement of friendly aircraft. (JP 1-02)

detection—In surveillance, the determination and transmission by a surveillance system that an event has occurred. (JP 1-02, Part 2 of a 4-part definition)

direct air support center—The principal air control agency of the US Marine air command and control system responsible for the direction and control of air operations directly supporting the ground combat element. It processes and coordinates requests for immediate air support and coordinates air missions requiring integration with ground forces and other supporting arms. It normally collocates with the senior fire support coordination center within the ground combat element and is subordinate to the tactical air command center. Also called **DASC**. (JP 1-02)

electronic protection—Division of electronic warfare involving actions taken to protect personnel, facilities, and equipment from any effects of friendly or enemy use of the electromagnetic spectrum that degrade, neutralize, or destroy friendly combat capability. Also called **EP**. (JP 1-02)

electronic warfare—Military action involving the use of electromagnetic and directed energy to control the electromagnetic spectrum or to attack the enemy. Electronic warfare consists of three divisions: electronic attack, electronic protection, and electronic warfare support. Also called **EW**. (JP 1-02).

electronic warfare support—Division of electronic warfare involving actions tasked by, or under direct control of, an operational commander to search for, intercept, identify, and locate or localize sources of intentional and unintentional radiated electro-

magnetic energy for the purpose of immediate threat recognition, targeting, planning and conduct of future operations. Also called **ES**. (JP 1-02)

emission control—The selective and controlled use of electromagnetic, acoustic, or other emitters to optimize command and control capabilities while minimizing, for operations security: a. detection by enemy sensors; b. mutual interference among friendly systems; and/or c. enemy interference with the ability to execute a military deception plan. Also called **EMCON**. (JP 1-02)

fighter engagement zone—In air defense, that airspace of defined dimensions within which the responsibility for engagement of air threats normally rests with fighter aircraft. Also called **FEZ**. (JP 1-02)

fire support coordination center—A single location in which are centralized communications facilities and personnel incident to the coordination of all forms of fire support. Also called **FSCC**. (JP 1-02)

forward operating base—An airfield used to support tactical operations without establishing full support facilities. The base may be used for an extended time period. Support by a main operating base will be required to provide backup support for a forward operating base. Also called **FOB**. (JP 1-02)

high-altitude missile engagement zone—In air defense, that airspace of defined dimensions within which the responsibility for engagement of air threats normally rests with high-altitude surface-to air missiles. Also called **HIMEZ**. (JP 1-02)

hostile—In combat and combat support operations, an identity applied to a track declared to belong to any opposing nation party, group, or entity, which by virtue of its behavior or information

collected on it such as characteristics, origin, or nationality contributes to the threat to friendly forces. (JP 1-02)

joint engagement zone—In air defense, that airspace of defined dimensions within which multiple air defense systems (surface-to-air missiles and aircraft) are simultaneously employed to engage air threats. Also called **JEZ**. (JP 1-02)

LAME DUCK—An aircraft in a minor state of emergency. (MCRP 3-25B)

low-altitude missile engagement zone—In air defense, that airspace of defined dimensions within which the responsibility for engagement of air threats normally rests with low- to medium-altitude surface-to-air missiles. Also called **LOMEZ**. (JP 1-02)

low level transit route—A temporary corridor of defined dimensions established in the forward area to minimize the risk to friendly aircraft from friendly air defenses or surface forces. Also called **LLTR**. (JP 1-02)

Marine air command and control system—A system that provides the aviation combat element commander with the means to command, coordinate, and control all air operations within an assigned sector and to coordinate air operations with other Services. It is composed of command and control agencies with communications-electronics equipment that incorporates a capability from manual through semiautomatic control. Also called **MACCS**. (JP 1-02) The two major types of control exercised by the Marine air command and control system are:

a. air direction—The guidance and supervision that a commander employs to focus his resources on mission accomplishment. Air direction occurs as a sequence of the following activities:

(1) apportionment (air)—The determination and assignment of the total expected air effort by percentage and/or by priority that should be devoted to the various air operations and/or geographic areas for a given period of time.

(2) allocation (air)—The translation of the air apportionment decision into total numbers of sorties by aircraft type available for each operation or task.

(3) tasking—The process of translating the allocation into orders and passing these orders to the units involved. Each order normally contains sufficient detailed instructions to enable the executing agency to accomplish the mission successfully.

(4) fragmentary order—An abbreviated form of an operation order, usually issued on a day-to-day basis, that eliminates the need for restating information contained in a basic operation order. It may be issued in sections.

b. air control—The authority to effect the maneuver of aircraft. The elements of air control are:

(1) air control agency—An organization possessing the capability to exercise air control.

(2) air controller—An individual especially trained for and assigned the duty of the control (by use of radio, radar, or other means) of such aircraft as may be allotted to him for operation within his area.

(3) airspace control—A process that coordinates, integrated, and regulates the use of an airspace of defined proportions. It does not include measures to approve, disapprove, deny, or delay air operations.

(4) operational control—With respect to a flight, the exercise of authority over initiating, conducting, or terminating a flight.

(5) positive control—The tactical control of aircraft by a designated control unit, whereby the aircraft receives orders affecting its movements that immediately transfer responsibility for the safe navigation of the aircraft to the unit issuing such orders.

(6) procedural control—A method of airspace control that relies on a combination of previously agreed and promulgated orders and procedures.

(7) radar control—The operation of air traffic in a radar environment in which heading, altitude, and airspeed of the aircraft are directed by the control facility and radar separation from other traffic is provided.

(8) terminal control—The authority to direct the maneuver of aircraft that are delivering ordnance, passengers, or cargo to a specific location or target.

minimum-risk route—A temporary corridor of defined dimensions recommended for use by high-speed, fixed-wing aircraft that presents the minimum known hazards to low-flying aircraft transiting the combat zone. Also called **MRR**. (JP 1-02)

missile engagement zone—In air defense, airspace of defined dimensions within which the responsibility for engagement of air threats normally rests with a particular missile weapon system. (JP 1-02 under “weapon engagement zone”)

passive air defense—All measures, other than active air defense, taken to minimize the effectiveness of hostile air and missile threats against friendly forces and assets. These measures include camouflage, concealment, deception, dispersion, reconstitution, redundancy, detection and warning systems, and the use of protective construction. (JP 1-02)

rules of engagement—Directives issued by competent military authority that delineate the circumstances and limitations under which United States forces will initiate and/or continue combat engagement with other forces encountered. Also called **ROE**. (JP 1-02)

short-range air defense engagement zone—In air defense, that airspace of defined dimensions within which the responsibility for engagement of air threats normally rests with short-range air defense weapons. It may be established within a low- or high-altitude missile engagement zone. Also called **SHORADEZ**. (JP 1-02)

surface-to-air guided missile—A surface-launched guided missile for use against air targets. Also called **SAM**. (JP 1-02)

surface-to-air weapon—A surface-launched weapon for use against airborne targets. Examples include missiles, rockets and air defense guns. (JP 1-02)

tactical air command center—The principal US Marine Corps air command and control agency from which air operations and air defense warning functions are directed. It is the senior agency of the US Marine air command and control system that serves as the operational command post of the aviation combat element commander. It provides the facility from which the aviation combat element commander and his battle staff plan, supervise, coordinate, and execute all current and future air operations in support of the Marine air-ground task force. The tactical air command center can provide integration, coordination, and direction of joint and combined air operations. Also called **Marine TACC**. (JP 1-02)

tactical air control center—The principal air operations installation (ship-based) from which all aircraft and air warning functions of tactical air operations are controlled. Also called **Navy TACC**. (JP 1-02)

tactical air direction center—An air operations installation under the overall control of the Navy tactical air control center or the Marine Corps tactical air command center, from which aircraft and air warning service functions of tactical air operations in support of amphibious operations are directed. Also called **TADC**. (JP 1-0)

tactical air operations center—The principal air control agency of the US Marine air command and control system responsible for airspace control and management. It provides real-time surveillance, direction, positive control and navigational assistance for friendly aircraft. It performs real-time direction and control of all anti-air warfare operations, to include manned interceptors and surface-to-air weapons. It is subordinate to the tactical air command center. Also called **TAOC**. (JP 1-02)

unmanned aircraft system—That system whose components include the necessary equipment, network, and personnel to control an unmanned aircraft. Also called **UAS**. (JP 1-02)

weapon engagement zone—In air defense, airspace of defined dimensions within which the responsibility for engagement of air threats normally rests with a particular weapon system. Also called **WEZ**.

References

Joint Publications (JPs)

- | | |
|--------|---|
| 1-02 | Department of Defense Dictionary of Military and Associated Terms |
| 3-01 | Countering Air and Missile Threats |
| 3-09.3 | Close Air Support |

Army Field Manuals (FMs)

- | | |
|---------|--|
| 3-01 | U.S. Army Air and Missile Defense Operations |
| 3-01.11 | Air Defense Artillery Reference Handbook |
| 3-01.80 | Visual Aircraft Recognition |
| 44-1A | US Army Air Defense Artillery Operational Planning |
| 44-18 | Air Defense Artillery Employment Stinger |
| 44-18-1 | Stinger Team Operations |

Army Technical Manuals (TMs)

- | | |
|---------------|---|
| 9-1425-429-12 | Operator's and Organizational Maintenance Manual for Stinger Guided Missile System Consisting of: Weapon Round RMP: FIM-92D (NSN 1425-01-325-0695) (EIC: N/A) (NSN 1425-01-356-6995) (EIC: N/A) (NSN 1425-01- |
|---------------|---|

325-0696) (EIC: N/A) Weapon Round Block I: FIM-92E (NSN 1425-01-440-8040) (EIC: N/A) Trainer Handling Guided Missile Launcher M60 (NSN 6920-01-024-9969) (EIC: NRH) Guided Missile Subsystem Intercept-Aerial, Training M148 (NSN 6920-01-246-0699) (EIC: NSC) Interrogator Set AN/PPX-3A, AN/PPX-3B (NSN 5895-01-032-4263) (EIC: IZH) (NSN 5895-01-126-9263) (EIC: IZF) Interrogator Set Programmer AN/GSX-1, AN/GSX-1A (NSN 5895-01-032-4266) (EIC: IZJ) (NSN 5895-01-119-1273) (EIC: IZK)

9-6920-429-12

Operator's and Organizational Maintenance Manual for Training Set, Guided Missile System M134 NSN 6920-01-024-6946 Training Set, Guided Missile System M160 (RMP) NSN 6920-01-232-2562 Trainer, Captive Flight M67 NSN 6920-01-246-0701 Trainer, Captive Flight Basic NSN 6920-01-305-7525 (Stinger Air Defense Guided Missile System)

9-6920-430-14

Operator's and Organizational Direct Support, and General Support Maintenance Manual Coolant Recharging Unit, Training Guided Missile System M80 6920-01-024-9970 Charger, Battery PP-7309/T 6130-01-024-6922

Marine Corps Warfighting Publications (MCWPs)

3-11.2	Marine Rifle Squad
3-15.1	Machine Guns and Machine Gun Gunnery
3-22	Antiair Warfare
3-24	Assault Support
3-25	Control of Aircraft and Missiles
3-25.3	Marine Air Command and Control System Handbook
3-25.5	Direct Air Support Center Handbook
3-25.10	Low Altitude Air Defense Handbook
3-40.3	MAGTF Communications System

Marine Corps Reference Publication (MCRP)

3-25 B	Multi-Service Brevity Codes (Brevity)
3-25E	Multi-Service Tactics, Techniques, and Procedures for an Integrated Air Defense System (IADS)
5-12C	United States Marine Corps Supplement to the Department of Defense Dictionary of Military and Associated Terms

Marine Corps Technical Manuals (TMs)

08319A-12	Operators and Organizational Maintenance Instructions STLS (Stinger Launch Simulator) NSN 6920-01-119-7619
-----------	--

MCRP 3-25.10A

- 08670A/09712A-10/1B Operator's Manual for Machine Gun, 7.62MM, M240 (1005-01-025-8095); M240B (1005-01-412-3129); M240C (1005-01-085-4758); M240D (1005-01-418-6995); M240E1 (1005-01-252-4288); M240H (1005-01-518-2410); M240L (1005-01-549-5837); M240N (1005-01-493-1666)
- 09688A-10&P Operation and Maintenance Instruction with Parts List AN/PAS-18, Receiver Infrared System Part Number 4006149-1 NSN 6685-01-356-6542
- 09880C-OR Operator's Guide, DAGR Operator's Pocket Guide
- 10296A-10/1-1 Field Handbook Expeditionary Air Defense System (EADS) Director Unit (DU)
- 11133A-OR/A Operator's and Organizational Maintenance Manual Guided Missile Battery Control Center Vehicle Mounted AN/TWQ-2 NSN 1430-01-531-2722
- 11-5810-410-13&P Technical Manual Operators and Field Maintenance Manual Including Repair Parts and Special Tools List for Transfer Unit, Cryptographic Key AN/PYQ-10 (C) Simple Key Loader (SKL) SKL UAS Version 4.0 (NSN 5810-01-517-3587) (EIC: N/A)

Navy/Marine Corps Departmental Publication (NAVMC)

3500.57 Low Altitude Air Defense (LAAD)
Training and Readiness Manual

Secretary of the Navy Instruction (SECNAVINST)

5510.30B Department of the Navy (DON)
Personnel Security Program (PSP)
Instruction

5510.36A Department of the Navy (DON)
Information Security Program (ISP)
Instruction

Navy Technical Manual (TM)

10254A-10/1 AN/CYZ-10(V)3 Data Transfer
Device Operator's Manual
PMW161-DTD-OM-1

Miscellaneous Publications

Michael J. Gething and Gunter Endres, *Jane's Aircraft Recognition Guide* (New York, NY: Harper Collins Publishers)

Naval Communications Security Material System, Andrews Air Force Base, MD, *EKMS-1A Phase 4 CMS Policy and Procedures for Navy Electronic Key Management System Tiers 2 & 3*

To Our Readers

Changes: Readers of this publication are encouraged to submit suggestions and changes to Doctrine Control Branch via e-mail: doctrine@usmc.mil.

Suggestions and changes must include the following information:

- Location of change
 - Publication number and title
 - Current page number
 - Paragraph number (if applicable)
 - Line number
 - Figure or table number (if applicable)
- Nature of change
 - Addition/deletion of text
 - Proposed new text

Additional copies: If this publication is not an electronic only distribution, a printed copy may be obtained from Marine Corps Logistics Base, Albany, GA 31704-5001, by following the instructions in MCBul 5600, *Marine Corps Doctrinal Publications Status*. An electronic copy may be obtained from the United States Marine Corps Doctrine web page:

<https://homeport.usmc.mil/sites/mcdoctrine/SitePages/Home.aspx>